

**CCECC & CRWJ Joint Venture**

**Contract No. HY/2003/19**

**Improvement to Tung Chung Road  
between Lung Tseng Tau and Cheung Sha**

**Bi-Monthly EM&A Report for Ecological  
Mitigation Audit and Landscape & Visual  
Resources Audit (Version 1.1)**

September 2010

Certified By	 _____ (Environmental Team Leader)
--------------	--

REMARKS:

The information supplied and contained within this report is, to the best of our knowledge, correct at the time of printing.

CINOTECH accepts no responsibility for changes made to this report by third parties.

**CINOTECH CONSULTANTS LTD**

Room 1710, Technology Park,  
18 On Lai Street,  
Shatin, NT, Hong Kong

Tel: (852) 2151 2083

Fax: (852) 3107 1388

Email: [info@cinotech.com.hk](mailto:info@cinotech.com.hk)

## TABLE OF CONTENTS

	Page
<b>EXECUTIVE SUMMARY .....</b>	<b>1</b>
<b>1 INTRODUCTION.....</b>	<b>2</b>
Background .....	2
Project Organizations .....	4
Summary of EM&A Requirements.....	4
<b>2 ECOLOGICAL MITIGATION AUDIT.....</b>	<b>5</b>
Schedule for Ecological Mitigation Auditing .....	5
Locations of Ecological Mitigation Measures .....	5
Methods of Ecological Mitigation Auditing .....	5
Results of the Audit.....	5
Improvement works completed in September 2010.....	5
Conclusion and Recommendations for Ecological Mitigation Measures .....	7
Conclusions .....	7
<b>3 LANDSCAPE &amp; VISUAL RESOURCES AUDIT .....</b>	<b>8</b>
Monitoring Requirements .....	8
Mitigation Measures.....	8
Auditing Equipment .....	10
Results of Landscape & Visual Resources Audit.....	10
<b>4 CONCLUSIONS AND RECOMMENDATIONS FOR LANDSCAPE &amp; VISUAL RESOURCES AUDIT.....</b>	<b>11</b>
Conclusions .....	11
Recommendations .....	11



## **LIST OF FIGURES**

Figure 1a-h	Layout Plan of the Project
Figure 2	Organization Chart
Figure 3a-c	Locations of the Wildlife Tunnels and Wildlife Ramps
Figure 4	Landscape Softwork Plan (15 sheets)
Figure 5	Drawing of Roundabout at Cheung Sha

## **LIST OF TABLE**

Table 2.1	Improvement works completed for Wildlife Tunnels
Table 2.2	Discrepancies to Recommendations of the Wildlife Rumps
Table 3.1	Proposed Operation Stage Mitigation Measures
Table 3.2	Operational Phase Audit Checklist
Table 3.3	Rectification Works Completed in Reporting Period

## **LIST OF APPENDICES**

A	Photos of Ecological Mitigation Audit
B	Article from AFCD
C	Photos of Landscaping Works

## **EXECUTIVE SUMMARY**

### **Introduction**

1. This is the 6<sup>th</sup> bi-monthly Environmental Monitoring and Audit (EM&A) Report for ecological mitigation audit and landscape & visual resources audit prepared by Cinotech Consultants Limited for the project “Improvement to Tung Chung Road between Lung Tseng Tau and Cheung Sha” (the Project). This report documents the findings of EM&A Works for ecological mitigation audit and landscape & visual resources audit conducted in September 2010.

### **Ecological Mitigation Audit**

2. Ecological mitigation audit was conducted on 17<sup>th</sup> September 2010. The effectiveness of the ecological mitigation measures were assessed by the sign of usage of the ecological mitigation measures.
3. Improvement of the ecological mitigation measures was completed by the Contractor in reporting period. Details can be referred to Section 2.10.

### **Landscape and Visual Resources Audit**

4. Landscape and visual resources audit was conducted on 17<sup>th</sup> September 2010 by the registered Landscape Architect, Contractor and Environmental Team. No defect was found during the audit.

## 1 INTRODUCTION

### Background

- 1.1 The Project “Improvement to Tung Chung Road between Lung Tseng Tau and Cheung Sha” involves the widening and realignment of Tung Chung Road between Lung Tseng Tau in North Lantau and Cheung Sha in South Lantau. The layout plan of the Project is shown in **Figure 1a-h**.
- 1.2 The scope of the Project includes:
  - (a). widening and realignment of a 3.6 km section of Tung Chung Road (TCR) between Lung Tseng Tau and Pak Kung Au from a single-lane road for two-way traffic to a single two-lane road for two-way traffic with a footpath having a minimum width of 1.6 m, and construction of a 2.6 km long single two-lane road between Pak Kung Au and Cheung Sha, including elevated highway structures of a total length of 750 m, with a footpath of a minimum width of 1.6 m;
  - (b). provision of 21 passing bays/bus-bays along the road and a roundabout at Cheung Sha; and;
  - (c). associated works including road rehabilitation, drainage, utility, environmental mitigation measures, landscaping, slope stabilization, traffic aids, road safety enhancement measures, lighting, traffic control and surveillance system, and electrical and mechanical (E&M) works.
- 1.3 The Environmental Impact Assessment (EIA) Report for the Project was approved on 4<sup>th</sup> July 2002 under the Environmental Impact Assessment Ordinance (EIAO). An Environmental Permit (EP- 170/2003) for the works was also granted on 27 June 2003. Two varied Environmental Permits (EP) (EP-170/2003/B and EP-170/2003/C) were issued in June 2006 and July 2007 respectively. Environmental Monitoring and Audit (EM&A) Manual for the Project was also included as part of the EIA reports in the register. An updated EM&A Manual (Revision C) has been issued on 28<sup>th</sup> April 2006.
- 1.4 Highways Department awarded the construction of the Project to CCECC & CRWJ Joint Venture (being a joint venture of China Civil Engineering Construction Corporation & China Railway Wujia Group Corporation) (hereinafter called “the Contractor”) in June 2004. The construction works commenced on 4<sup>th</sup> November 2004 and have been substantially completed on 30<sup>th</sup> June 2009.
- 1.5 The construction phase environmental monitoring for air quality, construction noise and water quality of the Project was approved by EPD to cease since end of August 2009 (refer to letter from EPD, ref.: EP2/N9/A/56 Pt.20). However, bi-weekly site audit works were still carried out in order to ensure implementation of mitigation measures for remaining maintenance works and to follow-up the previous observation/recommendations.
- 1.6 According to Clause 5.2 in the EM&A Manual, operational phase ecology EM&A shall comprise the audit of the reestablishment of habitat areas and the on-going effectiveness of mitigation measures as appropriate. The operational phase EM&A shall be undertaken during the Contractor’s one year maintenance period.

- 1.7 According to Clause 7.4.2 in the EM&A Manual, operational phase landscape and visual auditing will be restricted to the last 12 months of the establishment works of the landscaping proposals and thus only the items below concerning this period are relevant to the operational phase:
- The extent of the agreed works areas should be regularly checked during the construction phase. Any trespass by the Contractor outside the limit of the works, including any damage to existing trees and woodland shall be prohibited;
  - The progress of the engineering works should be regularly reviewed on site to identify the earliest practical opportunities for the landscape works to be undertaken;
  - All existing trees and vegetation within the study area which are not directly affected by the works are retained and protected;
  - The methods of protecting existing vegetation proposed by the Contractor are acceptable and enforced;
  - Preparation, lifting transport and re-planting operations for any transplanted trees;
  - All landscaping works are carried out in accordance with the specifications;
  - The planting of new trees, shrubs, groundcover, climbers, ferns, grasses and other plants, together with the replanting of any transplanted trees are carried out properly and within right season;
  - All necessary horticultural operations and replacement planting are undertaken throughout the Establishment Period to ensure the healthy establishment and growth of both transplanted trees and all newly established plants.
- 1.8 Cinotech Consultants Limited (Cinotech) was commissioned by the Contractor to undertake the Environmental Team (ET) Services for the Project since 1 September 2006. All environmental and audit works were conducted by Cinotech.
- 1.9 This is the 6<sup>th</sup> bi-monthly Environmental Monitoring and Audit (EM&A) Report for ecological mitigation audit and landscape & visual resources audit evaluating the effectiveness of ecological mitigation measures and the result of landscape & visual resources audit in the Operational Phase of the Project.

### **Project Organizations**

1.10 Different parties with different levels of involvement in the project organization include:

- Project Proponent – Major Works Project Management Office (MWPMO) of Highways Department (HyD)
- Engineer (E) / Engineer's Representative (ER) – Mott MacDonald Hong Kong Limited
- Contractor – CCECC & CRWJ Joint Venture
- Environmental Team (ET) – Cinotech Consultants Limited
- Independent Environmental Checker (IEC) – AECOM Asia Co. Ltd

1.11 The responsibilities of respective parties are detailed in Section 1.5 of the Updated EM&A Manual (Revision C, issued on 28 April 2006) of the Project. The project organization chart is presented in **Figure 2**.

### **Summary of EM&A Requirements**

- 1.12 Operational phase ecology EM&A shall comprise the audit of the reestablishment of habitat areas and the on-going effectiveness of mitigation measures as appropriate. The operational phase EM&A shall be undertaken during the Contractor's one year maintenance period.
- 1.13 The EIA has recommended the EM&A for landscape and visual resources is undertaken during the design, construction and operational phases of the project. The implementation of the mitigation measures recommended by the EIA will be monitored through the site audit programme.
- 1.14 Site inspection for ecological contract works and mitigation for landscape and visual resources shall be undertaken once every two months for a period of one year after the commission of the project. The site inspection was started on November 2009 and will end on September 2010 tentatively. The operational phase EM&A Reports on a bi-monthly basis to be submitted within 10 working days of the end of the reporting period.

## 2 ECOLOGICAL MITIGATION AUDIT

### Schedule for Ecological Mitigation Auditing

- 2.1 Ecological mitigation audit was conducted on 17<sup>th</sup> September 2010. The weather was sunny.

### Locations of Ecological Mitigation Measures

- 2.2 Locations of ecological mitigation measures are shown in **Figure 3a-c**. The measures include wildlife tunnels and wildlife ramps. For ease of reference, the wildlife tunnels and wildlife ramps shown in **Figure 3a, 3b and 3c** are assigned as **A, B and C** respectively.

### Methods of Ecological Mitigation Auditing

- 2.3 The effectiveness of the ecological mitigation measures were assessed by the sign of usage of the ecological mitigation measures by organisms including:
- Observation of organism at the measures;
  - Presence of scats, hair, excretion, body parts of organisms at the measures;
  - Presence of food remains, footprints and claw-print at the measures; and
  - Condition of the measures.
- 2.4 Photos were taken during the audit for record and further investigation.

### Results of the Audit

- 2.5 Photos taken during the ecological mitigation audit is attached in **Appendix A**.
- 2.6 Improvement of the ecological mitigation measures was completed by the Contractor in reporting period. Details can be referred to Section 2.10.
- 2.7 No sign of usage of the ecological mitigation measures by organisms was observed during the audit. The signs of usage include:
- No organism was observed near/at the mitigation measure;
  - No scats, hair, excretion, body parts of organisms was found; and;
  - No food remain, footprint and claw-print at the measures was found.
- 2.8 Notes should be given that the stream, entrance of ramp A, channel B and C were dry while channel A were wet during the audit.
- 2.9 Amphibians are unlikely to be encountered in such dry condition. Underestimation of the effectiveness may be resulted.

### Improvement works completed in September 2010

- 2.10 Improvement works has been completed in September 2010 in accordance to the 'Design of Terrestrial Wildlife Crossing System' (Ref: AF GR CON 21/2) by Agriculture, Fisheries and Conservation Department (AFCD). The article was attached as **Appendix B**. The discrepancies to recommendations and the improvement works were also shown in Table 2.1 and 2.2. Photographic records were attached in **Appendix C**.

**Table 2.1 Improvement works completed for Wildlife Tunnels**

<b>Recommendations</b>	<b>Description</b>	<b>Improvement Works Completed in September 2010</b>	<b>Photo Reference</b>
Increase the accessibility of the wildlife tunnels	Provide inverted net at an angle 30 to 90 degrees at the top of chain link fencing	No bending at the top of the net as the bending will cause danger to cattle when crossing the water channel.	N/A
Improve the substratum and surface condition of the wildlife tunnels	Cover the accessing platform and surface of the wildlife tunnels with natural materials like soil, glass, debris, etc	The accessing platform was covered with soil to provide an environment that match the natural habitat.	(1) ,(5) and(6)
	Flatten the base of the wildlife tunnels	The surface of the wildlife tunnels was flattened with concrete and roughens by crushed stone.	(2) and (4)
	Roughen the surface of the wildlife tunnels		
Reduce avoidance of organisms to the wildlife tunnels	Paint the surface of the wildlife tunnels to mimic a natural corridor	The bottom part of the tunnels was covered by crushed stone to mimic a natural corridor.	(2) and (4)
Others	Add ledge into the wildlife tunnels for allowing organism to pass through the wildlife tunnel when it is filled with water.	The uneven area in the tunnel was filled up by concrete to prevent Standing water within wildlife tunnel.	(2) and (4)
	Clear debris or other impediments in the tunnel	The debris in the tunnels was cleared regularly.	(3)

**Table 2.2 Discrepancies to Recommendations of the Wildlife Ramps**

<b>Recommendations</b>	<b>Description</b>	<b>Reason for Discrepancies to Recommendation</b>	<b>Photo Reference</b>
Increase the accessibility of the wildlife tunnels	Provide inverted net at an angle 30 to 90 degrees at the top of chain link fencing.	- <u>Dry Season:</u> Organism would unlikely to be encountered in such dry condition.	(7)
	Increase the area of the platform at the opening of the wildlife tunnels.	- <u>Wet season:</u> The strong water current comes from the upstream, the organisms would most likely follow the current and pass through the wild tunnels, bending at the top of the net and the widening of the platform may not increase the accessibility of the wildlife tunnels effectively.	(7)
Improve the substratum and surface condition of the wildlife ramps	Cover the surface of the wildlife ramps with natural materials like soil, glass, debris, etc.	The strong water current from the upstream will remove the soil/glass/debris in wet season.	(8)

### Conclusion and Recommendations for Ecological Mitigation Measures

#### Conclusions

- 2.11 The ecological mitigation measures were improved in reporting period to help organism moving across constructed road in this ecological mitigation audit.
- 2.12 Time would be needed for amphibians to accommodate the changes on the ecological mitigation measures, underestimation of the effectiveness may be resulted.



### 3 LANDSCAPE & VISUAL RESOURCES AUDIT

#### Monitoring Requirements

- 3.1 Site inspections for the landscape and visual resources should be undertaken at least once every two months during the operational phase.

#### Mitigation Measures

- 3.2 Operational phase auditing will be restricted to the last 12 months of the establishment works of the landscaping proposals and thus only the items below concerning this period are relevant to the operational phase:
- The extent of the agreed works areas should be regularly checked during the construction phase. Any trespass by the Contractor outside the limit of the works, including any damage to existing trees and woodland shall be prohibited;
  - The progress of the engineering works should be regularly reviewed on site to identify the earliest practical opportunities for the landscape works to be undertaken;
  - All existing trees and vegetation within the study area which are not directly affected by the works are retained and protected;
  - The methods of protecting existing vegetation proposed by the Contractor are acceptable and enforced;
  - Preparation, lifting transport and re-planting operations for any transplanted trees;
  - All landscaping works are carried out in accordance with the specifications;
  - The planting of new trees, shrubs, groundcover, climbers, ferns, grasses and other plants, together with the replanting of any transplanted trees are carried out properly and within right season;
  - All necessary horticultural operations and replacement planting are undertaken throughout the Establishment Period to ensure the healthy establishment and growth of both transplanted trees and all newly established plants.
- 3.3 In accordance with the condition of EP-170/2003, the following mitigation measures shall be undertaken:
- A landscape plan including the measures of grass hydroseeding of slopes, landscape and compensatory planting, architectural and chromatic treatment of new road structures, bridges structures, abutments and retaining walls shall be prepared;
  - Native shrub and woodland species shall be planted on the roadside areas affected by the Project to compensate the loss of shrub and woodland vegetation during construction; and
  - Planting of about 25 hectares shall be implemented.
- 3.4 The measures for operation stages as recommended in the EIA is summarized in Table 3.1 and the broad scope of the audit is details above but should also undertaken with reference to the specific checklist provided in Table 3.2.

**Table 3.1 Proposed Operation Stage Mitigation Measures**

<b>ID No.</b>	<b>Mitigation Measure</b>
OM1	Planting of native shrub species on newly formed and upgraded roadside slopes and areas disturbed by the Works to compensate for shrub vegetation lost during construction.
OM2	Planting of native woodland species on newly formed and upgraded roadside slopes and areas disturbed by the Works to compensate for woodland vegetation lost during construction.
OM3	Infill planting of native trees in areas of existing low shrub adjacent to the road, to mitigate for loss of landscape resource and character, for visual screening and to enhance ecological diversity
OM4	Tree and shrub planting to screen the road, to provide visual interest and to provide shade and shelter.
OM5	Sensitive architectural and chromatic treatment of new road structures, bridge structures, abutments, retaining walls
OM6	Sensitive architectural and chromatic treatment of noise barriers

**Table 3.2 Operational Phase Audit Checklist**

<b>ID No.</b>	<b>Area of Works</b>	<b>Mitigation Measure</b>
OM1	Plant supply	Monitoring of operations relating to the supply of specialist plant material (including the collecting, germination and growth of plants from seed) to ensure that plants will be available in time to be used within the construction works. The performance of hydroseeding including the duration to be required for the seed germination and percentage cover of grasses after germination will be monitored by the Contractor.
OM1,2,3&4	Soiling, planting, etc.	Monitoring of implementation and maintenance of soiling and planting works and against possible incursion, physical damage, fire, pollution, surface erosion, etc.
OM5&6	Architectural treatment of retaining walls, elevated road structures and other engineering works.	Implementation and maintenance of mitigation measures, to ensure compliance with agreed designs.
OM5&6	Establishment Works	Monitoring of implementation of maintenance operations during establishment period.

**Auditing location**

- 3.5 The landscape and visual resources audit is conducted along the section of Tung Chung Road shown in **Figure 4**. Drawing of the Roundabout at Cheung Sha is shown in **Figure 5**.

**Auditing Equipment**

- 3.6 A digital camera was used for the landscape and visual resources audit to take photos of the condition of the audited areas.

**Results of Landscape & Visual Resources Audit**

- 3.7 The landscape and visual resources audit was conducted on 17<sup>th</sup> September 2010 by the registered Landscape Architect, Contractor and ET.
- 3.8 The photos of the landscaping works are shown in **Appendix C**.
- 3.9 The rectification works completed in reporting period were summarized in Table 3.3.

**Table 3.3 Rectification Works Completed in Reporting Period**

Rectification Works Completed in Reporting Period	Photo References of Improved Area
Hydroseeding along Tung Chung Road	8, 10, 16, 24, 26 and 28

- 3.10 No landscape defect was found on landscape planting works.

#### **4 CONCLUSIONS AND RECOMMENDATIONS FOR LANDSCAPE & VISUAL RESOURCES AUDIT**

##### **Conclusions**

- 4.1 Further to the site visit, it is confirmed that the landscape works as stipulated in Condition 3.21 of the Environmental Permit No. EP-170/2003 was satisfactorily under Contract No. HY/2003/19.

##### **Recommendations**

- 4.2 No recommendations are considered necessary for the landscape and visual resources mitigation.

---

---

**FIGURE(s)**

---

---

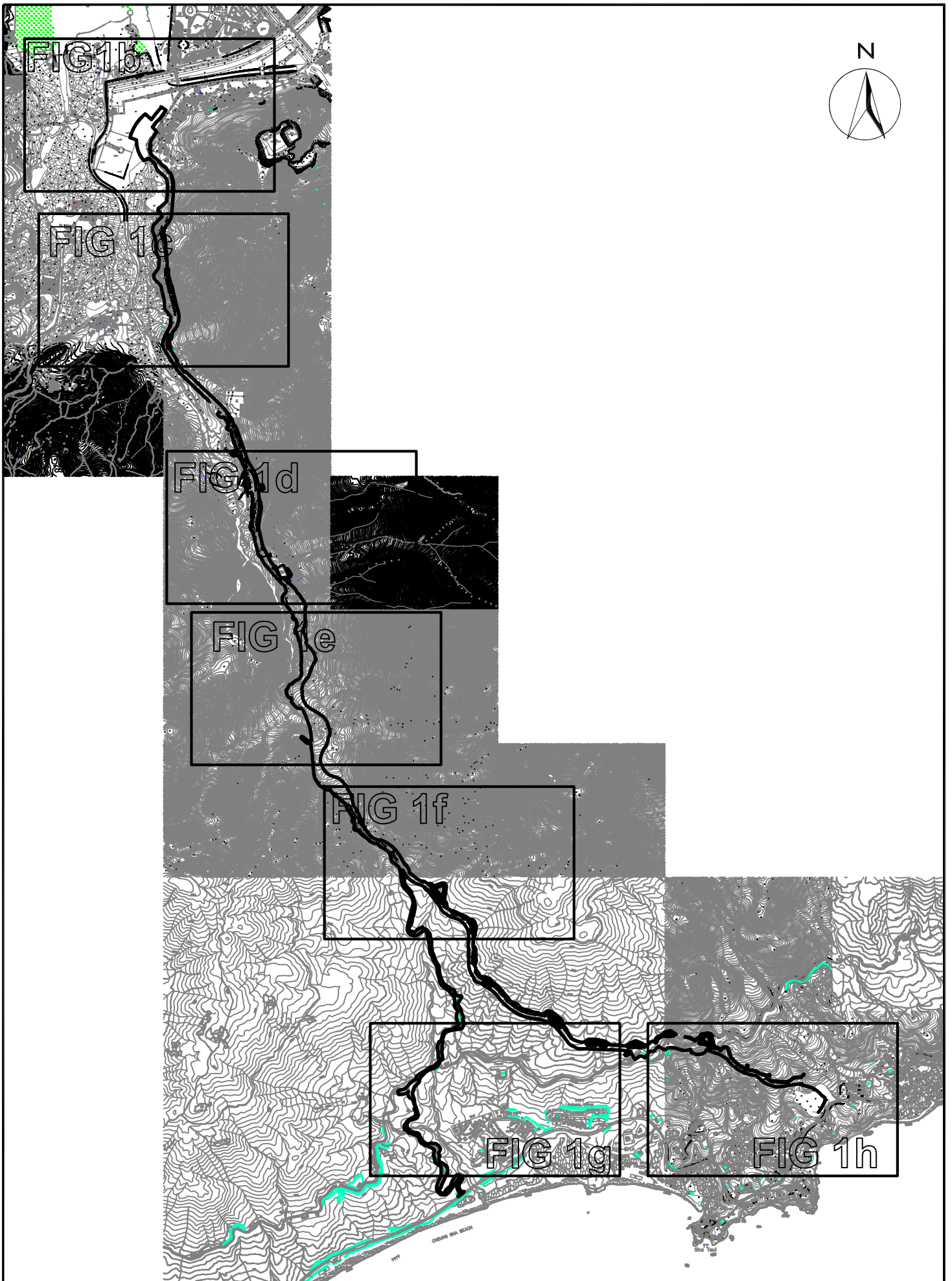

SCALE	N.T.S.	DATE	JAN 2010
CHECK	KC	DRAWN	MF
JOB No.	MA6030	DRAWING No.	FIG 1a
		REV	—





LEGEND			
		Site Boundary	



IMPROVEMENT TO TUNG CHUNG ROAD BETWEEN LUNG  
 TSENG TAU AND CHEUNG SHA  
 MONITORING LOCATIONS

SCALE	A4 1:4000	DATE	JAN 2010	
CHECK	KC	DRAWN	MF	
JOB No.	MA6030	DRAWING No.	FIG 1b	REV 1



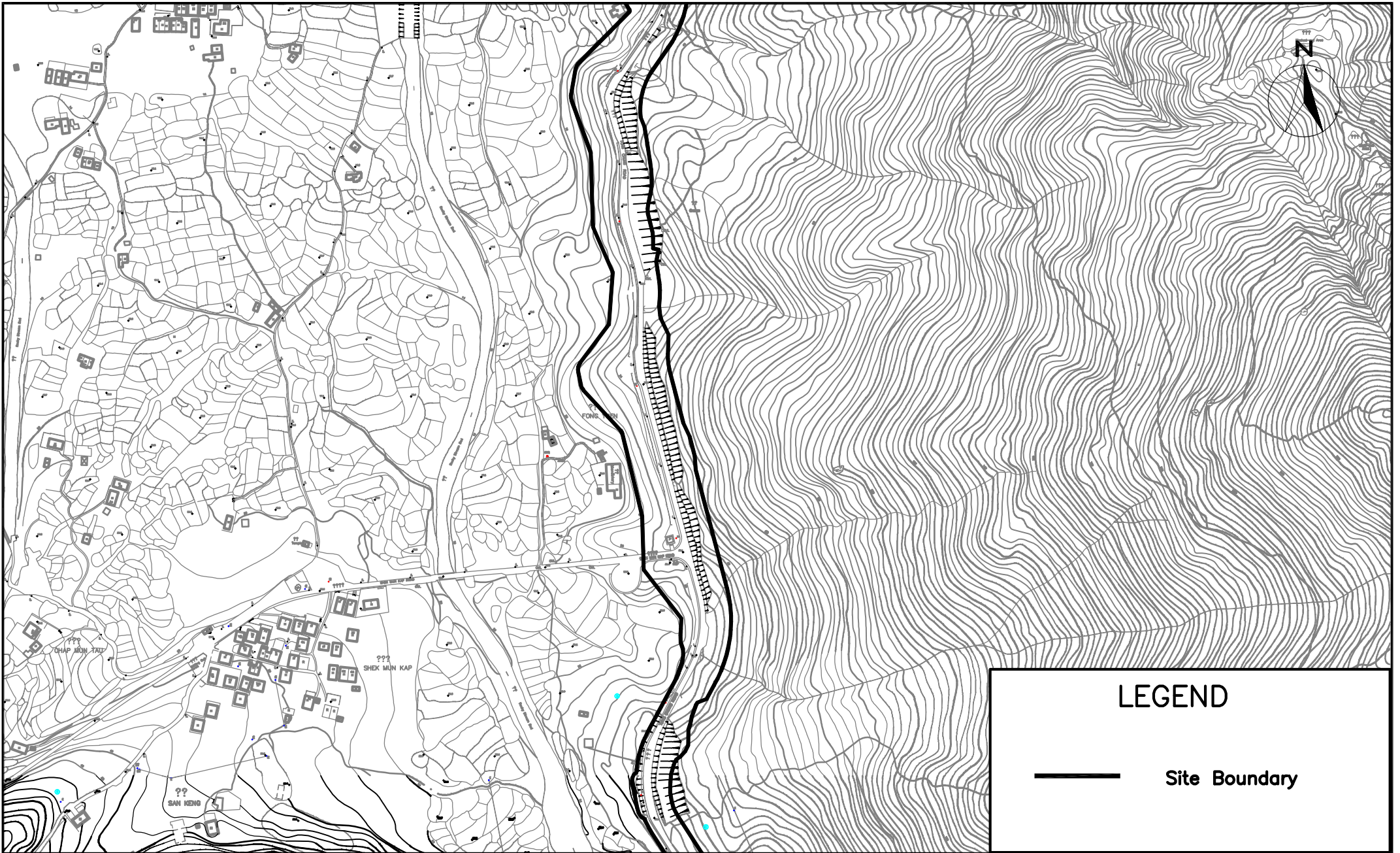

LEGEND			
		Site Boundary	



IMPROVEMENT TO TUNG CHUNG ROAD BETWEEN LUNG  
 TSENG TAU AND CHEUNG SHA  
 MONITORING LOCATIONS

SCALE	A4 1:4000	DATE	JAN 2010	
CHECK	KC	DRAWN	MF	
JOB No.	MA6030	DRAWING No.	FIG 1c	REV 1



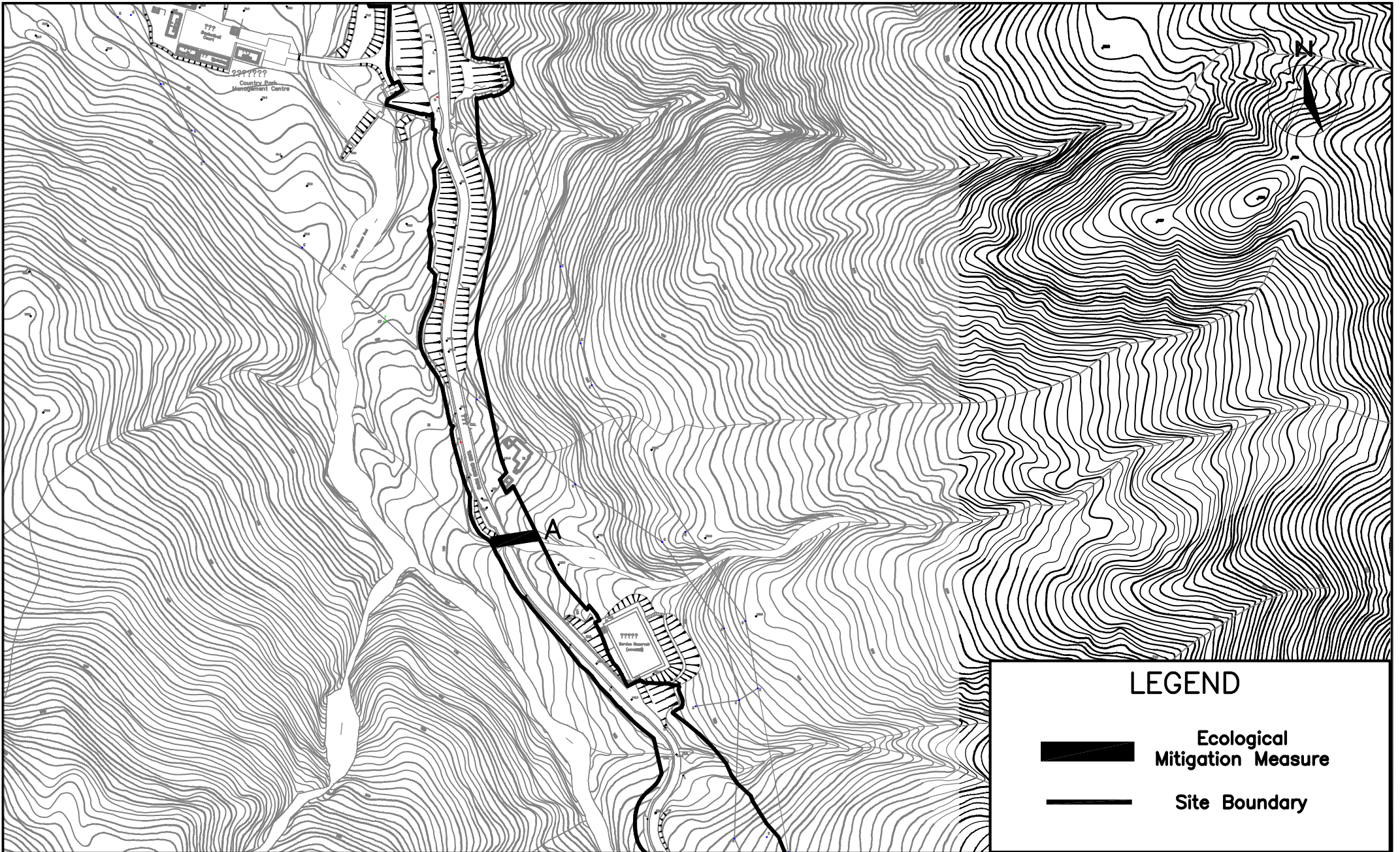

### LEGEND

-  Ecological Mitigation Measure
-  Site Boundary

IMPROVEMENT TO TUNG CHUNG ROAD BETWEEN LUNG  
 TSENG TAU AND CHEUNG SHA  
 MONITORING LOCATIONS



SCALE	A4 1:4000	DATE	JAN 2010
CHECK	KC	DRAWN	MF
JOB No.	MA6030	DRAWING No.	FIG 1d
		REV	1



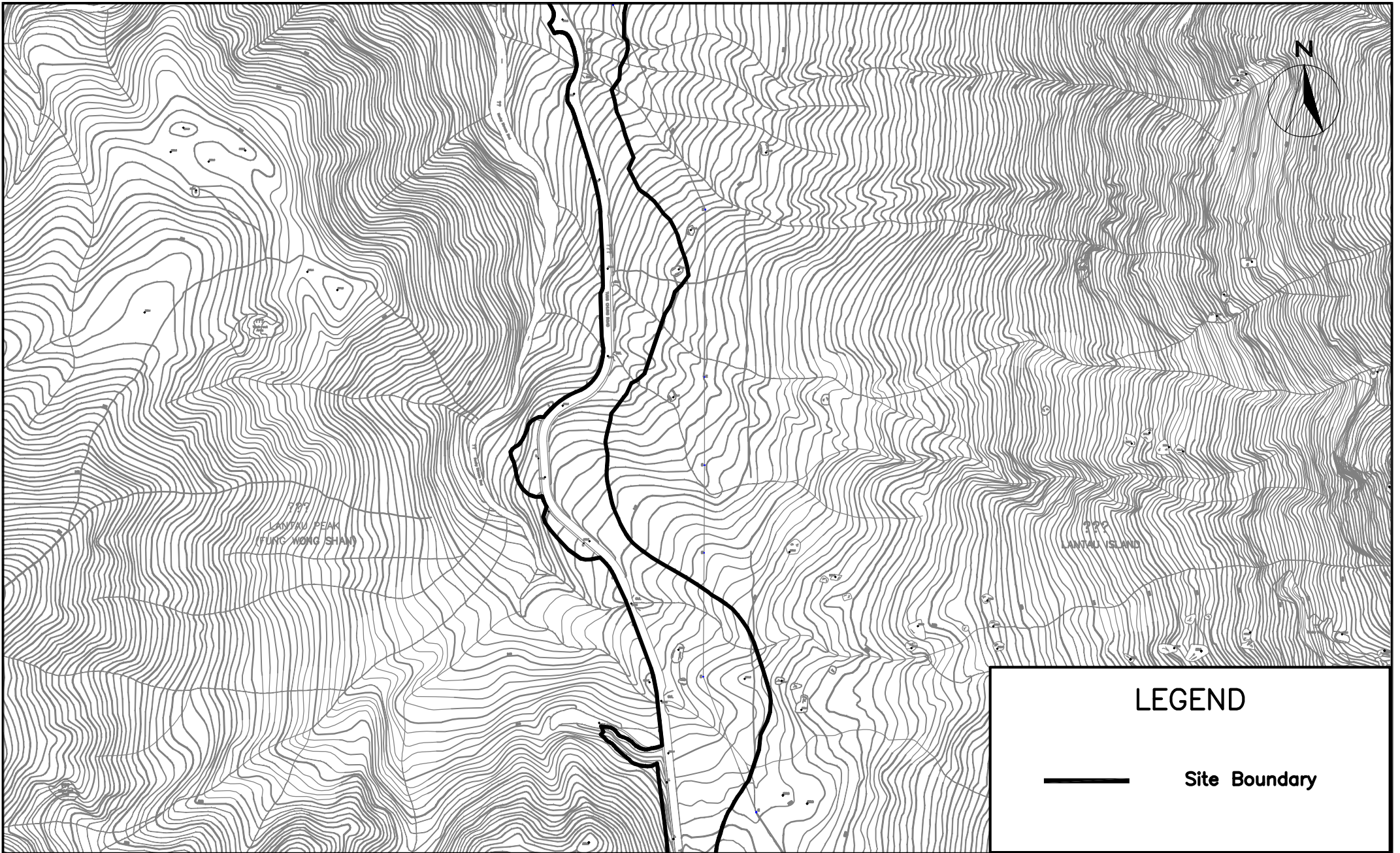

<b>LEGEND</b>			
		<b>Site Boundary</b>	



IMPROVEMENT TO TUNG CHUNG ROAD BETWEEN LUNG  
 TSENG TAU AND CHEUNG SHA  
**MONITORING LOCATIONS**

SCALE	A4 1:4000	DATE	JAN 2010
CHECK	KC	DRAWN	MF
JOB No.	MA6030	DRAWING No.	FIG 1e
		REV	1



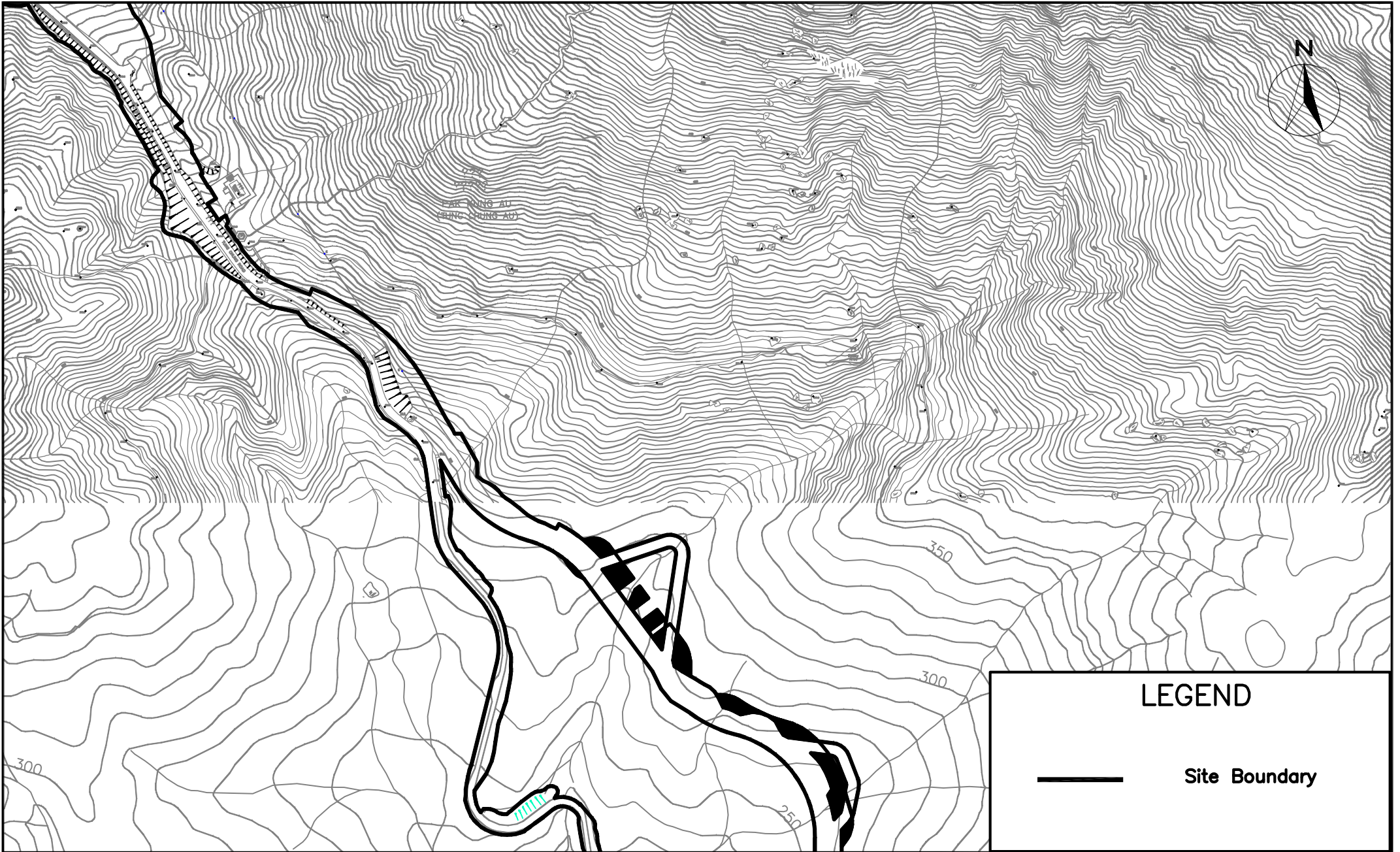

### LEGEND

— Site Boundary



IMPROVEMENT TO TUNG CHUNG ROAD BETWEEN LUNG  
TSENG TAU AND CHEUNG SHA  
MONITORING LOCATIONS

SCALE	A4 1:4000	DATE	JAN 2010
CHECK	KC	DRAWN	MF
JOB No.	MA6030	DRAWING No.	FIG 1f
		REV	1

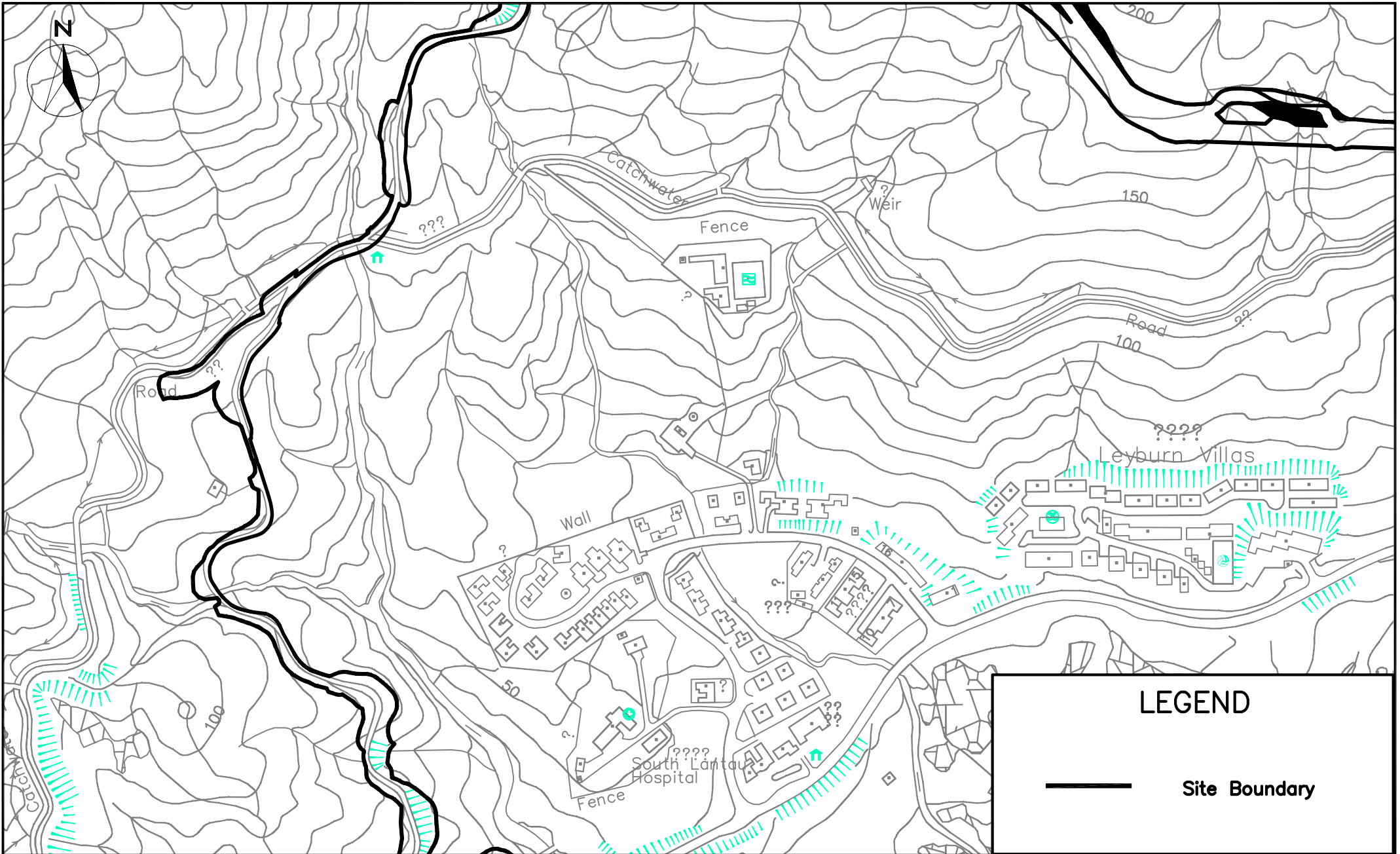

LEGEND			
		Site Boundary	

IMPROVEMENT TO TUNG CHUNG ROAD BETWEEN LUNG  
 TSENG TAU AND CHEUNG SHA  
 MONITORING LOCATIONS



SCALE	A4 1:4000	DATE	JAN 2010
CHECK	KC	DRAWN	MF
JOB No.	MA6030	DRAWING No.	FIG 1g
		REV	1



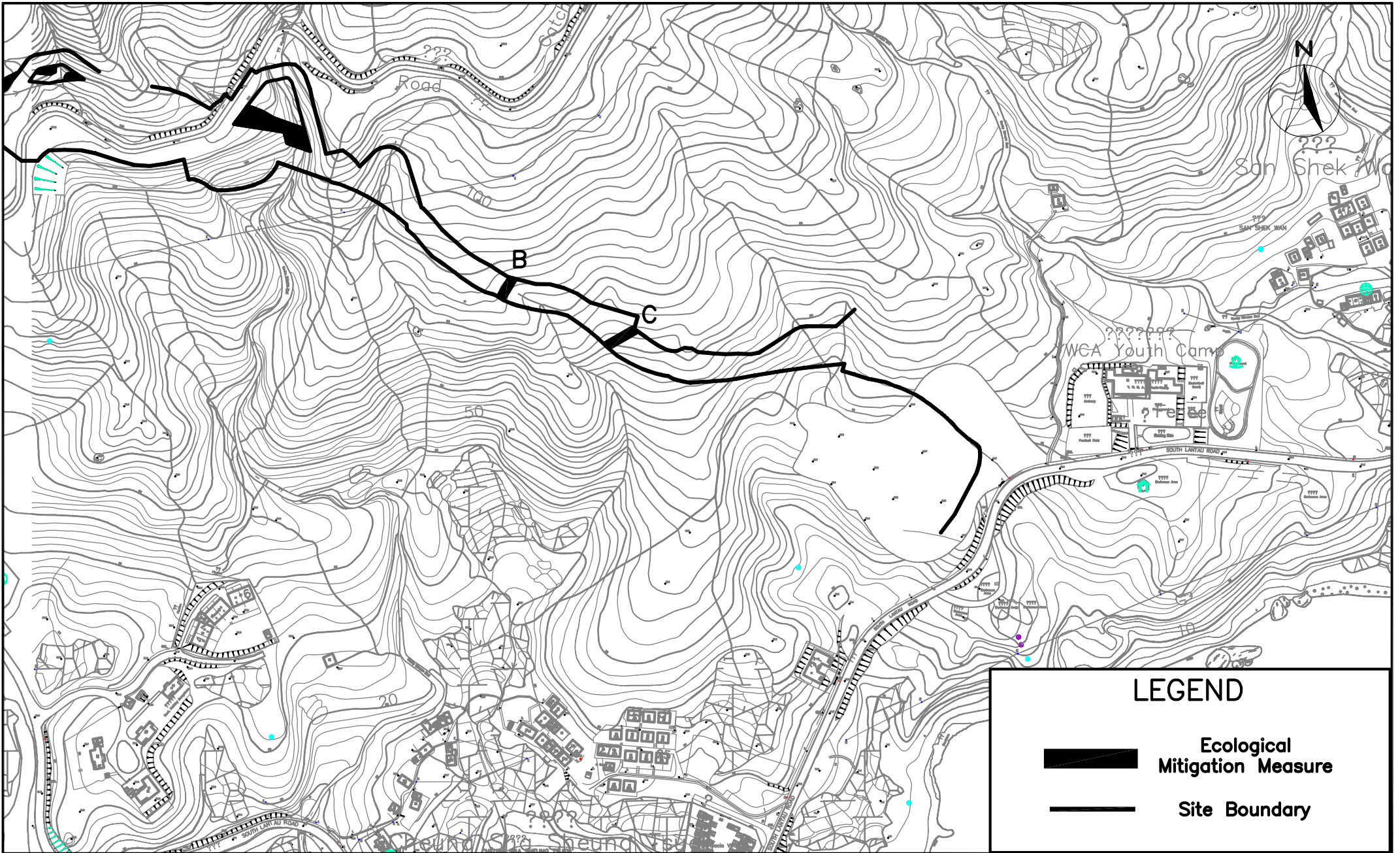

IMPROVEMENT TO TUNG CHUNG ROAD BETWEEN LUNG  
 TSENG TAU AND CHEUNG SHA  
 MONITORING LOCATIONS



SCALE	A4 1:4000	DATE	JAN 2010	
CHECK	KC	DRAWN	MF	
JOB No.	MA6030	DRAWING No.	FIG 1h	REV 1

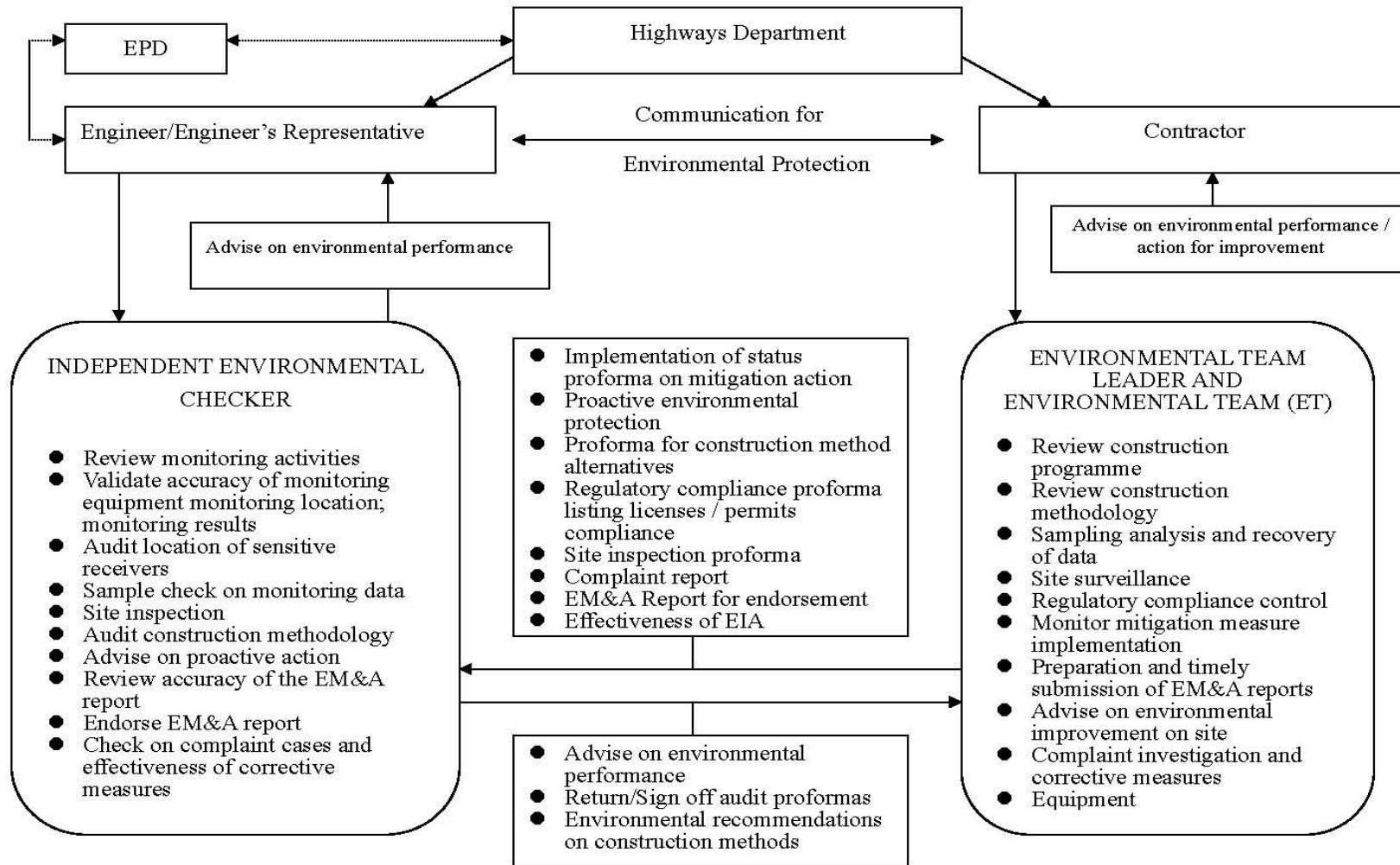

SCALE	N.T.S.	DATE	2007
CHECK	KL	DRAWN	FL
JOB NO.	MA6030	DRAWING No.	2
		Rev	1

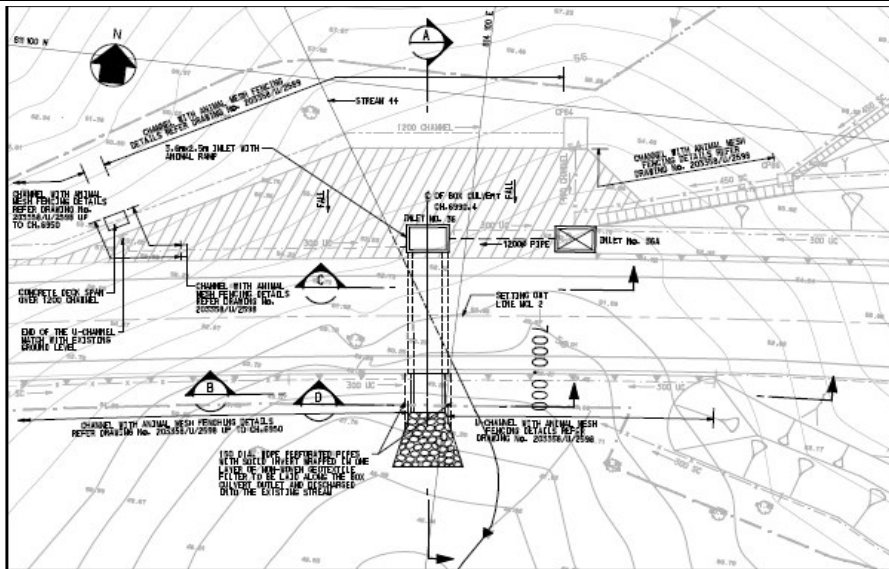

LAYOUT PLAN  
SCALE 1 : 200

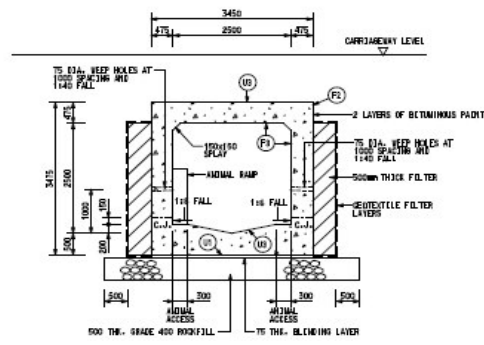
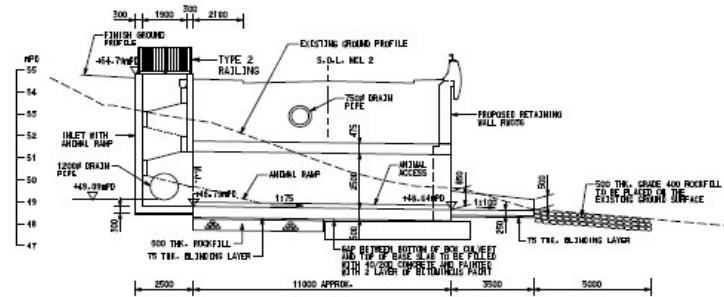

SECTION D  
SCALE 1 : 50

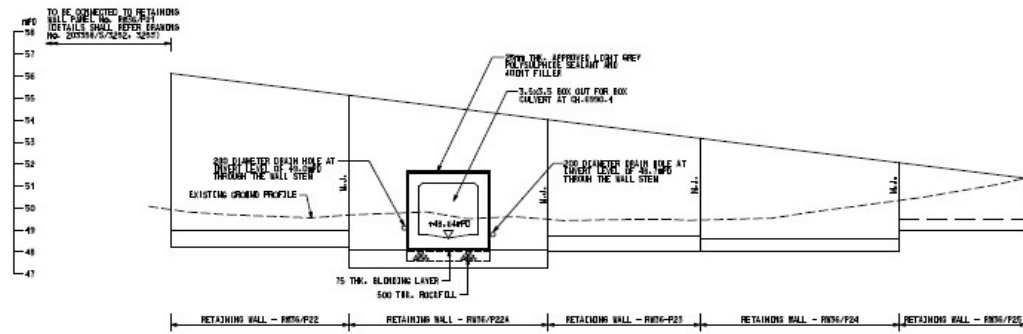

ELEVATION B - B (DEVELOPED)  
SCALE 1 : 100



Contract No. HY/2003/19 Improvement to Tung Chung Road Between Lung Tseng Tau and Cheung Sha

Location of Wildlife Tunnels and Wildlife Ramps (A)

SCALE	AS SHOWN	DATE	24-Nov-09
CHECK BY	WHC	DRAWN BY	GYZ
PROJECT NO.	MA6030	FIGURE NO.	3a







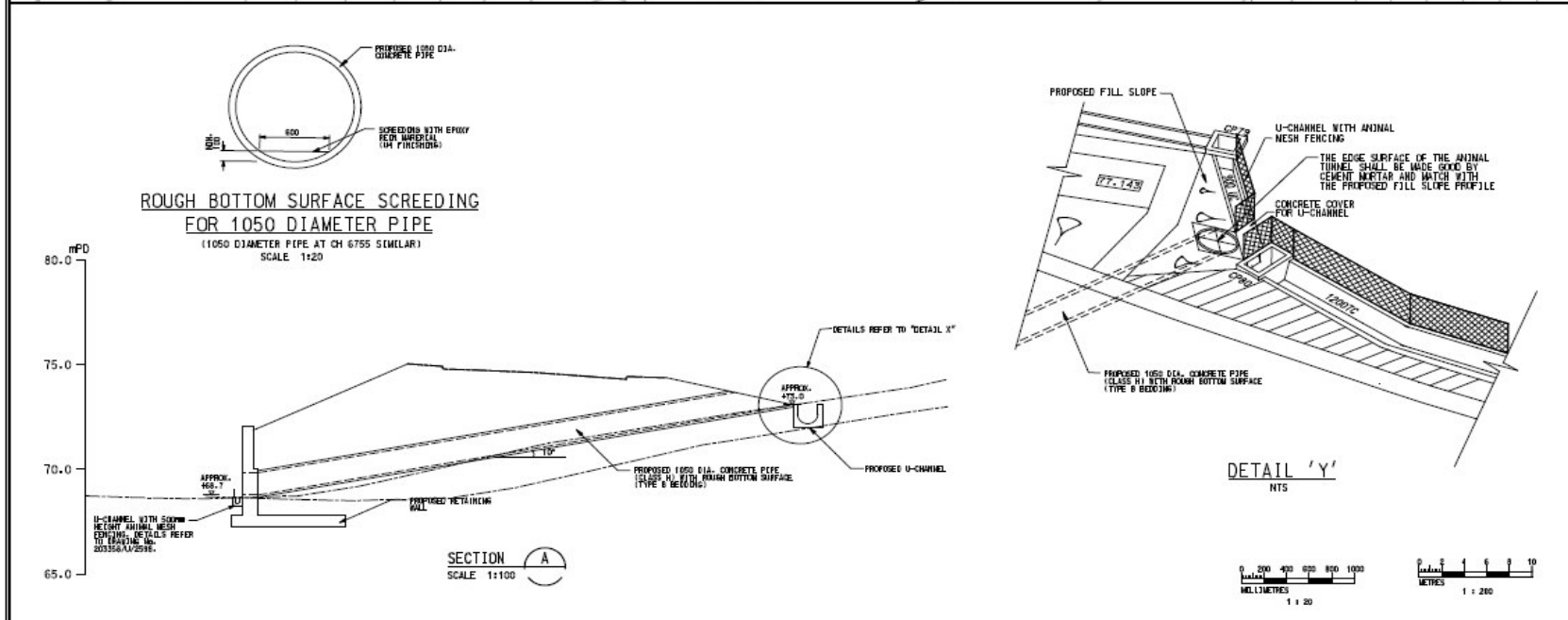
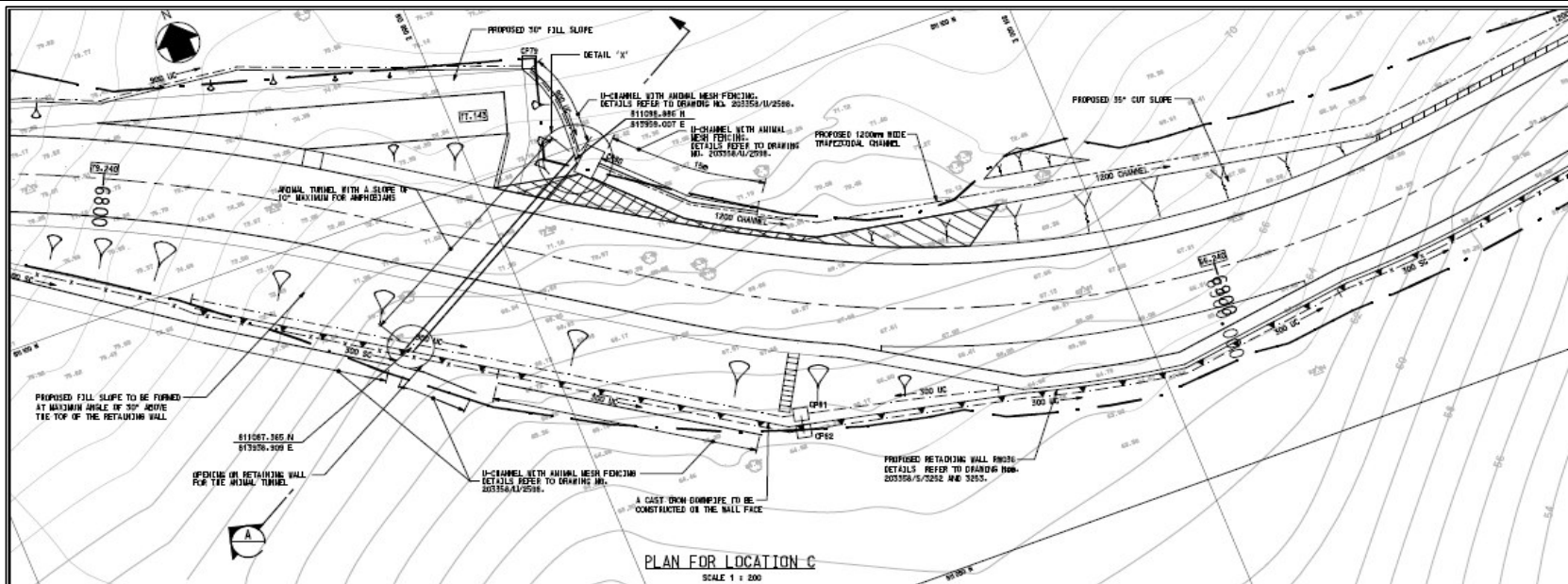

SCALE	AS SHOWN	DATE	24-Nov-09
CHECK BY	WHC	DRAWN BY	GYZ
PROJECT NO.	MA6030	FIGURE NO.	3c

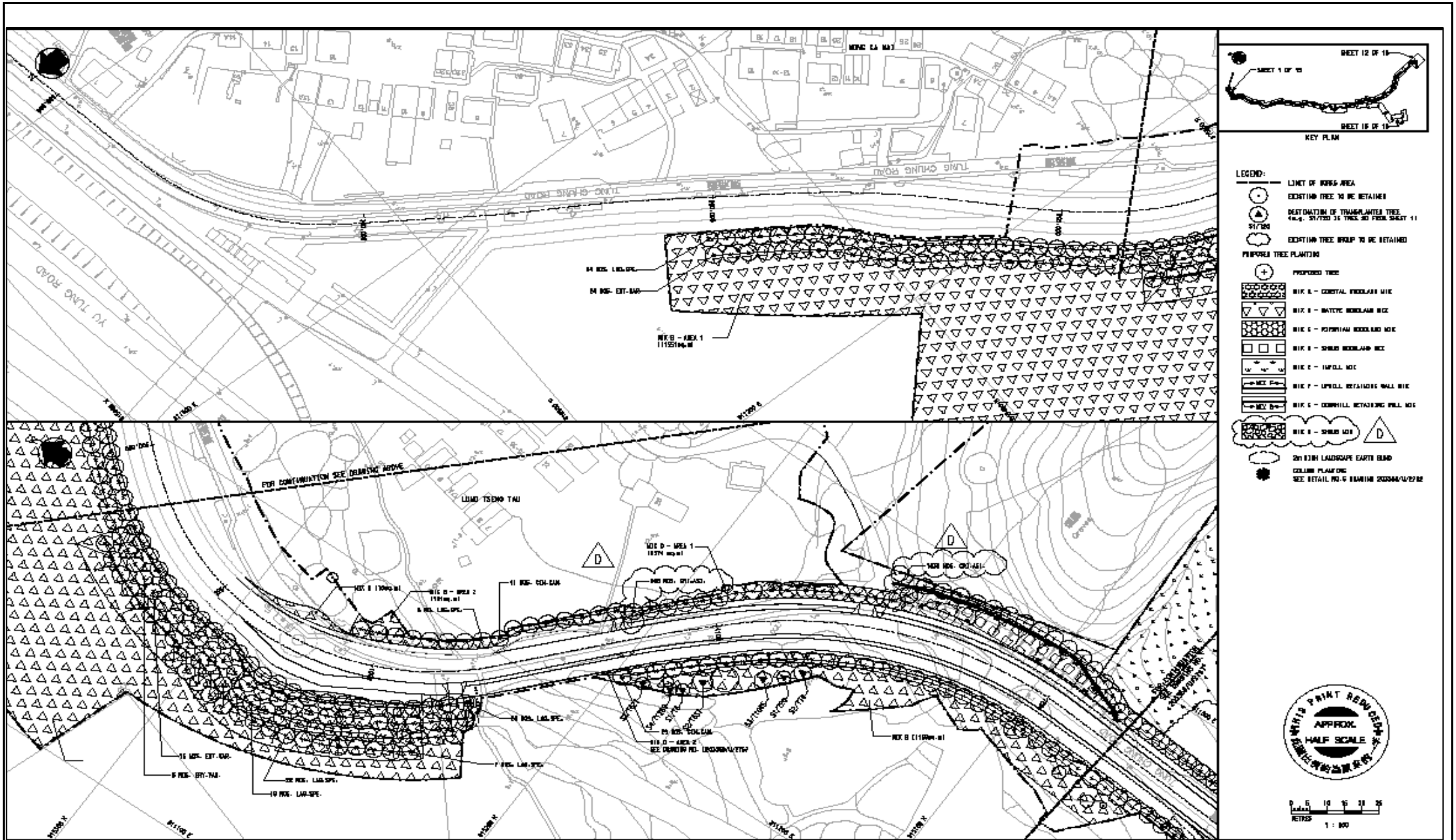

SCALE	AS SHOWN	DATE	24-Nov-09
CHECK BY	LS	DRAWN BY	CMH
PROJECT NO.	MA6030	FIGURE NO.	4



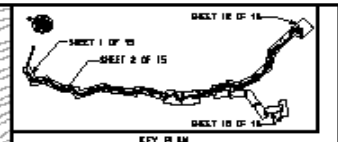
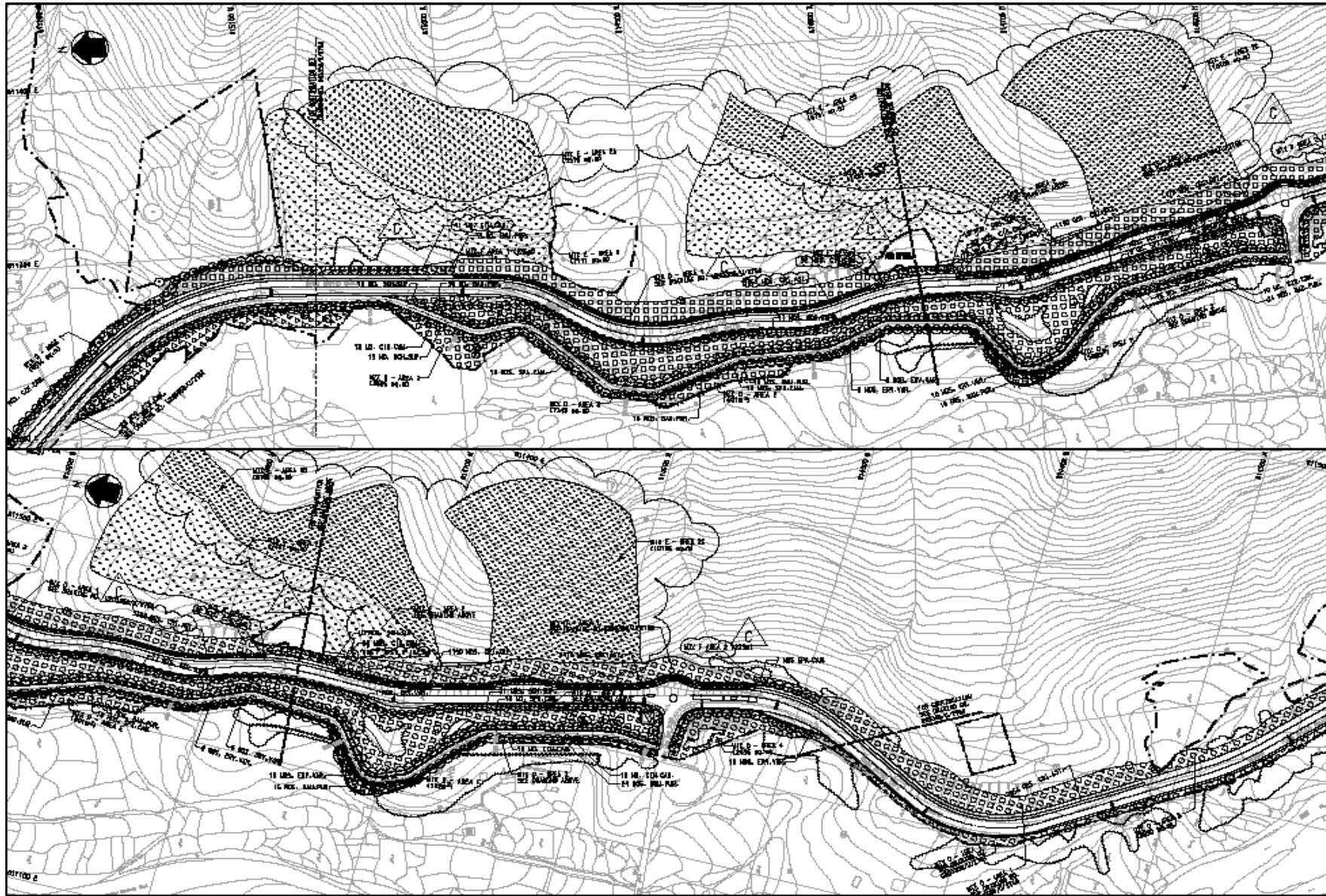

- LEGEND:**
- LOOT OF BIRD'S AREA
  - EXISTING TREE TO BE RETAINED
  - IDENTIFICATION OF TRANSPLANTED TREE 10-15/100'S OF TREE ED FROM SHEET 17
  - EXISTING TREE WOUND TO BE RETAINED
  - PROPOSED TREE PLANTING
  - PROPOSED TREE:
    - MIX A - COASTAL WOODLAND MIX
    - MIX B - PLANTING WOODLAND MIX
    - MIX C - PLANTING WOODLAND MIX
    - MIX D - OPEN WOODLAND MIX
    - MIX E - OPEN MIX
    - MIX F - UPHILL PLANTING MIX
    - MIX G - COASTAL PLANTING MIX
  - 2m HIGH LANDSCAPE BATH BAND
  - SHRUB PLANTING
  - SEE DETAIL, S&B CREATING CHECKING/NOTES



SCALE	AS SHOWN	DATE	24-Nov-09
CHECK BY	LS	DRAWN BY	CMH
PROJECT NO.	MA6030	FIGURE NO.	4



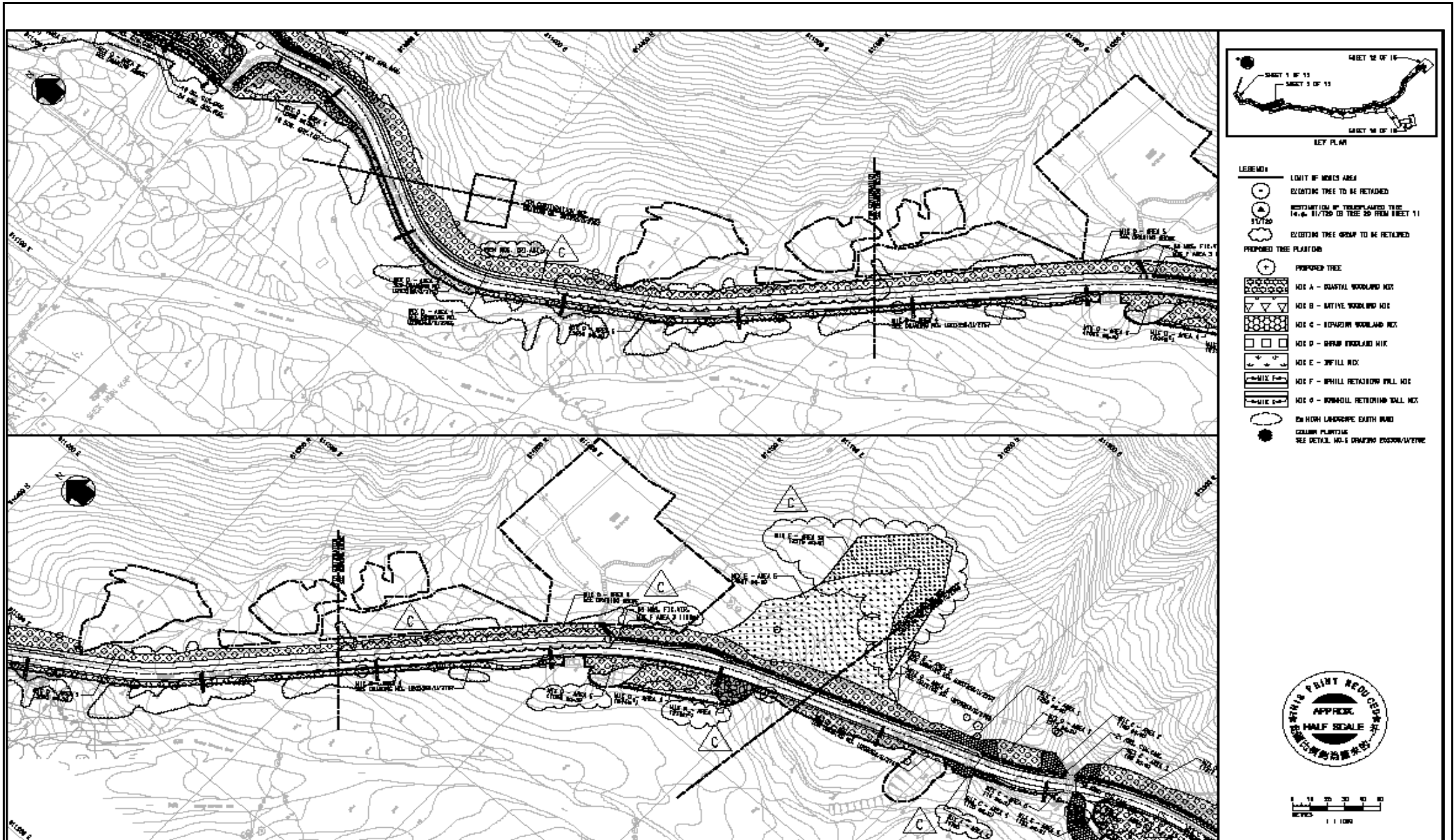

SCALE	AS SHOWN	DATE	24-Nov-09
CHECK BY	LS	DRAWN BY	CMH
PROJECT NO.	MA6030	FIGURE NO.	4

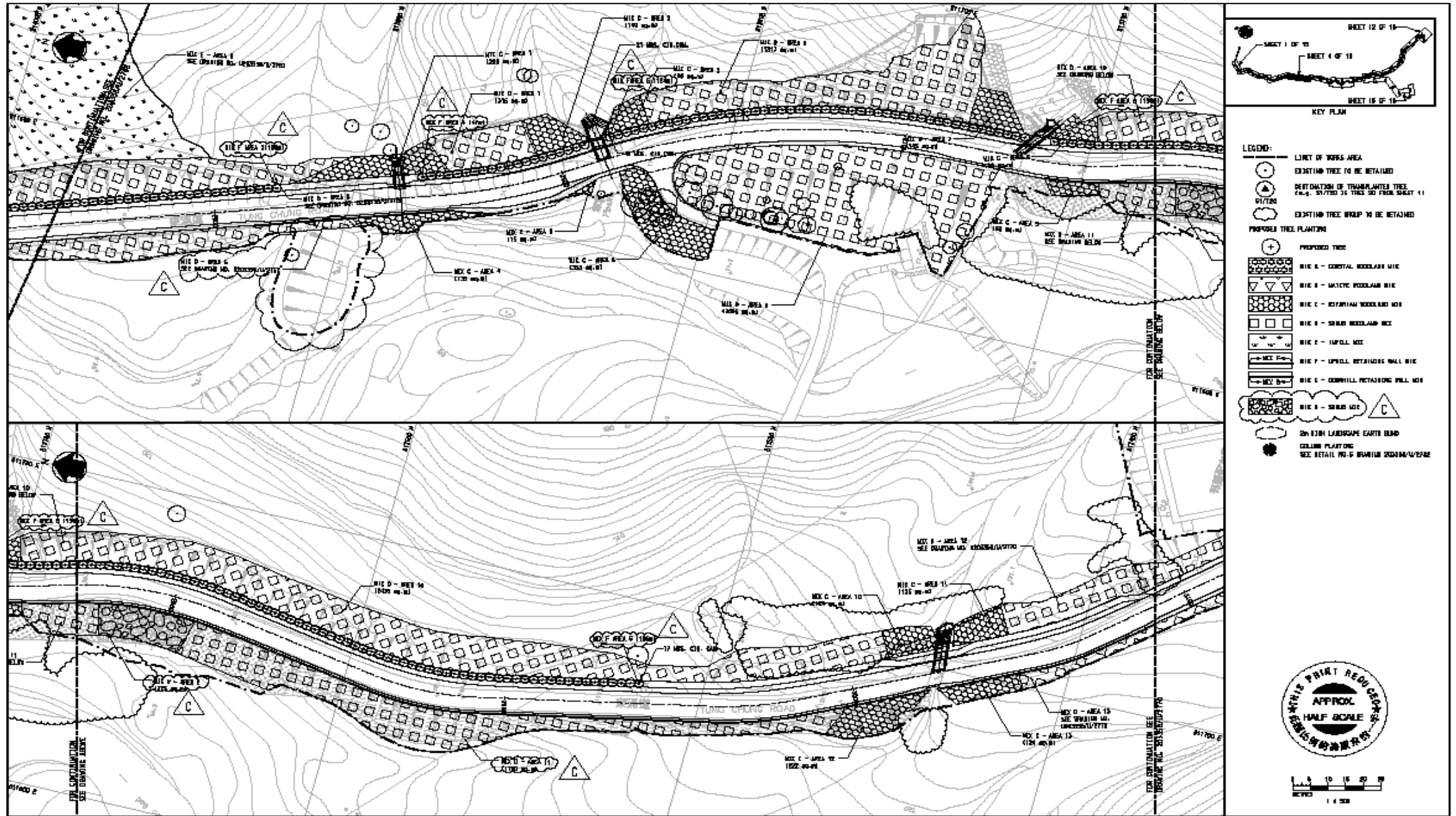





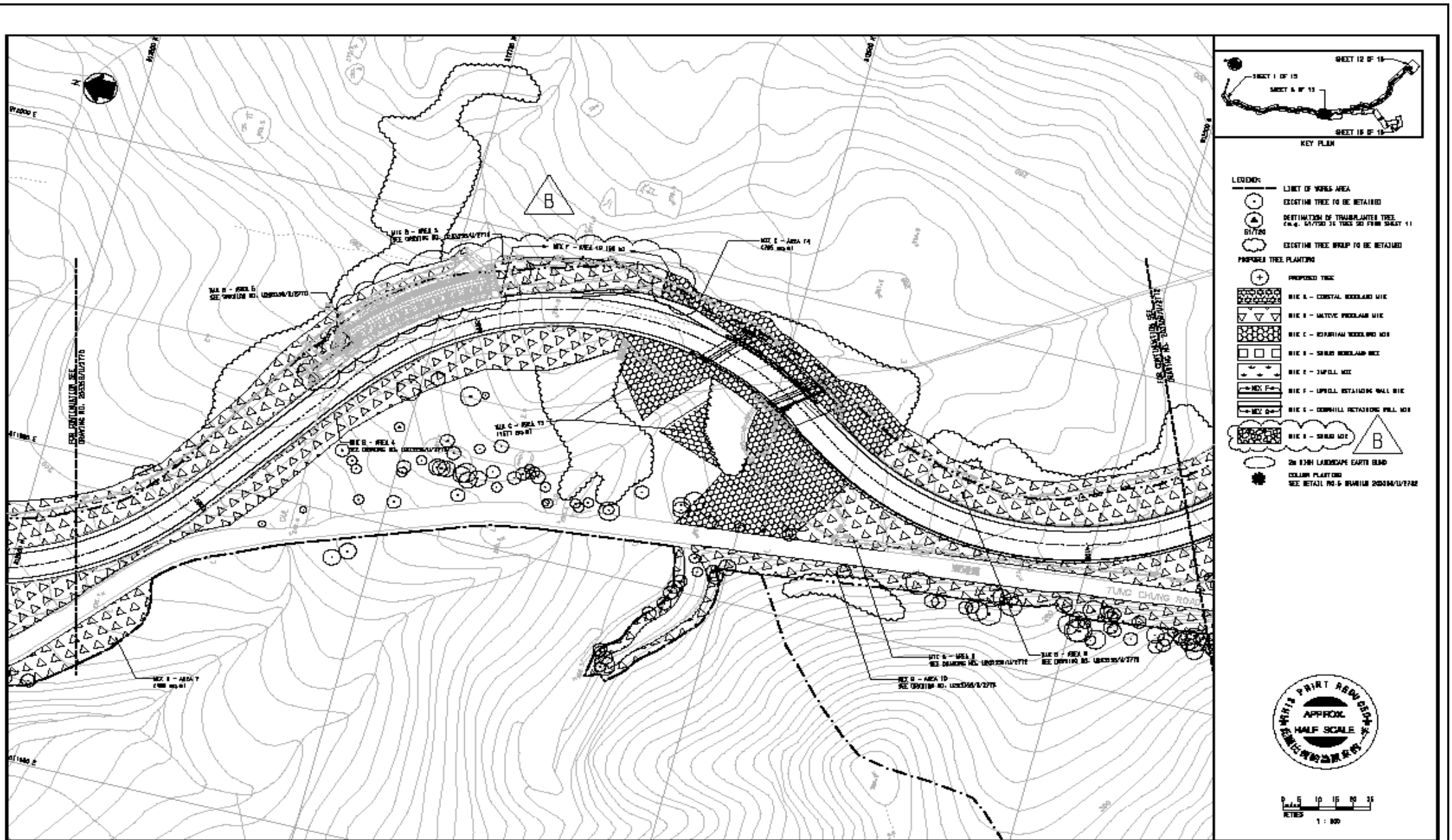

**Contract No. HY/2003/19 Improvement to Tung Chung Road Between Lung Tseng  
Tau and Cheung Sha**

**Landscape Softwork Plan - Sheet 6 of 15**

<b>SCALE</b>	AS SHOWN	<b>DATE</b>	24-Nov-09
<b>CHECK BY</b>	LS	<b>DRAWN BY</b>	CMH
<b>PROJECT NO.</b>	MA6030	<b>FIGURE NO.</b>	4



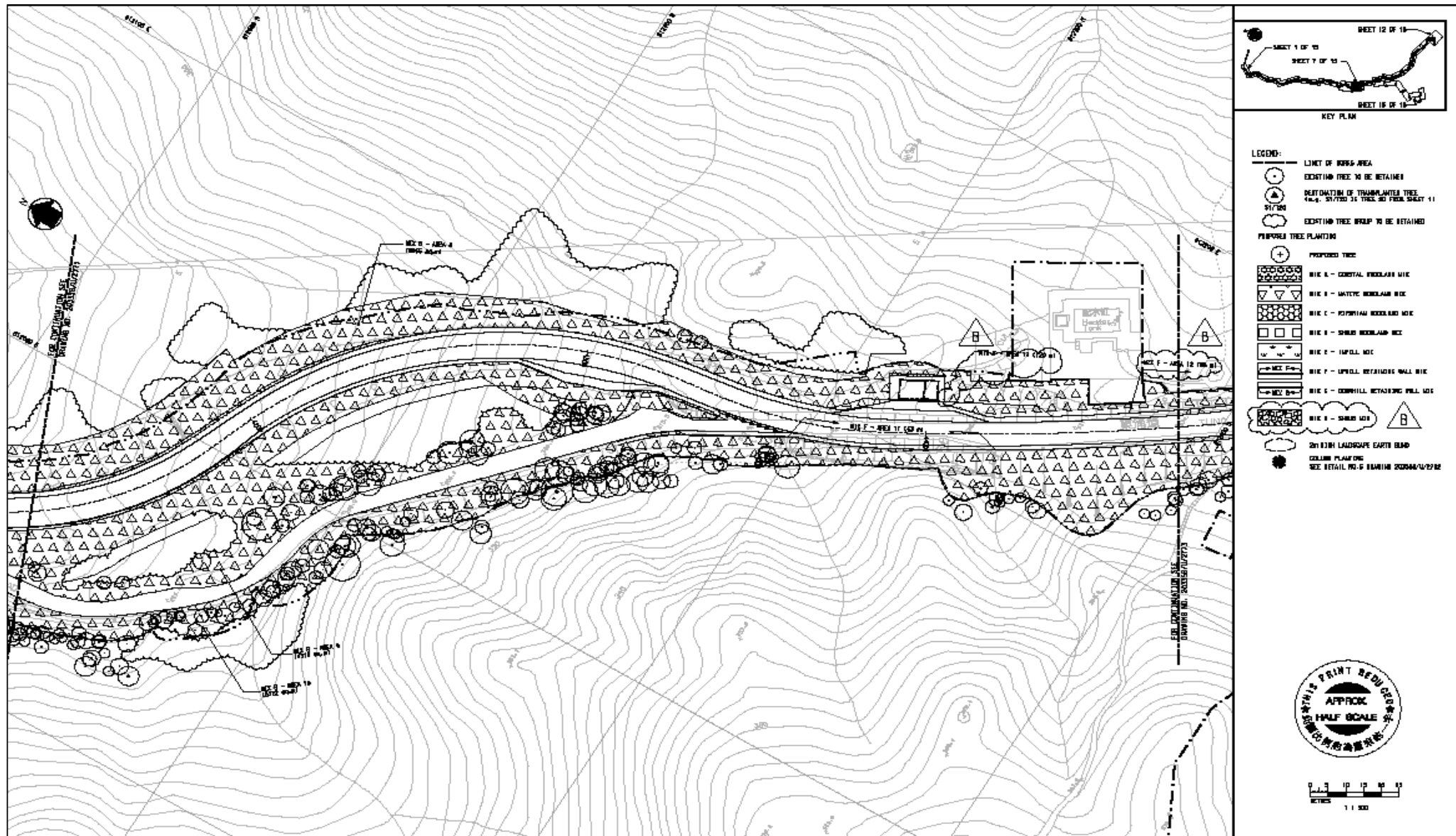

SCALE	AS SHOWN	DATE	24-Nov-09
CHECK BY	LS	DRAWN BY	CMH
PROJECT NO.	MA6030	FIGURE NO.	4



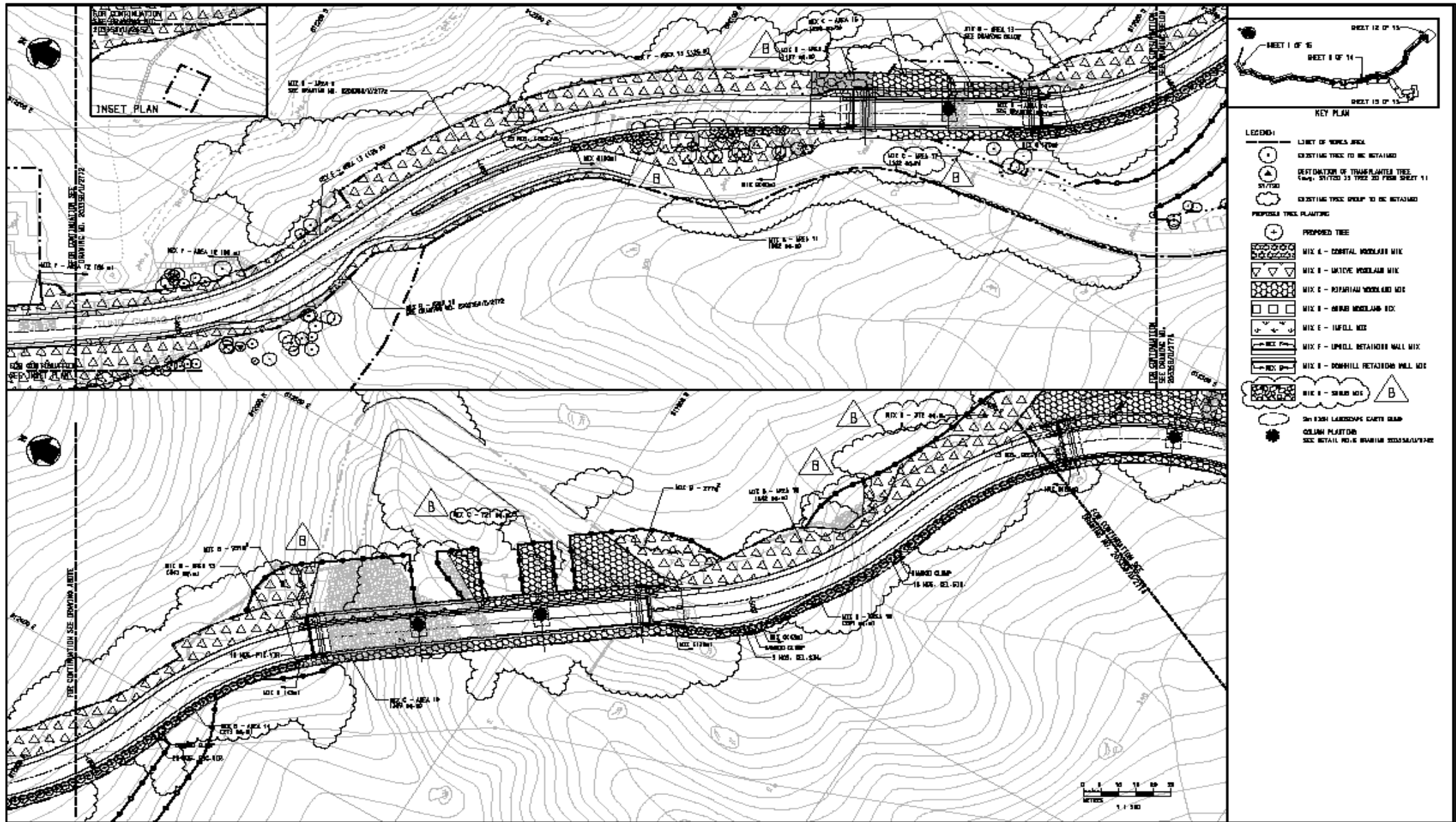

SCALE	AS SHOWN	DATE	24-Nov-09
CHECK BY	LS	DRAWN BY	CMH
PROJECT NO.	MA6030	FIGURE NO.	4

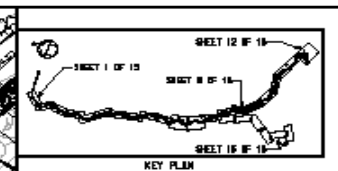
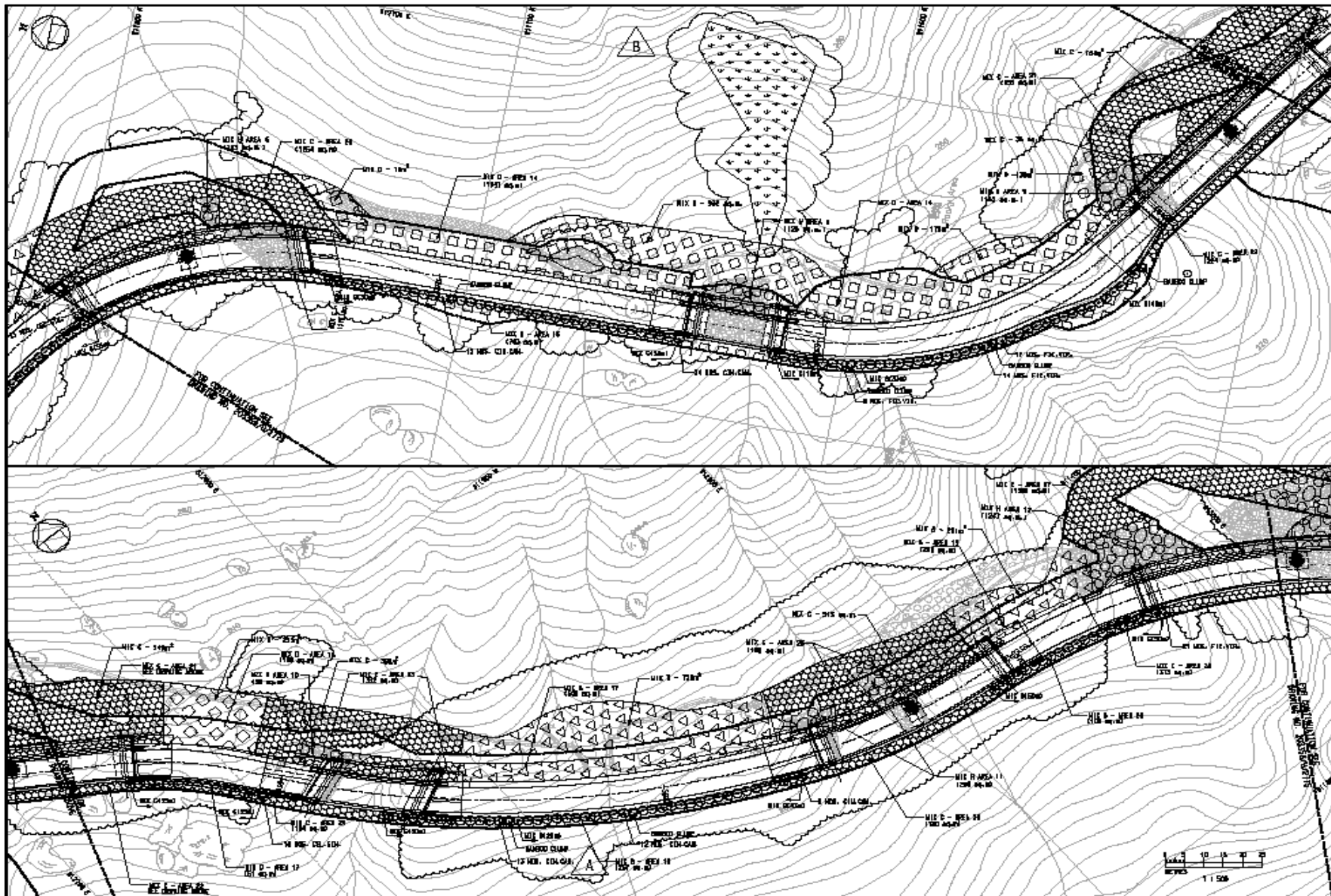

- LEGEND:-**
- LINE OF WORKS AREA
  - EXISTING TREE TO BE RETAINED
  - DESTINATION OF TRANSPLANTED TREE (e.g. 51720 34 TREE 30 FROM SHEET 11)
  - EXISTING TREE GROUP TO BE RETAINED
  - PROPOSED TREE PLANTING
  - MIX A - CORNICE BORDERSIDE MIX
  - MIX B - IMPACTE BORDERSIDE MIX
  - MIX C - SCULPTURAL BORDERSIDE MIX
  - MIX D - SHARED BORDERSIDE MIX
  - MIX E - SWALL MIX
  - MIX F - UPSLOPE RETAINING WALL MIX
  - MIX G - CORNHILL RETAINING WALL MIX
  - MIX H - SHARED MIX
  - ON EXIST LANDSCAPE EARTH BUMP
  - COLUMN PLANTING (SEE DETAIL PG. 6 IN PLAN 2008/04/19/20)



**Contract No. HY/2003/19 Improvement to Tung Chung Road Between Lung Tseng  
Tau and Cheung Sha**

**Landscape Softwork Plan - Sheet 9 of 15**

SCALE	AS SHOWN	DATE	24-Nov-09
CHECK BY	LS	DRAWN BY	CMH
PROJECT NO.	MA6030	FIGURE NO.	4



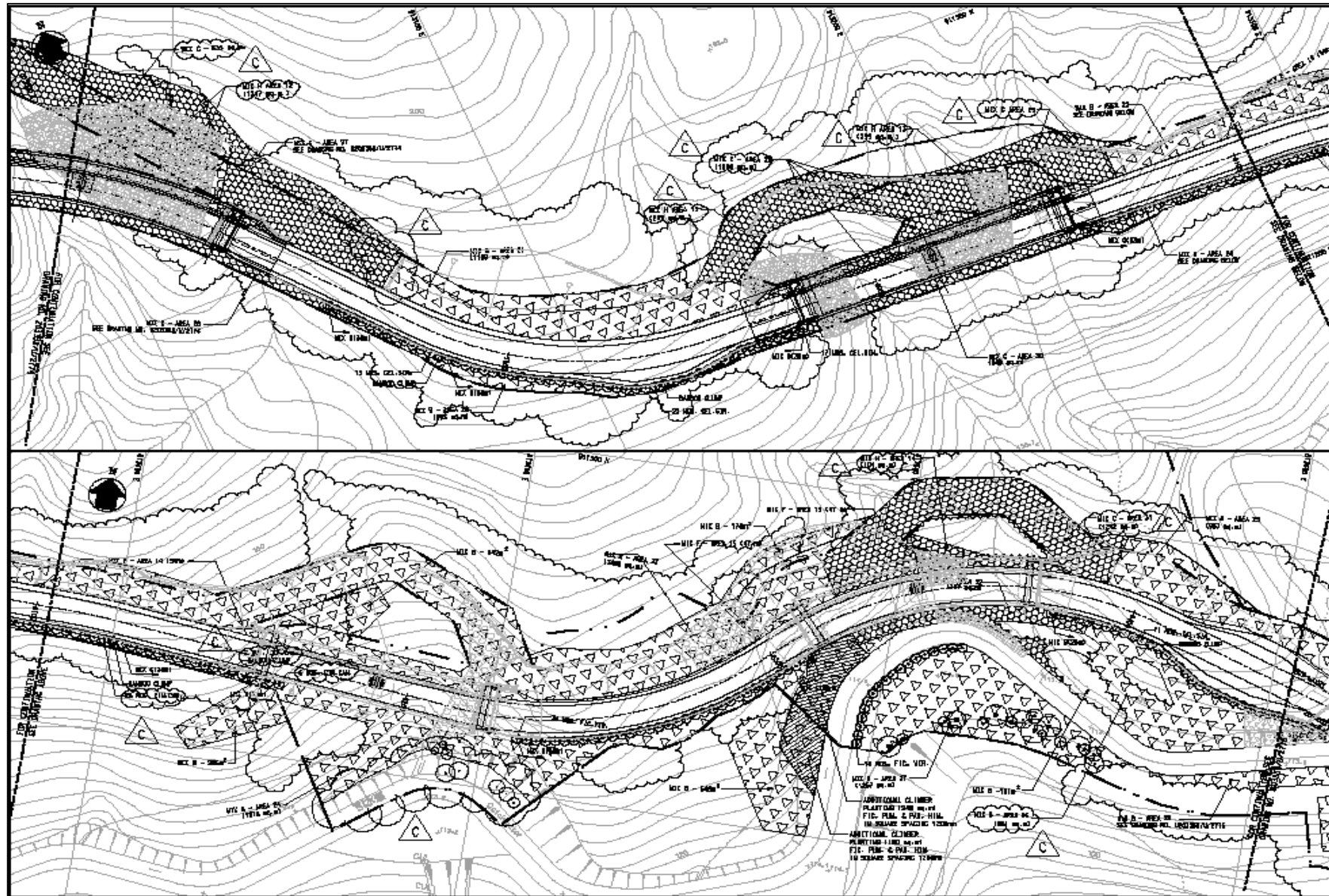

SHEET 10 OF 15

KEY PLAN

**LEGEND:**

- LIMIT OF WORKS AREA
- EXISTING TREE TO BE RETAINED
- DESTINATION OF TRANSPLANTED TREE (e.g., 30/120 IS TREE 30 FROM SHEET 11)
- EXISTING TREE GROUP TO BE RETAINED
- PROPOSED TREE PLANTING
- PROPOSED TREE
- ▨ MIE A - COASTAL WOODLAND MIE
- ▨ MIE B - MARITIME WOODLAND MIE
- ▨ MIE C - SUBURBAN WOODLAND MIE
- ▨ MIE D - SEMI WOODLAND MIE
- ▨ MIE E - JAPANESE MIE
- ▨ MIE F - URBAN RETAINING WALL MIE
- ▨ MIE G - DOWNHILL PESTICIDE MIE
- ▨ MIE H - SEMI MIE
- 20-30% LANDSCAPE EARTH BUMP
- COLLUM PLANTING
- SEE DETAIL P1-6 BEARING 20000/1/2/2



**Contract No. HY/2003/19 Improvement to Tung Chung Road Between Lung Tseng  
 Tau and Cheung Sha**  
**Landscape Softwork Plan - Sheet 10 of 15**

SCALE	AS SHOWN	DATE	24-Nov-09
CHECK BY	LS	DRAWN BY	CMH
PROJECT NO.	MA6030	FIGURE NO.	4

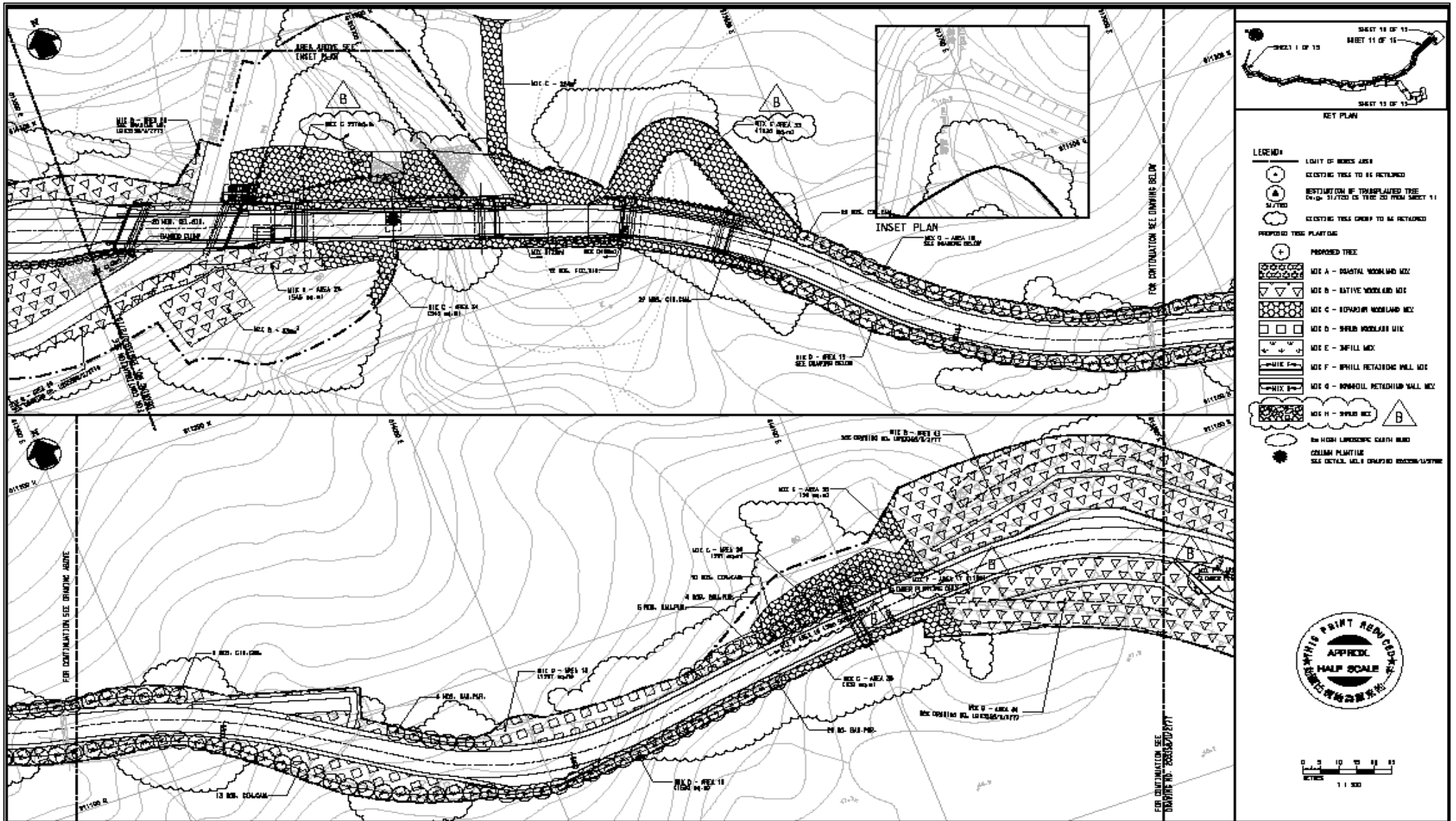

SCALE	AS SHOWN	DATE	24-Nov-09
CHECK BY	LS	DRAWN BY	CMH
PROJECT NO.	MA6030	FIGURE NO.	4



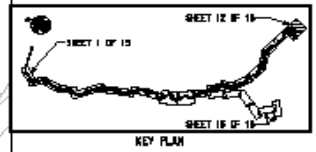
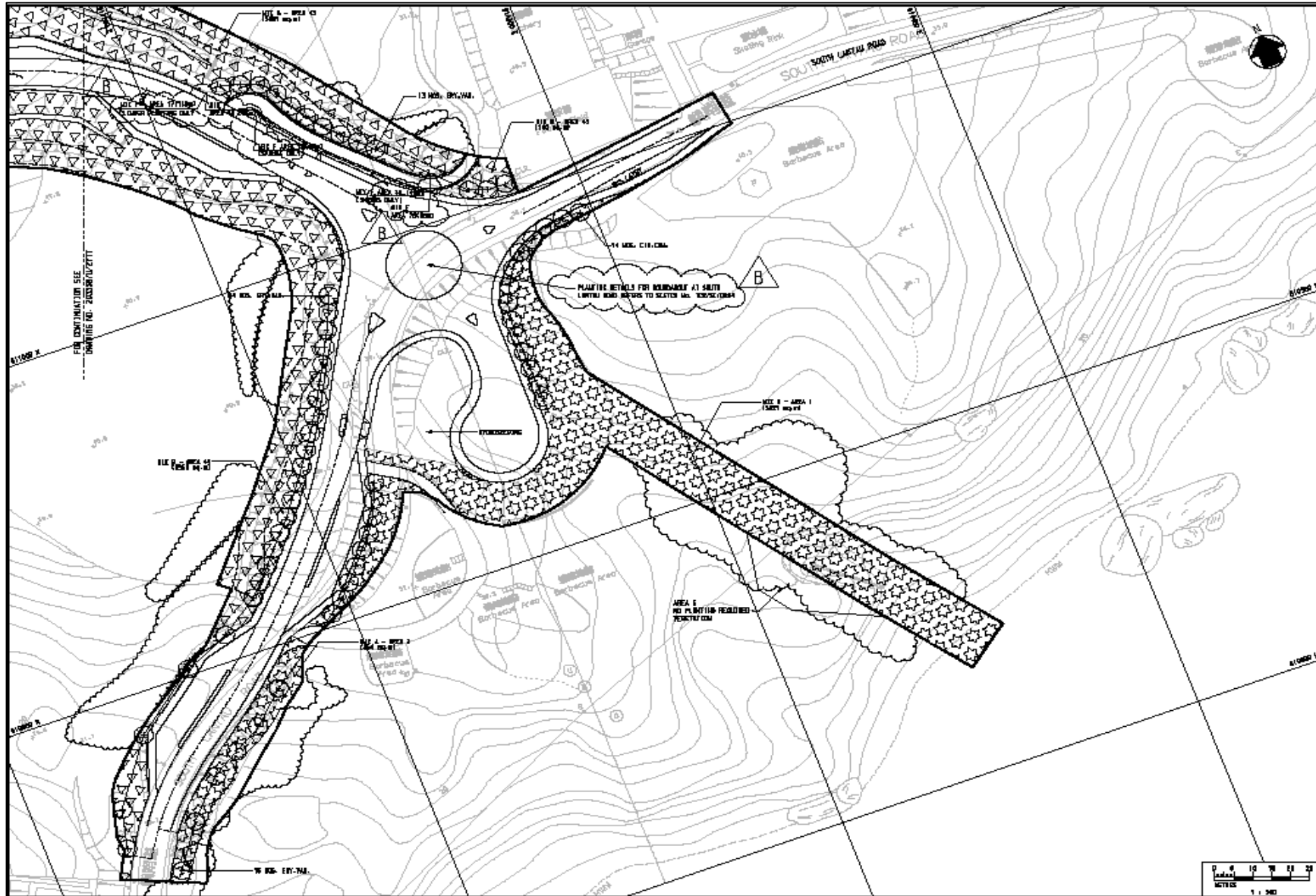

- LEGEND:**
- LINE OF WORKS AREA
  - EXISTING TREE TO BE RETAINED
  - DESTINATION OF TRANSPLANTED TREE (e.g. 50/700 36 TREE 501 FROM SHEET 11)
  - EXISTING TREE GROUP TO BE RETAINED
  - PROPOSED TREE PLANTING
  - PROPOSED TREE
  - ▨ BIE 6 - CENTRAL BEECHLAND MIX
  - ▨ BIE 8 - ARTISTIC BEECHLAND MIX
  - ▨ BIE 9 - BERRYHAM BEECHLAND MIX
  - ▨ BIE 8 - SERRIS BEECHLAND MIX
  - ▨ BIE 2 - SPILL MIX
  - ▨ BIE 7 - UPWELL DETAINING WALL MIX
  - ▨ BIE 5 - BERRYHAM PENTAGON WALL MIX
  - ▨ BIE 8 - SERRIS MIX
  - 200 HIGH LANDSCAPE EARTH BUMP

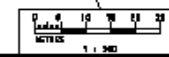

**Contract No. HY/2003/19 Improvement to Tung Chung Road Between Lung Tseng Tau and Cheung Sha**

**Landscape Softwork Plan - Sheet 12 of 15**

SCALE	AS SHOWN	DATE	24-Nov-09
CHECK BY	LS	DRAWN BY	CMH
PROJECT NO.	MA6030	FIGURE NO.	4

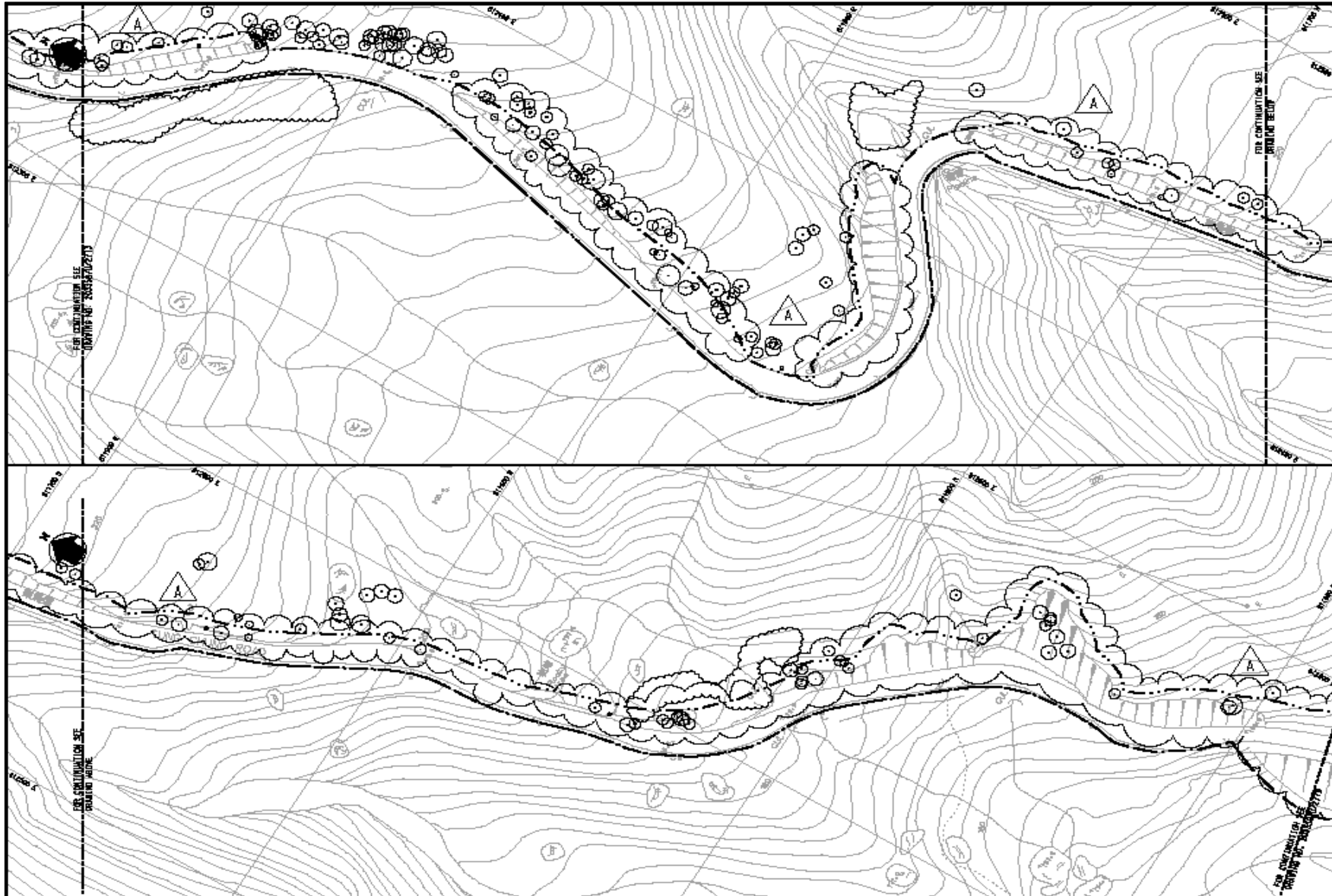

SHEET 12 OF 15  
SHEET 12 OF 14  
SHEET 13 OF 15

KEY PLAN

**LEGEND:**

- LIMIT OF WORKS AREA
- EXISTING TREE TO BE RETAINED
- △ DESTINATION OF TRANSPLANTED TREE (e.g. 51/200 TO TREE 501 FROM SHEET 11)
- ☁ EXISTING TREE GROUP TO BE RETAINED
- ☁ PROPOSED TREE PLANTING
- ⊕ PROPOSED TREE
- ▨ BIK 6 - CENTRAL BUCKLEBARK BIK
- ▨ BIK 8 - MATEIC PROCKLAW BIK
- ▨ BIK 5 - SPARTAN BUCKLEBARK BIK
- ▨ BIK 9 - SIBIR BUCKLEBARK BIK
- ▨ BIK 2 - SUFFOLK BIK
- ▨ BIK 7 - SUFFOLK RETAINING WALL BIK
- ▨ BIK 4 - DOWNHILL RETAINING WALL BIK
- ▨ BIK 3 - SIBIR BIK
- △ ON SLOPE LANDSCAPE EARTH LEAP
- COLLUM PLANTING (SEE METAL PRO-5 NUMBER 2208/4/17/2)

1 : 400

SCALE	AS SHOWN	DATE	24-Nov-09
CHECK BY	LS	DRAWN BY	CMH
PROJECT NO.	MA6030	FIGURE NO.	4

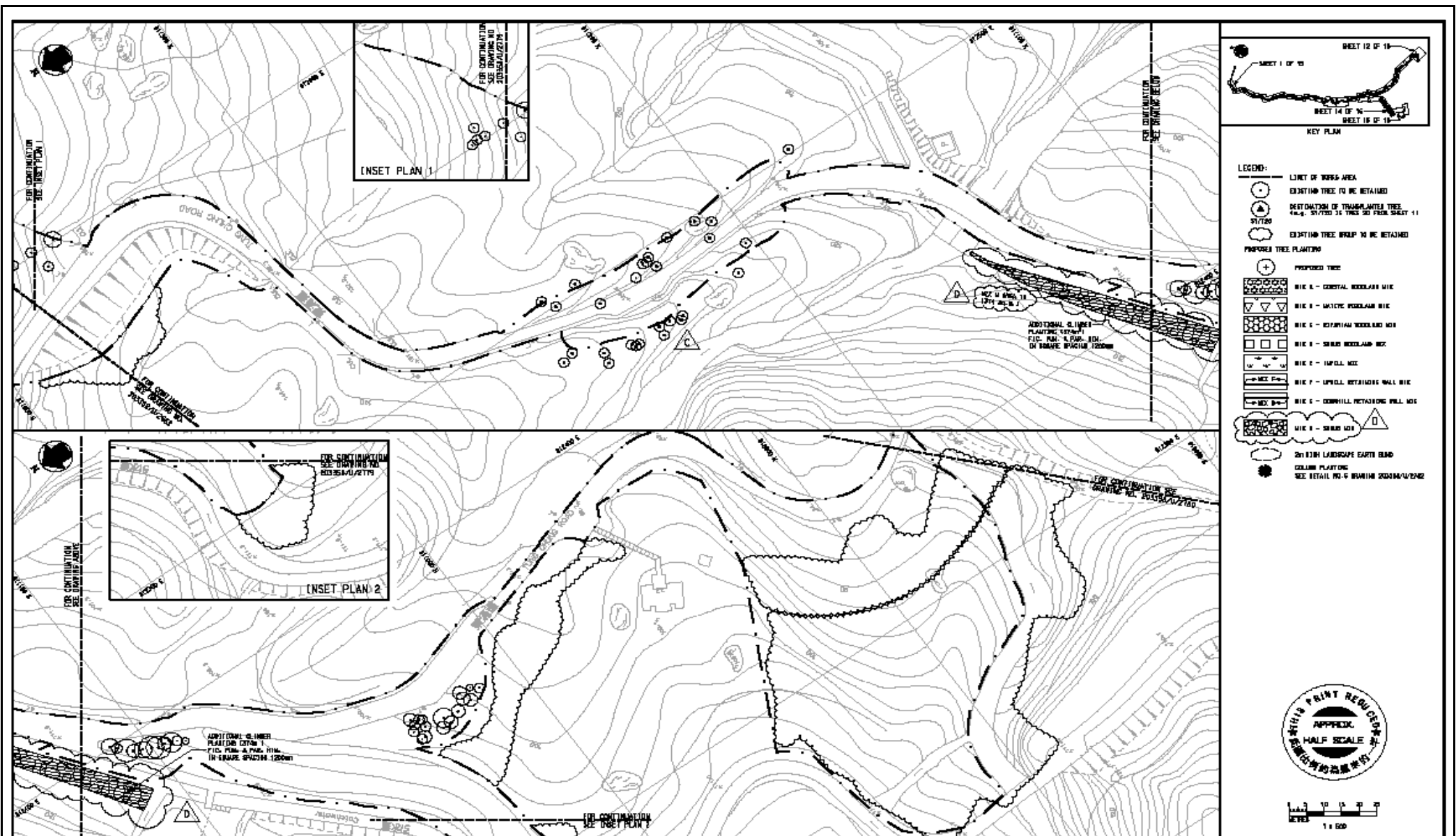

SCALE	AS SHOWN	DATE	24-Nov-09
CHECK BY	LS	DRAWN BY	CMH
PROJECT NO.	MA6030	FIGURE NO.	4





KEY PLAN

**LEGEND:**

- LIMIT OF WORK AREA
- EXISTING TREE TO BE RETAINED
- DESTINATION OF TRANSPLANTED TREE (10-D SYMBOL IS TREE 11 FROM SHEET 1)
- EXISTING TREE GROUP TO BE RETAINED
- PROPOSED TREE PLANTING
- PROPOSED TREE
- ▨ MIX A - COASTAL WOODLAND MIX
- ▨ MIX B - NATIVE WOODLAND MIX
- ▨ MIX C - RIPARIAN WOODLAND MIX
- ▨ MIX D - SHrub WOODLAND MIX
- ▨ MIX E - DEFTIL MIX
- ▨ MIX F - UPRILL RETENTION WALL MIX
- ▨ MIX G - CORNROLL RETENTION WALL MIX
- BY HIGH LANDSCAPE EARTH BARR
- SOLIDUM PLANTING
- MIX G - 10.0 M PROPOSED WOODLAND MIX

1 : 500

SCALE	AS SHOWN	DATE	24-Nov-09
CHECK BY	LS	DRAWN BY	CMH
PROJECT NO.	MA6030	FIGURE NO.	4



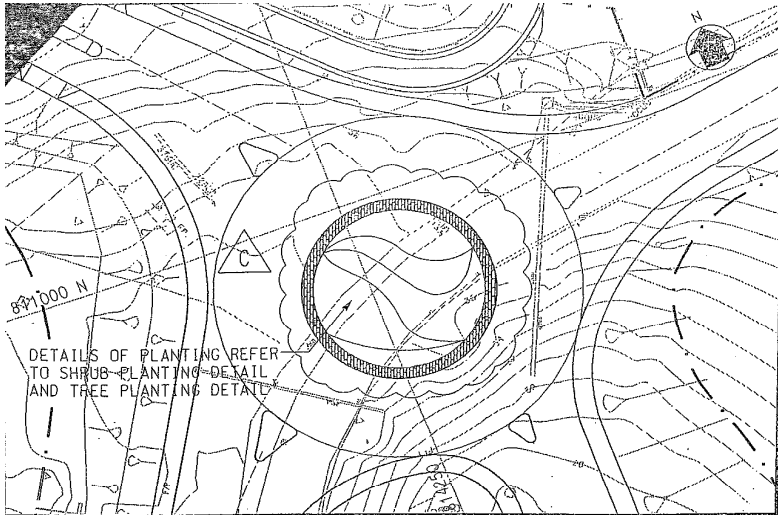

**PLAN**  
SCALE 1 : 500

**SHRUB PLANTING**

Code	Shrub Species	Size	Spacing (mm)	Quantity
rho pul	Rhododendron pulchrum	Medium Shrub	400	509
ixo str	Ixora stricta	Medium Shrub	400	467
ixo coc	Ixora coccinea	Medium Shrub	400	775

**TREE PLANTING**

Code	Roadside Trees	Size	Location	Quantity
LAG_SPE	Lagerstroemia speciosa	Heavy Standard	As Shown	6

**PLANTING SCHEDULE FOR ROUNDABOUT AT SOUTH LANTAU ROAD**

NOTE :  
QUANTITY FOR SHRUBS AND GROUNDCOVERS ARE FOR REFERENCE ONLY. ACTUAL QUANTITY REQUIREMENT SHOULD BE DETERMINED BASED ON SITE CONDITION COUPLED WITH PLANT SPACING SPECIFICATION IN ORDER TO COVER ALL THE BARED SOIL.

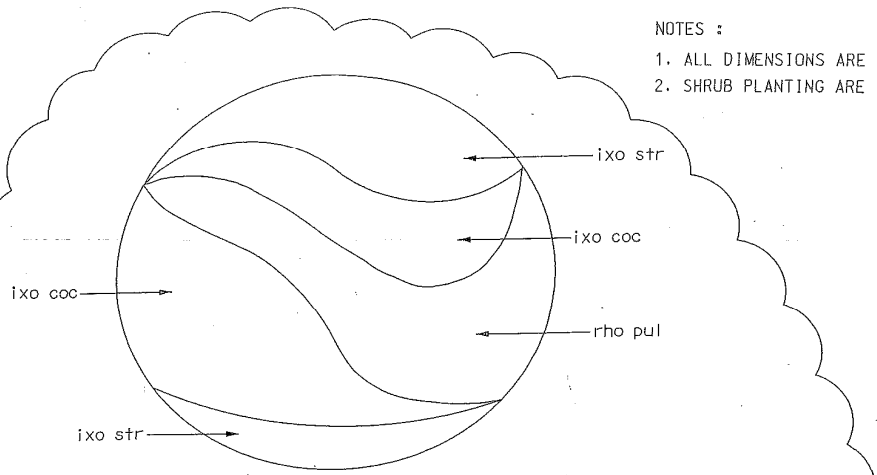

**SHRUB PLANTING DETAIL**  
SCALE 1 : 200

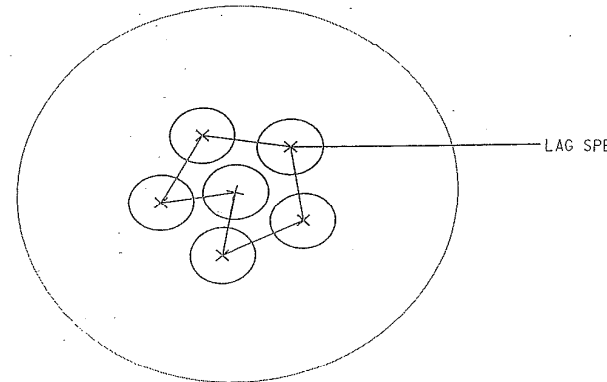

**TREE PLANTING DETAIL**  
SCALE 1 : 200

- NOTES :
1. ALL DIMENSIONS ARE IN MILLIMETRES.
  2. SHRUB PLANTING ARE IN TRIANGULAR PATT

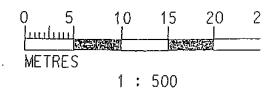
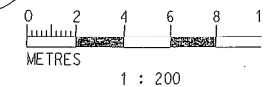

SCALE	AS SHOWN	DATE	24-Nov-09
CHECK BY	LS	DRAWN BY	CMH
PROJECT NO.	MA6030	FIGURE NO.	5

---

---

**APPENDIX A**  
**Photos of Ecological Mitigation Audit**

---

---



**(1) Opening of Wildlife Tunnel (C)**



**(2) Inside Wildlife Tunnel (C)**





**(3) Opening of Wildlife Tunnel with Wildlife Ramp (C)**



**(4) Opening of Wildlife Tunnel with Wildlife Ramp (B)**

	Contract No. HY/2003/19 Improvement to Tung Chung Road Between Lung Tseung Tau and Cheung Sha	SCALE	N.T.S.	DATE	Sep-10
	Photos of Ecological Mitigation Audit	Project No.	MA6030	Appendix	A-2





**(5) Inside Wildlife Tunnel ( C )**



**(6) Opening of the Wildlife Tunnel (C)**





**(7) The sloped Step at Wildlife Ramp (A)**



**(8) Inside the Wildlife Tunnel (A)**



---

---

**APPENDIX B**  
**Article from AFCD**

---

---



---

Ref: AF GR CON 21/2

## Design of Terrestrial Wildlife Crossing System

### 1. Purpose

1.1 The purpose of this Practice Note is to provide technical guidance to relevant government departments, engineers, environmental consultants and other interested persons for design of crossing system for terrestrial wildlife as a mitigation measure for fragmentation by linear transport infrastructures. This Practice Note focuses on the design of Underpass.

1.2 This Practice Note only covers the design elements from ecological perspective while the engineering and cost constraints are project specific. The requirement and practicability of incorporating wildlife crossing system into the engineering design should be determined on a case by case basis by the project proponents.

### 2. Background

2.1 Construction of linear transport infrastructures across important ecological habitats always implies an adverse impact on wildlife. The infrastructures dissect continuous habitats into smaller and isolated patches (**habitat fragmentation**). The higher edge to interior ratios thus increases the level of disturbance effect and reduces the amount of core habitat. Consequently, the habitat quality will be degraded for a much wider zone than the actual physical loss in area that is taken up by of the footprint of the infrastructure (**edge effect**).

2.2 **Barrier effect** occurs when wildlife are unable to cross the road due to physical barriers (e.g. the road surface, ditches, fences and embankments), avoid the area of the roadways (**road avoidance**), or are killed on the road (**roadkills**). Barrier effect, compounds those of habitat fragmentation and isolation, cause impacts on wildlife from individual to population levels (Figure 1).

2.3 Physical barriers may divide wildlife populations into smaller, more isolated units. Individuals in such smaller populations may not be able to interact with populations elsewhere and be more susceptible to genetic deterioration through loss of genetic variation by inbreeding. Over time, they may face local extinction from environmental variability and natural catastrophes. In certain situations, the physical barriers may even block the habitual routes to feeding or breeding grounds of some species (e.g. the frogs cannot reach the ponds where they used to breed), and hence the affected species would not be able to complete their life cycles. However, not all kinds of wildlife are equally susceptible to barrier effect. In general, non-flying terrestrial animals, e.g. mammals, amphibians and reptiles, are more susceptible to barrier effect while birds would have smaller impact because of their relatively high mobility.

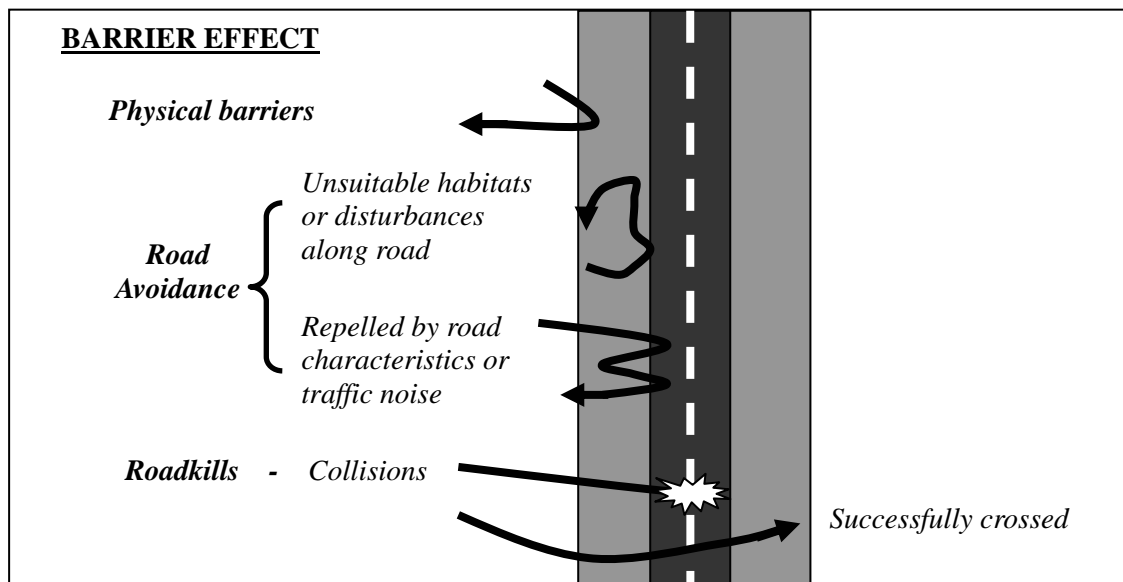

Figure 1 Barrier effect of a road results from a combination of physical hindrance, disturbance, repulsion and mortality etc. (modified after Seiler, 2001).

2.4 The most effective measure to avoid barrier effect and habitat fragmentation of any proposed linear infrastructures is selecting the route of the structure to avoid important ecological habitats (i.e. alternative alignment). Through baseline surveys of the subject area, ecological information of the area such as abundance of wildlife and major wildlife movement corridors should be collected, and hence the locations of potential wildlife-traffic conflict points should be identified.<sup>1</sup> All such locations should be taken into consideration and avoided as far as practicable during the route selection process.

2.5 Should habitat fragmentation be unavoidable and the ecological information reveals that there are potential problems of wildlife-traffic conflict in operation phase (e.g. a high density of wildlife movement in the subject area, and the species involved are susceptible to the barrier effect created), appropriate designs of the infrastructures and mitigation measures should be recommended to minimize the ecological impacts of the development. For instance, measures should be implemented to make the roads more permeable for wildlife by offering safe alternative ways of crossing.

### 3. Wildlife crossings

3.1 Wildlife crossings is the collective term referring to the artificial links constructed above roadways (overpasses) or underneath roadways (underpasses) to facilitate safe passage of wildlife through fragmented habitats, and hence re-establish habitat connectivity across the infrastructure barriers (i.e. de-fragmentation).

3.2 **Overpass** structures, also called ecoducts or green bridges, are usually wider on each end and narrower in the centre. A soil layer is added on the surface of the overpasses to allow growth of herbaceous vegetation, shrubs and even small trees for attracting wildlife. However, overpasses are often large in scale and expensive to construct, and should only be used for important migration corridors between significant habitats.

<sup>1</sup> The Environmental Impact Assessment Ordinance Guidance Notes No.7/2002 on Ecological Baseline Survey for Ecological Assessment and No. 10/2004 on Methodologies for Terrestrial and Freshwater Ecological Baseline Surveys provide the general guidelines for conducting an ecological baseline survey and introduce some methodologies in conducting such surveys respectively.



3.3 **Underpass** structures can be in form of bridge underpasses when roads are above open fields, cross streams or other roads (e.g. viaduct and open-span bridge) and can be used to provide a relatively unconfined passageway for wildlife. Underpass can also be in form of tunnel or box culvert (Figure 2). Tunnels and culverts are usually made of steel or concrete material and are mostly engineered to allow water flow or traffic under road structure. However, specially designed tunnels and culverts could also facilitate wildlife movement and habitat connectivity.

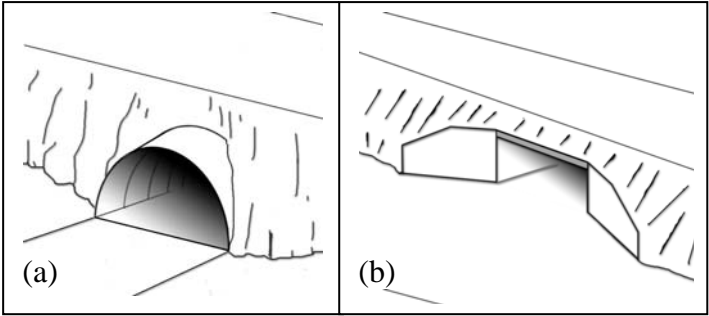

Figure 2. Basic design of common underpasses (a) tunnel and (b) box culvert.

3.4 Modification on the design of tunnels for traffic or pedestrians can also be applied for providing wildlife passage. Tree stumps and other suitable substrates could be placed along one side of the tunnel to promote wildlife usage but suitable screens or partitions should be established between the wildlife passage and the traffic line.

3.5 Using crossing structures to mitigate the negative impacts of roadways or railway on wildlife is a relatively new concept in Hong Kong. There have been a few ecological impact assessments which propose wildlife crossing as mitigation measures to barrier effects. The first purposely constructed wildlife crossing in Hong Kong is a concrete tunnel beneath Route 3 at the Ting Kau end of Tai Lam Tunnel of Route 3. The structure is about 70 m in length and 1.8 m in internal diameter. It aims to facilitate the movement of Masked Palm Civet (*Paguma larvata*) and Red Muntjac (*Muntiacus muntjac*) (Figure 3). However, recent monitoring results demonstrated that the wildlife tunnel was very low in usage which was attributed to the design of the structure (Shek, 2006). A few more local examples are illustrated in section 5.

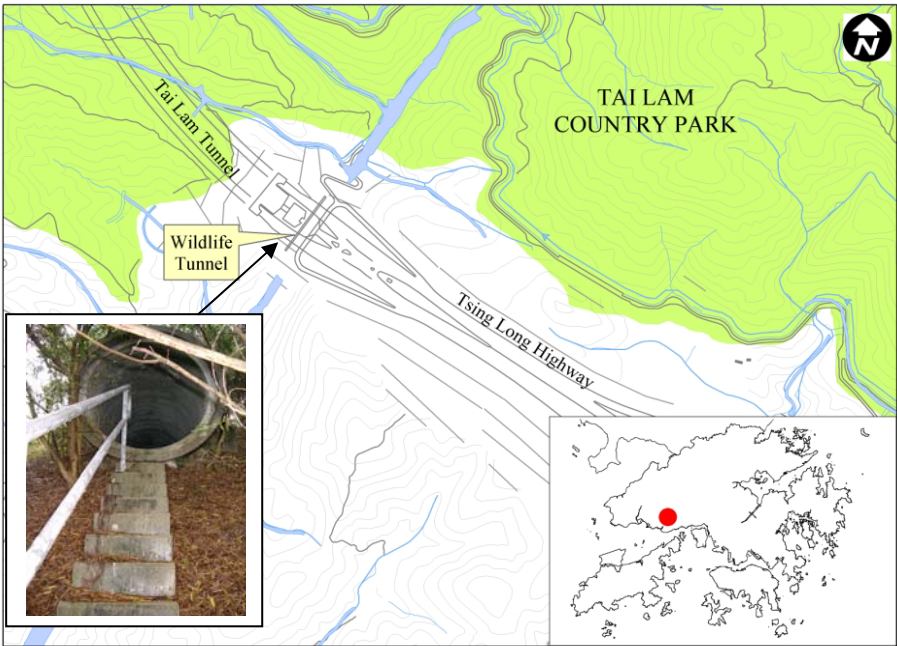

Figure 3. The first purposely constructed wildlife underpass in Hong Kong crossing beneath Route 3.

## **4. Design elements of underpass structures**

4.1 While wildlife underpass can be of many different structures, shapes and sizes, the most fundamental issue in the design depends on the target species to be determined on a case by case basis. It is important to understand the distribution, abundance, ecological and behavioural need of the target species. There are however some basic design elements that make the structures more permeable for all wildlife. The design elements for success include placement, wildlife accessibility, structure design (e.g. size, substrate, vegetative cover, human disturbance, temperature, light and moisture), fencing mechanism, and on-going maintenance and monitoring which are discussed in the following paragraphs.

### ***Placement***

4.2 Proper placement is the key factor of an effective wildlife underpass. The most appropriate location of an underpass should be near the impacted wildlife movement corridor, and the road sections where roadkills are likely. Suitable habitats should be present on both sides of the road in the proximity of the underpass and be protected in the future. Otherwise, the underpass would become unsuitable for wildlife or even a mortality sink.

### ***Accessibility***

4.3 An underpass structure would be of no use if it is inaccessible to the target species. The accessibility of an underpass is subject to various physical factors, such as the steepness of underpass itself or the slope leading to the structure, and the structure entrance height above the ground surface. For instance, a perched pipe or standing water at the entrance of an underpass will render the structure less accessible to many animals. As such, appropriate design around the structure entrances should be incorporated into the structure design to ensure the accessibility.

4.4 Underpasses are more effective in facilitating wildlife passage and preventing road kill when the option of utilizing the underpasses is more appealing to the target species than the option of crossing the roadway. To encourage wildlife to approach an underpass, the area in proximity to the entrance should be unlit and free from human disturbance. Suitable habitat of dense vegetation surrounding and leading up to the underpass entrance can provide smaller animals with protection by concealing them from predators.

### ***Openness ratio***

4.5 Dimension of a wildlife underpass is determined by the road width, the structure type, and the functional groups of target species. Large and medium mammals that use their eyesight to avoid predation usually prefer open vistas, where a relatively large openness ratio of the underpass may be more important than the absolute size.

$$\text{Openness Ratio} = \frac{\text{Cross - sectional area of underpass opening}}{\text{Length of underpass}}$$

4.6 Underpasses may be designed by adjusting the size of the structure proportionally to its length to make the aperture appearance large enough that animals can see the opposite end of an underpass, and hence consider that it is safe to enter. On the contrary, small mammals, amphibians and reptiles generally prefer underpasses with smaller cross-sectional areas.

### ***Substrate and moisture***

4.7 In general, an underpass would look appealing to wildlife if its internal habitat resembles ambient conditions such as substrate, moisture, light, temperature and noise. An effective underpass should maintain habitat continuity by providing, throughout the entire

length of the structure, an appropriate natural substrate that is consistent with the external surroundings on either side of the underpass.

4.8 Some small mammals, amphibians and reptiles use vegetation or topography to hide themselves from predators and the drying heat of the sun. These animals would feel more secure entering an underpass if it provides sufficient cover, which could be created by placement of piles of gravels or vegetative debris such as tree stumps, hollow logs and small bush around the structure and along the edge of its interior walls. These covers could also create a moist environment generally favoured by amphibians and riparian reptiles.

### ***Ledge***

4.9 While moist substrate is important for amphibians and riparian reptiles, standing water within underpasses would deter many animals from entering the structures. As such, underpasses that accommodate amphibians and riparian reptiles should maintain moist substrate but at the same time provide a dry ledge along the entire length of one or both interior walls of the structure (Figure 4). The ledge allows other wildlife to pass through the underpass when it is filled with water. Again, the ledge should be covered with natural substrate and hiding cover consistent with the external surroundings and is wide enough to accommodate the target species.

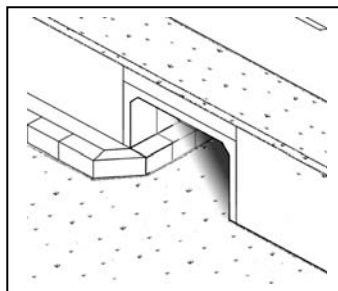

Figure 4. Box culvert with ledge for wildlife passage

### ***Interior walls***

4.10 The interior walls of an underpass could be modified to mimic a natural corridor. For instance, the interior walls of the structure could be painted dark at the bottom but white above to resemble natural conditions. The wall surfaces could be made roughly textured so as to reduce unnatural sounds such as pattering when wildlife moves through the underpass.

### ***Lighting and temperature***

4.11 There have been evidences that artificial light deters animals from utilizing an underpass. Ambient light conditions inside an underpass could be maintained by providing an entrance of larger cross-sectional area (i.e. larger openness ratio) or by incorporating an open-top system at certain portions of the underpass (e.g. light shafts in the central divider as in Figure 5). The open-top system would also allow more air flow within the underpass which could reduce the temperature difference between inside and outside of the structure. Nonetheless, covers such as piles of rocks or vegetative debris which create a darker environment should be placed within the structures if small mammals, amphibians and reptiles are also the target groups.

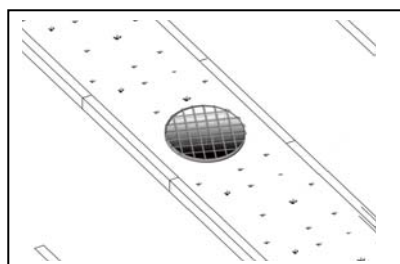

Figure 5. Circular light shaft in the central divider



## 5. Fencing mechanism

5.1 An effective wildlife crossing system should be constituted of properly designed crossing structures as discussed above together with a fencing mechanism. Barrier fence along the roadways in both directions of the crossing structures is a vital feature of a crossing system. It compliments the crossing structures by keeping wildlife off the road to avoid roadkills while guiding them to the crossing structures. In the project “Improvement to Tung Chung Road between Lung Tseng Tau and Cheung Sha” on Lantau Island, a fencing mechanism is introduced to keep small mammals and amphibians, particularly the Romer’s Tree Frogs (*Philautus romeri*), off the road as well as the U-shaped channels while guiding them to the three underpasses constructed to mitigate the barrier effect caused by the road works (Figure 6).

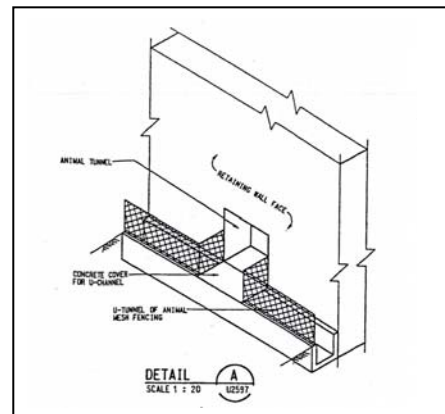

Figure 6. Fencing along the improved Tung Chung Road between Lung Tseng Tau and Cheung Sha, Lantau Island (after Mott Connell, 2003).

### ***Size and material***

5.2 Height, mesh size and material of the barrier fence are the basic but important considerations in designing an effective fencing mechanism. There is no effective standard for its sizing as it varies with the target species. In general, fence height may range from 300 mm for amphibians to 2,000 mm or more for large mammals. Longitudinally, the fencing should extend far enough on both side of an underpass to reduce roadkills and guide the target species towards the underpass.

5.3 Fencing material should be chosen to avoid penetration by the target species. The commonly used materials include chain link, plastic vinyl, concrete, galvanized tin and aluminum flashing. As some animals such as small mammals, amphibians and reptiles may be able to pass through the fence, wire fence of fine mesh size could be applied to the bottom one-third to one half of a large-mesh fence (Figure 7). In the Tung Chung Road improvement project, a very fine aluminum mesh (5x9.5 mm) of 300 mm in height is used to prevent the tiny Romer’s Tree Frog from passing through the fence (Figure 8).

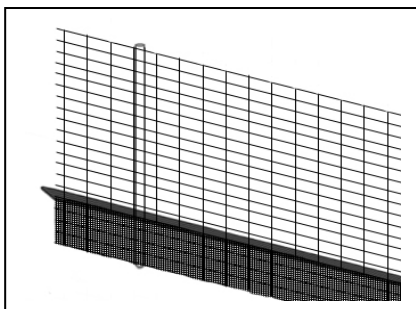

Figure 7. A double fence consisting a high, large-mesh fence and a low, fine-mesh fence. The fine-mesh fence is bent over at the top to stop animals climbing over it.

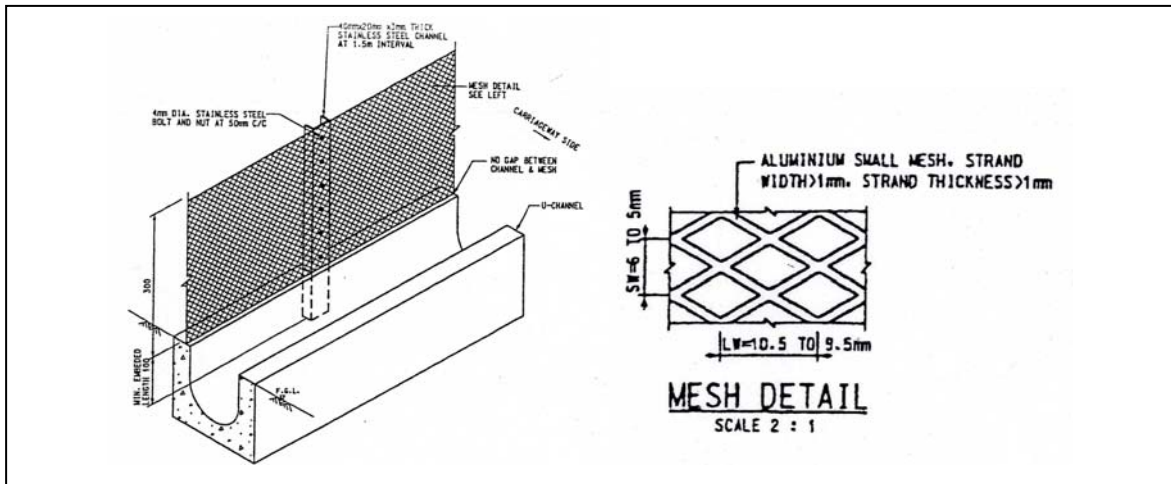

Figure 8. Fencing along the improved Tung Chung Road between Lung Tseng Tau and Cheung Sha, Lantau Island (after Mott Connell, 2003).

5.4 In the project of “Lok Ma Chau Terminus and Associated Works of the Kowloon-Canton Railway (KCR) East Rail Extensions”, a wildlife underpass linking the fishponds on both sides of the railway is proposed to serve as a corridor for Eurasian Otter (*Lutra lutra*) inhabiting in the area. The underpass consists of a tunnel 800mm in diameter suitable for use by Eurasian Otter or similar-sized mammals. A 300mm gently sloping grasscrete ledge connecting the tunnel with the adjacent nullah would provide a wildlife corridor suitable for Eurasian Otter which typically uses the sides of channels as movement corridors. At the center of the tunnel, a drain is provided to prevent water logging which would hinder the use of the underpass by the animals. Chain link fence of large mesh (40 x 40 mm) of 1,125 mm in height and an inclined top is adopted as the fencing mechanism (Figure 9).

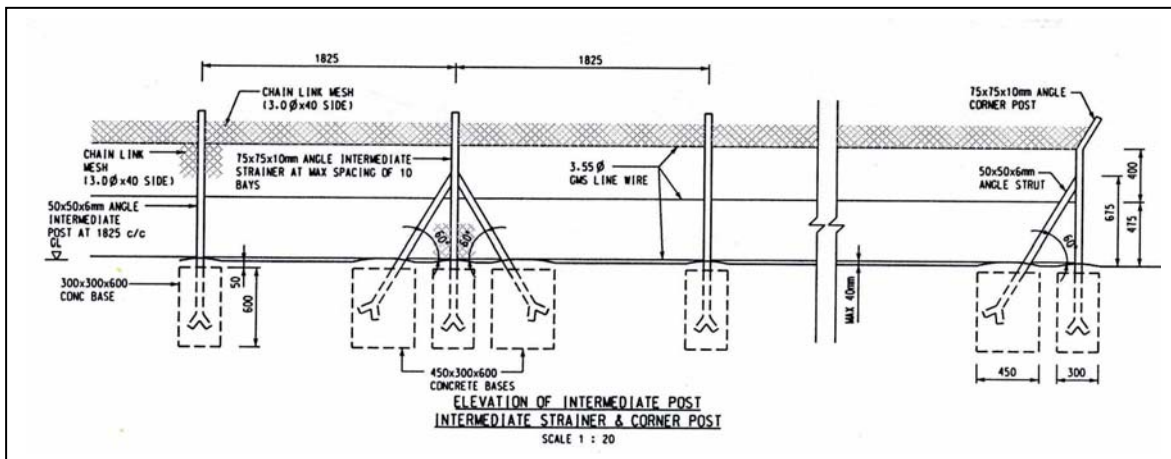

Figure 9. General design of fencing connected to the wildlife underpass in Lok Ma Chau for the project of KCR Lok Ma Chau Terminus and associated works (after Mott Connell, 2004).

### ***Fence top and bottom***

5.5 To discourage animals such as reptiles from climbing over the fence, the top of chain link fencing should have inverted net at an angle of 30 to 90 degrees (Figure 10). For concrete walls, lipped walls could be used to prevent animals such as snakes and frogs that manage to scale the smooth wall surface from climbing over the wall (Figure 11).

Figure 10. Detailed design of the top and bottom of the fencing constructed for the project of Lok Ma Chau Terminus and associated works (after Mott Connell, 2004).

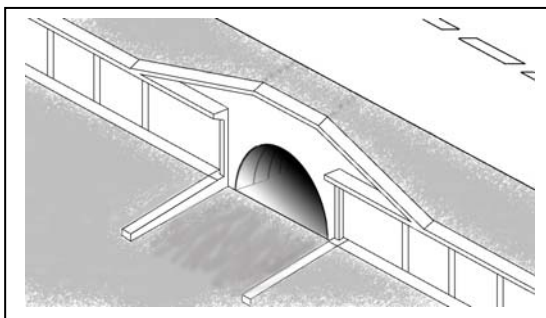
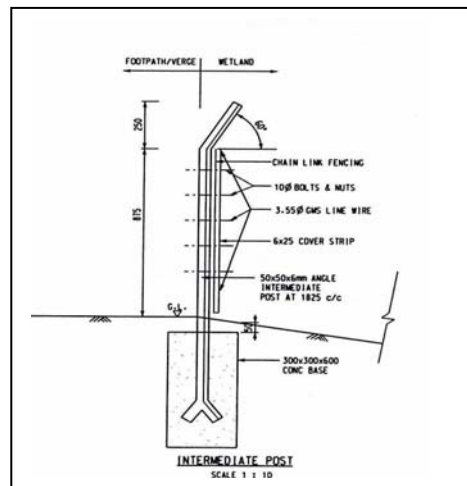

Figure 11. A tunnel underpass with lipped concrete wall for amphibians and reptiles.

5.6 Vegetation such as trees and large bushes that are adjacent to the fence should be kept to the minimum, as they could act as “natural ladders” which facilitate animals climbing over the fence, and hence lessen the effectiveness of the fencing mechanism (Figure 12).

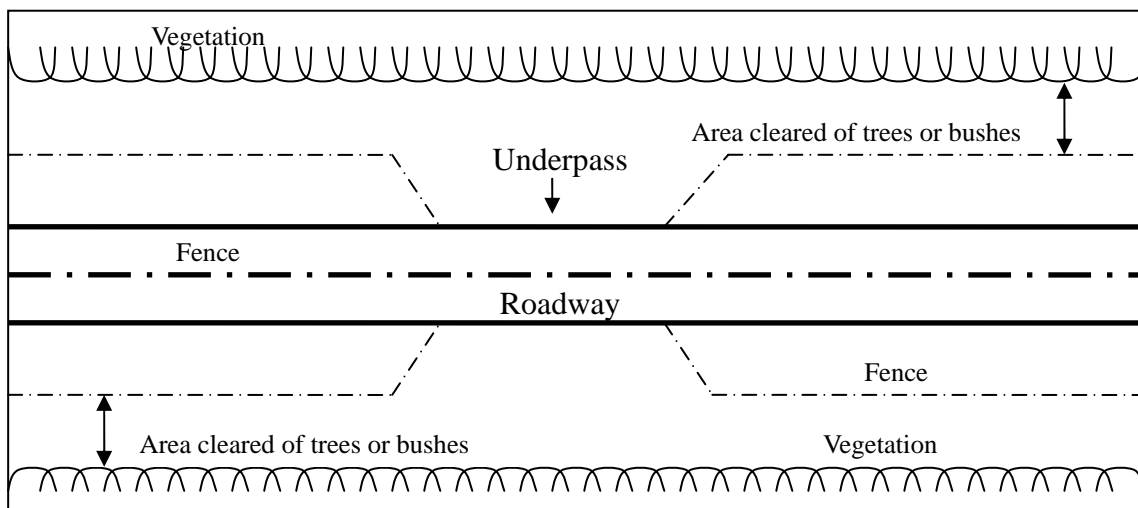

Figure 12. General design of fencing mechanism for a wildlife underpass (modified after USDA Forest Service, 2005).

5.7 Fencing for small mammals, amphibians and reptiles should be specifically designed to prevent the animals from digging under the fence. If the fencing is installed on natural substrate, the fence should be buried to increase stability and at the same time prevent animals from digging under the fence. The depth of the buried section depends on the types of the target species.



### **Escape ramps**

5.8 While underpasses provide connectivity underneath the roads, exits along the fencing should be provided to allow wildlife trapped on the roadway to pass through the fencing, especially when extensive fencing is installed on only one side of underpasses. Common examples of exits from the fencing include one-way gates or escape ramps at regular intervals (Figure 13).

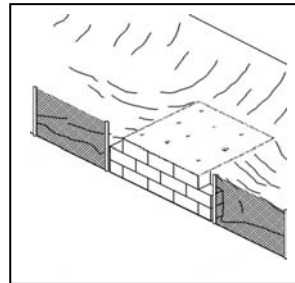

Figure 13. An escape ramp along fencing.

5.9 In areas where amphibians are of particular concern, ramps or breaks in kerbs and drains along the roads could prevent entrapment of these animals. In the Tung Chung Road improvement project, amphibian and reptile escape ramps are incorporated in the U-shaped channels which are 200 to 300 mm deep along the road. The ramps extend 100 mm from the channel wall and face both upstream and downstream. They have a cross-fall angle of 5° dipping into wall of channel to prevent the amphibian and reptile from falling back into the channels, and rise from floor to top of channel at a gentle slope of 10° (Figure 14).

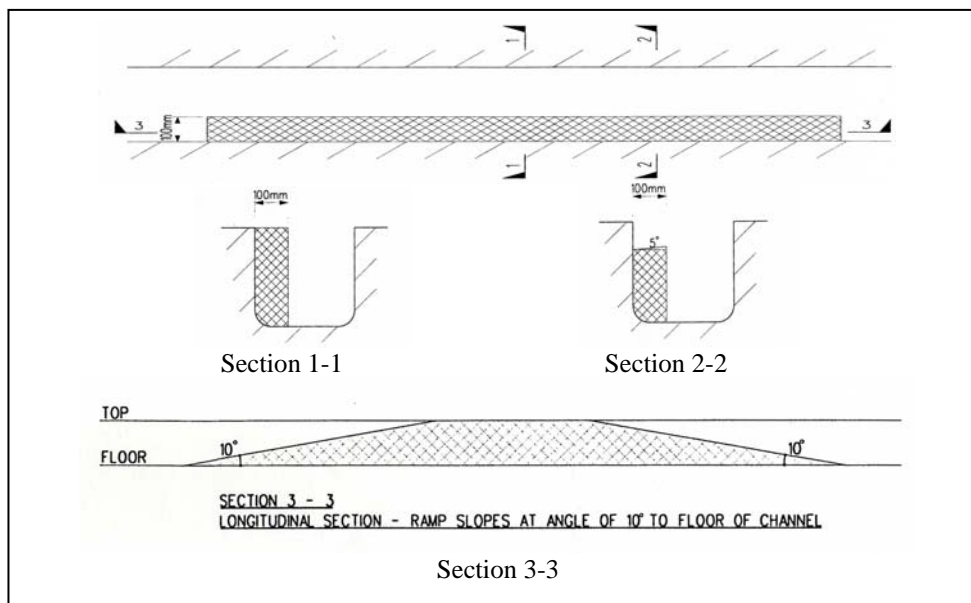

Figure 14. Design of amphibian and reptile escape ramps in U-shaped channels along the improved Tung Chung Road between Lung Tseng Tau and Cheung Sha (after Mouchel, 2002).

## **6. Consideration for different wildlife groups**

6.1 The ecology and behaviour of the target species should be taken into account during the structure design as elements of the design are usually specific to the functional group of the targeted species. For example, a moist substrate is essential for amphibians and reptiles, while mammals are generally indifferent to the substrate surface. On the other hand, openness ratio is important for large mammals but not for amphibians and reptiles. For semi-aquatic species (e.g. Otter), crossing with an appropriate water depth is recommended.

6.2 The terrestrial wildlife groups which are susceptible to barrier effects of infrastructure include mammals (e.g. Masked Palm Civet and Eurasian Otter), reptiles and amphibians (e.g. Romer’s Tree Frogs). These animals can be generally classified into four functional groups, namely large mammals, medium mammals, small mammals and amphibians/reptiles. To accommodate the varying needs of these functional groups, design guidelines that are specific to these groups are suggested in Table 1 for general reference.

Table 1. Specific design guidelines of wildlife underpasses for animal functional groups  
(√ - Best option O - Minimum requirement n.a. - Not Applicable)

Animal Group	Large Mammals	Medium Mammals	Small Mammals	Amphibians / Reptiles
Head-to-body length	> 60 cm	30 – 60 cm	< 30 cm	-
Local Examples	Red Muntjac ( <i>Muntiacus muntjac</i> )  Masked Palm Civet ( <i>Paguma larvata</i> )  Leopard Cat ( <i>Prionailurus bengalensis</i> )  Eurasian Otter ( <i>Lutra lutra</i> )	Chinese Pangolin ( <i>Manis pentadactyla</i> )  East Asian Porcupine ( <i>Hystrix brachyura</i> )  Small Asian Mongoose ( <i>Herpestes javanicus</i> )	Chestnut Spiny Rat ( <i>Niviventer fulvescens</i> )  Indochinese Forest Rat ( <i>Rattus andamanensis</i> )  Musk Shrew ( <i>Suncus murinus</i> )	<u>Amphibian &amp; riparian reptiles</u> Frogs, toads, turtles, some snakes  <u>Upland reptiles</u> Lizards and some snakes
<b>Structure Type</b>				
Pipe culvert	O	O	√	√
Box culvert	O	O	√	√
Bridge underpass	√	√	O	O
<b>Structure Design Guidelines</b>				
Openness Ratio	O (> 0.75)	O (> 0.4)	n.a.	n.a.
Structure Dimension (opening)	n.a.	n.a.	0.2 - 0.4 sq. m.	0.2 – 0.8 sq. m.
Structure Height	> 180 cm	> 100 cm	> 30 cm	> 30 cm
Substrate Moisture	n.a.	n.a.	n.a.	n.a. (upland reptiles) O (amphibian/ riparian reptiles)

## 7. Maintenance and Monitoring

7.1 Maintenance of wildlife underpasses and the associated structures is required to ensure their effectiveness over time. Maintenance of an underpass include clearing debris or other impediments to movement through the structure, replacing shelters such as piles of gravels or vegetative debris and maintaining adjacent habitat to facilitate wildlife movement to the underpass. The structure stability and sign of erosion surrounding or inside the underpass should also be checked for necessary maintenance.

7.2 Maintenance requirement of a fencing mechanism depends on the type of fencing. While short concrete walls provide relatively maintenance-free barriers for small mammals, amphibians and reptiles, wire fencing installed on natural substrate may need regular checking to ensure that the fencing is properly buried.

7.3 Where warranted, monitoring programme should be developed to assess the effectiveness of the wildlife underpasses. Evaluation of the findings would provide valuable information for designing new underpasses in future projects. Effectiveness of an underpass can be indicated by the signs of wildlife usage. Besides the traditional methods of identifying animal dung and footprints found inside the underpasses (e.g. by track plates filled

with soot or gypsum powder or tracking beds with sand or ink), recent technology such as automatic camera and video have been developed to monitor wildlife uses of underpasses.

7.4 **Automatic camera and video** mounted inside underpasses are evolving technologies which make it possible to capture images or even observe the behaviour of the wildlife while utilizing the structures. They are proved effective in documenting animal use of larger underpasses such as bridges or box culverts. Automatic camera was installed inside the wildlife underpass crossing underneath Route 3, and utilization of the tunnel by Masked Palm Civets was detected (Figures 15 &16).



Figure 15. Automatic camera was installed inside the underpass crossing underneath the Route 3 to monitor the wildlife uses of the tunnel.



Figure 16. Picture of a Masked Palm Civet captured by automatic camera when it utilizes the wildlife underpass underneath Route 3.

## 8. Enquires

8.1 Enquiries on this Practice Note should be addressed to the Senior Conservation Officer (Technical Services) at mailbox@afcd.gov.hk.

Agriculture, Fisheries and Conservation Department  
October 2006



### **Further Readings**

Anderson P. (1994). Roads and nature conservation. Guidance on impacts, mitigation and enhancement. English Nature, Peterborough, UK.

Bank *et al.* (2002). *Wildlife Habitat Connectivity across European Highways*. Available at [http://international.fhwa.dot.gov/wildlife\\_web.htm](http://international.fhwa.dot.gov/wildlife_web.htm).

Barnum S. (2003). Identifying the Best Locations to Provide Safe Highway Crossing Opportunities for Wildlife. *The International Conference on Ecology and Transportation (ICOET) 2003 Proceedings*. Available at <http://www.icoet.net/ICOET2003.asp>.

Bennett A.F. (2003). *Linkages in the Landscape. The Road of Corridors and Connectivity in Wildlife Conservation*. IUCN Publications Services Unit, Cambridge, UK.

Byron H. (2000). *Biodiversity and Environmental Impact Assessment: A Good Practice Guide for Road Schemes*. The RSPB, WWF-UK, English Nature and the Wildlife Trusts, Sandy, UK.

Forman R.T.T. *et al.* (2003). *Road Ecology Science and Solutions*. Island Press, Washington, USA.

Kirby K. (1995). *Rebuilding the English Countryside: habitat fragmentation and wildlife corridors as issues in practical conservation*. English Nature, Peterborough, UK.

Sherwood B., Cutler D. and Burton J.A. (ed.) (2002). *Wildlife and Roads. The Ecological Impacts*. Imperial College Press, London.

Mott Connell (2003). *Improvement to Tung Chung Road between Lung Tseng Tau and Cheung Sha. Drawings of Ecological Design Measures – Wildlife Tunnels*. For the Highways Department, HKSAR Government.

Mott Connell (2004). *Lok Ma Chau Terminus and Associated Works. Working Drawings - Proposed Fencing for Wildlife Corridor*. For the Kowloon-Canton Railway Corporation, Hong Kong.

Mouchel (2002). *Improvement to Tung Chung Road between Lung Tseng Tau and Cheung Sha. Investigation and Preliminary Design Assignment. Final Environmental Impact Assessment Report*. For the Highways Department, HKSAR Government.

Rijkswaterstaat (RWS), Dienst Weg- en Waterbouwkunde (DWW), Delft (2001). *De-fragmentation By bits and pieces*. The Directorate-General for Public works and Water Management (RWS), The Government of the Netherlands.

Rijkswaterstaat (RWS), Dienst Weg- en Waterbouwkunde (DWW), Delft (1995). *Nature Across motorways*. The Directorate-General for Public works and Water Management (RWS), The Government of the Netherlands.

Seiler A. (2001). *Ecological Effects of Roads: A review for IENE*. Available at <http://www.iene.info/files/Articles/ASeiler.pdf>.

Shek C.T. and Wan Y.F. (2006). Effectiveness of Animal Crossing at Route 3 by Camera Trapping. *Hong Kong Biodiversity* 12: 8-10.

Spellerberg I.F. (2002). *Ecological Effects of Roads*. Science Publishers, Inc., Enfield, USA.

United States Department of Agriculture Forest Service (2005). *Wildlife Crossing Toolkit*. Available at <http://www.wildlifecrossings.info>.

United States Department of Transportation - Federal highway Administration (2000). *Critter Crossings – Linking Habitats and Reducing Roadkill*. Available at <http://www.fhwa.dot.gov/environment/wildlifecrossings>

---

---

**APPENDIX C**  
**Photos of Landscaping Works**

---

---



## Appendix C – Photos of Landscaping Works



Photo 1



Photo 2



Photo 3



Photo 4



## Appendix C – Photos of Landscaping Works



Photo 5



Photo 6



Photo 7



Photo 8



# Appendix C – Photos of Landscaping Works



Photo 9



Photo 10



Photo 11



Photo 12



**Appendix C – Photos of Landscaping Works**



Photo 13



Photo 14



Photo 15



Photo 16



# Appendix C – Photos of Landscaping Works



Photo 17



Photo 18



Photo 19



Photo 20



## Appendix C – Photos of Landscaping Works



Photo 21



Photo 22



Photo 23



Photo 24



# Appendix C – Photos of Landscaping Works



Photo 25



Photo 26



Photo 27



Photo 28



## Appendix C – Photos of Landscaping Works



Photo 29



Photo 30

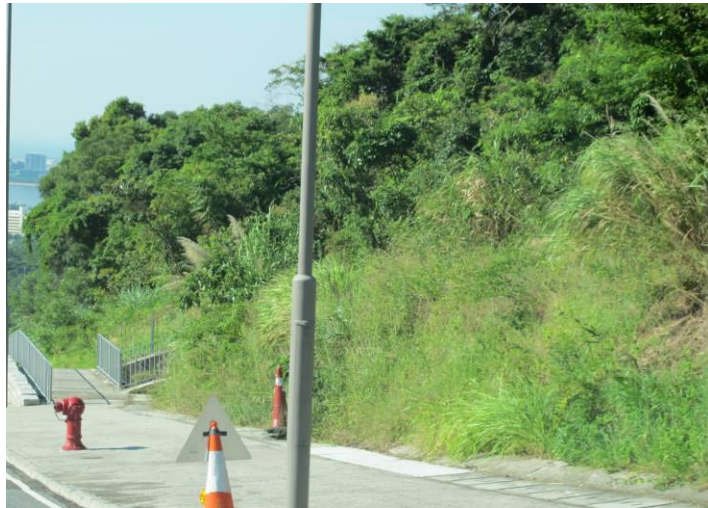

Photo 31



Photo 32



## Appendix C – Photos of Landscaping Works

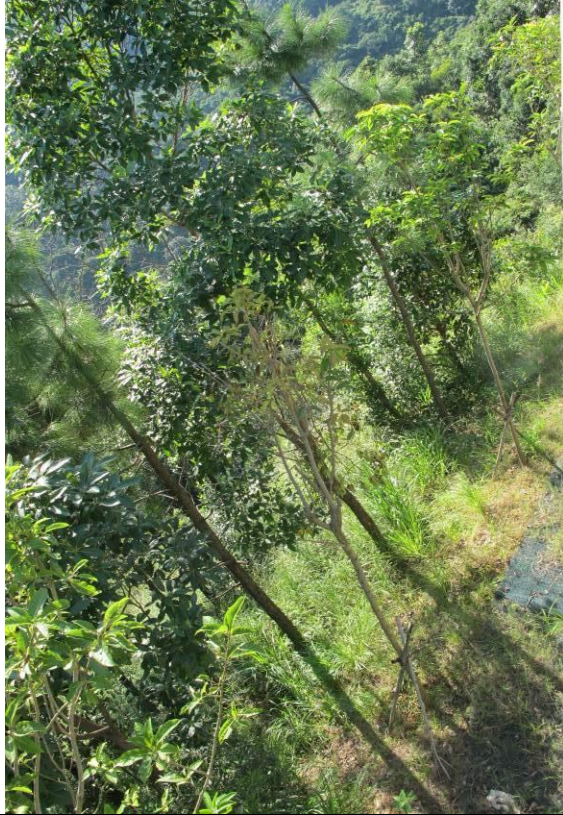

Photo 33



Photo 34



Photo 35

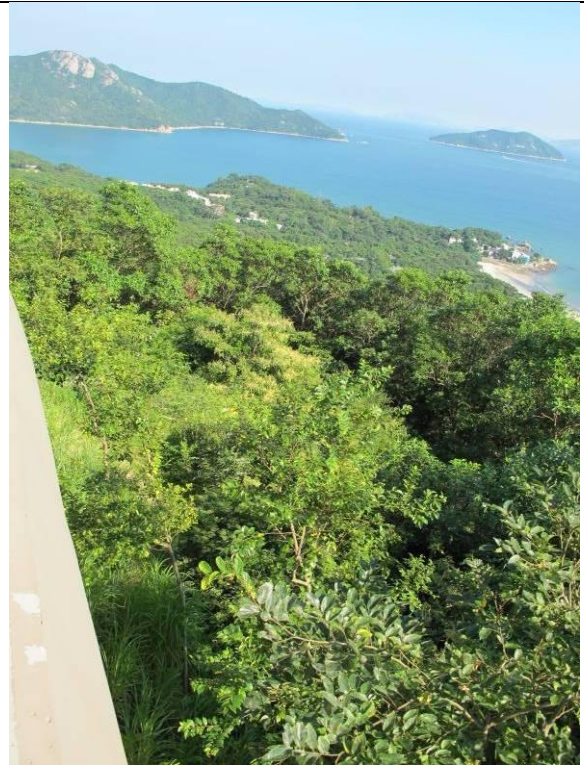

Photo 36