



ANNUAL AUDIT REPORT
For
PERMANENT AVIATION FUEL FACILITY
Environmental Permit
EP-262/2007/B

Date of Audit :		27 February to 20 March 2020
Prepared By :	Michael Chung, Senior Engineer <i>mchung</i>	20 March 2020
Reviewed By :	Eddie Kwan, Facility Manager <i>Eddie Kwan</i>	20 March 2020
Approved By :	Tommy Siu, General Manager <i>Tommy Siu</i>	20 March 2020



Table of Contents

Annual Audit Report

Introduction

Purpose and Scope

Conclusion

Audit Details

- Conditions set out in the Environmental Permit

Appendix 1 - The Auditor

Appendix 2 - Level Alarm Settings for Each Storage Tank

Appendix 3 - Photos No. 1 to 39

Appendix 4 - Seabed Level Survey Result

Appendix 5 - Drawings

Introduction

ECO Aviation Fuel Services Limited (EAFS) is the operator of the Permanent Aviation Fuel Facility (PAFF), which is located on 9.28 ha of land at 9 Lung Hong Street, Tap Shek Kok, Tuen Mun. PAFF consists of a tank farm, a twin berth jetty and associated pipelines for receipt of aviation fuel from ocean tankers to the tank farm, and twin submarine pipelines from the tank farm to the aviation fuel receipt facility at Sha Chau Island.

PAFF is accredited with ISO14001 and OHSAS18001.

The tank farm has eight storage tanks of which six (6) 35,000m³, one (1) 32,000m³ and one (1) 22,000m³ respectively thus providing a total storage capacity of 264,000m³. The tank farm is provided with bund walls and a contained drainage system.

Other facilities within PAFF include a pump platform, where the pumps, filters and recovery system are located. An administration building houses the control room, security control, backup power generator, firefighting equipment, transformers, switch room and workshop.

Aviation fuel is unloaded at a twin berth jetty located approximately 200 meters offshore where water depth is about 17m. The jetty is constructed on tubular piles and designed for berthing tankers of deadweight tonnage ranging from 10,000 to 80,000.

Aviation fuel is transferred to Hong Kong International Airport (HKIA) by means of twin subsea 500mm diameter pipelines to the Sha Chau island custody transfer facility located at 4.4 kilometers south of PAFF. The transfer pipelines are installed with cathodic protection system and leak detection system.

In summary, PAFF is for storage and delivery of aviation fuel to HKIA.

Purpose and Scope

This Annual Audit reviews the performance of the design arrangements and measures mentioned in Condition 3.5 of the Environmental Permit (EP-262/2007/B).

In this report, there are photos and inspection records made available for review. The photos and inspection records that have been attached are representative of the facilities and associated operation process.

Conclusion

The results of the Year 2019 Annual Audit reveal that the Environmental Permit Condition 3.5 requirements are adhered.

Audit Details

Results are designated as “C” for Conformance, “O” for Observation and “NC” as Non-Conformance.

1 Conditions Set Out in the Environmental Permit

1.1 Containment Systems of Aviation Fuel Storage Tank Farm

1.1.1 All aviation fuel storage tanks shall be located in bunded compounds with capacity of more than 110% of the contents of the largest aviation fuel storage tank in the bunded compounds.

Observation	Result
<p>It was confirmed in the Design Audit Report dated October 2010 that :-</p> <ol style="list-style-type: none"> 1. The tank farm storage consists of two bunds each designed to have six tanks, of which 4 tanks in each bund (a total of 8 tanks) have been built. 2. The calculation of bund wall containment volume in Drawing PAFF/RJ/02/DWG/G/3015(EX) shows that the current containment capacities of each of the two bunds are far greater than 150% of the largest aviation fuel storage tank in the bunded compounds. 3. Both bunds are interconnected for the overflow so that in normal circumstances, the overall containment capacity is double the size of a single bunded compound, or greater than 300% of the largest tank for the 8 tank facility. 4. The design meets the I.P. Code Part 19 “Fire Precautions at Petroleum Refineries and Bulk Storage Installations” item 3.4.2.5.5 and the Hong Kong “Code of Practice for Oil Storage Installation” item 4.1. <p>There had been no change made after the completion of construction since October 2010. Photographs No. 1 & 2 show that all eight tanks are located within bunded compounds.</p>	<p>C</p>

1.1.2 The bunds shall be partly sunken below the level of ground outside the bunds.

Observation	Result
<p>It was confirmed in the Design Audit Report dated October 2010 that :-</p> <ol style="list-style-type: none"> 1. Drawings PAFF/BA/02/DWG/C/1721-1724 illustrate that the bunds have been designed to be partly sunken below ground level outside the bunds in the EVA. <p>There had been no change made after the completion of construction since October 2010. Photographs No. 3 & 4 show that both bunded areas are lower than the ground level outside the bunds.</p>	C

1.1.3 Wave Deflector shall be used at the bunds.

Observation	Result
<p>It was confirmed in the Design Audit Report dated October 2010 that :-</p> <ol style="list-style-type: none"> 1. Drawings PAFF/BA/02/DWG/C/1721-1724 illustrate the design and installation of wave deflectors on the bund walls.” <p>There had been no change made after the completion of construction since October 2010. Photograph No. 5 shows that wave deflectors are located at top of the bunds.</p>	C

1.1.4 Fire-retardant joints shall be used at the bunds.

Observation	Result
<p>It was confirmed in the Design Audit Report dated October 2010 that :-</p> <ol style="list-style-type: none"> 1. Drawings PAFF/BA/02/DWG/C/1722-1724 illustrate the design and installation of special fire-retardant joints at the bunds. The components consist of Flexcell Compressible Filler and Nelson Fire Stop Product ES1399 Joint Sealant (capable of 4 hours of fire resistance). All visible parts of the joints are covered by stainless steel plates on the inside. <p>There had been no change made after the completion of construction since October 2010. For phase 1a bund, the external steel plates are fixed in. For phase 1b bund, the steel plates are embedded in the concrete and span across the construction joint. Photographs No. 6 & 7 show that visible parts of the joints are covered by stainless steel plates on the inside at phase 1a.</p>	C

1.1.5 Intermediate bund walls shall be designed and constructed within the bunded compounds for each aviation fuel storage tank.

Observation	Result
<p>It was confirmed in the Design Audit Report dated October 2010 that :-</p> <p>1. Drawings PAFF/BA/02/DWG/C/1452 & PAFF/LC/02/DWG/C/0551 illustrate the construction of internal bund (intermediate bund) walls within the bunded compounds for each aviation fuel storage tank meeting the I.P. Code Part 19 “Fire Precautions at Petroleum Refineries and Bulk Storage Installations” item 3.4.2.5.4.</p> <p>There had been no change made after the completion of construction since October 2010. Photographs No. 8 & 9 show that intermediate bund walls are in place.</p>	<p>C</p>

1.1.6 Two impervious security walls shall be designed and constructed outside the bunded compounds.

Observation	Result
<p>It was confirmed in the Design Audit Report dated October 2010 that :-</p> <p>1. Drawings PAFF/BA/02/DWG/C/1721-1724 illustrate the construction of two impervious security walls outside the bunded compounds as the tertiary and fourth containments after the tank itself as the primary containment and bund wall as the secondary containment.</p> <p>There had been no change made after the completion of construction since October 2010. Photographs No. 10 & 11 show that two impervious security walls outside the bunded compounds are complete in place.</p>	<p>C</p>

1.1.7 A landscaped berm of at least 1.5m high shall be designed and constructed outside the bunded compounds.

Observation	Result
<p>It was confirmed in the Design Audit Report dated October 2010 that :-</p> <p>1. Drawing PAFF/BA/02/DWG/C/1481 illustrates a landscaped berm of at least 1.5m high outside the outer security wall.”</p> <p>There had been no change made after the completion of construction since October 2010. Photographs No. 12 & 13 show that a landscaped berm of at least 1.5m high outside the outer security wall is in place and properly maintained.</p>	<p>C</p>

1.1.8 Gates at the security walls shall be properly designed and constructed to provide sealing in case of any fuel spillage within the aviation fuel storage tank farm.

Observation	Result
<p>It was confirmed in the Design Audit Report dated October 2010 that :</p> <p>1. Drawing PAFF/BA/02/DWG/C/1727 illustrates that solid gates at the security walls would provide sealing in case of any fuel spillage outside the bunded areas within the aviation fuel storage tank farm.”</p> <p>There had been no change made after the completion of construction since October 2010. Photographs No. 14 & 15 show that the gates at security walls are in place.</p>	<p>C</p>

- 1.1.9 All the bund and security walls shall be properly designed and constructed using reinforced concrete to provide sufficient structural strength to withstand any liquid surge load in case of any accidents.

Observation	Result
<p>It was confirmed in the Design Audit Report dated October 2010 that :</p> <ol style="list-style-type: none"> 1. Drawings PAFF/BA/02/DWG/C/1726, 1728, and 1730 illustrate that all the bund and security walls are constructed by reinforced concrete to provide sufficient structural strength to withstand any liquid surge load in case of any accident.” <p>There had been no change made after the completion of construction since October 2010. Photographs No. 16 & 17 show that all the bund and security walls are in place.</p>	<p>C</p>

1.2 **Drainage Isolation and Lining System for Aviation Fuel Storage Tank Farm**

- 1.2.1 Drainage system shall be properly designed and constructed for the aviation fuel storage tank farm to collect aviation fuel in case of spillage.

Observation	Result
<p>It was confirmed in the Design Audit Report dated October 2010 that :</p> <ol style="list-style-type: none"> 1. The drainage layout plans in Drawings PAFF/BA/02/DWG/C/1452 & PAFF/LC/02/DWG/C/0551 illustrate the construction of the drainage systems with appropriate falls and gradients to collect aviation fuel in case of spillage. 2. The design meets the Hong Kong “Code of Practice for Oil Storage Installation” item 6.2.1. <p>There had been no change made after the completion of construction since October 2010. Photographs No. 18 & 19 show that the impervious lining is in good condition and the drainage falls towards interceptor for collection.</p>	<p>C</p>

1.2.2 Valves and oil interceptors shall be properly designed and constructed at the drainage system to prevent any oily discharge to the sea.

Observation	Result
<p>It was confirmed in the Design Audit Report dated October 2010 that :</p> <ol style="list-style-type: none"> The drainage layout plans in Drawings PAFF/BA/02/DWG/C/1452 & PAFF/LC/02/DWG/C/0551 illustrate the installation of oil interceptors and valves before the drainage outlets of bunded areas. The oil interceptors are designed to intercept and contain spillage while the valves are normally kept in close position as further precaution. They will be opened to release storm water inside the bunded areas as necessary. The design meets the Hong Kong “Code of Practice for Oil Storage Installation” item 7.1. <p>There had been no change made after the completion of construction since October 2010. Photographs No. 20 & 21 show that the valves at the oil interceptors and are kept in normal-close position.</p>	<p>C</p>

1.2.3 Impermeable lining shall be installed underneath all aviation fuel storage tanks to prevent seepage of aviation fuel to ground.

Observation	Result
<p>It was confirmed in the Design Audit Report dated October 2010 that :</p> <ol style="list-style-type: none"> Drawing PAFF/BA/02/DWG/C/1705 illustrates the installation of impermeable lining underneath all aviation fuel storage tanks and within the bunded areas to prevent seepage of aviation fuel to the ground due to leakage from the storage tanks. This meets the I.P. Code Part 19 “Fire Precautions at Petroleum Refineries and Bulk Storage Installations” item 3.4.2.5.2. “ <p>There had been no change made after the completion of construction since October 2010. Photographs No. 22 & 23 show construction record of the impermeable lining at various locations.</p>	<p>C</p>

1.3 **Overfilling Monitoring System and Leakage Detection System**

1.3.1 Tank overfilling monitoring systems shall be properly designed and constructed for the Project.

Observation	Result
<p>It was confirmed in the Design Audit Report dated October 2010 that :</p> <ol style="list-style-type: none"> 1. Tank overfilling monitoring system is in place for each tank. 2. Alarms are set by means of the level gauge of each tank and will trigger an alarm by the SCADA system for operator alert. 3. Additional alarms were designed to supplement the 1st level protection system and independent level switches are installed for the high-high levels and would trigger Emergency Shutdown for the specific tank inlet valve immediately together with an audible alarm for the control room operator. <p>According to appendix 2, PAFF has strict control to monitor and protect storage tanks from overfilling. The normal-fill-level and high level alarms have been set by means of the level gauge of each tank and would trigger alarm for operator alert. The high-high level alarm is set by electronic level gauge of each tank and would trigger an Emergency Shutdown of the tank inlet valves. A critical high alarm is installed to supplement the 1st level protection system of which an independent level switch is installed for detecting the critical high level and would trigger an Emergency Shutdown of the tank inlet valves. PAFF performs regular inspection on the functionality of the level alarms with traceable records. Photographs No. 24, 25 & 26 show that the high level alarm setting in the SCADA system, the regular testing on the high-high level alarm and test record.</p>	<p>C</p>

1.3.2 Pipeline leakage detection system shall be properly designed and constructed for the Project.

Observation	Result
<p>It was confirmed in the Design Audit Report dated October 2010 that :</p> <ol style="list-style-type: none"> 1. Drawings PAFF/LC/01/DWG/M/0202-3 & 0207 illustrate the installation of pipeline leakage detection system in the subsea pipelines using COWI Stat Leak System software. The test is carried by closing inlet/outlet section of specific pipelines and measure pressure drop within a specified time period within the pipeline. A pressure drop not due to thermal effect may indicate a possible leak in the pipeline and will generate an alarm for immediate investigation. <p>The Leak Detection System and associated instrumentation were installed and the software had been updated by the vendor after the completion of construction in October 2010. Photograph No. 27 shows the Leak Detection System is installed on the computer.</p>	<p>C</p>

1.3.3 Impermeable lining leakage detection system shall be properly designed and constructed for the Project.

Observation	Result
<p>It was confirmed in the Design Audit Report dated October 2010 that :</p> <ol style="list-style-type: none"> 1. Drawing PAFF/BA/02/DWG/C/1705 illustrates the installation of 80mm diameter leak detection pipe in accordance with API 650 underneath the sump of each storage tank. 2. The head of the pipe is perforated and designed to situate above the containment membrane of the tank base with the pipe descending to the end outside the tank ring base, ensuring the pipe will collect and drain out fuel, if any, to a designated containment well at the tank side. Therefore, any leakage from the bottom of the storage tank would be detected and the banded areas are laid with impervious membrane to contain fuel spillage. 3. The construction of this design has been implemented for all tanks. <p>There had been no change made after the completion of construction since October 2010. Photographs No. 28 & 29 show the tell-tale pipe installed and the as-built fuel collection chamber.</p>	<p>C</p>

1.3.4 Emergency shutdown (ESD) systems shall be properly designed and constructed for the Project. All ESD systems shall be equipped with manual initiating devices.

Observation	Result
<p>It was confirmed in the Design Audit Report dated October 2010 that :</p> <ol style="list-style-type: none"> 1. Drawings PAFF/KG/02/DWG/E/7437 & LC/03/DWG/M/0251 show the installation of manual-operated emergency shutdown (ESD) buttons at the strategic points in the tank farm and on the jetty for emergency use. 2. As soon as ESD is activated, all valves and delivery pumps will shut down automatically to isolate the fuel lines and stop fuel flow. The installation of ESD is in place. <p>There had been no change made after the completion of construction since October 2010. Regular inspection is performed on the ESD functionality with records kept in the maintenance system. Photographs No. 30 & 31 show the ESD system and the regular testing.</p>	<p>C</p>

1.3.5 The ESD system shall be initiated automatically in case of actuation of fire alarm system, overfilling monitoring system of aviation fuel storage tanks and leakage detection system of sub-sea pipelines.

Observation	Result
<p>It was confirmed in the Design Audit Report dated October 2010 that :</p> <ol style="list-style-type: none"> 1. Drawings PAFF/LC/01/DWG/M/0202 – 0203 & 0207 illustrate the installation of ESD system which will be triggered automatically in case of actuation of fire alarm system, overfilling monitoring system of aviation fuel storage tanks and leakage detection system of sub-sea pipelines. The installations are in place. <p>There had been no change made after the completion of construction since October 2010. PAFF performs regular inspection on the functionality of the ESD interface with records kept. Photographs No. 32, 33, 34 & 35 show the regular testing on the ESD interface and testing record.</p>	<p>C</p>

1.4 **Installations at the Jetty**

1.4.1 The jetty shall be installed with defensive fenders.

Observation	Result
<p>It was confirmed in the Design Audit Report dated October 2010 that :</p> <ol style="list-style-type: none"> On top of the standard fender system engineered to suit the full range of vessel sizes and types expected to use the berth, drawings PAFF/MA/03/DWG/C/2807-2808 illustrate the installation of defensive fenders on the shore side of the jetty and end protection units to protect against possible collision from small craft straying into the area. The defensive fenders are in place. <p>There had been no change made after the completion of construction since October 2010. Photographs No. 36, 37 & 38 show that the fender system is installed both at sea side and shore side of the jetty.</p>	<p>C</p>

1.4.2 The jetty shall be installed with coupling points with slop collection utilities connecting to oil interceptors.

Observation	Result
<p>It was confirmed in the Design Audit Report dated October 2010 that :</p> <ol style="list-style-type: none"> Drawing PAFF/LC/03/DWG/M/0251 illustrates the provision of oil interceptors and bunded areas to contain any dripping from the coupling equipment after disconnection from the ships and the minor spill will go into the slop collection utilities connecting to the oil interceptors. <p>There had been no change made after the completion of construction since October 2010. Photographs No. 39 shows that the slop collection utilities are installed to recover excess aviation fuel during coupling and de-coupling.</p>	<p>C</p>

1.5 Sub-sea Pipelines Protective Measures

1.5.1 The sub-sea aviation fuel transfer pipelines shall be properly designed and constructed to prevent or minimize any damage or leakage risk. The sub-sea pipelines shall be protected in accordance with the arrangement as shown in Figure 5 of the Environmental Permit No. EP-262/2007/B. The sub-sea pipelines shall be buried at least 3m below the seabed level and covered with protective armour rock layer of at least 1.2m thick. No protective armour rock layer shall be protruded above the seabed.

Observation	Result
<p>It was confirmed in the Design Audit Report dated October 2010 that :</p> <ol style="list-style-type: none"> 1. Drawing PAFF/LC/04/DWG/C/0408 illustrates the sub-sea pipelines in accordance with the arrangement as shown in Figure 5 of the Environmental Permit EP-262/2007/B. 2. The sub-sea pipelines have been installed in a dredged trench and have been buried at least 3m below the seabed level and covered with protective armour rock layer of at least 1.2m thick. 3. The protective armour rock layer does not protrude above the seabed. 4. The installation is in good order. <p>There had been no change made after the completion of construction since October 2010.</p> <p>According to the latest hydrographic survey result in January 2019 (attached in Appendix 4) and there is no evidence of damage to the rock-fill protection layer over the subsea pipelines.</p>	<p>C</p>



Appendices



Appendix 1 – The Auditor – Mr. Michael, M.K. Chung

Mr. Chung is the Senior Engineer of EAFS responsible for project engineering and maintenance matters of the Permanent Aviation Fuel Facility.

Mr. Chung holds a Bachelor Degree in Mechanical Engineering and a Master Degree in Business Administration.

Mr. Chung participated in the PAFF design 2002 with in-depth involvement in the construction, testing and commissioning. He had solid experience in plant construction, maintenance and operation with EAFS' parent organization, the Hong Kong and China Gas Company Limited since 1995.

Appendix 2 – Level Alarms Settings for Each Storage Tank

Tank Operating and Overfill Alarm Setting

As per American Petroleum Institute guideline “API 2530-2012”

Permanent Aviation Fuel Facility (PAFF)

I. PRIMARY DATA

1. Demonstrated response time to close tank outlet and inlet valves when an alarm is activated = “A” min.
2. Volume transferred into the tank for a period of “A” min. = “B” m³
3. Volume “B” m³ with 1.5 factor of safety margin = “C” m³

II. ALARM AND FILL LEVEL SETTINGS

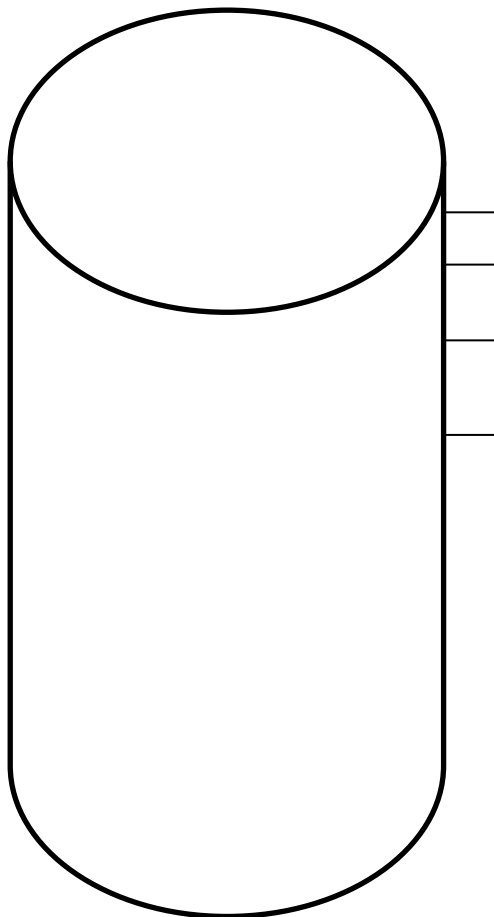

Level Descriptions	Actions and Alarms
Critical Height (CH) = Independent Level Switch Setting and/or High High Level Alarm	Shutdown Alarm + Close inlet / Outlet Valves
High-High Level Alarm (HHLA) = CH – “C”	Shutdown Alarm + Close Inlet / Outlet Valves
High Level Alarm (HLA) = HHLA – “C”	High Alarm
Normal Fill Level (NFL) = NFL	Annunciation

Appendix 3 – Photos No. 1 to 38



(1) Four tanks are located within bunded compound – Phase 1a



(2) Four tanks are located within bunded compound – Phase 1b



(3) Phase 1a bunded compound is lower than the ground level outside the bunds



(4) Phase 1b bunded compound is lower than the ground level outside the bunds



(5) Wave deflector is located at top of the bund



(6) Visible parts of the joints are covered by stainless steel plates on the inside at phase 1a bund



(7) Maintenance works have been performed on sealant at joints

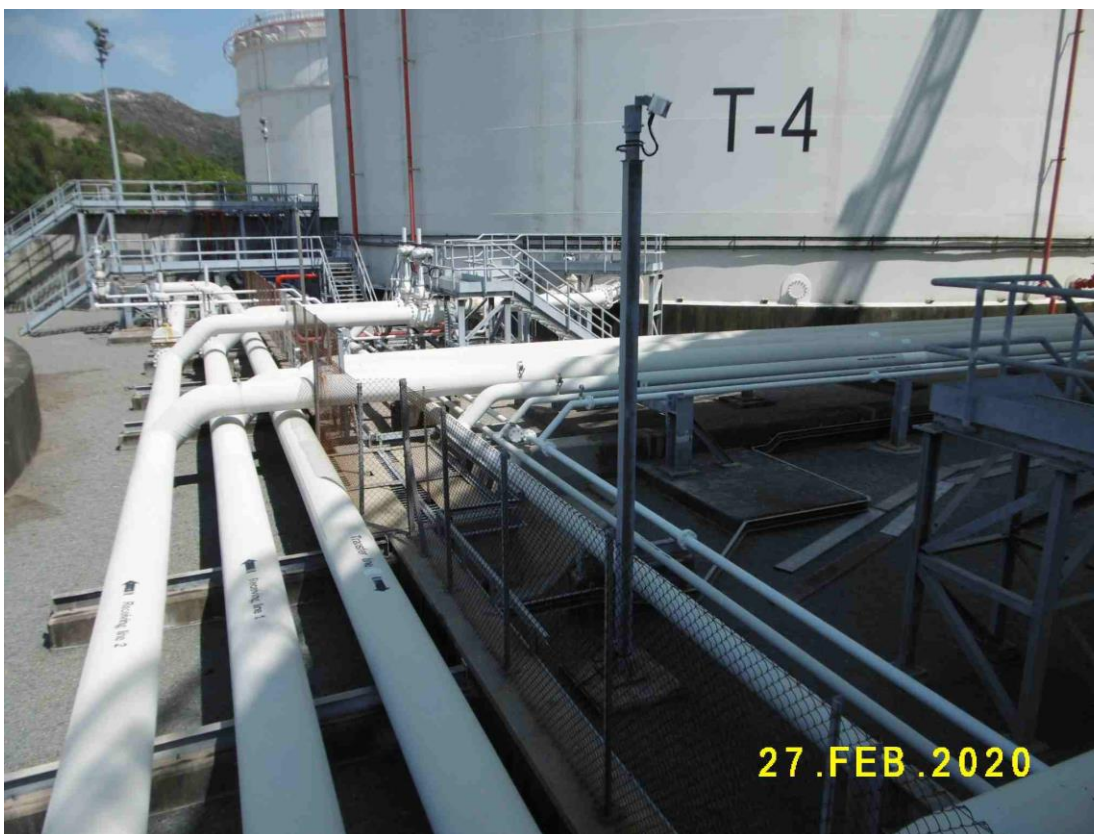

(8) Intermediate bund walls are provided in place near T-01-004



(9) Intermediate bund walls are provided in place near T-01-002



(10) Two impervious security walls are provided outside the bunded compounds



(11) Two impervious security walls are provided outside the bunded compounds

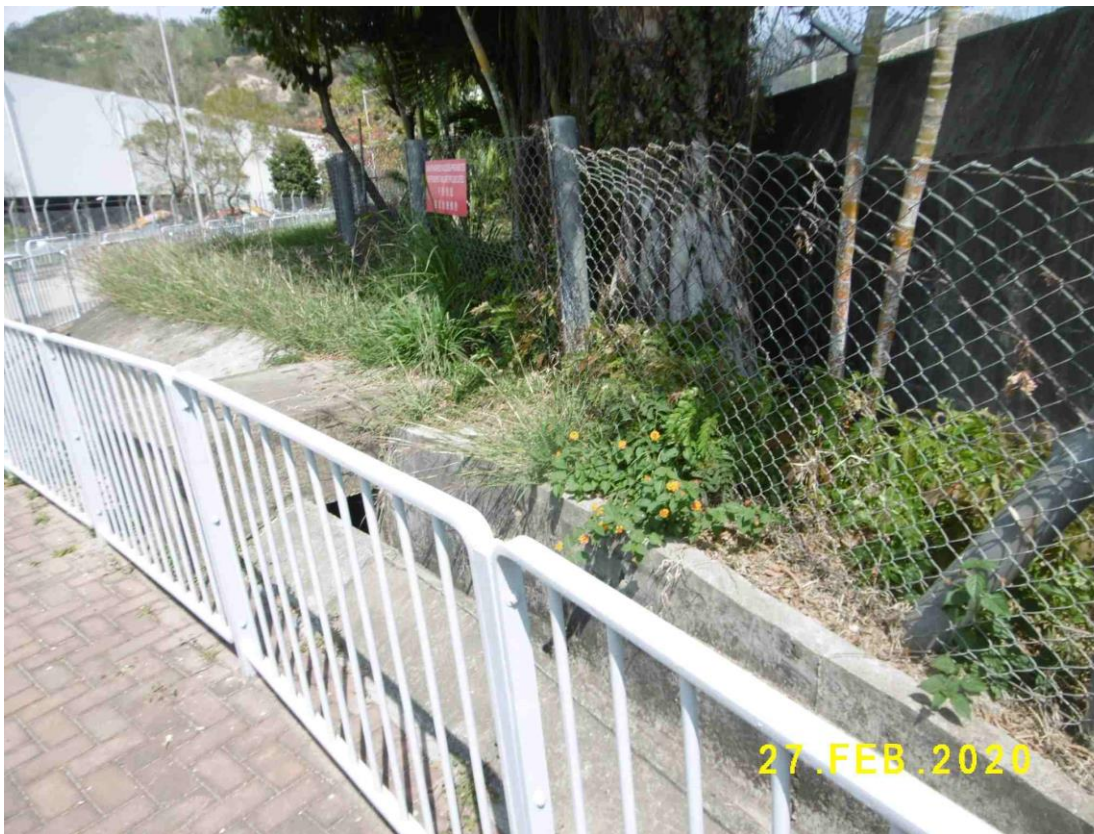

(12) Landscaped berm is maintained at least 1.5m high



(13) Landscaped berm is maintained at least 1.5m high



(14) Gates at security walls with sealant are maintained in good condition



(15) Gates at security walls with sealant are maintained in good condition



(16) This shows the thickness of the bund wall provided



(17) This shows the thickness of the security wall provided



(18) Impervious lining are maintained in good condition



(19) Tank farm is with appropriate gradient and the drainage falls to interceptor for collection



(20) Outlet valve provided for Phase 1a Interceptor with instruction sign to keep "normally closed"



(21) Outlet valve provided for Phase 1b Interceptor with instruction sign to keep “normally closed”



(22) Record photo shows impervious membrane being installed on top of tank foundation



(23) Record photo shows imperious membrane laid at tank center sump with tell-tale pipe embedded for leak detection

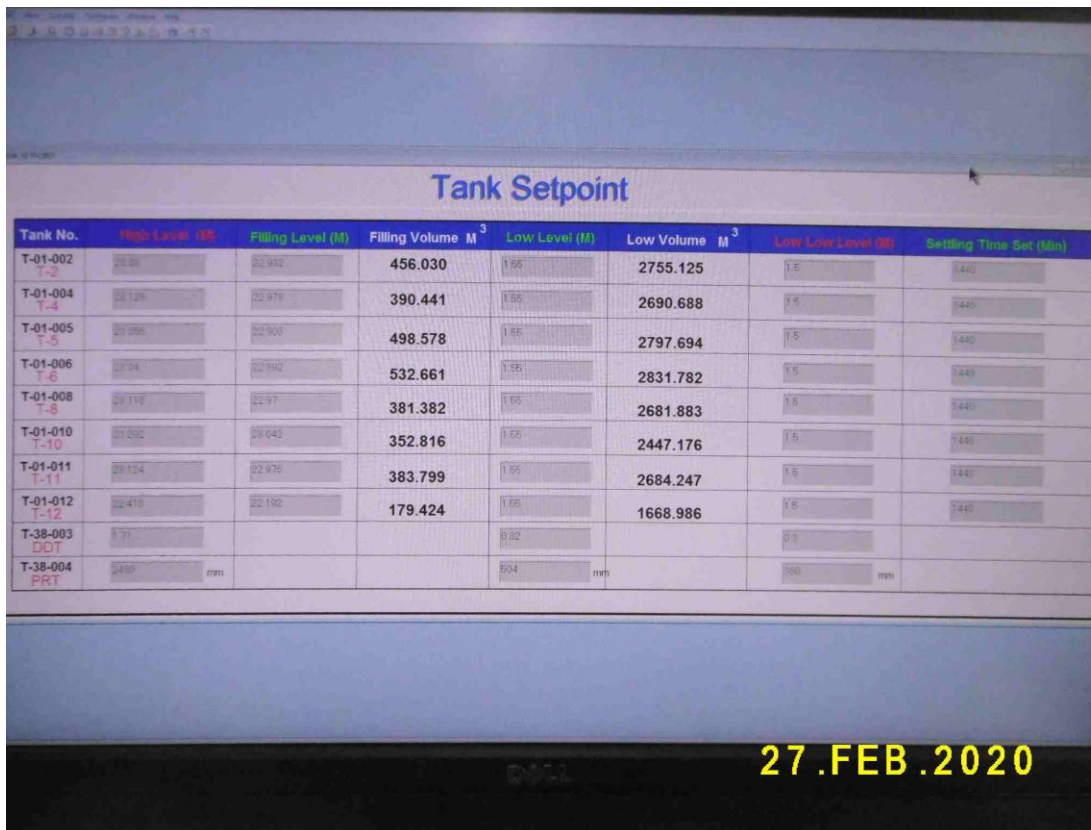

Tank No.	High Level (M)	Filling Level (M)	Filling Volume M ³	Low Level (M)	Low Volume M ³	Low Low Level (M)	Settling Time Set (Min)
T-01-002 T-2	22.26	22.952	456.030	1.55	2755.125	1.5	1440
T-01-004 T-4	22.126	22.975	390.441	1.55	2690.688	1.5	1440
T-01-005 T-5	22.296	22.905	498.578	1.55	2797.694	1.5	1440
T-01-006 T-6	22.334	22.992	532.661	1.55	2831.782	1.5	1440
T-01-008 T-8	22.112	22.97	381.382	1.55	2681.883	1.5	1440
T-01-010 T-10	22.292	22.042	352.816	1.55	2447.176	1.5	1440
T-01-011 T-11	22.124	22.976	383.799	1.55	2684.247	1.5	1440
T-01-012 T-12	22.418	22.192	179.424	1.55	1668.986	1.5	1440
T-38-003 DDT	0.71			0.32		0.2	
T-38-004 PRT	2450 mm			504 mm		300 mm	

(24) High Level Alarm being set in the SCADA System



(25) Regular inspection performed on overfilling monitoring device (High-High Level Alarm)



Aviation Fuel Facility

ECO Aviation Fuel Services Ltd

Operation Surveillance Form

Site Name	Surveillance Conducted By	Surveillance Date
Permanent Aviation Fuel Facility	Organization ECO Aviation Fuel Services Limited	10 / 02 / 2020
	Name:	

Tank No.	T-01-002
-----------------	-----------------

Item No	Item	Acceptance Criteria/Ref. Standard	Compliance		Note Fault & Rectification Completed/Action Required.
			Yes	No	
1.0	Tank Structure				
1.1	Tank Shell	Any areas of flaking paint or corrosion. Note wind girder and floor to shell areas?		✓	
1.2	Tank Shell joints	Any signs of any weeping, leaks or wetness from any of the welded or riveted shell joints?		✓	
1.3	Stairs, handrails and walkways.	Any corrosion areas or flaking paint on stairways, treads, walkways, handrails. & underside of stair landings. Any structural damage?		✓	
1.4	Fixed Roof	Any visible damage, excessive corrosion or abnormal penetrations in roof plates?		✓	
2.0	Foundation				
2.1	Foundation shape	Is the original foundation shape retained?	✓		
2.2	Foundation	Are there signs of cracks or differential settlement? Does it allow water to drain away from the tank edge?		✓	
2.3	Foundation water retention	Are there signs that water is retained on shoulder areas?		✓	
3.0					
3.1	Valve operation	Are the valves free to operate and do the spindles have lubrication?	✓		
3.2	Security Valve and openings	Are all the valves not open/in use locked? Are all spare nozzles, drain points etc. positively secured by cap, plug or blank?	✓		
3.3	Vents	Are vents operating correctly, no blockage by insects or bird nests?	✓		
3.4	Pressure vacuum vent operation	Is the vent sealing? Are there sources of vapour leakage from other tank roof fittings?		N/A	
3.5	Manometer	Correct operation, no cracks or damage?		N/A	
3.6	Earthing connection and conductors	Is there any fraying of cables, or damaged or corroded conductors, connections or earth s takes?		✓	
3.7	Other tank roof fittings	Are the y all in serviceable condition, free from damage and corrosion?	✓		

3.1.1 Vertical Tank Monthly Inspection Form

- (26) Record for regular inspection performed on overfilling monitoring device (High-High Level Alarm)

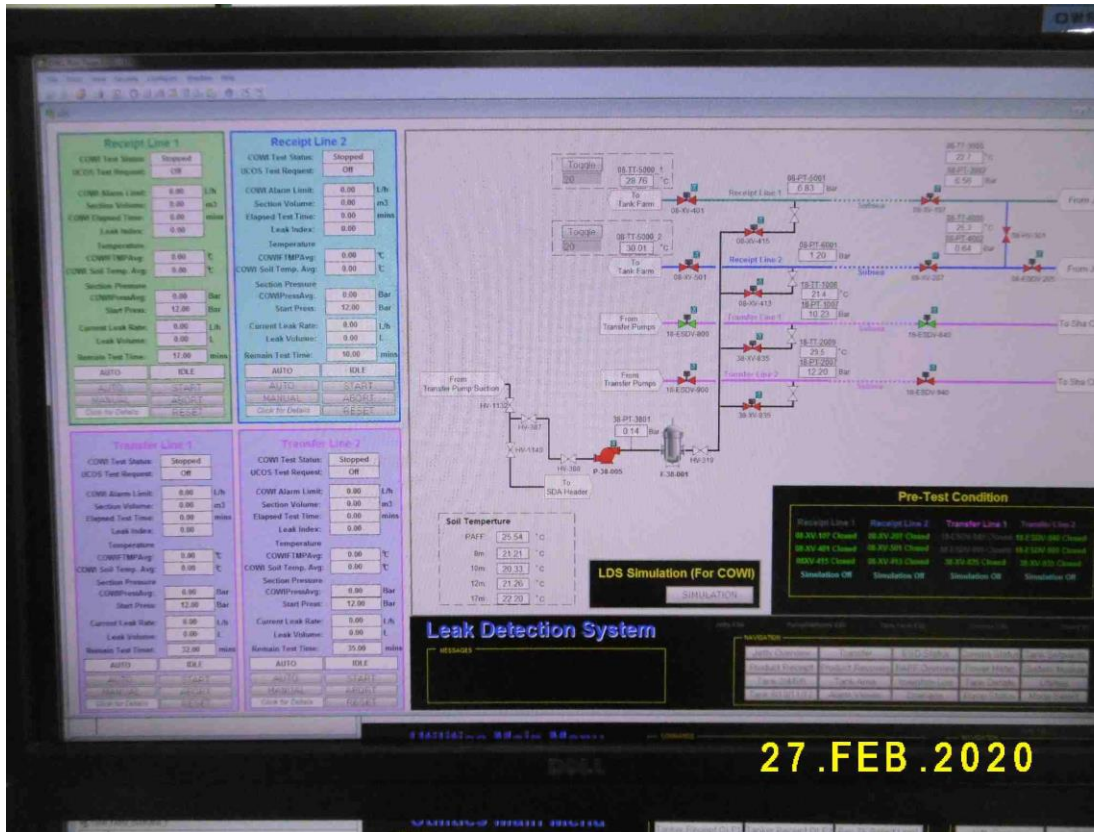

(27) Leak detection “COWI Stat Leak System” installed into computer



(28) Leak detection tell-tale pipe underneath the storage tank opens out to a collection chamber



(29) Collection chamber located adjacent to tank foundation is maintained in good condition with periodic inspection



(30) ESD device is maintained in good condition and being tested periodically

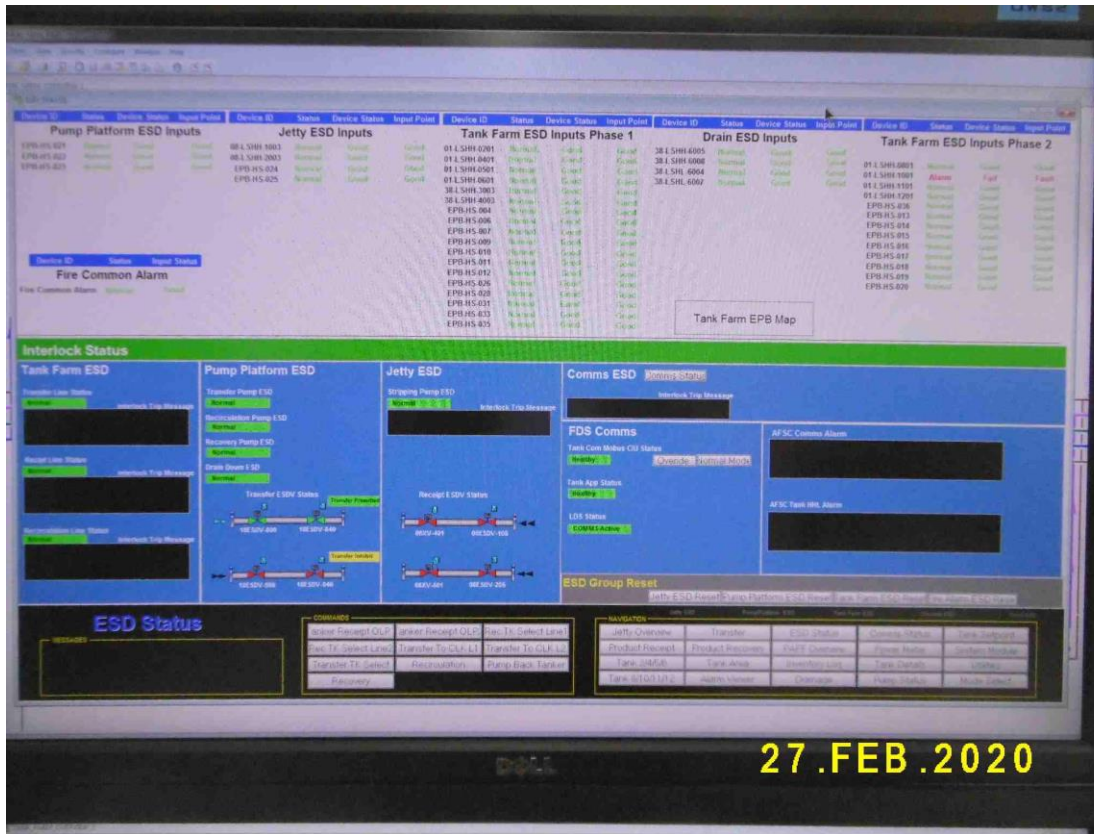

(31) The ESD regular testing as shown in SCADA System

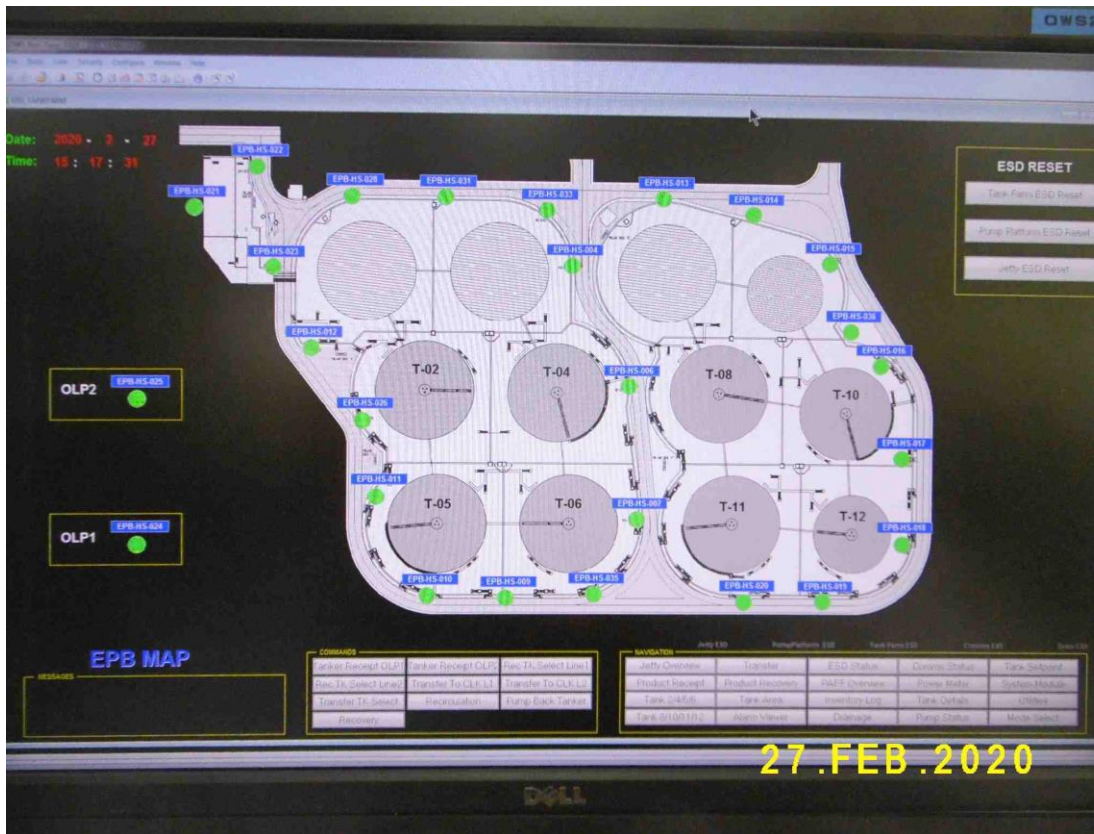

(32) The ESD regular testing as shown in SCADA System

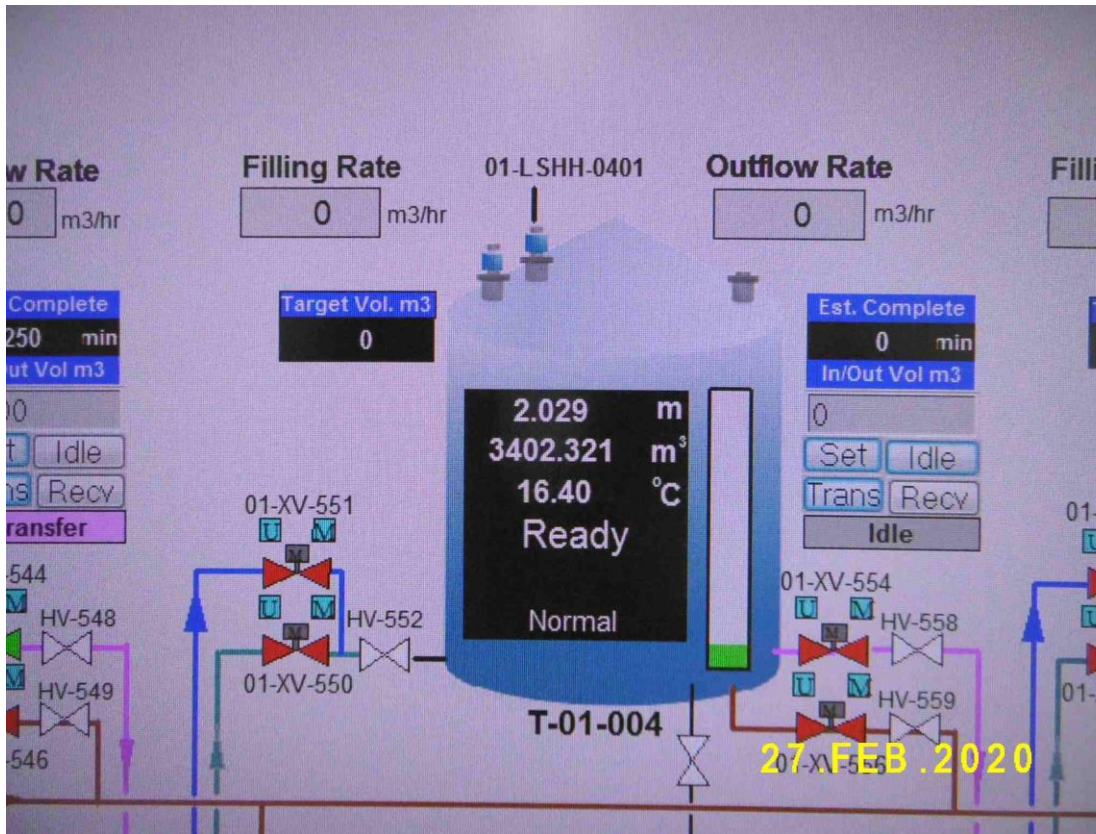

(33) The ESD test signal as shown in SCADA System

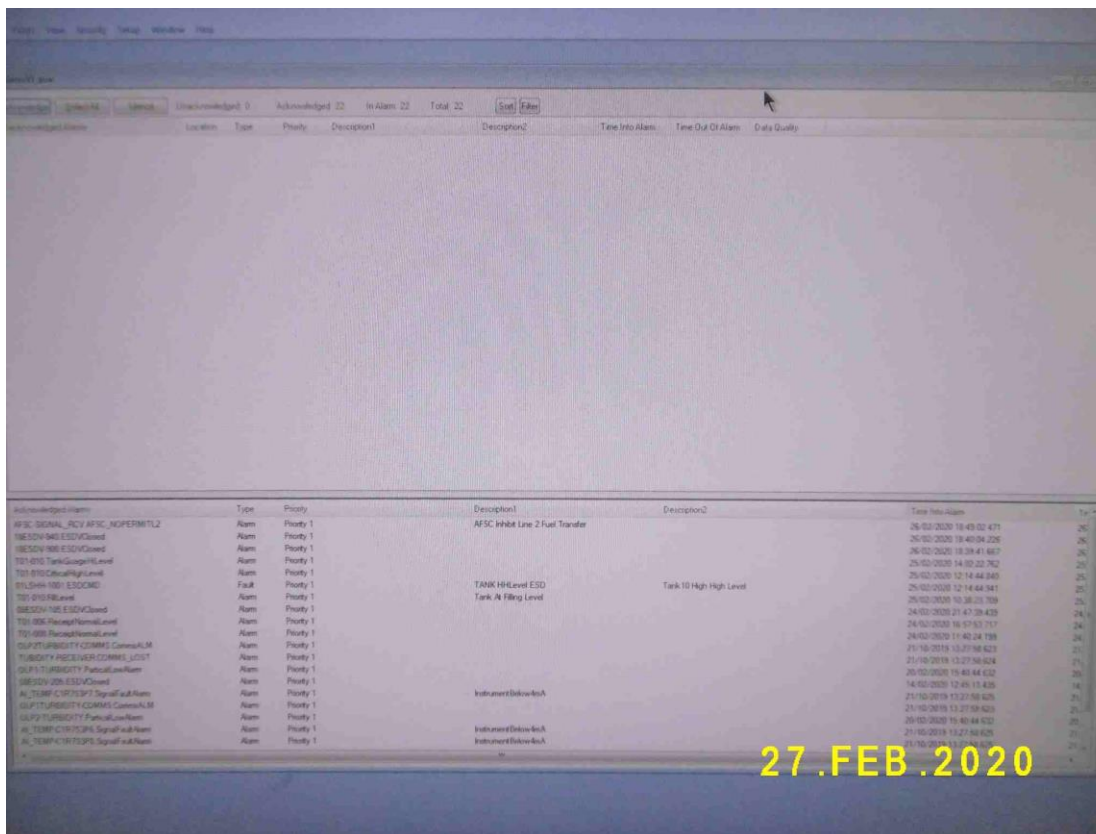

(34) Once the system received ESD test signal, the valves will be closed automatically and shut down the operation as shown in SCADA System

PAFF Emergency Shutdown Devices (ESD) Testing Report

Pump Platform ESD Inputs			Tank Farm ESD Inputs Phase 1A			Tank Farm ESD Inputs Phase 1B		
Device ID	Task	Condition	Device ID	Task	Condition	Device ID	Task	Condition
EPB-HS-021	C/R	N/F	38-LSHH-3003	C/R	N/F	EPB-HS-036	C/R	N/F
EPB-HS-022	C/R	N/F	38-LSHH-4003	C/R	N/F	EPB-HS-013	C/R	N/F
EPB-HS-023	C/R	N/F	EPB-HS-004	C/R	N/F	EPB-HS-014	C/R	N/F
			EPB-HS-006	C/R	N/F	EPB-HS-015	C/R	N/F
			EPB-HS-007	C/R	N/F	EPB-HS-016	C/R	N/F
			EPB-HS-009	C/R	N/F	EPB-HS-017	C/R	N/F
			EPB-HS-010	C/R	N/F	EPB-HS-018	C/R	N/F
			EPB-HS-011	C/R	N/F	EPB-HS-019	C/R	N/F
			EPB-HS-012	C/R	N/F	EPB-HS-020	C/R	N/F
			EPB-HS-026	C/R	N/F			
			EPB-HS-028	C/R	N/F			
			EPB-HS-031	C/R	N/F			
			EPB-HS-033	C/R	N/F			
			EPB-HS-035	C/R	N/F			

Jetty ESD Inputs		
Device ID	Task	Condition
08-LSHH-1003	C/R	N/F
08-LSHH-2003	C/R	N/F
EPB-HS-024	C/R	N/F
EPB-HS-025	C/R	N/F

Status Definitions : C = Check, R = Repair/Replace, N = Normal, F = Failure

Company Name: ECO Aviation Fuel Services Limited Location: Permanent Aviation Fuel Facility

Test Performed: Ho KA Lung Signature: 

Date: 27-2-2020

(35) Record for regular testing performed on ESD device



(36) Fenders are installed at sea side of the jetty



(37) Fenders are installed at sea side of the jetty



(38) Fenders are installed at shore side of the jetty



(39) Slop collection utilities are used for coupling and de-coupling of the loading arms

Appendix 4 - Seabed Level Survey Result

John Barrett & Associates Ltd.
Authorised Land Surveyors



Land – Hydrographic – Laser Scanning

Unit E6
7/F Wah Lok Industrial Centre
31-35 Shan Mei Street
Sha Tin, NT
Hong Kong

Tel: 2358 3452
Fax: 23583452
E-mail: enquiries@jba-surveys.com
www.jba-surveys.com

Aviation Fuel Facility Submarine Pipelines Report for Hydrographic Survey

The Project

The Aviation Fuel Facility offshore facilities include twin submarine pipelines running from Tap Shek Kok to Sha Chau and from Tap Shek Kok to the nearby off-loading jetty. The pipelines are protected by a minimum of 3 metres of rockfill cover.

Scope of Works

The objective of the hydrographic surveys was to determine the condition of the rockfill cover to the submarine pipelines and to assess any damage caused by anchoring, fishing activities or any other means. The last survey was carried out in January 2019 and the first survey was carried out in 2007 before construction works.

Methodology

A precision hydrographic multi-beam echo sounder (R2Sonic 2024 400kHz) was used to survey the seabed. The equipment was mounted on the survey vessel using an over-the-side mount fixed midships. Navigation data was input directly into the logging software from an RTK GPS mounted directly over the echo sounder.

Bathymetric surveys were carried out to show seabed levels and levels of fill over the pipelines and around the jetties. Contour plots have been produced for use in determining the extent of any siltation or damage which may have occurred.

Surveys conducted above the pipelines to give seabed levels were carried out at spacing of lines to give 100% overlap in an area extending 50m each side of the pipe centre-lines. Check lines were also run perpendicular to the direction of the pipe routes. Maximum vessel speed was 5 knots and soundings were recorded at each of 256 beams. A total of approximately 10 million soundings were recorded.

Bar checks were conducted before and after each survey to determine the Velocity of Sound and the Transducer Draft. The correction data from the Bar Checks were input into the logging software before the commencement of each survey.

High frequency data (400kHz) from the echo sounder was used to determine the seabed levels.

John Barrett MNZIS MHKIS ALS

Robert Schermuly MRICS MHKIS RPS(LS)

Survey Periods

The survey was carried out on 18th January 2020.

Saturday 18th January 2020

Winds: Easterly force 3

Sea-State: Calm

Equipment

R2Sonic 2024 Multi-Beam Echo Sounder

Qinsy Navigation and Surveying Software

Coda S185R+ RTK GPS System

InRoads SelectCAD Software

AutoCad Software

Vessel

A motorized catamaran was used for the surveys. The vessel was boarded at 8am at Marina Gardens Tuen Mun. The equipment was installed and checked on site. The boat driver was experienced in hydrographic surveying works and was familiar with the Qinsy navigation user interface.

Personnel

All works were carried out by experienced and qualified personnel (1 surveyor & 1 technician).

Safety

Before work each day the safety equipment on board the boat was checked. This equipment included life-jackets, life-buoys, whistles and lights. A safety talk was conducted prior to commencement of the works.

John Barrett MNZIS MHKIS ALS

Robert Schermuly MRICS MHKIS RPS(LS)

Tides

Real-time data from the Government operated tide gauge at Chek Lap Kok was used to determine water levels. The tide data was recorded as follows:

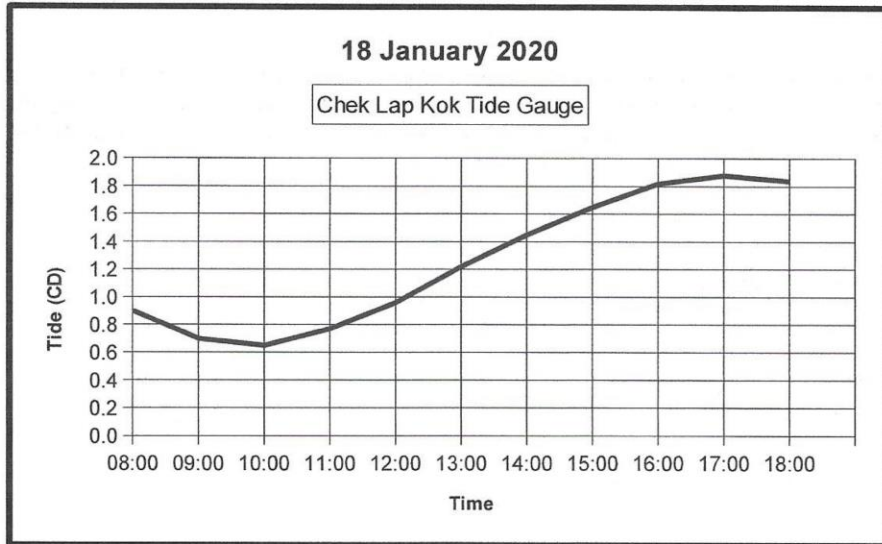

Deliverables

A report in DWG and PDF formats and endorsed by a Chartered Surveyor:

Report

- Seabed bathymetric data with soundings shown at a 25m grid and contours at 1m intervals
- Long section showing the original seabed profile (2007), the current seabed profile and the as-laid position of the pipes
- Cross-sections at 50m intervals showing the original seabed profile (2007), the current seabed profile and the as-laid position of the pipes
- Written survey summary in PDF format

John Barrett MNZIS MHKIS ALS

Robert Schermuly MRICS MHKIS RPS(LS)

Results & Conclusions

The survey results have been plotted in a manner to be directly comparable with previous survey data, specifically the initial survey of the seabed carried out before commencement of construction works for the installation of the submarine pipelines in 2007.

The results, shown as contour plots, cross-sections and long-sections do not show any evidence of damage or major disturbance to the rockfill protection layer covering the pipelines. The current seabed bathymetry is similar to the original seabed profile (2007) and also to the last survey carried out in 2019.

END OF REPORT

Signed:

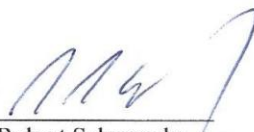
Robert Schermuly
MRICS MHKIS RPS(LS)

John Barrett MNZIS MHKIS ALS

Robert Schermuly MRICS MHKIS RPS(LS)

Appendix 5 – Drawings

List of Drawings

PAFF/BA/02/DWG/C/1452
PAFF/BA/02/DWG/C/1481
PAFF/BA/02/DWG/C/1705
PAFF/BA/02/DWG/C/1721
PAFF/BA/02/DWG/C/1722
PAFF/BA/02/DWG/C/1723
PAFF/BA/02/DWG/C/1724
PAFF/BA/02/DWG/C/1726
PAFF/BA/02/DWG/C/1727
PAFF/BA/02/DWG/C/1728
PAFF/BA/02/DWG/C/1730
PAFF/KG/02/DWG/E/7437
PAFF/LC/01/DWG/M/0202
PAFF/LC/01/DWG/M/0203
PAFF/LC/01/DWG/M/0207
PAFF/LC/02/DWG/M/0266
PAFF/LC/02/DWG/C/0340
PAFF/LC/02/DWG/C/0551
PAFF/LC/02/DWG/M/0875
PAFF/LC/03/DWG/M/0251
PAFF/LC/04/DWG/C/0408
PAFF/MA/03/DWG/C/2807
PAFF/MA/03/DWG/C/2808
PAFF/RJ/02/DWG/G/3015(EX)