

MTR Corporation Limited

South Island Line (East)

Monthly EM&A Report No. 28

November 2013

Verified by:

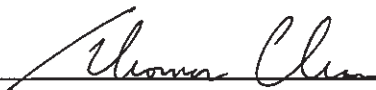

Thomas Chan

Independent Environmental Checker

Date:



MTR Corporation Limited

South Island Line (East)

Monthly EM&A Report No. 28

November 2013

Certified by:

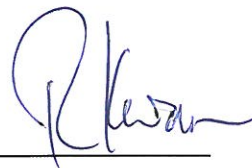

Richard Kwan

Environmental Team Leader

Date: 14 NOV 2013

EXECUTIVE SUMMARY

With the main civil works contracts of the South Island Line (East) (SIL(E)) Project awarded in May 2011, the commencement date of construction of the Project was on 25 June 2011. The Environmental Monitoring and Audit (EM&A) programme of the Project also commenced on 25 June 2011. This is the twenty-eighth Monthly EM&A Report for SIL(E) Project. The Report presents the results of EM&A works undertaken during the period of 1 October to 31 October 2013. The major construction activities in the reporting period included piling, excavation, slope stabilization works, shaft excavations, viaduct segments erection, tunnel excavation as well as construction of stations and depot.

Impact monitoring for air quality, noise and water were conducted in the reporting period. No exceedance was found and there was no breach of Action / Limit Levels for air quality. No exceedance in noise monitoring parameters recorded in the reporting period. However, exceedance in noise level against Limit Level was recorded at a complainant apartment of South Horizons Block 25 during the ad-hoc noise measurement on 17 Oct 2013.

Exceedances in DO against Action/ Limit Levels were recorded and the exceedances were considered not related to the project works.

One public complaint referred by EPD was received in the reporting month.

No notification of summon or prosecution related to the environmental issue was received in the reporting period.

Regular site inspections were conducted by the Environmental Team (ET) to check the implementation of environmental mitigation measures. No non-conformance to the environmental requirements was identified in the reporting period.

Future key issues envisaged in the coming month include noise and dust emission from site works. The ET will continue the implementation of the EM&A programme in accordance to the EM&A Manual.

EXECUTIVE SUMMARY

1 INTRODUCTION

- 1.1 Project Background**
- 1.2 Project Programme**
- 1.3 Coverage of the EM&A Report**

2 PROJECT INFORMATION

- 2.1 Project Organization and Management Structure**
- 2.2 Construction Activities in the Reporting Month**
- 2.3 Construction Activities for the Coming Month**
- 2.4 Project Areas and Environmental Monitoring Locations**
- 2.5 Summary of EM&A Requirements**

3 IMPACT MONITORING

- 3.1 Air Quality**
- 3.2 Noise**
- 3.3 Water Quality**
- 3.4 Action taken in Event of Exceedance**

4 LANDSCAPE AND VISUAL

- 4.1 EM&A Requirements**
- 4.2 Site Audit Results**

5 ECOLOGY

- 5.1 EM&A Requirements**
- 5.2 Site Audit Results**

6 WASTE MANAGEMENT

7 RECORD OF ENVIRONMENTAL COMPLAINTS

8 RECORD OF NON- COMPLIANCES

9 RECORD OF NOTIFICATION OF SUMMONS AND SUCCESSFUL PROSECUTIONS

10 STATUS OF STATUTORY SUBMISSIONS

- 10.1 Submissions required under Environmental Permit**
- 10.2 Statutory Permits and Licenses**

11 SITE INSPECTIONS

- 11.1 Implementation of Environmental Mitigation Measures**
- 11.2 Observations**
- 11.3 Solid and Liquid Waste Management Status**
- 11.4 Other Notable Events**

12 FUTURE KEY ISSUES

13 CONCLUSIONS

List of Figures

- Figures 1 to 2 Works Areas of the Project
- Figures 3 to 6 Location of Construction Air Quality Monitoring Stations
- Figures 7 to 8 Location of Construction Noise Monitoring Stations
- Figures 9 Location of Water Quality Monitoring Stations
- Figures 10 Air Quality and Noise Monitoring Locations for Telegraph Bay Barging Point

List of Appendices

- Appendix A1 *Project Organization*
- Appendix A2 *Contact List of Key Personnel of the Project*
- Appendix B1 *Action and Limit Levels for Construction Noise and Air Quality*
- Appendix B2 *Action and Limit Levels for Water Quality*
- Appendix C *Calibration Details*
- Appendix D *Graphical Plots of Air Quality, Noise & Water Quality Impact Monitoring and Monitoring Results for Water Quality*
- Appendix E *Review of Exceedance in Environmental Monitoring*
- Appendix F *Implementation of Environmental Mitigation Measures*
- Appendix G *Summary of Qualitative Risk Assessment Review for Rearrangement of Explosive Delivery for Excavation of Lei Tung Station Entrance B Adit*

1 INTRODUCTION

1.1 Project Background

The South Island Line (East) (SIL(E)) of 7.0km approximately is a new medium capacity railway with stations at South Horizons (SOH), Lei Tung (LET), Wong Chuk Hang (WCH), Ocean Park (OCP) and Admiralty (ADM), comprising underground and elevated structures. A depot is required at Wong Chuk Hang to provide maintenance support for the SIL(E).

1.2 Project Programme

Main civil works contracts of the SIL(E) were awarded in May 2011. The commencement date of construction of the Project was on 25 June 2011. The construction of the Project is expected to complete in 2015.

1.3 Coverage of EM&A Report

The Environmental Monitoring and Audit (EM&A) programme of the Project commenced on 25 June 2011. This is the twenty-eighth Monthly Environmental Monitoring and Audit (EM&A) Report for the Project. The Report presents the results of EM&A undertaken during the period of 1 to 31 October 2013.

2 PROJECT INFORMATION

2.1 Project Organization and Management Structure

The project organization is shown in **Appendix A1**. Contacts of key personnel of the Project are shown in **Appendix A2**.

2.2 Construction Activities in the Reporting Month

Major construction activities carried out by the respective SIL(E) civil works contractors during the reporting period include:

Contract No. 901

Site	Construction Activities
Harcourt Garden	<ul style="list-style-type: none">- Excavation, blasting works at SEE shaft and station box- RC construction works at station box- Demolition of existing pier and construction of permanent support at station box- Installation of concrete drop pipes at SEE shaft- A&A works at Admiralty Station- PCWA barging point (Ramp 1)

Contract No. 902

Site	Construction Activities
Hong Kong Park Ventilation Shaft	<ul style="list-style-type: none">- Shaft excavation by blasting- Mucking out by use of rock spoil storage

Site	Construction Activities
Nam Fung Portal	<ul style="list-style-type: none"> - Construction for transition box - ELS works - Tunnel excavation by drill and blast - Construction of Ventilation Building - Trial pit excavation at Nam Fung Road for FSD water main extension
Chung Hom Shan Magazine	<ul style="list-style-type: none"> - Operation of Magazine
Telegraph Bay Barging Point	<ul style="list-style-type: none"> - Operation of the Barging Point

Contract No. 903

Site	Construction Activities
Zone B (Ex-Canadian Site to OCP Station)	<ul style="list-style-type: none"> - Segment Remediation
Site Office and OCP Station	<ul style="list-style-type: none"> - Steel Roof Canopy Installation
Zone C (OCP Station to WCH Station)	<ul style="list-style-type: none"> - Insitu bridge, stitch & stressing (C8-C15) - Segment Erection Stitch , Stressing (C3-C5, C5N – C8N, C5S – C11S) - Plinth construction (C8-WCH)
WCH Station	<ul style="list-style-type: none"> - Station Roof Column, Slab, Beam (GL0-5 , 10-20,) - ABWF works - Entrance A Internal Wall and External Wall Construction - Entrance A Permanent Hanger Construction - Entrance B Pile Caps (G3-G5)
Zone D (WCH Station to WCH nullah)	<ul style="list-style-type: none"> - Noise Barrier Installation (D4-D18) - Pier construction (D1-D2) - Portal Construction (D1) - Segment Erection (D0-D3)
Zone E (Aberdeen Channel)	<ul style="list-style-type: none"> - Removal of cofferdam (E2) - Seawall Reinstatement (E2)

Contract No. 904

Site	Construction Activities
Ex-Harbour Mission School	<ul style="list-style-type: none"> - Excavation - Tunnel box construction - Tunnel excavation - Retaining wall construction
Lee Wing Street	<ul style="list-style-type: none"> - Drill and blast at Main Tunnel - Construction of Ventilation Building
LET Station Entrance A	<ul style="list-style-type: none"> - Adit excavation - Concreting and formwork - Building works
LET Station Entrance B	<ul style="list-style-type: none"> - Drainage Works - External lateral support - Shaft excavation by drill and blast
South Horizons	<ul style="list-style-type: none"> - Installation of pipe piles - Grouting works - Drainage works - ELS works - Station structure construction
South Horizons Plant Building	<ul style="list-style-type: none"> - Slope excavation and protection - Open blast at Yuk Kwai Shan
Project site office at Ap Lei Chau Bridge Playground	<ul style="list-style-type: none"> - Operation of project site office
Lee Wing Street Barging Point	<ul style="list-style-type: none"> - Operation of barging point - Dismantling of conveyor belt

Contract No. 908

Site	Construction Activities
WCH Depot	<ul style="list-style-type: none"> - Permanent drainage construction - Perimeter wall construction - Slab construction - Concreting

2.3 Construction Activities for the Coming Month

The scheduled major construction activities in the next reporting month are as follows:

Contract No. 901

Site	Construction Activities
Harcourt Garden	<ul style="list-style-type: none"> - Excavation, blasting works at SEE shaft and station box - RC construction works at station box - Installation of rails for skip hoist and silo - A&A works at Admiralty Station - PCWA barging point (Ramp 1)

Contract No. 902

Site	Construction Activities
Hong Kong Park Ventilation Shaft	<ul style="list-style-type: none"> - Shaft excavation by blasting - Mucking out by use of rock spoil storage
Nam Fung Portal	<ul style="list-style-type: none"> - Construction for transition box - ELS works - Tunnel excavation by drill and blast - Construction of Ventilation Building - Trial pit excavation at Nam Fung Road for FSD water main extension
Chung Hom Shan Magazine	<ul style="list-style-type: none"> - Operation of Magazine
Telegraph Bay Barging Point	<ul style="list-style-type: none"> - Operation of the Barging Point

Contract No. 903

Site	Construction Activities
Zone B (Ex-Canadian Site to OCP Station)	<ul style="list-style-type: none"> - Segment Remediation
Site Office and OCP Station	<ul style="list-style-type: none"> - Steel Roof Canopy Installation - Roof Waterproofing & Roof Tile
Zone C (OCP Station to WCH Station)	<ul style="list-style-type: none"> - Insitu bridge, stitch & stressing (C8-C15) - Segment Erection Stitch , Stressing (C3-C5, C5N – C8N, C5S – C11S) - Plinth Construction (C6-C8) - Noise Barrier Installation (C0-C5)
WCH Station	<ul style="list-style-type: none"> - Station Roof Column, Slab, Beam (GL0-5) - ABWF works - Entrance A Backfilling cable trench - Entrance A Construction of ground slab (GL9-15) - Entrance B Pile Caps (G3-G5)

Site	Construction Activities
Zone D (WCH Station to WCH nullah)	<ul style="list-style-type: none"> - Portal Construction (D1) - Pier construction (D1) - Segment Erection (D0 – D3) - Noise Barrier Installation (D4 – D18) - Pedestrian Link Bridge Mini Piles - Tong Bin Lane Retaining wall Construction
Zone E (Aberdeen Channel)	<ul style="list-style-type: none"> - Removal of cofferdam at E2 - Seawall Reinstatement (E2 & E3))

Contract No. 904

Site	Construction Activities
Ex-Harbour Mission School	<ul style="list-style-type: none"> - Excavation - Tunnel box construction - Tunnel excavation - Retaining wall construction
Lee Wing Street	<ul style="list-style-type: none"> - Drill and blast at Main Tunnel - Construction of Ventilation Building
LET Station Entrance A	<ul style="list-style-type: none"> - Adit excavation - Concreting and formwork - Building works
LET Station Entrance B	<ul style="list-style-type: none"> - Drainage Works - External lateral support - Shaft excavation by drill and blast
South Horizons	<ul style="list-style-type: none"> - Installation of pipe piles - Grouting works - Drainage works - ELS works - Station structure construction
South Horizons Plant Building	<ul style="list-style-type: none"> - Slope excavation and protection - Open blast at Yuk Kwai Shan
Project site office at Ap Lei Chau Bridge Playground	<ul style="list-style-type: none"> - Operation of project site office
Lee Wing Street Barging Point	<ul style="list-style-type: none"> - Operation of barging point - Dismantling of conveyor belt

Contract No. 908

Site	Construction Activities
WCH Depot	<ul style="list-style-type: none"> - Permanent drainage construction - Perimeter wall construction - Slab construction - Concreting

2.4 Project Areas and Environmental Monitoring Locations

The works areas of the Project are shown in **Figures 1 and 2**. Operation of Telegraph Bay barging point has commenced since 24 September 2012. Impact dust and noise monitoring has been started at designated monitoring locations during operation of the Telegraph Bay barging point in accordance with the Construction and Demolitions Materials Management Plan (C&DMMP) approved under EP.

The locations of environmental monitoring stations are shown in **Figures 3 to 10**. Tables 1 and 2 below shows the details of the active monitoring stations as reported in Sections 3.1 to 3.3 below.

Table 1 Summary of impact dust and noise monitoring stations

ID	Monitoring Station
Dust	
CD1	Wong Chuk Hang San Wai
CD2	Police College – Police Quarters
CD3	San Wui Commercial Society of HK Chan Pak Sha School
CD4	Shan On House
CD5*	South Horizons Phase IV – Block 25
DTB1	Site boundary of Telegraph Bay barging point
Noise	
CN1	San Wui Commercial Society of HK Chan Pak Sha School (Educational Institution)
CN2	Holy Spirit Seminary (Education Institution)
CN3*	Shun Fung Building (Residential)
CN4*	South Horizons Phase IV – Block 25 Dover Court (Residential)
CN5*	TWGHs Jockey Club Rehabilitation Complex Block A (Convalescent Home)
NTB1	Outside Aegean Terrace

* Location updated due to site access problem, or as per the agreement with the premises landlord, and agreed with EPD

Table 2 Summary of impact water quality monitoring stations

ID	Location	Easting	Northing
WM1	Aberdeen West Typhoon Shelter	833953	811923
WM2	Wong Chuk Hang Nullah	834547	811966
WM3	WSD Brick Hill Seawater Intake	834896	811567
WM4	Aberdeen South Typhoon Shelter	834761	811292
CS1	Control Station	832689	811967
CS2	Control Station	834852	810689

2.5 *Summary of EM&A Requirements*

The EM&A programme as specified in the EM&A Manual has been implemented during the construction stage.

In the reporting period, impact monitoring of LAeq, 30min noise levels was carried out at the monitoring locations as shown in Table 1 once every week. Also, 24-hour TSP monitoring was conducted at the monitoring locations as shown in Table 1 once every week. Impact water quality monitoring at Aberdeen Channel was also undertaken at the monitoring locations as shown in Table 2 three working days per week at mid-ebb and mid-flood tides during the course of marine based works.

Action and Limit Levels for construction noise and air quality as well as water quality are shown in **Appendices B1 and B2** respectively. Should non-compliance of the criteria occurs, action in accordance with the respective Event and Action Plans for construction noise, air quality and water quality in the EM&A Manual / Updated EM&A Manual should be carried out.

Monthly monitoring of the ardeid night roost location beside Wong Chuk Hang Nullah by qualified ecologist was also conducted.

In addition, regular site inspection to active works areas was carried out. The areas of inspection included the pollution control and mitigation measures within the site. Waste management and landscape and visual aspects were covered.

3 **IMPACT MONITORING**

3.1 *Air Quality*

Monitoring Methodology

24-hour TSP samples were collected by High Volume Sampler (Graseby-Andersen) following United States Environmental Protection Agency regulations. The sampling procedure follows to that described in the App. B of Pt 50 in 40CFR Ch.1 (U.S. Environmental Protection Agency). TSP is sampled by drawing air through a conditioned, pre-weighed filter paper inside the high volume sampler at a controlled rate. After 24-hour sampling, the filter paper with retained particles is collected and returned to the laboratory for drying in a desiccators followed by weighing. TSP levels are calculated from the ratio of the mass of particulate retained on the filter paper to the total volume of air sampled.

The samplers have been properly maintained. Prior to dust monitoring commencing, appropriate checks have been made to ensure that all equipment and necessary power supply are in good working condition.

Calibration Requirements

The flow rate of the high volume sampler with mass flow controller is calibrated using an orifice calibrator. Initial calibration (five points) is conducted upon installation and prior to commissioning. Calibration will be carried out every six months. The calibration records are shown in **Appendix C**.

Monitoring Results

To examine the construction dust levels, 24-hour TSP monitoring was undertaken at the monitoring locations as shown in Table 1 according to the EM&A Manual.

Monitoring results are presented in the following table (see **Appendix D** for graphical plots). The 24-hour TSP levels were within the Action Level. No exceedance was found. This indicates that the construction activities did not have a noticeable adverse effect on the general air quality of the project areas.

Date	TSP ($\mu\text{g}/\text{m}^3$)	Action Level ($\mu\text{g}/\text{m}^3$)	Limit Level ($\mu\text{g}/\text{m}^3$)	Compliance (Yes/No)	Weather Condition
CD1 Wong Chuk Hang San Wai					
2-Oct	79.7	173	260	Yes	Fine
9-Oct	84.5	173	260	Yes	Cloudy
16-Oct	88.3	173	260	Yes	Fine
23-Oct	81.3	173	260	Yes	Fine
CD2 Police College – Police Quarters					
3-Oct	120.7	184	260	Yes	Cloudy
10-Oct	49.6	184	260	Yes	Cloudy
17-Oct	59.2	184	260	Yes	Cloudy
21-Oct	96.6	184	260	Yes	Fine
29-Oct	120.6	184	260	Yes	Fine
CD3 San Wui Commercial Society of HK Chan Pak Sha School					
3-Oct	110.9	169	260	Yes	Cloudy
10-Oct	41.0	169	260	Yes	Cloudy
17-Oct	91.9	169	260	Yes	Cloudy
21-Oct	86.5	169	260	Yes	Fine
29-Oct	150.8	169	260	Yes	Fine
CD4 Shan On House					
3-Oct	101.7	176	260	Yes	Cloudy
10-Oct	52.6	176	260	Yes	Cloudy
18-Oct	70.5	176	260	Yes	Fine
25-Oct	74.5	176	260	Yes	Fine
31-Oct	74.8	176	260	Yes	Fine
CD5 South Horizons Phase IV – Block 25					
3-Oct	113.9	169	260	Yes	Cloudy
10-Oct	62.2	169	260	Yes	Cloudy
18-Oct	80.7	169	260	Yes	Fine
25-Oct	87.4	169	260	Yes	Fine
31-Oct	74.6	169	260	Yes	Fine
DTB1 Site boundary of Telegraph Bay barging point					
3-Oct	142.2	156	260	Yes	Cloudy
10-Oct	102.6	156	260	Yes	Cloudy
18-Oct	119.6	156	260	Yes	Fine
25-Oct	129.0	156	260	Yes	Fine
31-Oct	110.3	156	260	Yes	Fine

Note: Please refer to Figures 3 to 6 and 10 for the location of construction air quality monitoring stations

3.2 Noise

Monitoring Methodology

Monitoring was conducted using B&K sound analysis equipment – B&K SLM 2250. Microphone was extended 1 meter from building facades and oriented towards the works area.

Calibration Requirements

B&K 2250 sound level meters and B&K 4231 calibrators which complied with the International Electrotechnical Commission Publication 651:1979 (Type 1) and 804:1985 (Type 1), specification as referred to in the Technical Memoranda to the NCO were used for the impact monitoring. The sound level meters and calibrators are verified by the certified laboratory or manufacturer once every two years to ensure they perform to the same level of accuracy as stated in the manufacturer's specifications. The calibration records are shown in **Appendix C**.

Immediately prior to and following each set of measurements at any NSR, the accuracy of the sound level meter was checked using an acoustic calibrator generating a known sound pressure level at a known frequency. If the calibration levels before and after the measurement differs by more than 1.0dB, the measurement shall be repeated to obtain a reliable result (note: maximum deviation during this initial baseline monitoring period was 0.3dB). Periods of prolonged or repeated overloading of the sound level meter detector were avoided by setting the meter with adequate headroom prior to commencing measurements. Measurements were recorded to the nearest 0.1 dB, with values of 0.05 being rounded up.

Monitoring Results

Impact monitoring of LAeq, 30min noise levels was undertaken to measure construction noise levels in accordance with the Updated EM&A Manual at the monitoring locations as shown in Table 1. The monitoring was conducted during the course of construction works, please refer to S2.2 for major construction activities of the respective SIL(E) civil works contracts in the reporting month. Weather conditions throughout the monitoring period were mild with light wind of not exceeding 2-3m/s on average.

Noise monitoring results are presented in the following table and graphical plot for are presented in **Appendix D**.

Date	Time	LAeq (dBA)	Limit Level (dBA)	Compliance (Yes/No)	Weather Condition
CN1 San Wui Commercial Society of HK Chan Pak Sha School					
8-Oct	13:45	70.0	70 [#]	Yes	Fine, wind <5m/s
15-Oct	13:58	67.7	70 [#]	Yes	Fine, wind <5m/s
22-Oct	14:20	69.2	70 [#]	Yes	Fine, wind <5m/s
30-Oct	14:23	68.8	70 [#]	Yes	Fine, wind <5m/s
CN2 Holy Spirit Seminary					
4-Oct	16:18	66.3	70 [#]	Yes	Cloudy, wind <5m/s
9-Oct	16:20	66.7	70 [#]	Yes	Cloudy, wind <5m/s
18-Oct	16:21	66.8	70 [#]	Yes	Fine, wind <5m/s
25-Oct	16:14	65.7	70 [#]	Yes	Fine, wind <5m/s
CN3 Shun Fung Building					
3-Oct	11:00	72.9	75 [#]	Yes	Cloudy, wind <5m/s
10-Oct	11:10	65.7	75 [#]	Yes	Cloudy, wind <5m/s
18-Oct	11:15	70.5	75 [#]	Yes	Fine, wind <5m/s
25-Oct	15:15	71.5	75 [#]	Yes	Fine, wind <5m/s
31-Oct	11:05	68.9	75 [#]	Yes	Fine, wind <5m/s
CN4 South Horizons Phase IV – Block 25 Dover Court					
3-Oct	15:00	74.8	75 [#]	Yes	Cloudy, wind <5m/s
11-Oct	16:30	74.1	75 [#]	Yes	Fine, wind <5m/s
15-Oct	14:00	74.0	75 [#]	Yes	Fine, wind <5m/s
24-Oct	10:00	73.1	75 [#]	Yes	Fine, wind <5m/s
31-Oct	14:00	71.8	75 [#]	Yes	Fine, wind <5m/s

Date	Time	LAeq (dBA)	Limit Level (dBA)	Compliance (Yes/No)	Weather Condition
CN5 TWGHs Jockey Club Rehabilitation Complex Block A					
4-Oct	15:07	63.7	75	Yes	Cloudy, wind <5m/s
9-Oct	15:31	63.4	75	Yes	Cloudy, wind <5m/s
18-Oct	15:35	64.6	75	Yes	Fine, wind <5m/s
25-Oct	15:42	65.3	75	Yes	Fine , wind <5m/s
NTB1 Outside Aegean Terrace					
3-Oct	9:50	56.8	75	Yes	Cloudy, wind <5m/s
10-Oct	10:00	60.7	75	Yes	Cloudy, wind <5m/s
18-Oct	10:20	56.9	75	Yes	Fine, wind <5m/s
25-Oct	13:50	55.9	75	Yes	Fine, wind <5m/s
31-Oct	10:00	59.3	75	Yes	Fine, wind <5m/s

(#) Or updated prediction of noise levels as contained in Construction Noise Mitigation Measures Plan

3.3 Water Quality

Monitoring Methodology

Water quality was monitored in terms of the following parameters: Dissolved Oxygen (DO, mg/L) and Dissolved Oxygen Saturation (DO %), temperature (°C), pH, turbidity (NTU), salinity (ppt), suspended solids (mg/L) and water depth (m). All parameters were measured in-situ whereas SS shall be determined by the laboratory.

Water samples were taken with a water sampler, consisting of a transparent PVC cylinder of 2 litres that can be effectively sealed with cups at both ends. The water sampler has a positive latch system to keep it open and prevent premature closure until released by a messenger when the sampler arrives is at the pre-determined depth.

Measurement was taken at 3 water depths, namely, 1m below water surface, mid-depth and 1m above sea bed, except where the water depth less than 6m, the mid-depth station may be omitted. Should the water depth be less than 3m, only the mid-depth station was monitored.

Duplicate in-situ measurements and samples were collected and analyzed to ensure a robust statistically interpretable dataset. Where the difference in value between the first and second measurement of DO or turbidity parameters is more than 25% of the value of the first reading, the reading was discarded and further readings were taken.

Water samples for all monitoring parameters were collected, stored, preserved and analyzed according to APHA Standard Methods. Water samples were stored in high-density polythene bottles, packed in ice and delivered to the laboratory of ETS-Testconsult Limited, a HOKLAS accredited laboratory.

The SS determination work was start within 24 hours after collection of the water samples. The SS analyses followed the standard method APHA 2540D with a detection limit of 1mg/L as described in APHA Standard Methods for the Examination of Water and Wastewater.

A digital depth detector was employed to determine the water depth at selected stations when flows permit.

Calibration Requirements

On-site monitoring equipment namely the salinity meter, pH meter, turbidity meter, dissolved oxygen meter and temperature meter were calibrated before use. The methodologies for the calibration are referred to the instruction manual provided by the manufactures respectively. The calibration records are shown in **Appendix C**. Response of

sensors and electrodes was checked with certified standard solutions before each use.

Monitoring Results

Impact water quality monitoring was undertaken in accordance with the EM&A Manual at the six designated monitoring locations at Aberdeen Channel as shown in Table 2 during the course of marine based works in the reporting period. Monitoring locations WM1-WM4 cover the Aberdeen West Typhoon Shelter, Wong Chuk Hang Nullah, WSD Brick Hill Seawater intake and Aberdeen South Typhoon Shelter while monitoring location CS1 and CS2 are the control stations. CS1 and CS2 are the upstream control stations for the Ebb and Flood tide conditions respectively.

Monitoring results and graphical plots are presented in **Appendix D**.

3.4 Action taken in Event of Exceedance

There was no exceedance in air quality monitoring parameters recorded in the reporting period, therefore no action was taken.

There was no exceedance in noise monitoring parameters recorded in the reporting period. However, exceedance in noise level against Limit Level was recorded at a complainant apartment of South Horizons Block 25 on 17 Oct 2013. Details are mentioned in S7.

Exceedances in DO against Action/ Limit Levels were recorded at the monitoring stations WM1, WM2, WM3 & WM4 on 2, 4, 7, 11, 15, 17, 19, 21, 23, 25, 28 and 30 October 2013 in the reporting month. The exceedances were considered not related to the project works. Please refer to **Appendix E** for the review of exceedance in water quality monitoring.

4 LANDSCAPE AND VISUAL

4.1 EM&A Requirements

The landscape and visual mitigation measures undertaken by the contractors during the construction phase have been audited on a regular basis according to the EM&A Manual.

4.2 Site Audit Results

Regular inspections and audits were conducted by the Certified Arborist as required by the EP and it was found that the transplanting works and the tree protection works being carried out by the civil works and transplantation contractors were in accordance with the EP/ EIA. Necessary tree removal or protection works were being carried out in accordance with the EP/ EIA or approved Tree Removal Application. No non compliance was identified in the reporting period.

Retained Trees

No immediate hazards were noted for any of the OVTs during reporting period. Health conditions of the two retained and pruned trees, *Ficus elastica*, located at Wong Chuk Hang San Wai have been monitored. The contractor had enhanced the tree protection zone and was reminded to properly maintain the protection zone.

Transplanted Tree

Total of 456 trees of the SIL(E) had been transplanted as of the reporting month. They were mostly transplanted to the holding nursery at Chung Hom Shan and Kellett Bay, permanent receptor sites such as Lok Ma Chau or in-situ under project areas.

5 *ECOLOGY*

5.1 *EM&A Requirements*

Auditing of the ecological mitigation measures during the construction phase have been carried out on a regular basis according to the EM&A Manual.

5.2 *Site Audit Results*

Ardeid Night Roost

Regular inspections to the works areas around the ardeid night roost have been conducted by the ecologist to check the ecological mitigation measures with regard to the ardeids at Wong Chuk Hang Nullah. Inspections of the ardeid night roost have been made for any active ardeid nests. Whilst ardeids have never been recorded nesting at this site, precautionary checks for active nests or signs of breeding have been made.

Monthly monitoring of the ardeid night roost location was also conducted by the ecologist from a vantage point, at Ap Lei Chau Bridge (on the Wong Chuk Hang side), with an unobstructed view over the area. According to the EM&A Manual, the surveys will commence approximately one hour before sunset and continue for 20 minutes after sunset, or until nightfall, which comes sooner. Any aggregation of night roosting ardeid in the degraded woodland or adjacent area have been located and counted.

During the reporting month, the monthly night ardeid survey was conducted on 9th October 2013 commenced at 1740hr. No ardeids was observed roosted at this location.

Nevertheless, the roosting site at Wong Chuk Hang shall be maintained in good condition, and proper mitigation measures will be kept for the tree protection within the site. Proper tree protection measures have been implemented as far as practicable by the contractor to the current and potential roost trees retained on site.

Plant Species of Conservation Interest

Detailed field survey led by the ecologist was undertaken in March and early May 2011 to ascertain the presence of any rare or protected flora species to be affected. The surveys covered all above ground works areas of the project and the survey results were presented in the Detailed Transplanting Baseline Survey Report submitted under the Environmental Permit.

As in the Detailed Transplanting Baseline Survey Report, two plant species of conservation interest recorded in the degraded woodland to the south of Wong Chuk Hang Nullah, namely herb *Houttuynia cordata* and tree *Aquilaria sinensis* (including seedlings), and planted young tree *Ailanthus fordii* (including seedlings) recorded in a plantation area near Hong Kong Park will be influenced by the project works. Other plant species of conservation interest identified will be protected on-site and appropriate tree protection measures would be established if needed. Health condition of the most plant species protected in-situ generally remained unchanged as in the Detailed Transplanting Baseline Survey Report. However, it is noted that health condition of *Ailanthus fordii* (tree no. OCP-T2231), which is outside the active works area at Wong Chuk Hang San Wai, was found to remain in generally fair physiologically condition. Two *Aquilaria sinensis*, which are located outside the active works area to the north of Nam Fung Road, were also found in very poor health condition and suspected to be dead specimens.

Regular monitoring on the transplanted *H. cordata* and *A. fordii* within the works area has been conducted. The transplanted *H. cordata* and *A. fordii* were in fair health condition and protection fences have been maintained around the receptor sites. Individuals of rare herb *H. cordata* were observed during the reporting month, about 15% of the protected area

was covered by the rare herbs. Condition of one transplanted young seedling *A. fordii* has grown satisfactorily with new leaves developed from the apical bud. while the retained tree T3 has remained in fair condition. The health condition of the two transplanted *Aquilaria sinensis* was declining. WCH-T792 and WCH-T873 have been a standing dead wood for several months, with fungal fruiting bodies developed along the lower trunk, In order to relieve safety hazard, removal of the two specimens will be carried out accordingly.

According to the Transplanting Proposal for *H. cordata* submitted in Sep 2011, post transplantation maintenance period were undertaken throughout the 12-month and is completed.

6 WASTE MANAGEMENT

Mitigation measures on waste management have been implemented in accordance with the site waste management plans for the respective civil works contracts. The C&D materials have been disposed of at the public fill reception facilities while C&D wastes have been disposed of at the landfills. Quantities of wastes disposed in the reporting period are summarized in the following table:

Contract No	Inert C&D Materials Disposed at Public Fill (m ³)	Inert C&D Materials Reused (m ³)	Non-inert Waste Disposed at Landfill (m ³)	Chemical Waste to Designated Treatment Facility (litre/ kg)
Reporting Period: October 2013				
Contract 901	5,444	9,257	58	1,200
Contract 902	4,320	18,498	162	1,400
Contract 903	829	536	163	350
Contract 904	1,205	13,376	14	600
Contract 908	2,007	0	1,500	0

7 RECORD OF ENVIRONMENTAL COMPLAINTS

There was one environmental complaint referred by EPD in the reporting period:-

1. EPD received a public complaint on 22 Oct 2013 and concerning the blasting works and noise from the construction works at around 21:30 from MTR construction site at Hong Kong Park. EPD referred the complaint information to MTR on 25 Oct 2013 for complaint investigation as per the EM&A programme. Investigation has been carried out that valid CNP has been granted for captioned site and conditions have been followed. Construction activities and blasting have already been rescheduled to minimize disturbance to the neighborhood.

Investigation report had been sent to EPD.

Regarding to the public complaint to MTR on 25 September 2013 regarding daytime noise from 904 South Horizons Plant Building site at Yuk Kwai Shan, an ad-hoc noise measurement had been carried out on 17 Oct 2013 at the complainant's apartment at Block 25 South Horizons as requested by EPD. LAeq, 30min noise level of 76.4dB(A) was recorded between 14:26 and 14:56, which exceeded the construction noise limit level of 75dB(A). Investigation and necessary remedial action have also been conducting following the procedures specified in the Event and Action plan under the Updated EM&A Manual. An immediate action was made by reducing the number of PME at the site to avoid further exceedance. The contractor was required to propose remedial measures/ action for ER, IEC and ET's review.

8 RECORD OF NON-COMPLIANCES

There was no non-compliance identified in the reporting period. Exceedances in water quality monitoring parameters against Action/ Limit Levels were recorded in the reporting month and the exceedances were considered not related to the project works. Details are mentioned in S3.4 and **Appendix E**. As per the complainant and ad-hoc noise measurement mentioned in S7, exceedance in noise level against Limit Level was recorded in the reporting month. Investigation and necessary remedial action have also been conducting following the procedures specified in the Event and Action plan under the Updated EM&A Manual. An immediate action was made by reducing the number of PME at the site to avoid further exceedance. The contractor was required to propose remedial measures/ action for ER, IEC and ET’s review.

9 RECORD OF NOTIFICATIONS OF SUMMONS AND PROSECUTIONS

No summon or prosecution related to environmental issue was received or made against the Project in the reporting period. However, a Record of Inspection (yellow form) was issued to MTR on 30 Oct 2013 by EPD for exceedance of construction noise limit level from the ad-hoc noise monitoring on 17 Oct 2013. Investigation and necessary remedial action have also been conducting following the procedures specified in the Event and Action plan under the Updated EM&A Manual. An immediate action was made by reducing the number of PME at the site to avoid further exceedance. The contractor was required to propose remedial measures/ action for ER, IEC and ET’s review.

10 STATUS OF STATUTORY SUBMISSIONS

10.1 Submissions required under Environmental Permit

A summary of the status of submissions required under the SIL(E) Environmental Permit as of 31 October 2013 is shown below:

EP Clause No.	Description of Submission	Status
1.11	Commencement date of construction	Submitted on 25 May 2011
1.14	Commencement date of operation	To be submitted no later than 2 months prior to commencement of operation of the Project
2.1 & 2.2	Employment of IEC & ET	Submitted on 6 Apr 2011
2.3	Employment of Qualified Ecologist	Submitted on 6 Apr 2011
2.4	Employment of Certified Arborist	Updated Certified Arborist submitted on 19 Aug 2013
2.5	Management organization of main construction companies	Updated main construction companies submitted on 15 Jun 2012
2.6	Construction programme & EP submission schedule	Submitted on 10 Jun 2011
2.7	Set up of Community Liaison Group	Submitted on 20 Apr 2011
2.8	Updated EM&A Manual	EP Condition fulfilled dated 13 February 2012

EP Clause No.	Description of Submission	Status
2.9	Construction Noise Mitigation Measures Plan	Updated Construction Noise Mitigation Measures Plan submitted on 11 May 2012 and EP Condition fulfilled date 22 May 2012
2.11	Construction & demolition materials management plan for barging points	Revised Construction & Demolition Materials Management Plan submitted on 12 Apr 2013 and EP Condition fulfilled on 26 Apr 2013
2.13 (a)	Ecological planting & landscape plan	EP Condition fulfilled dated 12 December 2011
2.13 (b)	As built drawings of ecological planting & landscape works	To be submitted no later than 1 month after completion of planting works (at Wong Chuk Hang nullah)
2.13 (c)	Final monitoring report of ecological planting & landscape works	To be submitted no later than 1 month after completion of the 3-year post planting care and maintenance period
2.14 (a)	Detailed transplanting baseline survey report for plant species of conservation interest	Resubmitted on 8 Sep 2011 and no further comment received
2.14 (b)	Transplantation proposal for plant species of conservation interest	H. cordata: EP Condition fulfilled dated 15 Sep 2011 Aq. sinensis: EP Condition fulfilled dated 21 Feb 2012 Ai. fordii: EP Condition fulfilled dated 18 Oct 2011
2.14 (c)	As built drawings of transplanting works for plant species of conservation interest	H. cordata: EP Condition fulfilled dated 15 Sep 2011 Aq. sinensis: EP Condition fulfilled dated 2 May 2012 Ai. fordii: EP Condition fulfilled dated 22 Dec 2011
2.15	Tree protection plan	Updated Tree protection plan submitted on 4 May 2012 and EP Condition fulfilled dated 30 May 2012
2.16(a)	Silt curtain plan	For Aberdeen Channel: EP Condition fulfilled dated 12 Aug 2011 For Telegraph Bay: EP Condition fulfilled dated 14 Dec 2011
2.17(b)	Sample test results for on-site re-use of marine sediment	EP Condition fulfilled dated 26 Apr 2013
2.17(c)	Sediment Sampling Report	To be submitted no later than 2 months after the completion of land based backfilling of the treated marine sediment

EP Clause No.	Description of Submission	Status
2.25	Operational groundborne noise review plan	To be submitted no later than 1 month after completion of corresponding parts of tunnel excavation
2.26	Operational groundborne noise mitigation measures plan	To be submitted no later than 1 month prior to installation of rail tracks.
2.27	As built drawings for operational groundborne noise mitigation measures	To be submitted no later than 1 month after completion of tracks installation
2.29	As built drawings for operational airborne noise mitigation measures on viaduct section	To be submitted no later than 1 month after completion of noise mitigation measures installation on viaduct section
2.30	Noise performance test report	To be submitted no later than 1 month prior to commencement of operation of the Project
2.31	Fixed plant noise audit report	To be submitted no later than 1 month prior to commencement of operation of the Project
2.32	Visual & landscape plan	For Site No.6 Nam Fung Portal: EP Condition fulfilled dated 25 June 2013
3.1	Environmental Monitoring and Audit Requirements	Letter submitted to EPD on 20 Aug 2013 for the extension of temporary suspension of water quality monitoring till August 2013
3.3	Baseline monitoring report	EP Condition fulfilled dated 21 February 2012
3.4	Monthly EM&A reports	Submit within 2 weeks after the end of the reporting month
4.2	Internet address of EM&A and project data	Submitted on 25 Jul 2011

10.2 Statutory Permits and Licenses

A summary of the status of all relevant environmental permit and licenses as of 31 October 2013 is shown below:

Description	Effective Date	Expiry Date
Environmental Permit for South Island Line (East) EP-407/2010/C	18/4/2013	N/A
Contract 901		
Chemical Waste Producer Licence 5213-124-K3004-01	23/5/2011	N/A
Waste Disposal (Trucks) 7012859	1/6/2011	N/A
Waste Disposal (Vessels) 7016555	7/9/2013	6/12/2013
Water Discharge Licence WT00015547-2013	26/3/2013	31/7/2016
CNP for SEE Shaft and Stationbox GW-RS1077-13	26/9/2013	25/10/2013
CNP for SEE Shaft and Stationbox (Superseded GW-RS1077-13) GW-RS1210-13	26/10/2013	24/4/2014
CNP for Large Plants Delivery GW-RS1032-13	14/9/2013	11/3/2014
CNP for Ventilation Shaft Dismantling GW-RS1037-13	16/9/2013	13/11/2013
CNP for Ventilation Shaft Dismantling (updated) GW-RS1092-13	11/10/2013	27/12/2013

Description		Effective Date	Expiry Date
CNP for A&A works at Admiralty Station	GW-RS0688-13	21/6/2013	10/12/2013
Contract 902			
Chemical Waste Producer Licence (Nam Fung)	5213-175-N2206-12	24/6/2011	N/A
Chemical Waste Producer Licence (HK Park)	5213-124-N2345-02	28/10/2011	N/A
Chemical Waste Producer Licence (Telegraph Bay)	5213-171-N2206-24	17/4/2012	N/A
Waste Disposal (Trucks)	7012912	26/5/2011	N/A
Waste Disposal (Vessels)	7015920	28/2/2013	02/6/2013
Water Discharge Licence for HK Park	WT00009688-2011	22/7/2011	31/7/2016
Water Discharge Licence for Nam Fung Path	WT00009749-2011	22/7/2011	31/7/2016
Water Discharge Licence for CHS Magazine	WT00009842-2011	11/8/2011	31/8/2016
Water Discharge Licence for Telegraph Bay Barging Point	WT00010649-2011	27/10/2011	31/10/2016
CNP for Nam Fung 24-hour Tunnel Excavation (Blast door at CH40)	GW-RS0969-13	30/8/2013	28/2/2014
CNP for HK Park 24-hour Shaft Excavation	GW-RS0747-13	6/7/2013	1/1/2014
Contract 903			
Chemical Waste Producer Licence (Ocean Park Station)	5213-175-L2174-31	14/6/2011	N/A
Chemical Waste Producer Licence (Ap Lei Bridge)	5213-175-L2174-32	30/6/2011	N/A
Chemical Waste Producer Licence (Zone D)	5213-175-L2174-33	30/6/2011	N/A
Chemical Waste Producer Licence (Nam Long Shan Sitting Out Area)	5213-175-L2174-34	30/6/2011	N/A
Chemical Waste Producer Licence (Wong Chuk Hang Station)	5213-175-L2174-35	30/6/2011	N/A
Waste Disposal	7012721	12/5/2011	N/A
Water Discharge Licence for Ap Lei Chau Bridge	WT00009838-2011	5/8/2011	31/8/2016
Water Discharge Licence for for all pier areas Zone B	WT00009931-2011	16/8/2011	31/8/2016
Water Discharge Licence for OCP station	WT00010501-2011	3/10/2011	31/10/2016
Water Discharge Licence for Zone D	WT00010319-2011	3/10/2011	31/10/2016
Water Discharge Licence for Zone C	WT00010648-2011	24/10/2011	31/10/2016
Water Discharge Licence for Wah Kwai	WT00013360-2012	8/8/2012	31/8/2017
Cancelled on 07/08/2013			
Water Discharge Licence for WCH Station	WT00014046-2012	24/9/2012	31/8/2016
Water Discharge Licence for Utilities Work Area Along Heung Yip Road	WT00014047-2012	25/9/2012	30/9/2017
Water Discharge Licence for Kwun Hoi Path	WT00015968-2013	02/05/2013	31/05/2018
CNP for Water Jet (C6 – C15)	GW-RS0392-13	21/04/2013	20/10/2013
CNP for Water Jet (D0 – D3)	GW-RS0390-13	21/04/2013	20/10/2013
CNP for Water pump (D3.5 stoplog)	GW-RS0584-13	24/05/2013	22/11/2013
CNP for Water Jet (C2 – C5) (Renewal of GW-RS1251-12)	GW-RS0599-13	03/06/2013	02/12/2013
CNP for Water Pump for Pipe Jacking at NLSR (Renewal of GW-RS0153-13)	GW-RS0667-13	30/06/2013	29/12/2013
CNP for Noise Barrier Installation in Zone E Viaduct	GW-RS0741-13	04/07/2013	31/12/2013
CNP for Zone D (Water pump for Stoplog) (Renewal of GW-RS0612-13)	GW-RS0823-13	31/07/2013	31/10/2013

Description		Effective Date	Expiry Date
CNP for Water Jet (D13-D18)	GW-RS0889-13	18/08/2013	16/02/2014
CNP for Breaking works at WCH Entrance A	GW-RS0932-13	24/08/2013	23/12/2013
CNP for Segment Erection (C0-C8)	GW-RS0936-13	21/08/2013	30/10/2013
Renewal of GW-RS0744-13			
CNP for ABWF works in OCP Station	GW-RS0957-13	30/08/2013	28/02/2014
CNP for ABWF works in WCH Station	GW-RS0941-13	30/08/2013	28/02/2014
CNP for Water pump (D1)	GW-RS1059-13	30/09/2013	31/12/2013
(Renewal of GW-RS0753-13)			
Cancelled and superseded by GW-RS1136-13			
CNP for Noise Barrier Installation in Zone D Viaduct (D8-D12)	GW-RS1138-13	18/10/2013	06/04/2014
CNP for Water Jet (C1 – C15)	GW-RS1147-13	20/10/2013	19/04/2014
CNP for Zone D (Water pump for Stoplog)	GW-RS1167-13	31/10/2013	30/04/2014
(Renewal of GW-RS0823-13)			
CNP for Noise Barrier Installation, Water jet and water pump in Zone D (D0-D4)	GW-RS1136-13	29/10/2013	23/04/2014
CNP for Segment Erection (C5)	GW-RS1178-13	30/10/2013	20/11/2013
CNP for Segment Repair and Polish (B3-B5)	GW-RS1180-13	29/10/2013	30/11/2013
Contract 904			
Chemical Waste Producer License for ALC Bridge Rd near Sham Wan Towers	5111-174-L2758-04	4/8/2011	N/A
Chemical Waste Producer License for ALC Bridge Rd near Harbour Mission School	5111-174-L2758-03	4/8/2011	N/A
Chemical Waste Producer License for ALC Main Street near Sunny Court	5111-174-L2758-05	4/8/2011	N/A
Chemical Waste Producer License for Lei Tung Estate Rd near Kaifong Primary School	5111-174-L2758-02	4/8/2011	N/A
Chemical Waste Producer License for Lee Nam Rd Sitting Out Area	5111-174-L2758-01	4/8/2011	N/A
Chemical Waste Producer License for Lee Nam Rd Sitting Out Area No. 2	5111-174-L2758-07	4/8/2011	N/A
Chemical Waste Producer License for Yi Nam Rd intersect with Lee Nam Rd & SOH Drive	5111-174-L2758-06	4/8/2011	N/A
Waste Disposal (Trucks)	7012979	25/6/2011	N/A
Waste Disposal (Vessels)	7015570	23/7/2012	N/A
Water Discharge License for ALC Bridge Rd near Sham Wan Towers	WT00009781-2011	5/8/2011	31/8/2016
Water Discharge License for ALC Bridge Rd near Harbour Mission School	WT00009778-2011	5/8/2011	31/8/2016
Water Discharge License for ALC Main Street near Sunny Court	WT00009777-2011	5/8/2011	31/8/2016
Water Discharge License for Lei Tung Estate Rd near Kaifong Primary School	WT00009780-2011	5/8/2011	31/8/2016
Water Discharge License for Lee Nam Rd Sitting Out Area	WT00009779-2011	5/8/2011	31/8/2016
Water Discharge License for Lee Nam Rd Sitting Out Area No. 2	WT00009783-2011	5/8/2011	31/8/2016
Water Discharge License for Yi Nam Rd intersect with Lee Nam Rd & SOH Drive	WT00009775-2011	5/8/2011	31/8/2016
Water Discharge License for Barging Point at Lee Nam Road J/O Lee King Street	WT00014348-2012	5/11/2012	30/11/2017
CNP for Pump Sump at ALC	GW-RS0867-13	3/8/2013	2/2/2014

Description		Effective Date	Expiry Date
CNP for LET Ent A Pumping Test	GW-RS0920-13	24/8/2013	23/2/2014
CNP for LET Ent B Shaft Excavation	GW-RS1023-13	13/9/2013	13/11/2013
CNP for SOH Package 2 and 3 Pumping Test	GW-RS0735-13	4/7/2013	3/1/2014
CNP for Lee Wing Building Tunnel	GW-RS0854-13	15/10/2013	15/12/2013
CNP for Dismantling of Conveyor Belt at Barging Point	GW-RS0959-13	3/9/2013	18/11/2013
Contract 908			
Waste Disposal	7014839	20/3/2012	N/A
Chemical Waste Producer Licence	5211-175-H2913-42	11/4/2012	N/A
Water Discharge Licence	WT000013232-2012	29/6/2012	31/5/2017
CNP for water pumping, water jetting unit and waste water treatment plant	GW-RS1039-13	19/09/2013	26/03/2014

11 *SITE INSPECTIONS*

11.1 *Implementation of Environmental Mitigation Measures*

Regular site inspections were undertaken by the ET in accordance with the EM&A Manual to check the implementation of environmental mitigation measures in the EIA. The contractors' performance on environmental matters was assessed. The environmental mitigation measures are being implemented by the civil works contractors where appropriate. A schedule of the implementation of mitigation measures indentified in the SIL(E) EIA is given in **Appendix F**.

11.2 *Observations*

The findings from the site inspections and the associated recommendations on improvement to the environmental protection and pollution control works were raised to the contractors for reference and/ or action. Observations against the implementation of the mitigation measures recommended in the EP/ EIA are summarized as follows:

Item	Description	Follow up Status
Contract 901		
1	The contractor was reminded to improve the site drainage system and divert all surface runoff to wastewater treatment system for proper treatment.	On-going
2	The contractor was reminded to improve the effluent quality.	Improved and standard to be maintained
3	The contractor was reminded to provide drip trays for chemicals.	On-going
4	The contractor was reminded to clear the content in drip trays as chemical waste.	On-going
5	The contractor was reminded no material shall be stored in Tree Protection Zone.	Improved and standard to be maintained
6	The contractor was reminded to remove water logging at the Tree Protection Zone.	On-going
Contract 902		
1	The contractor was reminded to provide drip tray during equipment maintenance works to prevent oil leakage.	Improved and standard to be maintained
2	The contractor was reminded to properly maintain the site drainage system and provide adequate silt removal facilities.	Improved and standard to be maintained
3	The contractor was reminded to properly maintain the tree protection zone.	Improved and standard to be maintained
4	The contractor was reminded to improve dust suppression measures.	Improved and standard to be maintained
5	The contractor is reminded to provide adequate noise mitigation measures.	Improved and standard to be maintained
Contract 903		
1	The contractor was reminded to maintain proper mitigation measures in the nullah for the effluent control.	On-going
2	The contractor was reminded to maintain the function of wastewater treatment facilities properly	On-going
3	The contractor was reminded to improve the tree protection works and maintain protective fencing along the tree protection zone.	On-going
4	The contractor was reminded to handle the chemical waste properly	On-going
5	The contractor was reminded to provide drip trays for chemical containers.	On-going
6	The contractor was reminded to maintain the silt curtain properly during seawall reinstatement.	On-going
7	The contractor was reminded to maintain haulroad and exit to maintain hardpaved and water spray to suppress dust.	On-going

Item	Description	Follow up Status
Contract 904		
1	The contractor was reminded to provide drip tray during equipment maintenance works to prevent oil leakage.	Improved and standard to be maintained
2	The contractor was reminded to maintain good housekeeping.	Improved and standard to be maintained
3	The contractor was reminded to provide adequate silt removal facilities, as well as properly maintain the site drainage system and discharge.	On-going
4	The contractor was reminded to improve dust suppression measures.	Improved and standard to be maintained
5	The contractor was reminded to provide adequate noise mitigation measures.	On-going
6	The contractor was reminded to properly maintain the tree protection zone.	Improved and standard to be maintained
7	The contractor was advised to ensure covering of the load of dumping truck before leaving to the site area.	Improved and standard to be maintained
Contract 908		
1	Earthy stockpile shall be covered with tarpaulin sheets to prevent dust generation..	Improved and standard to be maintained
2	Seeping of grey water from gaps of hoarding to Nam Long Shan Road was observed and immediate follow up actions were required.	Improved and standard to be maintained
3	Drip pan shall be provided for chemicals being used on site.	Improved and standard to be maintained
4	Underground water generated from excavation was found directly discharged into public drain without treatment	Improved and standard to be maintained
5	General wastes shall be regularly collected and disposed by licensed waste collector to maintain good housekeeping and hygiene condition on site.	Improved and standard to be maintained
6	Water spraying shall be provided for concrete or boulder breaking activities to minimize dust generation	Improved and standard to be maintained

11.3 Solid and Liquid Waste Management Status

Base on the findings of the site inspections, the Contractors' performance in solid and liquid waste management were acceptable and compliance with the EIA requirements were demonstrated. The current management standard should be maintained.

11.4 Other Notable Events

IEC Site Inspections

The IEC conducted site inspections for respective works areas on 7, 10, 16 and 17 October 2013. Minor irregularities including provision of movable noise barriers as necessary and enhancing site drainage system and dust suppression measures were observed during the site inspections. Follow up actions had been taken by the respective civil works contractors.

12 FUTURE KEY ISSUES

Future key issues envisaged in the coming month include noise and dust emission from site works, disposal of C&D wastes arising as well as tree protection on site. There would be a minor adjustment in the construction sequence in the forthcoming months such that the adit of Lei Tung Entrance B (LET Ent B) would be constructed by the explosives delivered via the LET Ent B shaft instead of that from the main tunnel. The number of explosive deliveries to LET Ent B shaft as a whole would remain similar during the peak year as there would also be a reduction in the quantity of explosives required by the original construction arrangement. The QRA review based on the updated explosive delivery programme show that both the resultant individual and societal risk levels would be below those of the original scenario (refer to Appendix G for a summary of the review). Since the excavation area and depth of shaft and adit would remain unchanged, and with the implementation of the mitigation measures as specified in the Environmental Permit and / C&DMMP, construction dust, noise, water quality and waste management implications due to this minor reshuffle of construction sequence would remain acceptable and in compliance with the EIAO-TM requirements. The ET will continue the implementation of the EM&A programme in accordance to the EM&A Manual.

13 CONCLUSIONS

It is concluded from the environmental monitoring and audit works for the SIL(E) Project that the construction works were undertaken in an appropriately environmentally sensitive manner in the reporting period. The environmental protection and pollution control measures provided by the respective civil works contractors were generally acceptable apart from some minor irregularities which were rectified timely by the contractors.

The ET will continue the implementation of the EM&A programme in accordance to the EM&A Manual and to a level consistent with MTRCL's Corporate Sustainability Policy.

FIGURES

Figures 1 to 2
Works Areas of the Project

Figures 3 to 6
Location of Construction Air Quality
Monitoring Stations

Figures 7 to 8
Location of Construction Noise
Monitoring Stations

Figure 9
Location of Water Quality Monitoring
Stations

Figure 10
Air Quality and Noise Monitoring Locations for
Telegraph Bay Barging Point

Figure 1 – Works Areas of the Project (1 of 2)

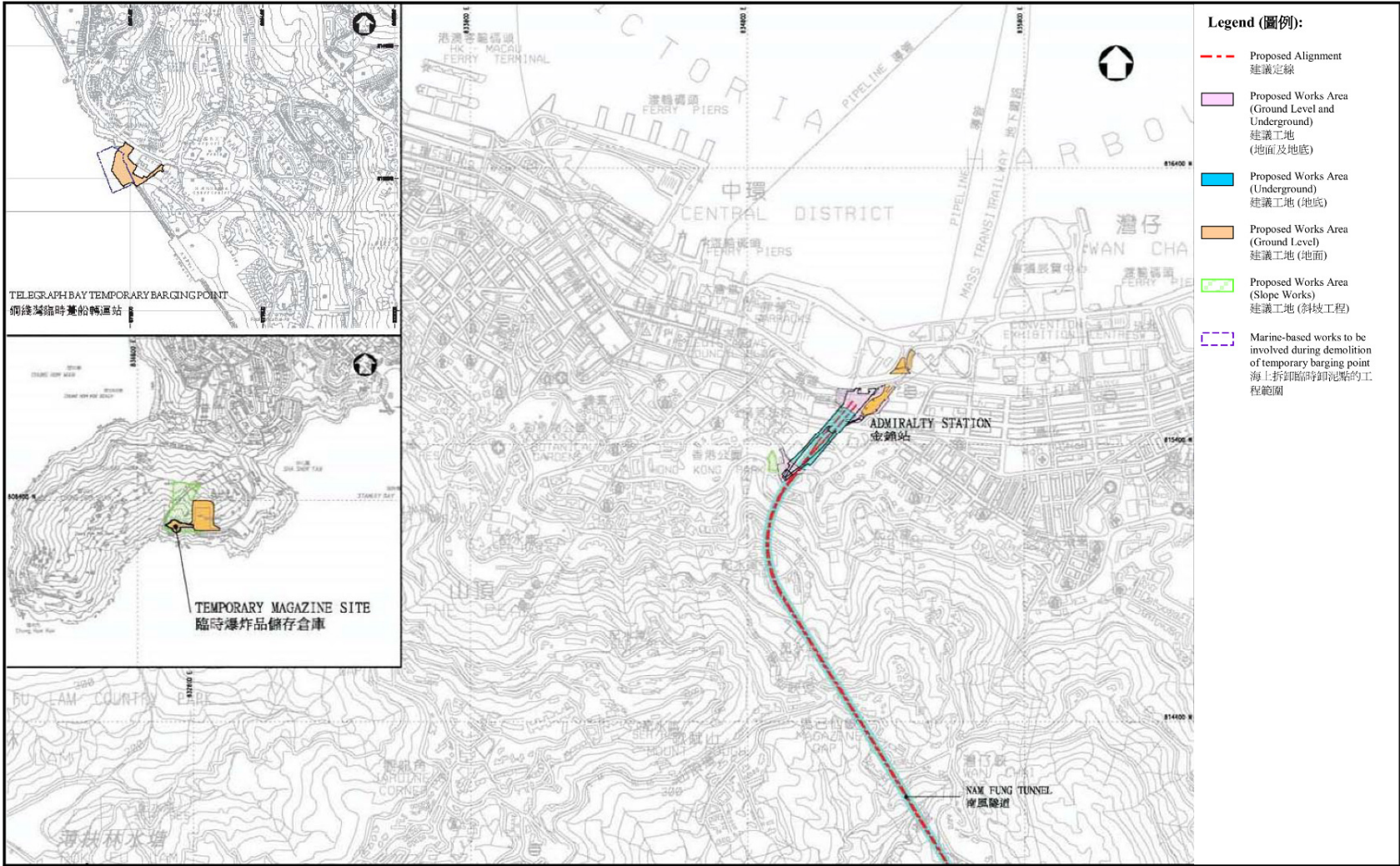

Figure 2 – Works Areas of the Project (2 of 2)

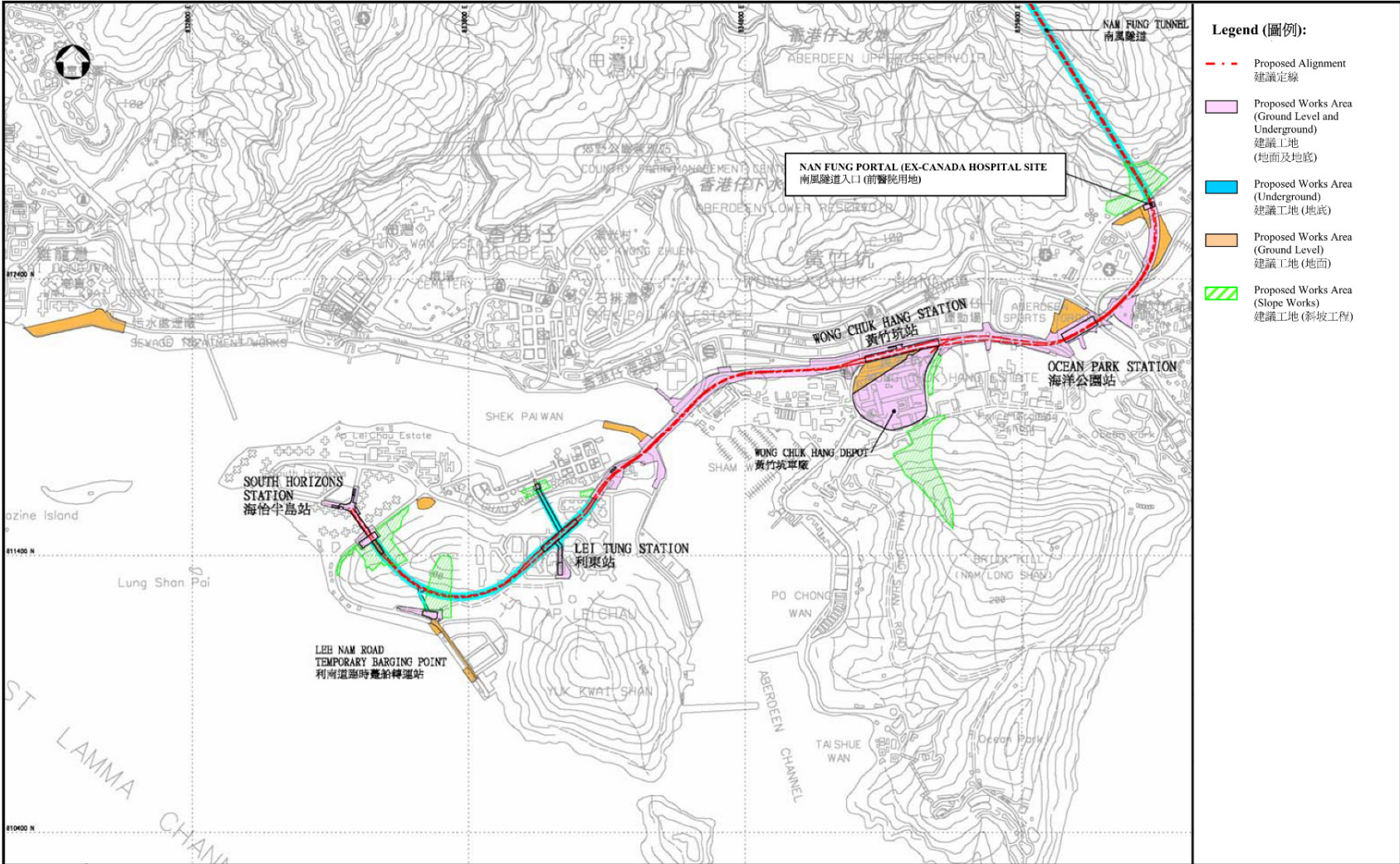

Figure 3 – Location of Construction Air Quality Monitoring Stations (1 of 4)

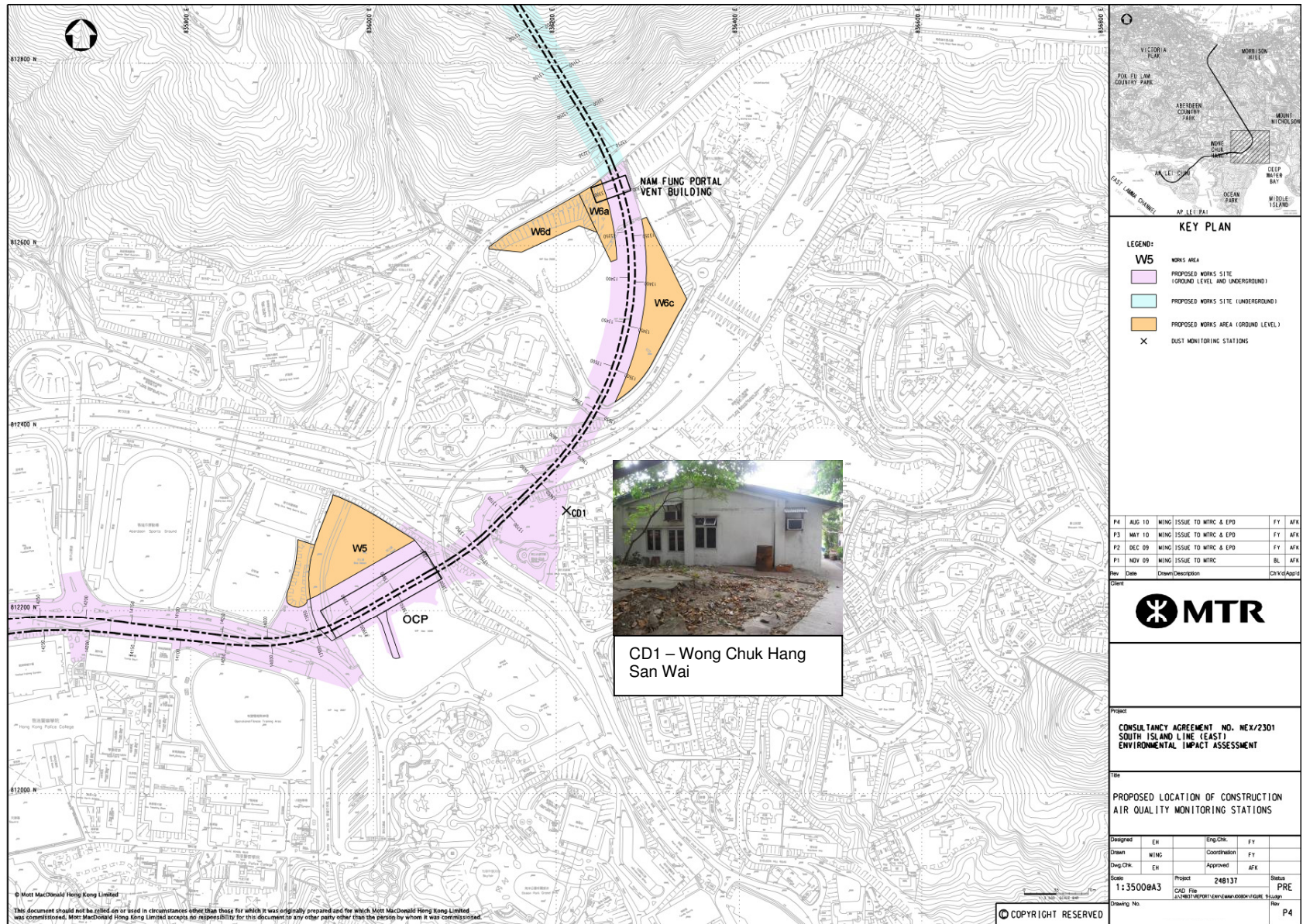

Figure 4 – Location of Construction Air Quality Monitoring Stations (2 of 4)

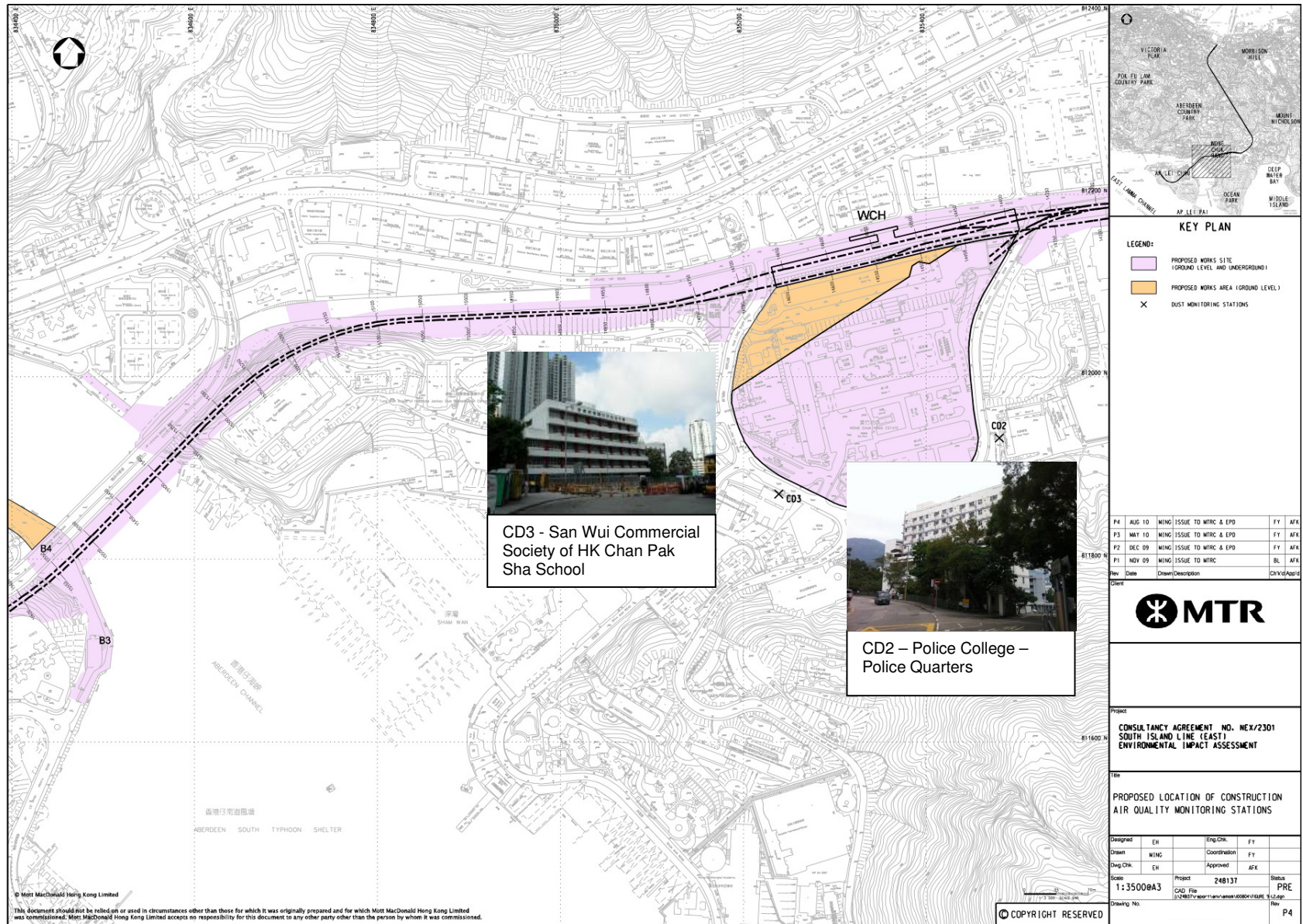

Figure 6 – Location of Construction Air Quality Monitoring Stations (4 of 4)



Figure 7 – Location of Construction Noise Monitoring Stations (1 of 2)

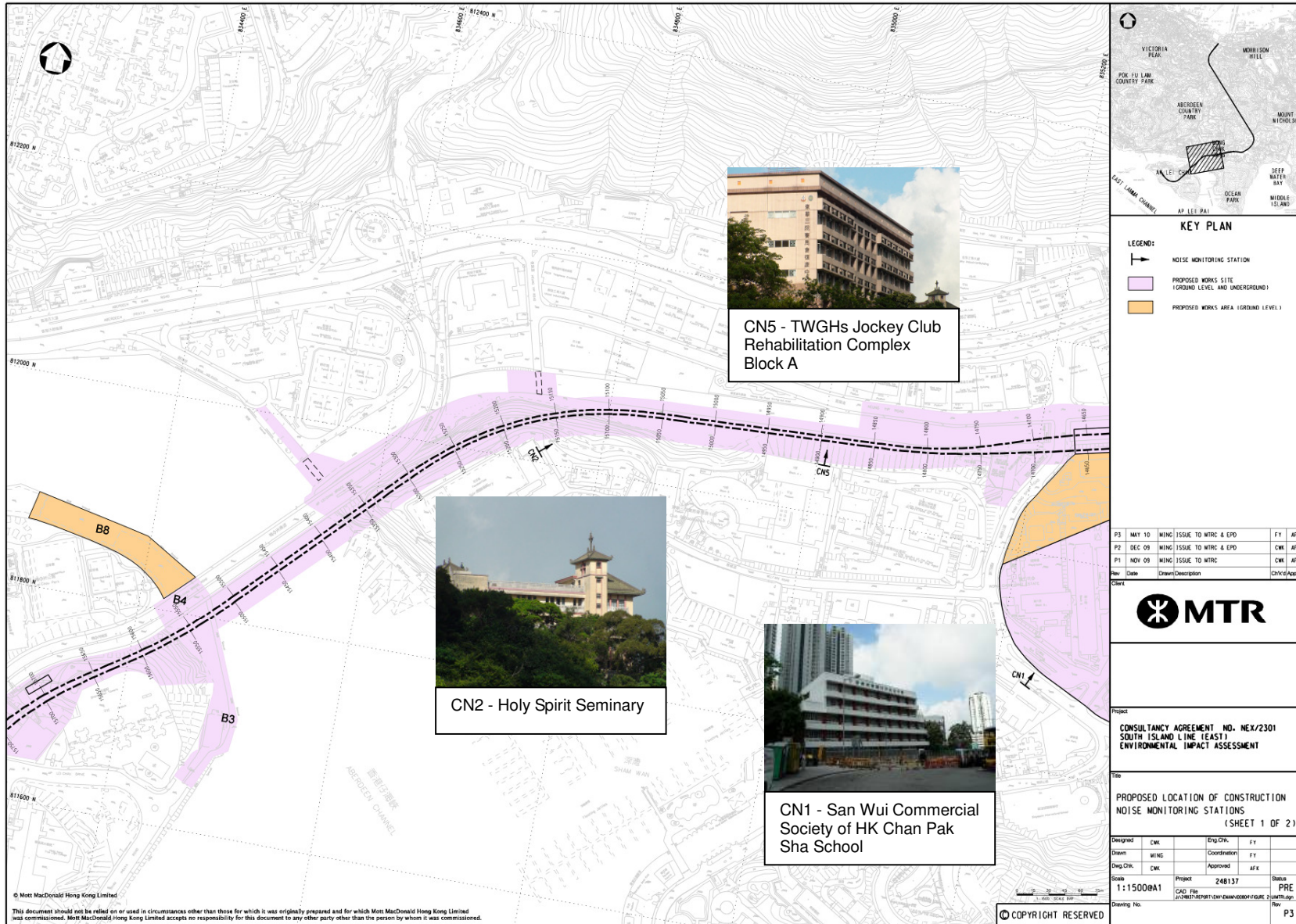

Figure 8 – Location of Construction Noise Monitoring Stations (2 of 2)

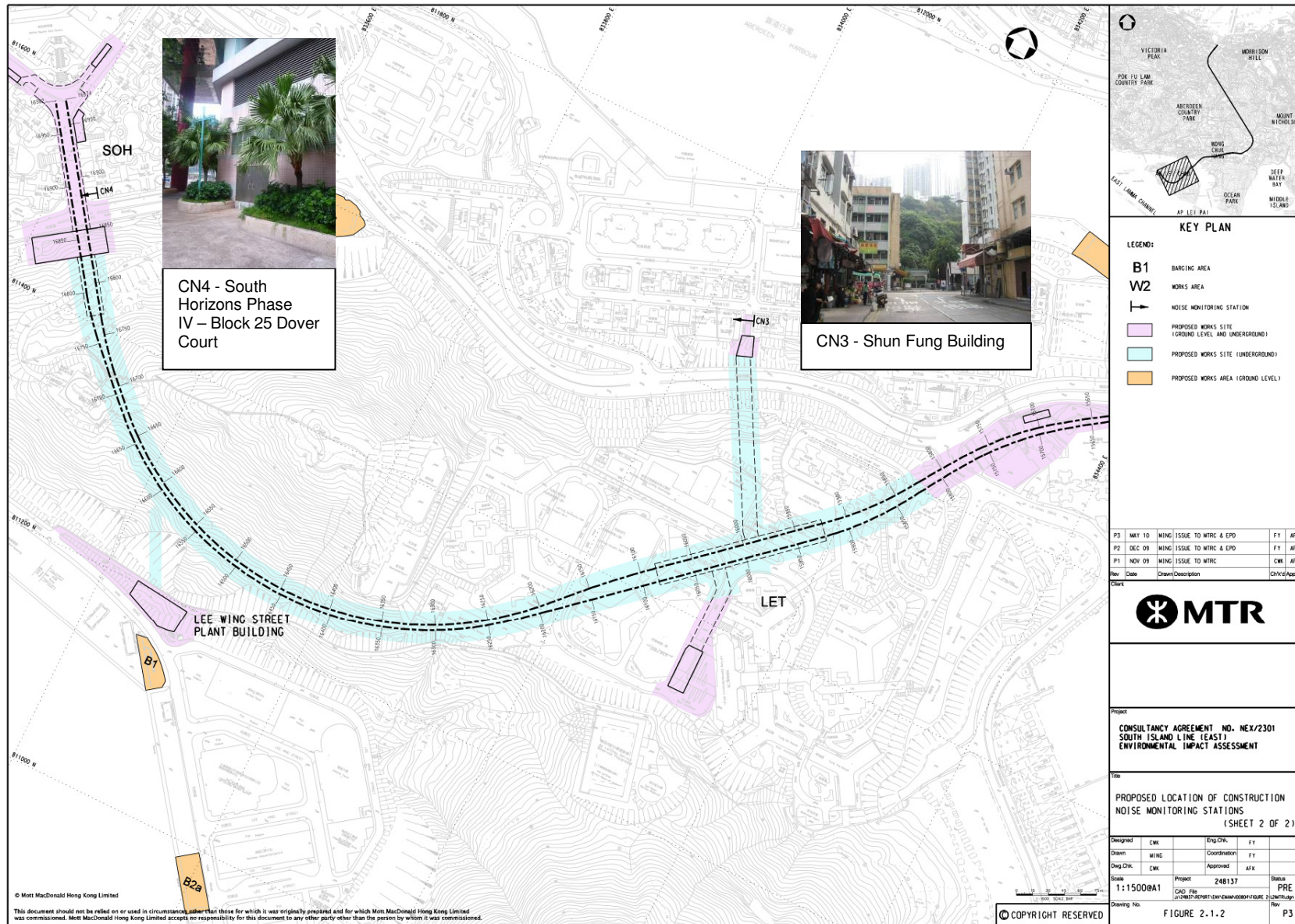

Figure 9 – Location of Water Quality Monitoring Stations

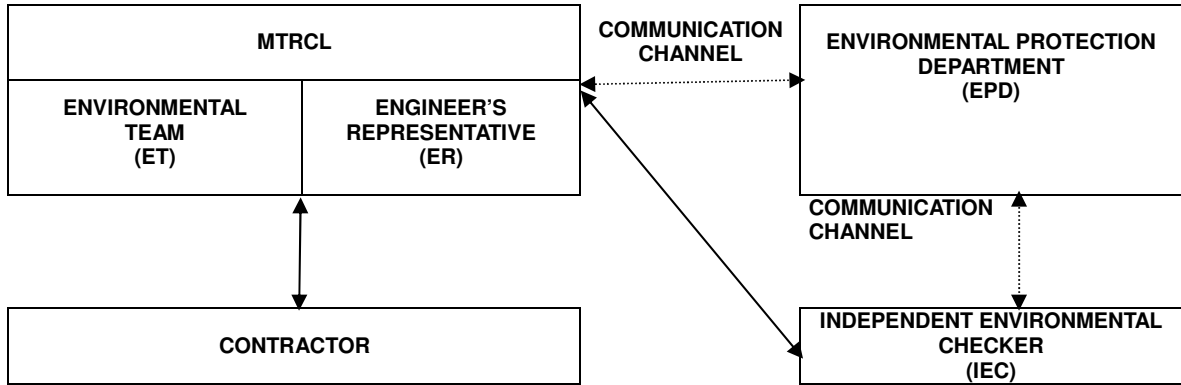

Figure 10 – Air Quality and Noise Monitoring Locations for Telegraph Bay Barging Point



APPENDIX A1
Project Organization

Appendix A1
Project Organization and Lines of Communications



APPENDIX A2

Contact List of Key Personal of the Project

Appendix A2
Contact List of Key Personnel

Table A2.1 Contact List of Key Personnel of Project Management

Organization	Name	Telephone
Independent Environmental Checker	Mr. Thomas Chan	2268 3093
Environmental Team Leader	Mr. Richard Kwan	2688 1179
Engineer's Representative		
Project Manager – SIL Civil	Mr. Mark Cuzner	3987 8288
	Mr. Ken Wong <i>(effective 15 Oct 2013)</i>	2285 4688
Construction Manager – SIL (901)	Mr. Robert James	2206 8688
Construction Manager – SIL (902 / 904)	Mr. Ken Wong	2285 4688
Construction Manager – SIL (903 / 907 / 908)	Mr. Kit Chan	3975 6988
Contract No. 901		
Admiralty Integrated Station and SCL Enabling Works		
Main Contractor: Kier – Laing O'Rourke – Kaden Joint Venture		
Project Director	Mr. Viv Jones	9248 8482
QA & Environmental Manager	Mr. Ronald Fung	9777 7667
Contract No. 902		
Nam Fung Tunnel and Ventilation Buildings		
Main Contractor: Nishimatsu Construction Co., Ltd.		
Project Manager	Mr. Masanori Ishii	6112 6707
Senior Construction Manager (External)	Toshiya Fujita	3190 7500
Senior Construction Manager (Tunnel)	Norihisa Murakawa	3190 7500
Contract No. 903		
Ocean Park Station, Wong Chuk Hang Station, Viaduct and Aberdeen Channel Bridge		
Main Contractor: Leighton Contractors (Asia) Ltd.		
Project Director	Mr. Paul Freeman	9856 1988
Project Manager, Stations and Nullah	Mr. Ian Rawsthorne	9383 0735
Project Manager, Viaducts, Bridge and Precast	Mr. Jon Kitching	9101 9013

Organization	Name	Telephone
Contract No. 904		
Lei Tung Station, South Horizons Station and Tunnels		
Main Contractor: Leighton – John Holland Joint Venture		
Project Director	Mr. Wes Jones	9313 8612
Acting Project Director	Mr. Brian Shepstone	9850 8708
Contract No. 908		
Wong Chuk Hang Depot Superstructure		
Main Contractor: Hsin Chong Construction Company Limited		
Project Manager	Mr. Daniel Wong	9199 9867
Construction Manger	Mr. Jackson Lau	9105 1395

Table A2.2 Contact List of Key Personnel of EPD

Organization	Name	Telephone
EPD		
Sr Env Protection Offr (Metro Assessment)	Mr. Steve Li	2835 1142
Sr Env Protection Offr (Regional S)	Dr. Anthony Lee	2516 1802
Sr Env Protection Offr (Regional S)	Mr. Sean Law	2516 1806

APPENDIX B1

Action and Limit Levels for Construction Noise and Air Quality

Appendix B1

Action and Limit Levels for Construction Noise and Air Quality

Action and Limit Levels for 24-hours TSP

Table B1.1 Action and Limit Levels for 24-hour TSP

ID	Description	Action Level ($\mu\text{g}/\text{m}^3$)	Limit Level ($\mu\text{g}/\text{m}^3$)
CD1	Wong Chuk Hang San Wai	173	260
CD2	Police College – Police Quarters	184	260
CD3	San Wui Commercial Society of HK Chan Pak Sha School	169	260
CD4	Shan On House	176	260
CD5	South Horizons Phase IV – Block 25	169	260

Note: TSP levels are to the nearest whole number, with values of 0.5 rounded up

Action and Limit Levels for 1-hour TSP

Table B1.2 Action and Limit Levels for 1-hour TSP

ID	Description	Action Level ($\mu\text{g}/\text{m}^3$)	Limit Level ($\mu\text{g}/\text{m}^3$)
CD1	Wong Chuk Hang San Wai	315	500
CD2	Police College – Police Quarters	311	500
CD3	San Wui Commercial Society of HK Chan Pak Sha School	322	500
CD4	Shan On House	318	500
CD5	South Horizons Phase IV – Block 25	336	500

Note: 1-hour TSP criterion recommended in the EIAO-TM
TSP levels are to the nearest whole number, with values of 0.5 rounded up

Action and Limit Levels for Construction Noise

Table B1.3 Action and Limit Levels for Construction Noise

Time Period	Action Level	Limit Level
Daytime (0700-1900), Monday through Saturday excluding Public Holidays	When one document complaint received.	$L_{Aeq\ 30mins} 75dB(A)^{(1)(2)}$
All evenings (1900-2300)		Subject to control under the Noise Control Ordinance
General Holidays (including all Sundays) during the daytime and evening (0700-2300)		Subject to control under the Noise Control Ordinance
All night time periods (2300-0700)		Subject to control under the Noise Control Ordinance

(1) 70dB(A) for schools and 65dB(A) during school examination periods.

(2) Updated prediction of noise levels as contained in the construction noise mitigation measures plan.

APPENDIX B2

Action and Limit Levels for Water Quality

Appendix B2
Action and Limit Levels for Water Quality

Table B2.1 Action and Limit Levels for Ebb Condition

Tide: Ebb				
Location: WM1				
Parameters	Action Level		Limit Level	
DO in mg/L	Surface	5.9	Surface	5.5
	Middle	6.0	Middle	5.6
	Bottom	6.0	Bottom	5.7
SS in mg/L (depth averaged)	120% of upstream control station of the same day		130% of upstream control station of the same day	
Turbidity in NTU (depth averaged)	120% of upstream control station of the same day		130% of upstream control station of the same day	
Tide: Ebb				
Location: WM2				
Parameters	Action Level		Limit Level	
DO in mg/L	Surface	5.9	Surface	5.5
	Middle	NA	Middle	NA
	Bottom	6.0	Bottom	5.7
SS in mg/L (depth averaged)	120% of upstream control station of the same day		130% of upstream control station of the same day	
Turbidity in NTU (depth averaged)	120% of upstream control station of the same day		130% of upstream control station of the same day	
Tide: Ebb				
Location: WM3				
Parameters	Action Level		Limit Level	
DO in mg/L	Surface	6.1	Surface	5.7
	Middle	6.1	Middle	5.7
	Bottom	6.3	Bottom	5.9
SS in mg/L (depth averaged)	120% of upstream control station of the same day		130% of upstream control station of the same day	
Turbidity in NTU (depth averaged)	120% of upstream control station of the same day		130% of upstream control station of the same day	
Tide: Ebb				
Location: WM4				
Parameters	Action Level		Limit Level	
DO in mg/L	Surface	6.1	Surface	5.8
	Middle	6.3	Middle	6.0
	Bottom	6.5	Bottom	6.2
SS in mg/L (depth averaged)	120% of upstream control station of the same day		130% of upstream control station of the same day	
Turbidity in NTU (depth averaged)	120% of upstream control station of the same day		130% of upstream control station of the same day	

Table B2.2 Action and Limit Levels for Flood Condition

Tide: Flood				
Location: WM1				
Parameters	Action Level		Limit Level	
DO in mg/L	Surface	5.9	Surface	5.6
	Middle	6.1	Middle	5.7
	Bottom	6.2	Bottom	5.8
SS in mg/L (depth averaged)	120% of upstream control station of the same day		130% of upstream control station of the same day	
Turbidity in NTU (depth averaged)	120% of upstream control station of the same day		130% of upstream control station of the same day	
Tide: Flood				
Location: WM2				
Parameters	Action Level		Limit Level	
DO in mg/L	Surface	6.0	Surface	5.7
	Middle	NA	Middle	NA
	Bottom	6.1	Bottom	5.8
SS in mg/L (depth averaged)	120% of upstream control station of the same day		130% of upstream control station of the same day	
Turbidity in NTU (depth averaged)	120% of upstream control station of the same day		130% of upstream control station of the same day	
Tide: Flood				
Location: WM3				
Parameters	Action Level		Limit Level	
DO in mg/L	Surface	6.0	Surface	5.7
	Middle	6.2	Middle	5.8
	Bottom	6.2	Bottom	5.9
SS in mg/L (depth averaged)	120% of upstream control station of the same day		130% of upstream control station of the same day	
Turbidity in NTU (depth averaged)	120% of upstream control station of the same day		130% of upstream control station of the same day	
Tide: Flood				
Location: WM4				
Parameters	Action Level		Limit Level	
DO in mg/L	Surface	6.0	Surface	5.8
	Middle	6.2	Middle	5.8
	Bottom	6.3	Bottom	6.1
SS in mg/L (depth averaged)	120% of upstream control station of the same day		130% of upstream control station of the same day	
Turbidity in NTU (depth averaged)	120% of upstream control station of the same day		130% of upstream control station of the same day	

APPENDIX C

Calibration Details

Summary of Calibration Certificate

Noise Equipment

Model	Serial Number	Calibration Date	Expiry Date	Remark
B&K 2250L	2741137	18 Jan 2013	18 Jan 2015 ^[1]	
B&K 2250	2551244	18 Jan 2013	18 Jan 2015 ^[1]	
B&K 4231 Calibrator	2725557	18 Jan 2013	18 Jan 2015 ^[2]	

High Volume Sampler

Model	Sampler	Calibration Date	Expiry Date	Remark
Graseby-Andersen	694-0661	17 Jul 2013	17 Jan 2014 ^[3]	
Graseby-Andersen	894-0833	17 Jul 2013	17 Jan 2014 ^[3]	
Graseby-Andersen	994-0878	17 Jul 2013	17 Jan 2014 ^[3]	
Graseby-Andersen	1294-1104	17 Jul 2013	17 Jan 2014 ^[3]	
Graseby-Andersen	1294-1111	17 Jul 2013	17 Jan 2014 ^[3]	
Graseby-Andersen	694-0664	17 Jul 2013	17 Jan 2014 ^[3]	

Water Quality Monitoring Equipment

Model	Serial Number	Calibration Date	Expiry Date	Remark
Turbidimeter				
HACH 2100Q	11060C010010	9 Jul 2013	8 Oct 2013 ^[4]	
HACH 2100Q	11060C010010	8 Oct 2013	7 Jan 2014	
pH Meter				
HANNA HI8314	674469	9 Sep 2013	8 Oct 2013	
HANNA HI8314	674469	9 Oct 2013	8 Nov 2013	
Multimeter for Temperature / Dissolved Oxygen / Salinity				
YSI Pro2030	12A 100353	31 Jul 2013	30 Oct 2013 ^[4]	
YSI Pro2030	12A 100353	29 Oct 2013	28 Jan 2014	

- Note: [1] Calibration certificates refer to Appendix C of EM&A report - February 2013
 [2] Calibration certificates refer to Appendix C of EM&A report - May 2013
 [3] Calibration certificates refer to Appendix C of EM&A report - August 2013
 [4] Calibration certificates refer to Appendix C of EM&A report - September 2013



Performance Check of Turbidity Meter

Equipment Ref. No. : ET/0505/009 Manufacturer : HACH
Model No. : 2100Q Serial No. : 11060 C 010010
Date of Calibration : 08/10/2013 Due Date : 07/01/2014

Gelex Vial Std	Theoretical Value (NTU)	Measured Value (NTU)	Difference %
0-10 NTU	5	5.2	3.92
10-100 NTU	50	5.19	3.73
100-1000 NTU	550	561	1.98

Acceptance Criteria

Difference : -5 % to 5%

The turbidity meter complies * / ~~does not comply~~ * with the specified requirements and is deemed acceptable * / ~~unacceptable~~ * for use. Measurements are traceable to national standards.

Checked by : 

Approved by : 



Internal Calibration & Performance Check Report of pH Meter

Equipment Ref. No. : ET/EW/007/003 Manufacturer : HANNA
 Model No. : HI 8314 Serial No. : 674469
 Date of Calibration : 09/09/2013 Calibration Due Date : 08/10/2013

Liquid Junction Error

Primary Standard Solution Used : Phosphate Ref No. of Primary Solution: 003/5.2/001/15
 Temperature of Solution : 19.9 pH_½ = +0.08
 pH value of diluted buffer : 6.8 pH (S) = 6.881
 pH = pH(S) - pH of diluted buffer = 0.081 (Observed Deviation)
 Liquid Junction Error (ΔpH_j) = pH - pH_½ = 0.001

Shift on Stirring

pH of buffer solution (with stirring), pH_s = 6.89
 Shift on stirring, $\Delta\text{pH}_s = \text{pH}_s - \text{pH(S)} - \Delta\text{pH}_j =$ 0.008

Noise

Noise, pH_n = difference between max and min reading : 0.01

Verification of ATC

Ref. No. of reference thermometer used: ET/0521/008
 Temperature record from the reference thermometer (T_R): 20.0 °C
 Temperature record from the ATC (T_{ATC}): 19.8 °C
 Temperature Difference (T_R - T_{ATC}): 0.2 °C

Acceptance Criteria

Performance Characteristic	Acceptable Range
Liquid Junction Error pH _j	≤0.05
Shift on Stirring pH _s	≤0.02
Noise pH _n	≤0.02
Verification of ATC Temperature Difference	≤0.5°C

The pH meter complies * / does not comply * with the specified requirements and is deemed acceptable * / unacceptable * for use. Measurements are traceable to national standards.

* Delete as appropriate

Calibrated by :  Approved Signatory : 



Internal Calibration & Performance Check of pH Meter

Equipment Ref. No. : ET/EW/007/003 Manufacturer : HANNA
 Model No. : HI 8314 Serial No. : 674469
 Date of Calibration : 09/10/2013 Calibration Due Date : 08/11/2013

Liquid Junction Error

Primary Standard Solution Used : Phosphate Ref No. of Primary Solution: 003/5.2/001/15
 Temperature of Solution : 20.0 $\Delta\text{pH}_{1/2} = \underline{+0.08}$
 pH value of diluted buffer : 6.81 pH (S) = 6.881
 $\Delta\text{pH} = \text{pH(S)} - \text{pH of diluted buffer} = \underline{0.071}$ (Observed Deviation)
 Liquid Junction Error (ΔpH_j) = $\Delta\text{pH} - \Delta\text{pH}_{1/2} = \underline{-0.009}$

Shift on Stirring

pH of buffer solution (with stirring), $\text{pH}_s = \underline{6.88}$
 Shift on stirring, $\Delta\text{pH}_s = \text{pH}_s - \text{pH(S)} - \Delta\text{pH}_j = \underline{0.008}$

Noise

Noise, $\Delta\text{pH}_n = \text{difference between max and min reading} : \underline{0.01}$

Verification of ATC

Ref. No. of reference thermometer used: ET/0521/008 °C
 Temperature record from the reference thermometer (T_R): 20.0 °C
 Temperature record from the ATC (T_{ATC}): 19.7 °C
 Temperature Difference, $|T_R - T_{ATC}|$: 0.3 °C

Acceptance Criteria

Performance Characteristic	Acceptable Range
Liquid Junction Error ΔpH_j	≤ 0.05
Shift on Stirring ΔpH_s	≤ 0.02
Noise ΔpH_n	≤ 0.02
Verification of ATC Temperature Difference	$\leq 0.5^\circ\text{C}$

The pH meter complies * / does not comply * with the specified requirements and is deemed acceptable * / unacceptable * for use. Measurements are traceable to national standards.

* Delete as appropriate

Calibrated by :

Checked by :



Internal Calibration Report of Dissolved Oxygen Meter

Equipment Ref. No. : <u>ET/EW/008/005</u>	Manufacturer : <u>YSI</u>
Model No. : <u>Pro 2030</u>	Serial No. : <u>12A 100353</u>
Date of Calibration : <u>29/10/2013</u>	Calibration Due Date : <u>28/01/2014</u>

Temperature Verification

Ref. No. of Reference Thermometer : ET/0521/008
 Ref. No. of Water Bath : ---

		Temperature (°C)		
Reference Thermometer reading	Measured	20.3	Corrected	19.9
DO Meter reading	Measured	19.8	Difference	0.1

Standardization of sodium thiosulphate (Na₂S₂O₃) solution

Reagent No. of Na ₂ S ₂ O ₃ titrant	CPE/012/4.5/001/7	Reagent No. of 0.025N K ₂ Cr ₂ O ₇	CPE/012/4.4/001/22
		Trial 1	Trial 2
Initial Vol. of Na ₂ S ₂ O ₃ (ml)		1.00	12.00
Final Vol. of Na ₂ S ₂ O ₃ (ml)		11.55	22.50
Vol. of Na ₂ S ₂ O ₃ used (ml)		10.55	10.50
Normality of Na ₂ S ₂ O ₃ solution (N)		0.02370	0.02381
Average Normality (N) of Na ₂ S ₂ O ₃ solution (N)		0.02376	
Acceptance criteria, Deviation		Less than ± 0.001N	

Calculation: Normality of Na₂S₂O₃, N = 0.25 / ml Na₂S₂O₃ used

Lineality Checking

Determination of dissolved oxygen content by Winkler Titration *

Purging Time (min)	2		5		10	
	1	2	1	2	1	2
Initial Vol. of Na ₂ S ₂ O ₃ (ml)	0.00	11.80	23.40	0.00	8.00	13.00
Final Vol. of Na ₂ S ₂ O ₃ (ml)	11.80	23.40	31.50	8.00	13.00	18.10
Vol. (V) of Na ₂ S ₂ O ₃ used (ml)	11.80	11.60	8.10	8.00	5.00	5.10
Dissolved Oxygen (DO), mg/L	7.53	7.40	5.17	5.10	3.19	3.25
Acceptance criteria, Deviation	Less than + 0.3mg/L		Less than + 0.3mg/L		Less than + 0.3mg/L	

Calculation: DO (mg/L) = V x N x 8000/298

Purging time, min	DO meter reading, mg/L			Winkler Titration result *, mg/L			Difference (%) of DO Content
	1	2	Average	1	2	Average	
2	7.66	7.41	7.54	7.53	7.40	7.47	0.93
5	5.31	5.23	5.27	5.17	5.10	5.14	2.50
10	3.20	3.10	3.15	3.19	3.25	3.22	2.20
Linear regression coefficient				0.9987			



Performance Check of Salinity Meter

Equipment Ref. No. : ET/EW/008/005 Manufacturer : YSI
Model No. : Pro 2030 Serial No. : 12A 100353
Date of Calibration : ^{29/10/2013} ~~29/08/2013~~ _{29/08/2013} Due Date : 28/01/2014

Ref. No. of Salinity Standard used (30ppt)

S/001/4

Salinity Standard (ppt)	Measured Salinity (ppt)	Difference %
30.0	30.8	2.63

Acceptance Criteria

Difference : <10 %

The salinity meter complies * / ~~does not comply~~ * with the specified requirements and is deemed acceptable * / ~~unacceptable~~ * for use. Measurements are traceable to national standards.

Checked by : 

Approved by : 

APPENDIX D

Graphical Plots of Air Quality, Noise & Water Quality Impact Monitoring
and Monitoring Results for Water Quality

Graphical Plots of Air Quality Monitoring Results

24-hr TSP Level at CD1 Wong Chuk Hang San Wai

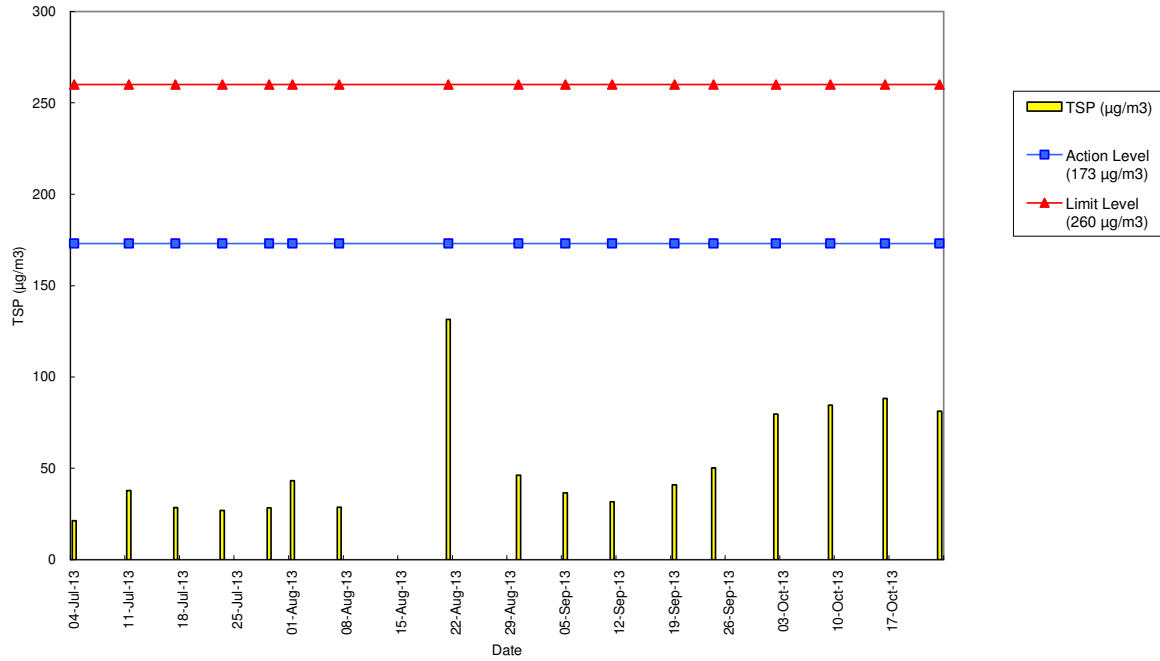

24-hr TSP Level at CD2 Police College - Police Quarters

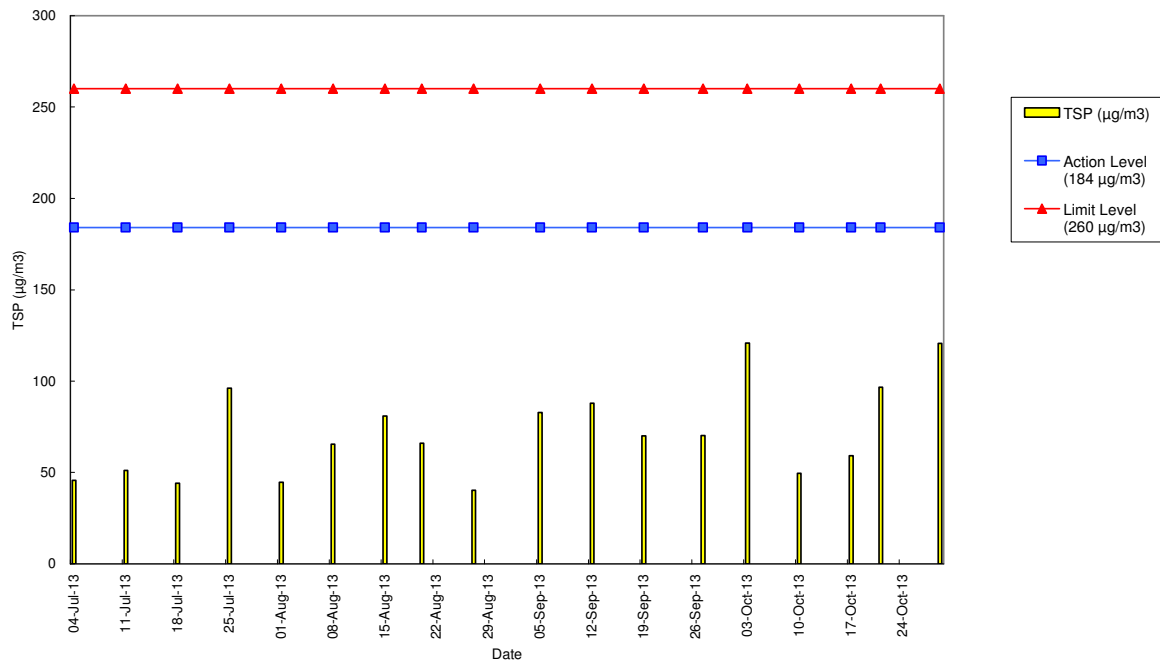

Graphical Plots of Air Quality Monitoring Results

24-hr TSP Level at CD3 San Wui Commercial Society of HK Chan Pak Sha School

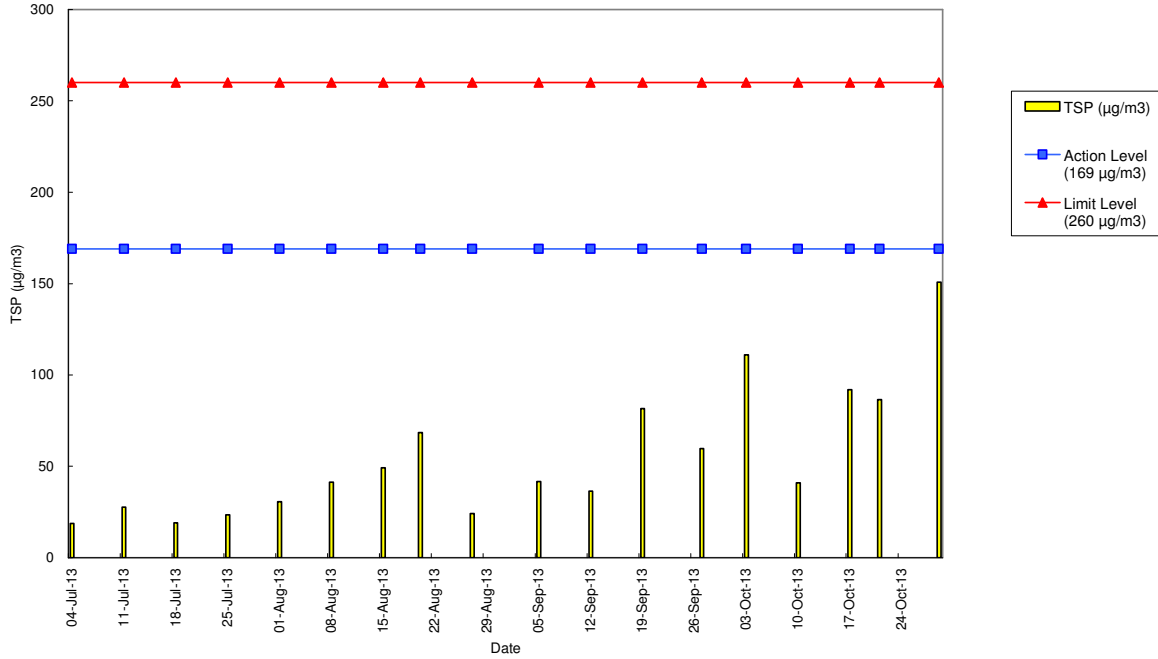

24-hr TSP Level at CD4 Shan On House

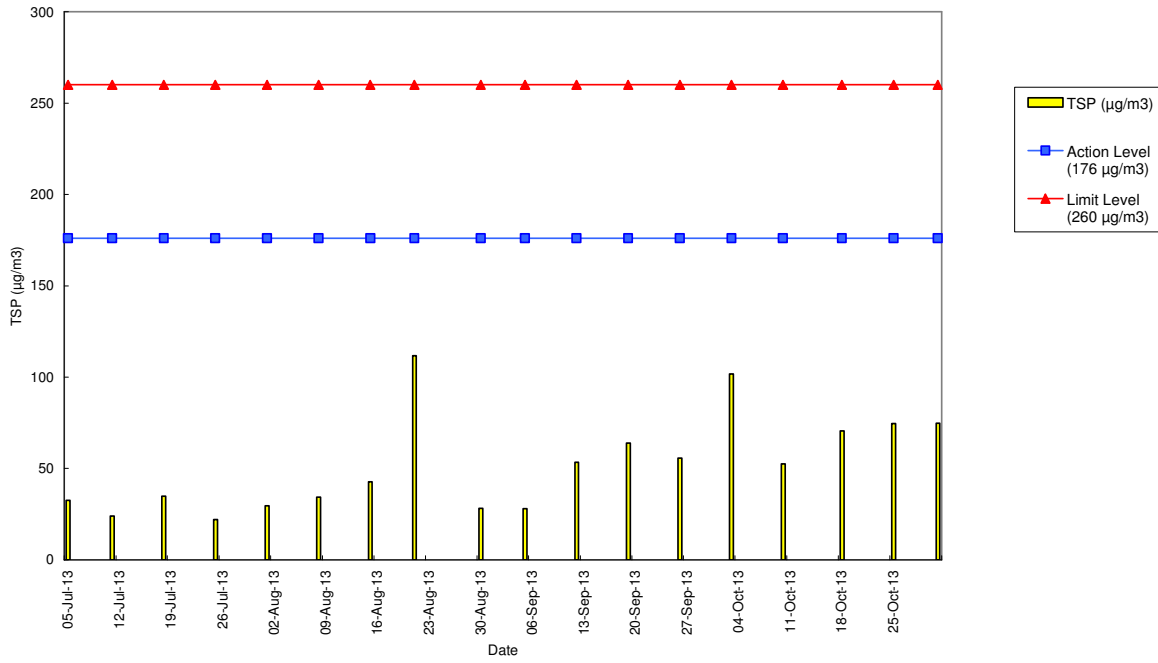

Graphical Plots of Air Quality Monitoring Results

24-hr TSP Level at CD5 South Horizons Phase IV – Block 25

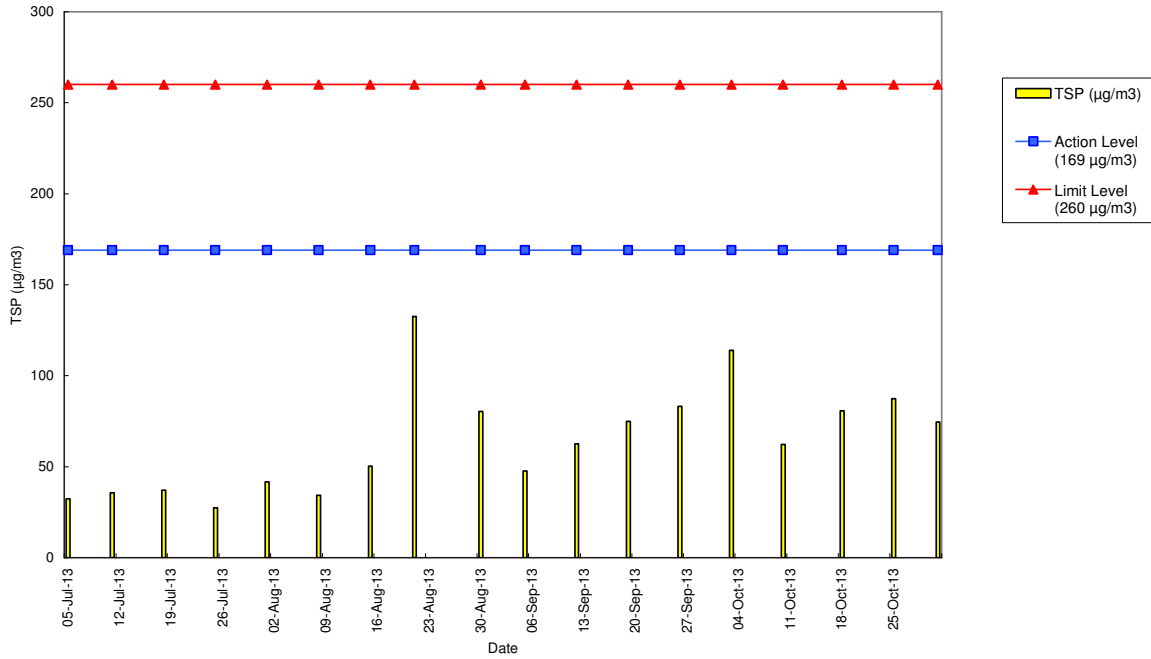

24-hr TSP Level at DTB1 Site Boundary of Telegraph Bay Barging Point

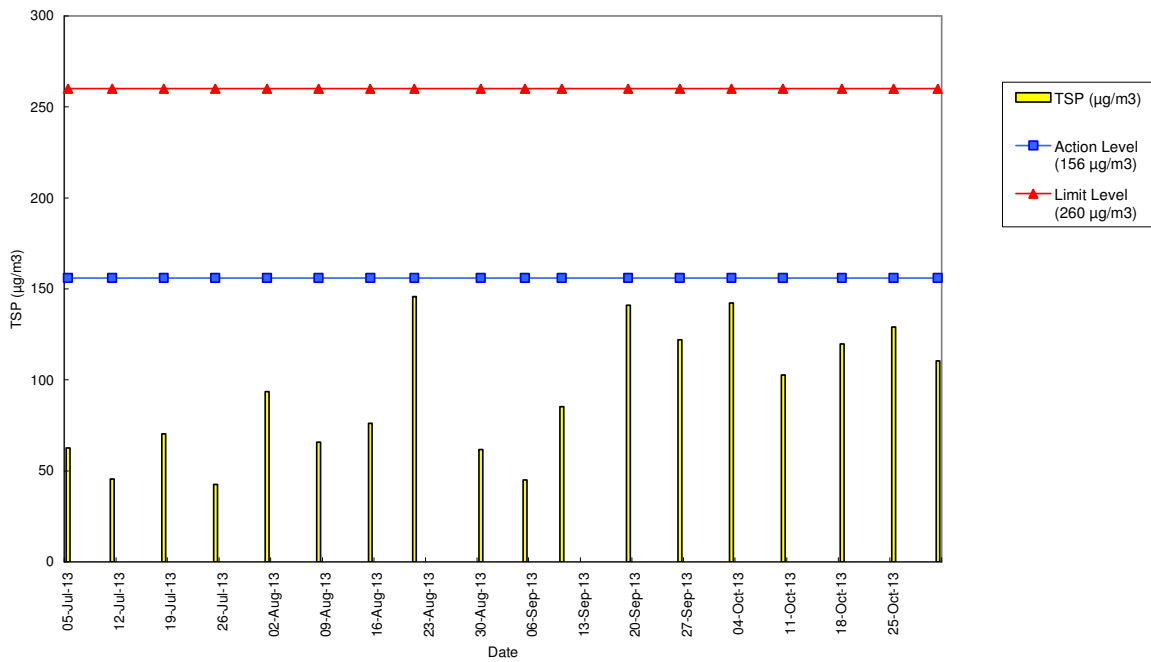

Graphical Plots of Noise Monitoring Results

Noise Level at CN1 San Wui Commercial Society of HK Chan Pak Sha School (Educational Institution)

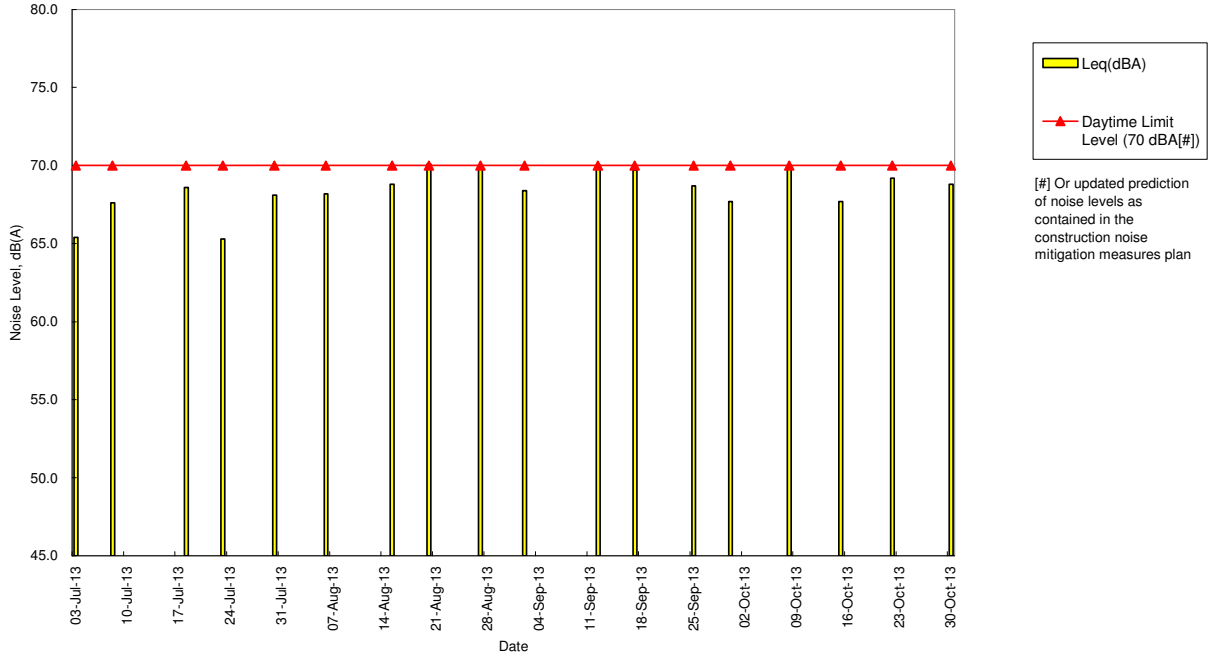

Noise Level at CN2 Holy Spirit Seminary (Educational Institution)

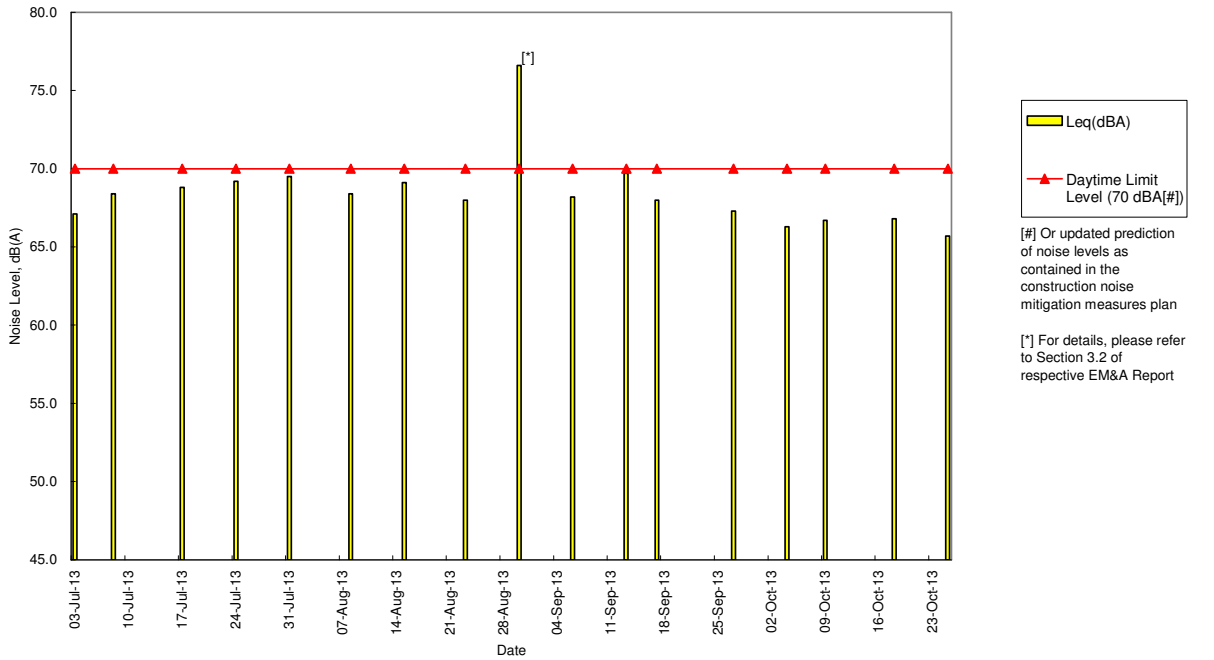

Graphical Plots of Noise Monitoring Results

Noise Level at CN3 Shun Fung Building (Residential)

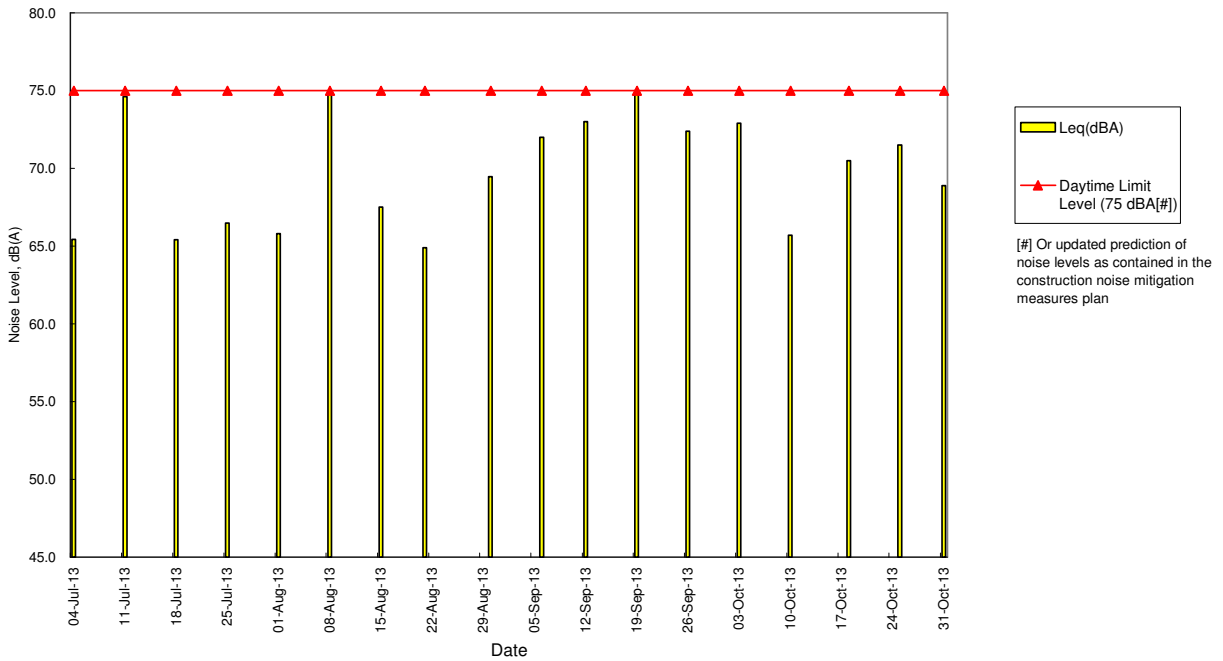

Noise Level at CN4 South Horizons Phase IV – Block 25 Dover Court (Residential)

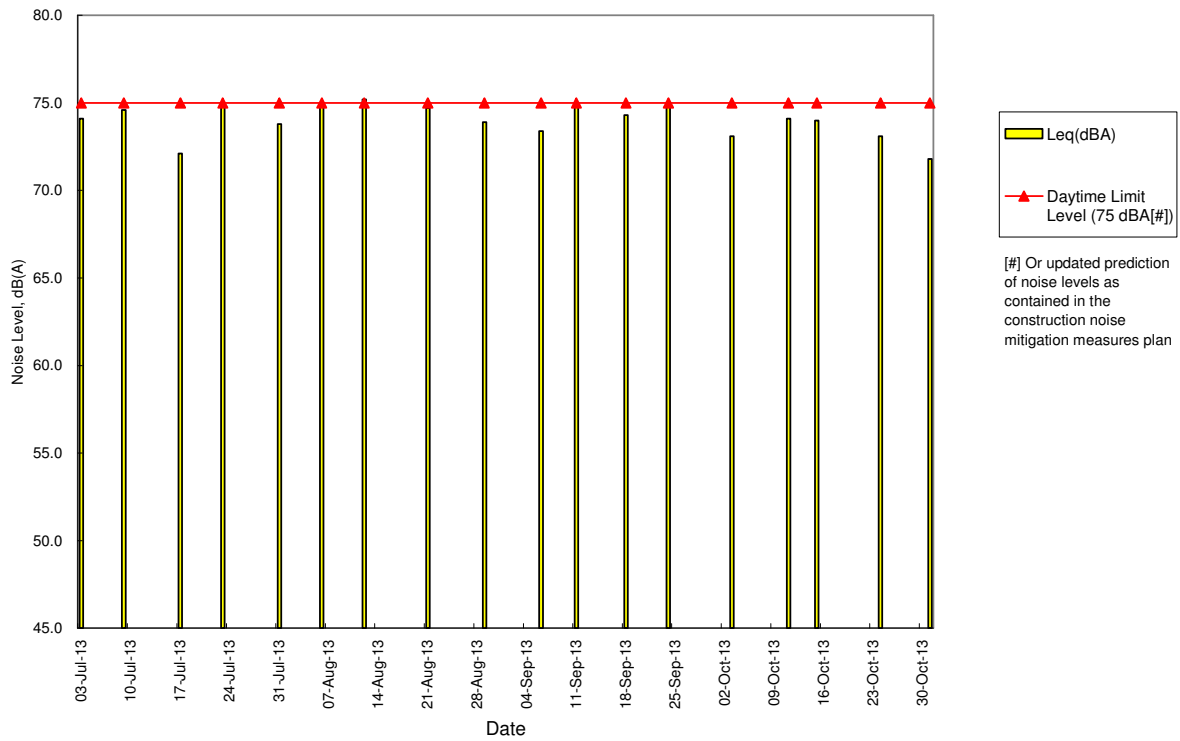

Graphical Plots of Noise Monitoring Results

Noise Level at CN5 TWGHs Jockey Club Rehabilitation Complex Block A (Convalescent Home)

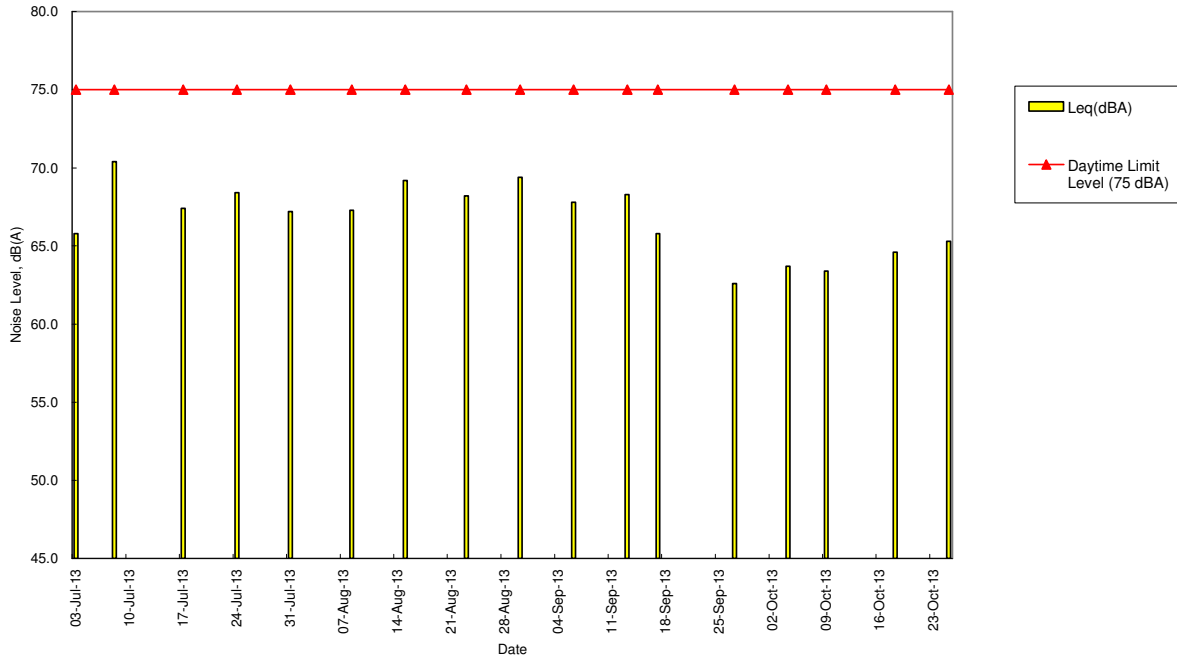

Noise Level at NTB1 Outside Aegean Terrace

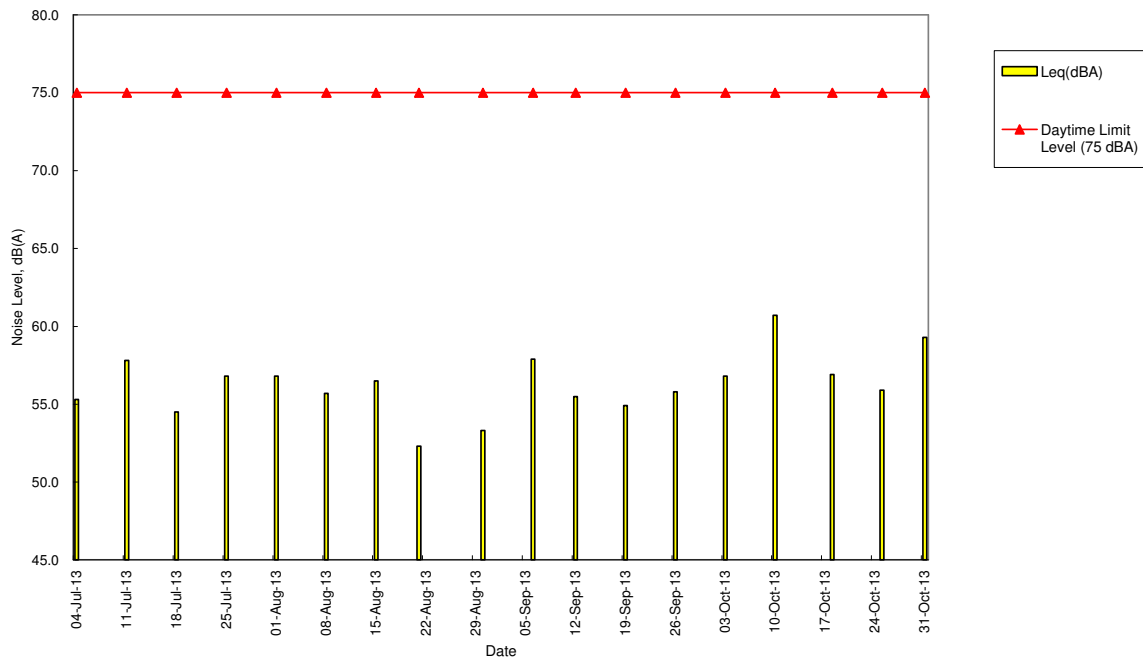

Graphical Plots of Water Quality Monitoring Results

Monitoring Results for Dissolved Oxygen in Flood Tide - Surface Level

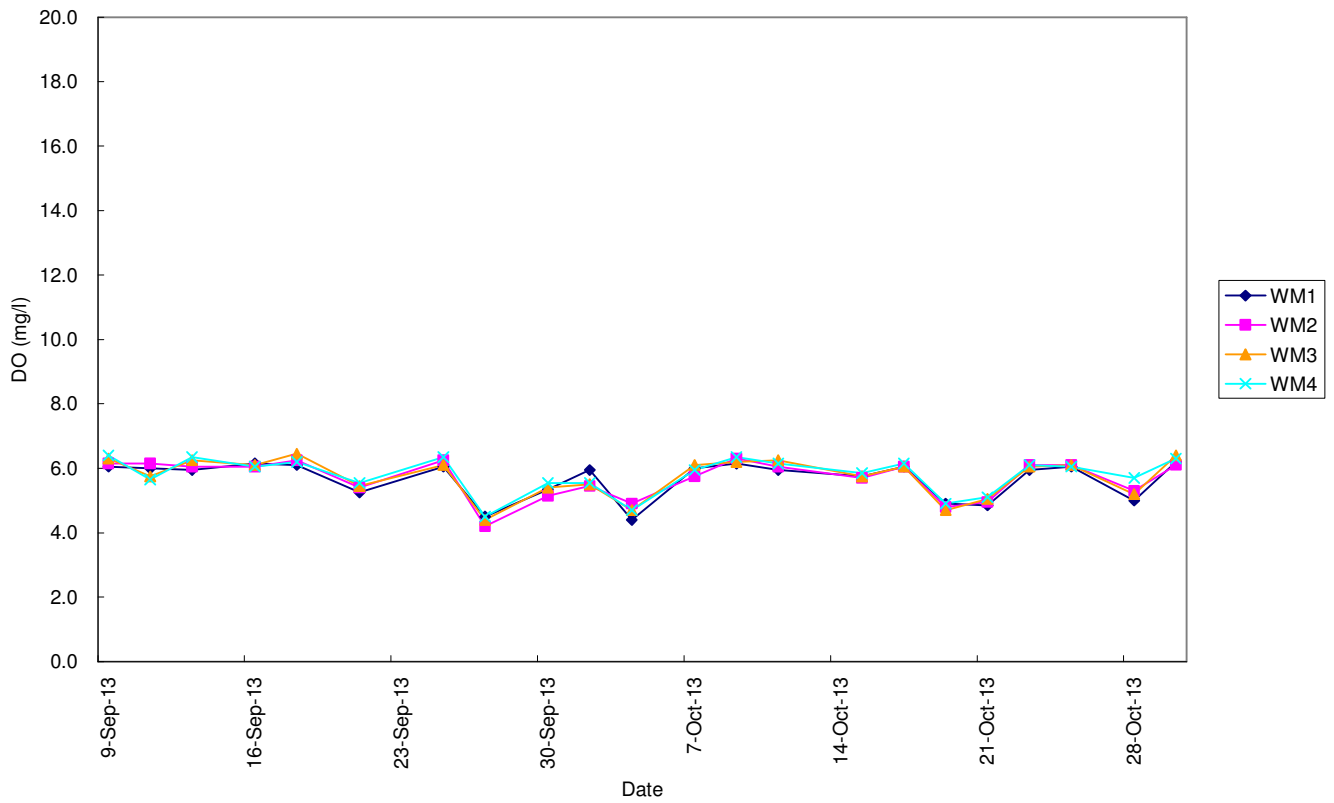

Monitoring Results for Dissolved Oxygen in Flood Tide - Middle Level

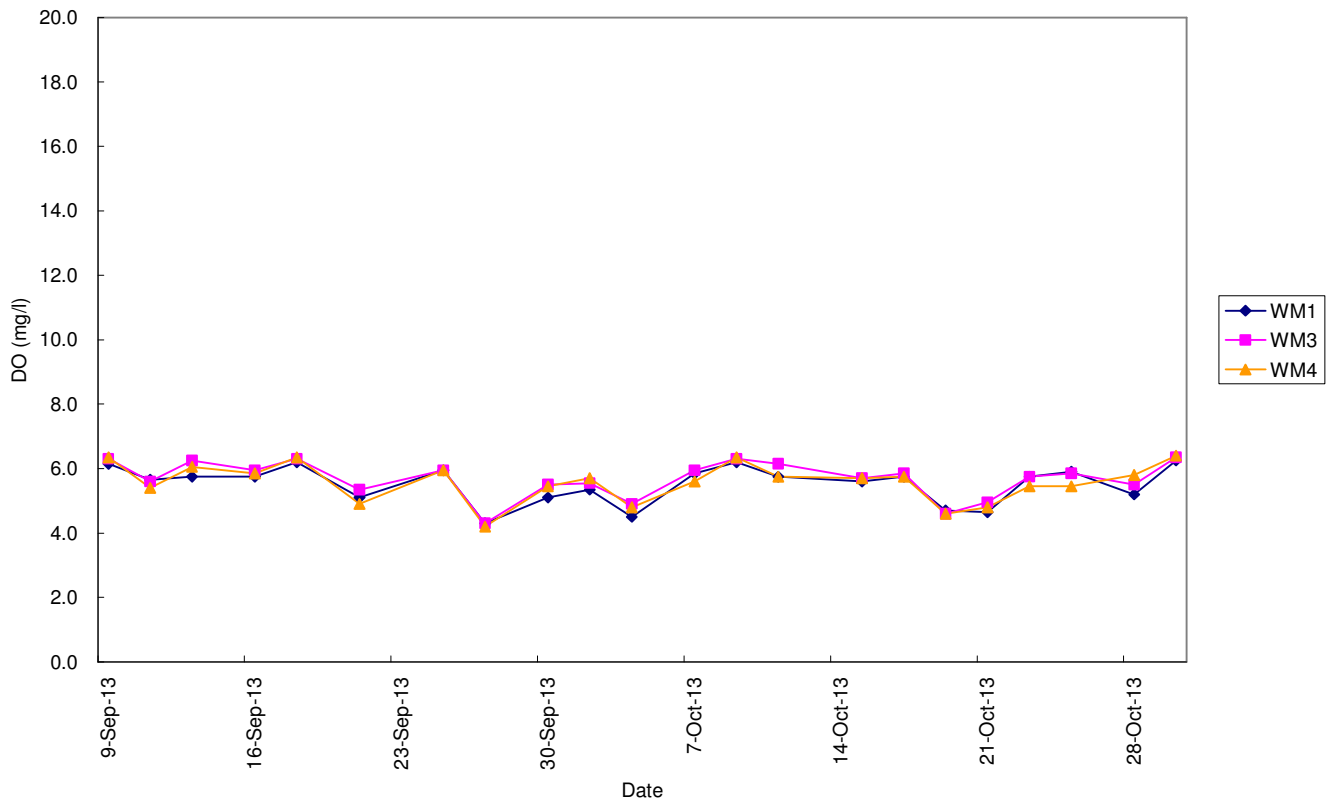

Graphical Plots of Water Quality Monitoring Results

Monitoring Results for Dissolved Oxygen in Flood Tide - Bottom Level

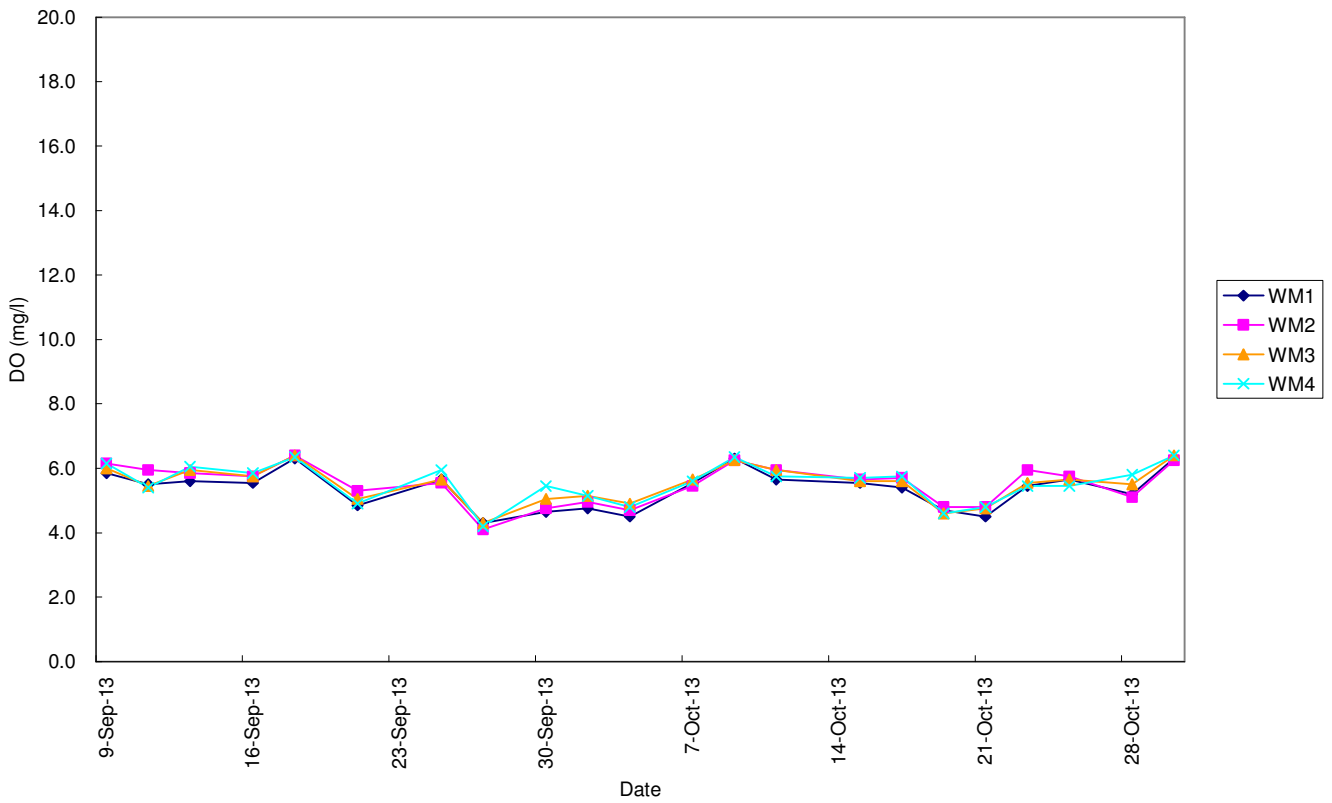

Monitoring Results for Turbidity in Flood Tide - Depth Average

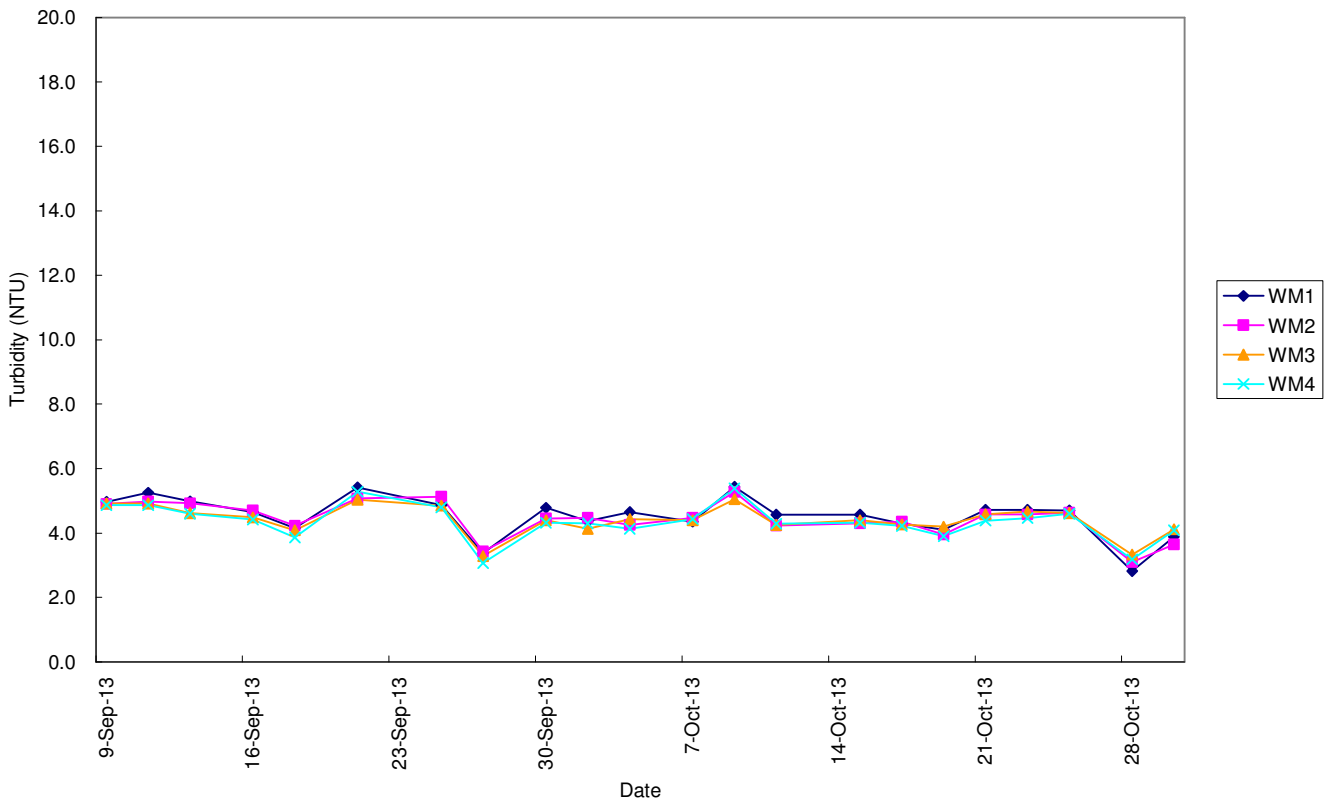

Graphical Plots of Water Quality Monitoring Results

Monitoring Results for Suspended Solids in Flood Tide - Depth Average

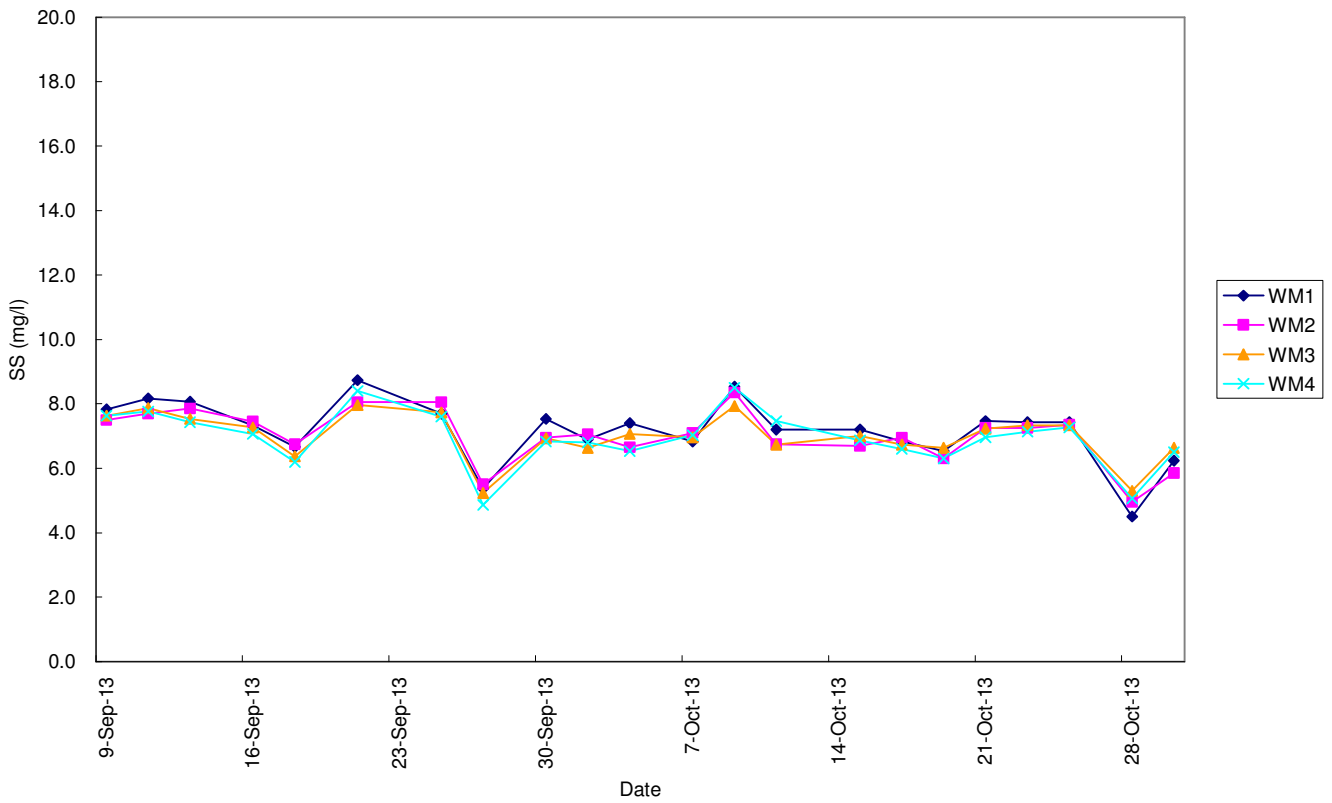

Monitoring Results for Dissolved Oxygen in Ebb Tide - Surface Level

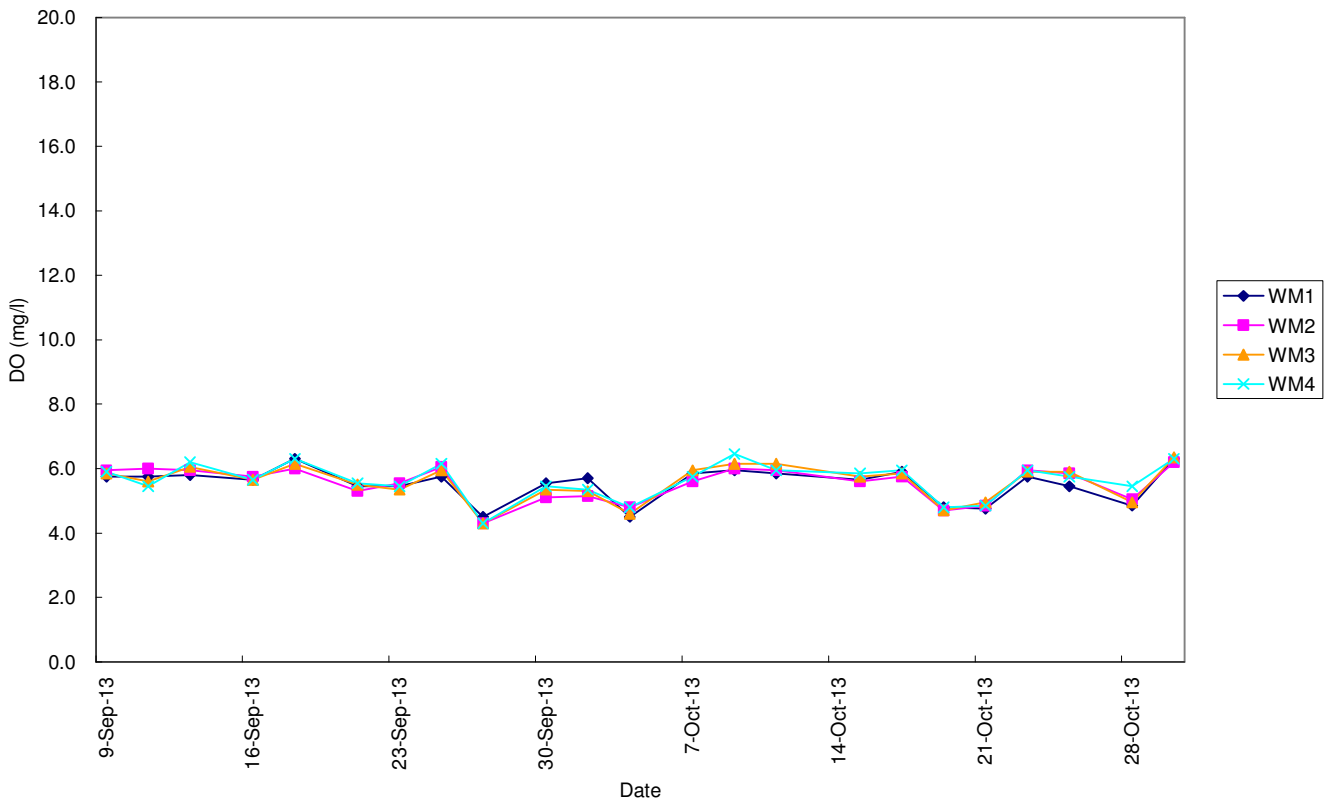

Graphical Plots of Water Quality Monitoring Results

Monitoring Results for Dissolved Oxygen in Ebb Tide - Middle Level

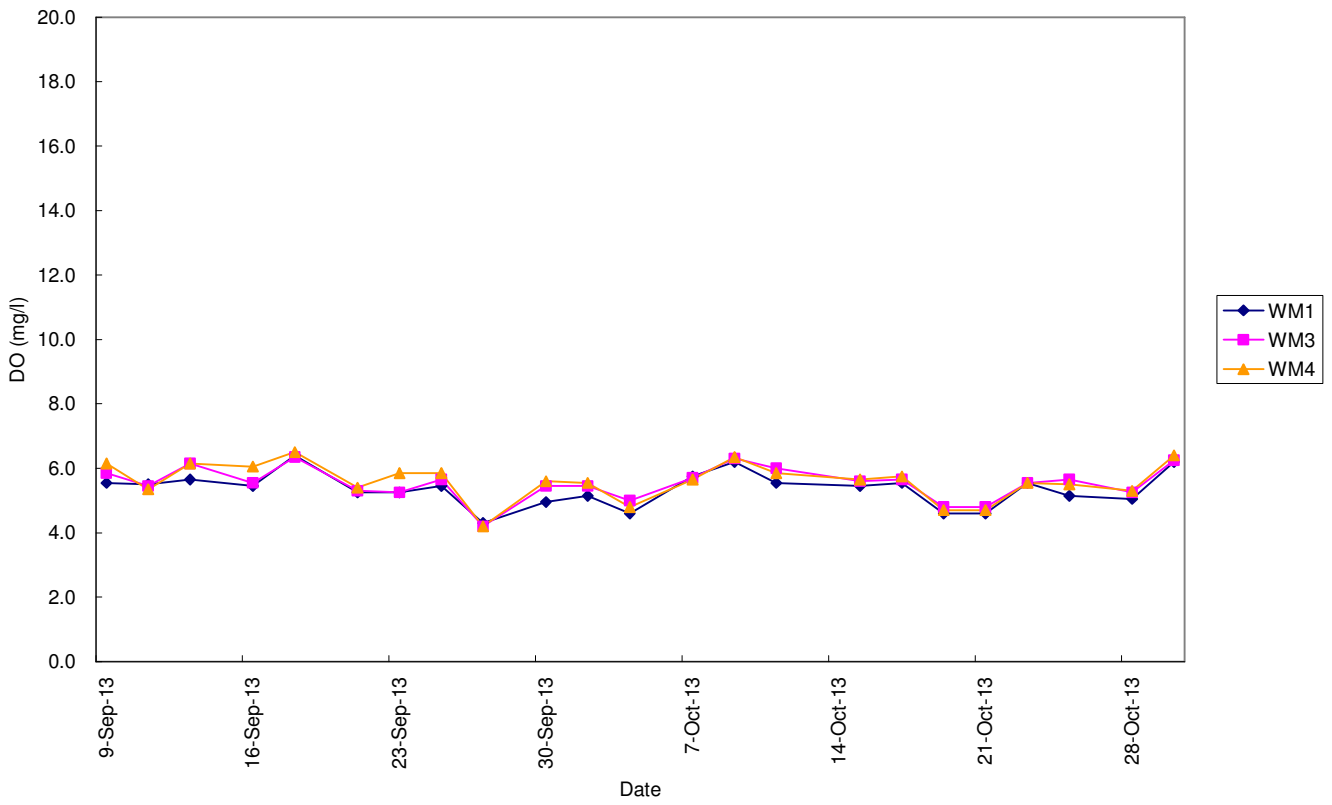

Monitoring Results for Dissolved Oxygen in Ebb Tide - Bottom Level

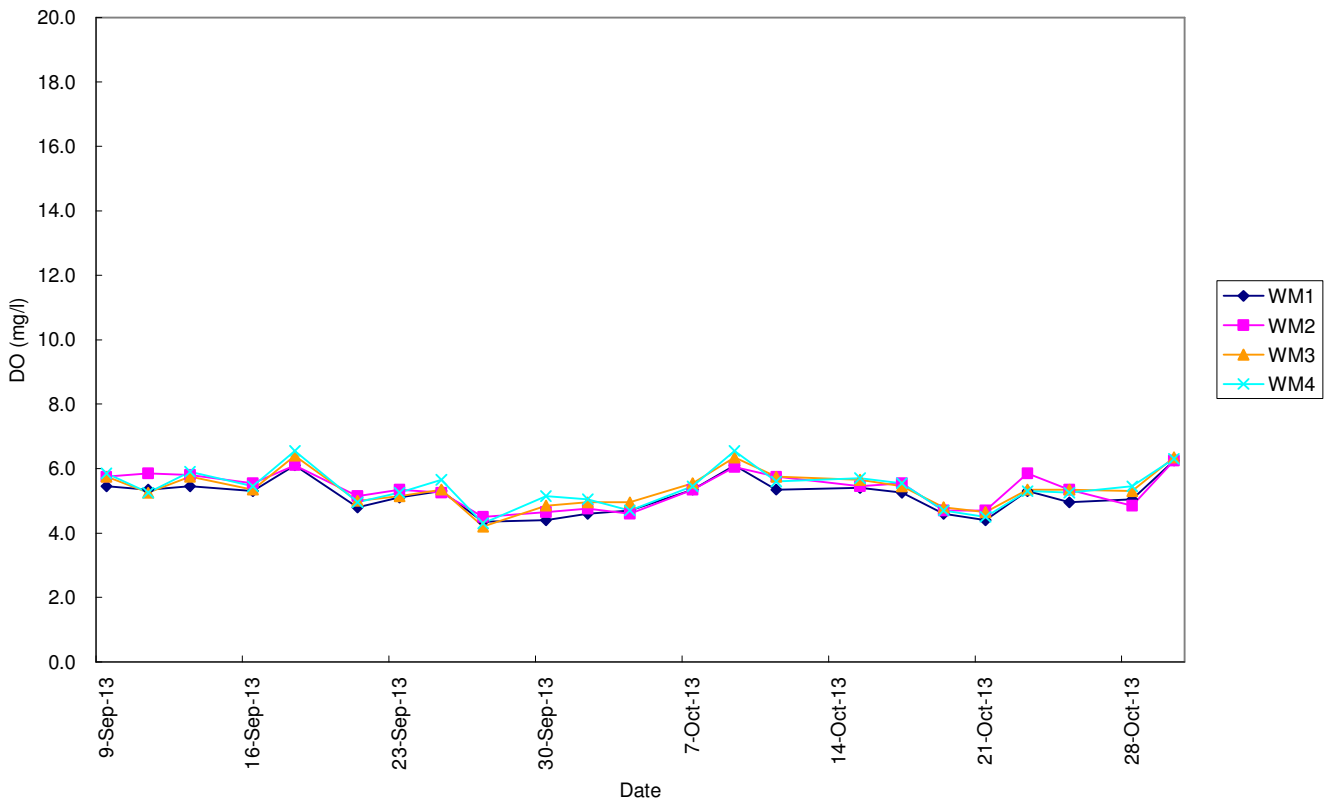

Graphical Plots of Water Quality Monitoring Results

Monitoring Results for Turbidity in Ebb Tide - Depth Average

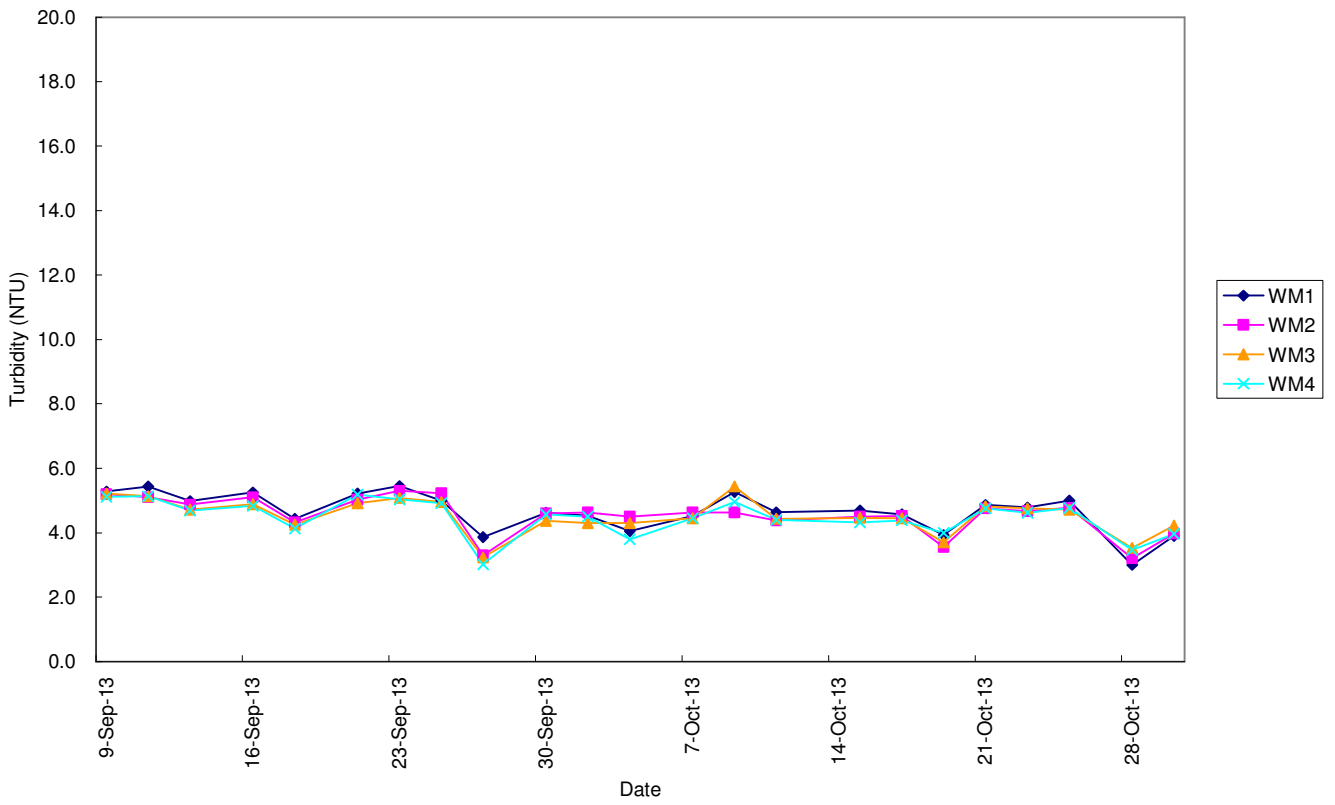

Monitoring Results for Suspended Solids in Ebb Tide - Depth Average

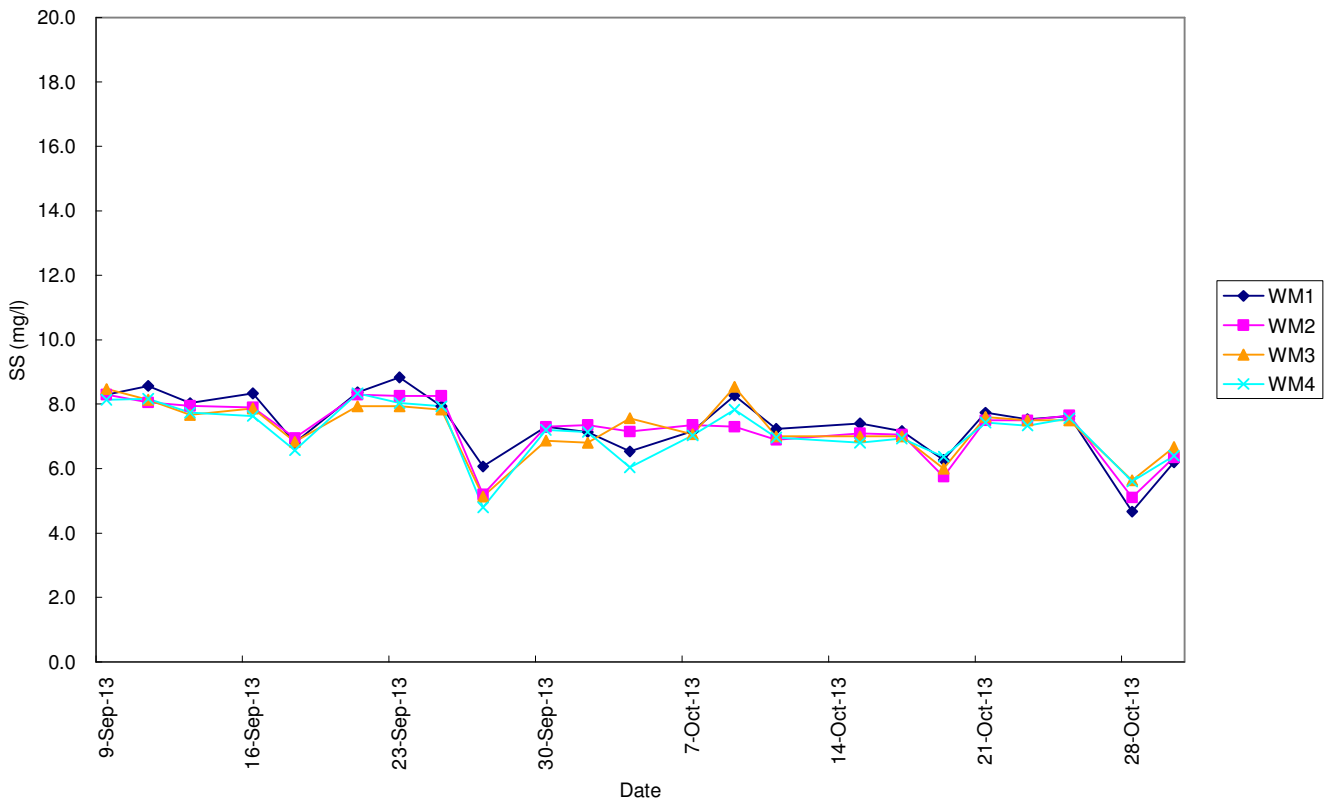

SIL(E) Water Quality Monitoring Data Record Sheet

Date: 2-Oct-13
 Tide: Mid-Flood
 Weather: Fine
 Sea Conditions: Small Wave
 Upstream Control Station CS2

Location	Sampling Time	Water Depth (m)	Monitoring Depth	Temperature (°C)			pH			Salinity (ppt)			DO (mg/l)			DO Saturation (%)			Turbidity (NTU)				Suspended Solids (mg/l)			
				1	2	Ave.*	1	2	Ave.*	1	2	Ave.*	1	2	Ave.*	1	2	Ave.*	1	2	Ave.*	D.A.**	1	2	Ave.*	D.A.**
CS1	1710	11.0	Surface	28.0	27.9	28.0	7.1	7.2	7.2	25.4	25.5	25.5	5.6	5.6	5.6	83.8	83.8	83.8	4.3	4.4	4.4	6.6	7.0	6.8		
			Middle	27.8	27.8	27.8	7.1	7.1	7.1	25.7	25.7	25.7	5.7	5.8	5.8	84.1	85.6	84.9	4.3	4.2	4.3	4.4	6.8	6.8	6.8	6.9
			Bottom	27.7	27.6	27.7	7.2	7.3	7.3	25.9	26.0	26.0	5.4	5.5	5.5	80.4	81.9	81.2	4.5	4.5	4.5		7.2	7.0	7.1	
WM1	1638	13.3	Surface	27.9	28.0	28.0	7.2	7.1	7.2	25.5	25.5	25.5	5.9	6.0	6.0	88.3	89.8	89.1	4.5	4.5	4.5	7.0	7.2	7.1		
			Middle	27.9	27.8	27.9	7.3	7.3	7.3	25.7	25.6	25.7	5.3	5.4	5.4	78.2	79.7	79.0	4.3	4.2	4.3	4.4	6.8	6.6	6.7	6.9
			Bottom	27.7	27.7	27.7	7.2	7.3	7.3	26.0	26.0	26.0	4.7	4.8	4.8	70.0	71.5	70.8	4.4	4.3	4.4		7.0	6.8	6.9	
WM2	1606	5.2	Surface	27.9	27.9	27.9	7.2	7.1	7.2	25.5	25.4	25.5	5.4	5.5	5.5	80.8	82.2	81.5	4.5	4.6	4.6	7.0	7.2	7.1		
			Middle																			4.5				7.1
			Bottom	27.8	27.9	27.9	7.1	7.1	7.1	25.5	25.5	25.5	4.9	5.0	5.0	73.3	74.8	74.1	4.4	4.4	4.4		7.0	7.0	7.0	
WM3	1534	8.5	Surface	28.0	28.0	28.0	7.1	7.2	7.2	25.5	25.4	25.5	5.5	5.5	5.5	82.3	82.3	82.3	4.3	4.2	4.3	6.8	6.8	6.8		
			Middle	27.9	27.8	27.9	7.1	7.1	7.1	25.6	25.7	25.7	5.6	5.5	5.6	82.6	81.1	81.9	4.0	4.0	4.0	4.1	6.4	6.4	6.4	6.6
			Bottom	27.7	27.8	27.8	7.2	7.3	7.3	25.9	25.9	25.9	5.1	5.2	5.2	75.9	77.4	76.7	4.2	4.1	4.2		6.8	6.6	6.7	
WM4	1502	9.7	Surface	27.9	28.0	28.0	7.1	7.2	7.2	25.5	25.5	25.5	5.6	5.5	5.6	83.8	82.4	83.1	4.4	4.4	4.4	6.8	7.0	6.9		
			Middle	27.8	27.8	27.8	7.2	7.2	7.2	25.6	25.7	25.7	5.7	5.7	5.7	84.1	84.1	84.1	4.1	4.0	4.1	4.3	6.4	6.4	6.4	6.8
			Bottom	27.7	27.6	27.7	7.2	7.1	7.2	25.9	26.0	26.0	5.2	5.1	5.2	77.5	75.9	76.7	4.4	4.5	4.5		7.0	7.2	7.1	
CS2	1430	13.5	Surface	28.0	27.9	28.0	7.2	7.2	7.2	25.4	25.5	25.5	5.7	5.7	5.7	85.3	85.3	85.3	4.5	4.6	4.6	7.0	7.2	7.1		
			Middle	27.9	27.8	27.9	7.1	7.2	7.2	25.7	25.7	25.7	5.7	5.8	5.8	84.1	85.6	84.9	4.4	4.4	4.4	4.6	7.0	7.0	7.0	7.3
			Bottom	27.7	27.7	27.7	7.3	7.2	7.3	26.0	25.9	26.0	5.5	5.6	5.6	81.9	83.4	82.7	4.7	4.8	4.8		7.6	7.8	7.7	

Remark or Observation:

Note: * Average

** Depth Average

SIL(E) Water Quality Monitoring Data Record Sheet

Date: 2-Oct-13
 Tide: Mid-Ebb
 Weather: Fine
 Sea Conditions: Small Wave
 Upstream Control Station CS1

Location	Sampling Time	Water Depth (m)	Monitoring Depth	Temperature (°C)			pH			Salinity (ppt)			DO (mg/l)			DO Saturation (%)			Turbidity (NTU)				Suspended Solids (mg/l)			
				1	2	Ave.*	1	2	Ave.*	1	2	Ave.*	1	2	Ave.*	1	2	Ave.*	1	2	Ave.*	D.A.**	1	2	Ave.*	D.A.**
CS1	1000	11.2	Surface	28.0	27.9	28.0	7.1	7.1	7.1	25.5	25.4	25.5	5.4	5.5	5.5	80.8	82.3	81.6	4.7	4.8	4.8	7.4	7.6	7.5		
			Middle	27.8	27.8	27.8	7.2	7.1	7.2	25.8	25.8	25.8	5.6	5.7	5.7	82.7	84.2	83.5	4.5	4.5	4.5	4.6	7.2	7.4	7.3	7.4
			Bottom	27.7	27.6	27.7	7.2	7.3	7.3	26.0	26.1	26.1	5.3	5.3	5.3	79.0	79.0	79.0	4.7	4.6	4.7		7.6	7.4	7.5	
WM1	1032	13.5	Surface	27.9	27.9	27.9	7.2	7.1	7.2	25.5	25.5	25.5	5.7	5.7	5.7	85.3	85.3	85.3	4.6	4.7	4.7	7.2	7.4	7.3		
			Middle	27.9	27.8	27.9	7.1	7.1	7.1	25.5	25.5	25.5	5.1	5.2	5.2	77.1	76.2	76.7	4.4	4.4	4.4	4.5	7.0	7.0	7.0	7.1
			Bottom	27.7	27.6	27.7	7.2	7.3	7.3	25.7	25.6	25.7	4.6	4.6	4.6	68.4	68.5	68.5	4.6	4.5	4.6		7.2	7.0	7.1	
WM2	1104	5.4	Surface	28.0	27.9	28.0	7.2	7.2	7.2	25.4	25.5	25.5	5.2	5.1	5.2	77.8	76.3	77.1	4.7	4.7	4.7	7.4	7.6	7.5		
			Middle																			4.6				7.4
			Bottom	27.9	27.9	27.9	7.1	7.2	7.2	25.4	25.4	25.4	4.8	4.7	4.8	71.4	69.9	70.7	4.5	4.6	4.6		7.0	7.4	7.2	
WM3	1136	8.7	Surface	28.0	27.9	28.0	7.1	7.2	7.2	25.4	25.4	25.4	5.3	5.3	5.3	79.3	79.3	79.3	4.4	4.4	4.4	6.8	7.0	6.9		
			Middle	27.9	27.8	27.9	7.2	7.2	7.2	25.6	25.7	25.7	5.5	5.4	5.5	81.2	79.8	80.5	4.2	4.1	4.2	4.3	6.8	6.4	6.6	6.8
			Bottom	27.7	27.7	27.7	7.1	7.2	7.2	25.9	26.0	26.0	4.9	5.0	5.0	73.0	74.9	74.0	4.3	4.4	4.4		6.8	7.0	6.9	
WM4	1208	9.8	Surface	28.0	28.0	28.0	7.2	7.2	7.2	25.4	25.5	25.5	5.4	5.3	5.4	80.8	79.3	80.1	4.5	4.6	4.6	7.0	7.4	7.2		
			Middle	27.9	27.8	27.9	7.1	7.2	7.2	25.7	25.7	25.7	5.5	5.6	5.6	81.3	82.7	82.0	4.2	4.3	4.3	4.5	6.8	6.6	6.7	7.1
			Bottom	27.8	27.7	27.8	7.1	7.1	7.1	26.0	25.9	26.0	5.1	5.0	5.1	76.0	74.6	75.3	4.7	4.7	4.7		7.6	7.4	7.5	
CS2	1240	13.7	Surface	27.9	28.0	28.0	7.1	7.2	7.2	25.5	25.4	25.5	5.4	5.5	5.5	80.8	82.3	81.6	4.5	4.5	4.5	7.0	7.0	7.0		
			Middle	27.8	27.8	27.8	7.1	7.1	7.1	25.6	25.6	25.6	5.7	5.7	5.7	84.2	84.2	84.2	4.3	4.2	4.3	4.5	6.6	6.6	6.6	7.0
			Bottom	27.7	27.6	27.7	7.2	7.1	7.2	25.9	26.0	26.0	5.3	5.2	5.3	79.0	77.5	78.3	4.8	4.7	4.8		7.6	7.4	7.5	

Remark or Observation:

Note: * Average

** Depth Average

SIL(E) Water Quality Monitoring Data Record Sheet

Date: 4-Oct-13
 Tide: Mid-Flood
 Weather: Cloudy
 Sea Conditions: Small Wave
 Upstream Control Station CS2

Location	Sampling Time	Water Depth (m)	Monitoring Depth	Temperature (°C)			pH			Salinity (ppt)			DO (mg/l)			DO Saturation (%)			Turbidity (NTU)				Suspended Solids (mg/l)							
				1	2	Ave.*	1	2	Ave.*	1	2	Ave.*	1	2	Ave.*	1	2	Ave.*	1	2	Ave.*	D.A.**	1	2	Ave.*	D.A.**				
CS1	1812	11.2	Surface	28.0	28.0	28.0	7.1	7.1	7.1	26.1	26.1	26.1	5.2	5.2	5.2	77.9	77.5	77.7	4.2	4.2	4.2	6.6	6.6	6.6						
			Middle	27.9	27.9	27.9	7.1	7.1	7.1	26.2	26.2	26.2	5.3	5.3	5.3	78.5	78.9	78.7	5.2	5.2	5.2	4.8	8.4	8.2	8.3	7.6				
			Bottom	27.9	27.8	27.9	7.1	7.1	7.1	26.2	26.2	26.2	5.3	5.3	5.3	78.2	78.6	78.4	5.1	5.1	5.1		8.0	8.0	8.0					
WM1	1740	14.2	Surface	27.9	28.0	28.0	7.1	7.1	7.1	26.1	26.1	26.1	4.4	4.4	4.4	66.5	66.7	66.6	4.3	4.4	4.4	6.8	7.0	6.9						
			Middle	28.0	28.0	28.0	7.1	7.1	7.1	26.2	26.2	26.2	4.5	4.5	4.5	67.3	67.6	67.5	4.7	4.7	4.7	4.7	7.6	7.4	7.5	7.4				
			Bottom	27.9	27.9	27.9	7.1	7.1	7.1	26.2	26.2	26.2	4.5	4.5	4.5	67.2	67.5	67.4	4.9	4.9	4.9		7.8	7.8	7.8					
WM2	1712	5.8	Surface	28.0	28.0	28.0	7.1	7.1	7.1	26.1	26.1	26.1	4.9	4.9	4.9	73.2	72.7	73.0	4.0	4.0	4.0	6.2	6.2	6.2						
			Middle																			4.3								6.7
			Bottom	28.0	28.0	28.0	7.1	7.1	7.1	26.1	26.1	26.1	4.7	4.7	4.7	70.4	70.6	70.5	4.5	4.5	4.5		7.2	7.0	7.1					
WM3	1633	9.2	Surface	28.0	28.0	28.0	7.0	7.0	7.0	26.1	26.1	26.1	4.7	4.7	4.7	70.2	70.7	70.5	3.9	3.9	3.9	6.2	6.2	6.2						
			Middle	28.1	28.1	28.1	7.0	7.0	7.0	26.1	26.1	26.1	4.9	4.9	4.9	72.8	72.5	72.7	4.6	4.6	4.6	4.4	7.4	7.2	7.3	7.1				
			Bottom	28.0	28.0	28.0	7.0	7.0	7.0	26.1	26.1	26.1	4.9	4.9	4.9	73.0	72.7	72.9	4.8	4.8	4.8		7.6	7.8	7.7					
WM4	1600	10.8	Surface	28.0	27.9	28.0	7.0	7.0	7.0	26.2	26.2	26.2	4.7	4.7	4.7	70.8	70.4	70.6	3.7	3.7	3.7	5.8	5.8	5.8						
			Middle	27.9	28.0	28.0	7.0	7.0	7.0	26.2	26.2	26.2	4.7	4.7	4.7	70.2	70.6	70.4	4.2	4.2	4.2	4.1	6.6	6.8	6.7	6.5				
			Bottom	27.9	27.9	27.9	7.0	7.0	7.0	26.2	26.2	26.2	4.8	4.8	4.8	71.4	71.1	71.3	4.5	4.5	4.5		7.2	7.0	7.1					
CS2	1530	14.8	Surface	27.9	28.0	28.0	7.0	7.0	7.0	26.3	26.3	26.3	5.4	5.4	5.4	79.7	79.9	79.8	4.4	4.4	4.4	6.8	7.0	6.9						
			Middle	28.0	27.9	28.0	7.0	7.0	7.0	26.2	26.2	26.2	5.5	5.5	5.5	81.1	80.7	80.9	4.9	4.9	4.9	4.8	7.6	7.6	7.6	7.6				
			Bottom	28.0	28.0	28.0	7.0	7.0	7.0	26.2	26.3	26.3	5.5	5.4	5.5	81.4	81.2	81.3	5.2	5.2	5.2		8.4	8.2	8.3					

Remark or Observation:

Note: * Average

** Depth Average

SIL(E) Water Quality Monitoring Data Record Sheet

Date: 4-Oct-13
 Tide: Mid-Ebb
 Weather: Cloudy
 Sea Conditions: Small Wave
 Upstream Control Station CS1

Location	Sampling Time	Water Depth (m)	Monitoring Depth	Temperature (°C)			pH			Salinity (ppt)			DO (mg/l)			DO Saturation (%)			Turbidity (NTU)				Suspended Solids (mg/l)							
				1	2	Ave.*	1	2	Ave.*	1	2	Ave.*	1	2	Ave.*	1	2	Ave.*	1	2	Ave.*	D.A.**	1	2	Ave.*	D.A.**				
CS1	1100	10.2	Surface	27.9	27.9	27.9	7.0	7.0	7.0	25.8	25.8	25.8	5.3	5.3	5.3	78.9	79.4	79.2	4.6	4.6	4.6	7.2	7.2	7.2						
			Middle	27.9	27.9	27.9	7.0	7.0	7.0	26.0	26.0	26.0	5.2	5.2	5.2	77.8	77.4	77.6	5.9	5.9	5.9	5.5	9.2	9.4	9.3	8.6				
			Bottom	27.8	27.8	27.8	7.0	7.0	7.0	26.1	26.1	26.1	5.4	5.4	5.4	79.7	79.2	79.5	6.0	6.0	6.0		9.4	9.4	9.4					
WM1	1130	13.2	Surface	27.8	27.8	27.8	7.0	7.0	7.0	26.0	26.0	26.0	4.5	4.5	4.5	67.3	67.7	67.5	3.7	3.7	3.7	5.8	6.2	6.0						
			Middle	27.9	27.9	27.9	7.0	7.0	7.0	26.0	26.0	26.0	4.6	4.6	4.6	68.2	67.7	68.0	4.1	4.1	4.1	4.1	6.4	6.8	6.6	6.5				
			Bottom	27.9	27.9	27.9	7.0	7.0	7.0	26.0	26.0	26.0	4.7	4.7	4.7	69.5	69.1	69.3	4.3	4.4	4.4		7.0	7.0	7.0					
WM2	1205	5.2	Surface	27.8	27.9	27.9	7.0	7.0	7.0	26.0	26.0	26.0	4.8	4.8	4.8	71.3	71.7	71.5	3.9	3.9	3.9	6.2	6.2	6.2						
			Middle																		4.5								7.2	
			Bottom	27.9	27.9	27.9	7.1	7.1	7.1	26.0	26.0	26.0	4.6	4.6	4.6	68.9	68.5	68.7	5.1	5.1	5.1		8.0	8.2	8.1					
WM3	1233	8.4	Surface	27.9	27.9	27.9	7.0	7.0	7.0	26.0	26.0	26.0	4.6	4.6	4.6	69.5	69.8	69.7	3.3	3.3	3.3	7.6	7.8	7.7						
			Middle	27.9	27.9	27.9	7.1	7.1	7.1	26.0	26.0	26.0	5.0	5.0	5.0	75.0	75.3	75.2	4.7	4.7	4.7	4.3	7.4	7.4	7.4	7.6				
			Bottom	27.9	27.9	27.9	7.1	7.1	7.1	26.1	26.1	26.1	5.0	4.9	5.0	73.7	73.0	73.4	4.9	4.9	4.9		7.6	7.6	7.6					
WM4	1307	10.2	Surface	27.8	27.8	27.8	7.1	7.1	7.1	26.1	26.1	26.1	4.8	4.8	4.8	71.0	71.4	71.2	3.2	3.2	3.2	5.0	5.0	5.0						
			Middle	27.9	27.9	27.9	7.1	7.1	7.1	26.1	26.1	26.1	4.8	4.8	4.8	71.8	71.5	71.7	3.8	3.8	3.8	3.8	6.0	6.0	6.0	6.0				
			Bottom	27.8	27.8	27.8	7.1	7.1	7.1	26.1	26.1	26.1	4.7	4.7	4.7	70.0	70.4	70.2	4.4	4.4	4.4		7.2	7.0	7.1					
CS2	1340	14.4	Surface	27.8	27.8	27.8	7.1	7.1	7.1	26.2	26.2	26.2	5.3	5.3	5.3	78.4	78.7	78.6	3.8	3.8	3.8	6.0	6.0	6.0						
			Middle	27.8	27.8	27.8	7.1	7.1	7.1	26.2	26.1	26.2	5.4	5.4	5.4	79.4	79.2	79.3	4.0	4.0	4.0	4.2	6.2	6.4	6.3	6.7				
			Bottom	27.8	27.8	27.8	7.1	7.1	7.1	26.2	26.2	26.2	5.4	5.4	5.4	80.1	79.6	79.9	4.9	4.9	4.9		7.6	7.8	7.7					

Remark or Observation:

Note: * Average

** Depth Average

SIL(E) Water Quality Monitoring Data Record Sheet

Date: 7-Oct-13
 Tide: Mid-Flood
 Weather: Fine
 Sea Conditions: Small Wave
 Upstream Control Station CS2

Location	Sampling Time	Water Depth (m)	Monitoring Depth	Temperature (°C)			pH			Salinity (ppt)			DO (mg/l)			DO Saturation (%)			Turbidity (NTU)				Suspended Solids (mg/l)			
				1	2	Ave.*	1	2	Ave.*	1	2	Ave.*	1	2	Ave.*	1	2	Ave.*	1	2	Ave.*	D.A.**	1	2	Ave.*	D.A.**
CS1	1010	11.4	Surface	27.8	27.8	27.8	7.1	7.1	7.1	25.5	25.5	25.5	5.4	5.5	5.5	80.6	82.1	81.4	4.4	4.4	4.4	6.8	7.0	6.9		
			Middle	27.6	27.7	27.7	7.2	7.1	7.2	25.6	25.7	25.7	5.6	5.6	5.6	83.4	83.5	83.5	4.2	4.3	4.3	4.4	6.6	6.6	6.6	6.8
			Bottom	27.5	27.5	27.5	7.2	7.2	7.2	25.9	26.0	26.0	5.3	5.2	5.3	79.0	77.5	78.3	4.4	4.5	4.5		7.0	7.0	7.0	
WM1	0934	13.9	Surface	27.8	27.7	27.8	7.2	7.1	7.2	25.3	25.4	25.4	6.0	6.0	6.0	89.6	89.6	89.6	4.3	4.4	4.4	6.6	7.0	6.8		
			Middle	27.6	27.6	27.6	7.1	7.1	7.1	25.5	25.6	25.6	5.9	5.8	5.9	87.8	86.4	87.1	4.3	4.2	4.3	4.4	6.8	6.6	6.7	6.8
			Bottom	27.5	27.6	27.6	7.3	7.2	7.3	25.8	25.8	25.8	5.6	5.5	5.6	83.4	82.0	82.7	4.5	4.4	4.5		7.0	7.0	7.0	
WM2	0904	5.6	Surface	27.7	27.7	27.7	7.1	7.2	7.2	25.4	25.4	25.4	5.7	5.8	5.8	85.1	86.6	85.9	4.5	4.5	4.5	7.0	7.2	7.1		
			Middle																			4.5				7.1
			Bottom	27.6	27.7	27.7	7.2	7.2	7.2	25.5	25.5	25.5	5.5	5.4	5.5	82.1	80.5	81.3	4.4	4.5	4.5		7.0	7.2	7.1	
WM3	0832	9.3	Surface	27.7	27.8	27.8	7.1	7.2	7.2	25.4	25.3	25.4	6.1	6.1	6.1	91.1	91.1	91.1	4.2	4.3	4.3	6.6	6.8	6.7		
			Middle	27.6	27.7	27.7	7.1	7.1	7.1	25.6	25.6	25.6	5.9	6.0	6.0	87.8	89.3	88.6	4.3	4.4	4.4	4.4	6.8	7.0	6.9	7.0
			Bottom	27.5	27.6	27.6	7.3	7.2	7.3	25.9	25.8	25.9	5.7	5.6	5.7	85.0	83.6	84.3	4.6	4.6	4.6		7.2	7.4	7.3	
WM4	0800	10.1	Surface	27.7	27.7	27.7	7.1	7.1	7.1	25.4	25.4	25.4	5.9	6.0	6.0	88.1	89.6	88.9	4.3	4.4	4.4	6.8	7.0	6.9		
			Middle	27.6	27.7	27.7	7.3	7.2	7.3	25.6	25.5	25.6	5.8	5.9	5.9	86.3	87.7	87.0	4.4	4.4	4.4	4.4	7.0	7.0	7.0	7.0
			Bottom	27.5	27.5	27.5	7.2	7.2	7.2	25.9	25.8	25.9	5.6	5.6	5.6	83.5	83.6	83.6	4.6	4.5	4.6		7.2	7.2	7.2	
CS2	0730	13.7	Surface	27.8	27.7	27.8	7.1	7.2	7.2	25.5	25.5	25.5	5.5	5.6	5.6	82.1	83.6	82.9	4.5	4.6	4.6	7.0	7.2	7.1		
			Middle	27.7	27.7	27.7	7.2	7.1	7.2	25.7	25.6	25.7	5.3	5.3	5.3	78.9	78.8	78.9	4.4	4.4	4.4	4.6	7.0	7.2	7.1	7.3
			Bottom	27.6	27.7	27.7	7.2	7.2	7.2	25.9	26.0	26.0	5.2	5.3	5.3	77.6	79.1	78.4	4.7	4.8	4.8		7.6	7.6	7.6	

Remark or Observation:

Note: * Average

** Depth Average

SIL(E) Water Quality Monitoring Data Record Sheet

Date: 7-Oct-13
 Tide: Mid-Ebb
 Weather: Fine
 Sea Conditions: Small Wave
 Upstream Control Station CS1

Location	Sampling Time	Water Depth (m)	Monitoring Depth	Temperature (°C)			pH			Salinity (ppt)			DO (mg/l)			DO Saturation (%)			Turbidity (NTU)				Suspended Solids (mg/l)			
				1	2	Ave.*	1	2	Ave.*	1	2	Ave.*	1	2	Ave.*	1	2	Ave.*	1	2	Ave.*	D.A.**	1	2	Ave.*	D.A.**
CS1	1200	11.2	Surface	27.7	27.8	27.8	7.1	7.2	7.2	25.4	25.5	25.5	5.3	5.4	5.4	79.1	80.6	79.9	4.6	4.7	4.7	7.2	7.6	7.4		
			Middle	27.7	27.7	27.7	7.1	7.1	7.1	25.7	25.6	25.7	5.5	5.5	5.5	81.9	81.9	81.9	4.7	4.8	4.8	4.7	7.4	7.6	7.5	7.5
			Bottom	27.5	27.6	27.6	7.2	7.3	7.3	25.9	26.0	26.0	5.1	5.0	5.1	76.1	74.6	75.4	4.8	4.8	4.8		7.8	7.6	7.7	
WM1	1232	13.7	Surface	27.7	27.7	27.7	7.2	7.1	7.2	25.4	25.3	25.4	5.8	5.9	5.9	86.6	88.1	87.4	4.5	4.5	4.5		7.0	7.2	7.1	
			Middle	27.6	27.7	27.7	7.1	7.2	7.2	25.6	25.6	25.6	5.7	5.8	5.8	84.8	86.4	85.6	4.4	4.5	4.5	4.5	7.0	7.2	7.1	7.2
			Bottom	27.5	27.5	27.5	7.2	7.2	7.2	25.8	25.9	25.9	5.4	5.3	5.4	80.6	79.1	79.9	4.6	4.6	4.6		7.2	7.4	7.3	
WM2	1305	5.4	Surface	27.8	27.7	27.8	7.2	7.1	7.2	25.3	25.4	25.4	5.6	5.6	5.6	83.6	83.6	83.6	4.6	4.7	4.7		7.4	7.4	7.4	
			Middle																			4.6				7.4
			Bottom	27.6	27.7	27.7	7.3	7.2	7.3	25.4	25.4	25.4	5.4	5.3	5.4	80.5	79.0	79.8	4.6	4.6	4.6		7.2	7.4	7.3	
WM3	1337	9.1	Surface	27.8	27.8	27.8	7.1	7.2	7.2	25.4	25.4	25.4	5.9	6.0	6.0	88.1	89.5	88.8	4.3	4.4	4.4		6.8	6.8	6.8	
			Middle	27.7	27.6	27.7	7.1	7.1	7.1	25.5	25.6	25.6	5.7	5.7	5.7	84.9	84.8	84.9	4.4	4.5	4.5	4.5	7.0	7.2	7.1	7.1
			Bottom	27.5	27.5	27.5	7.3	7.2	7.3	25.8	25.9	25.9	5.5	5.6	5.6	82.1	83.6	82.9	4.5	4.6	4.6		7.2	7.4	7.3	
WM4	1408	9.8	Surface	27.7	27.8	27.8	7.2	7.1	7.2	25.3	25.4	25.4	5.7	5.8	5.8	85.1	86.5	85.8	4.4	4.4	4.4		6.8	7.0	6.9	
			Middle	27.6	27.6	27.6	7.2	7.2	7.2	25.5	25.5	25.5	5.6	5.7	5.7	83.4	84.9	84.2	4.5	4.4	4.5	4.5	7.0	7.2	7.1	7.0
			Bottom	27.5	27.6	27.6	7.1	7.2	7.2	25.9	25.8	25.9	5.4	5.5	5.5	80.6	82.1	81.4	4.5	4.5	4.5		7.2	7.0	7.1	
CS2	1440	13.5	Surface	27.8	27.8	27.8	7.3	7.2	7.3	25.4	25.5	25.5	5.4	5.5	5.5	80.6	82.1	81.4	4.4	4.5	4.5		7.0	7.2	7.1	
			Middle	27.6	27.7	27.7	7.1	7.2	7.2	25.6	25.7	25.7	5.3	5.2	5.3	78.9	77.4	78.2	4.4	4.4	4.4	4.5	6.8	7.2	7.0	7.1
			Bottom	27.6	27.6	27.6	7.2	7.1	7.2	25.9	25.9	25.9	5.1	5.1	5.1	76.1	76.1	76.1	4.5	4.5	4.5		7.4	7.2	7.3	

Remark or Observation:

Note: * Average

** Depth Average

SIL(E) Water Quality Monitoring Data Record Sheet

Date: 9-Oct-13
 Tide: Mid-Flood
 Weather: Fine
 Sea Conditions: Small Wave
 Upstream Control Station CS2

Location	Sampling Time	Water Depth (m)	Monitoring Depth	Temperature (°C)			pH			Salinity (ppt)			DO (mg/l)			DO Saturation (%)			Turbidity (NTU)				Suspended Solids (mg/l)							
				1	2	Ave.*	1	2	Ave.*	1	2	Ave.*	1	2	Ave.*	1	2	Ave.*	1	2	Ave.*	D.A.**	1	2	Ave.*	D.A.**				
CS1	1139	12.0	Surface	27.5	27.5	27.5	6.9	6.9	6.9	26.3	26.3	26.3	5.4	5.4	5.4	79.3	79.7	79.5	5.6	5.6	5.6	8.8	8.8	8.8						
			Middle	27.5	27.5	27.5	7.0	7.0	7.0	26.4	26.5	26.5	5.7	5.7	5.7	83.7	83.8	83.8	5.2	5.1	5.2	5.3	8.2	8.0	8.1	8.3				
			Bottom	27.4	27.5	27.5	6.9	7.0	7.0	26.7	26.7	26.7	5.3	5.3	5.3	77.9	77.1	77.5	5.0	5.1	5.1		8.0	8.2	8.1					
WM1	1058	13.6	Surface	2.8	2.8	2.8	7.0	7.0	7.0	26.2	26.2	26.2	6.2	6.1	6.2	91.1	89.6	90.4	5.4	5.4	5.4	8.4	8.4	8.4						
			Middle	27.5	27.5	27.5	7.1	7.1	7.1	26.3	26.4	26.4	6.2	6.2	6.2	91.1	91.3	91.2	5.6	5.5	5.6	5.4	8.8	8.8	8.8	8.5				
			Bottom	27.5	27.5	27.5	7.0	7.0	7.0	26.7	26.6	26.7	6.3	6.3	6.3	92.5	92.1	92.3	5.4	5.3	5.4		8.6	8.2	8.4					
WM2	1028	15.8	Surface	27.6	27.6	27.6	7.1	7.0	7.1	26.3	26.3	26.3	6.3	6.3	6.3	82.5	82.3	82.4	5.6	5.5	5.6	8.8	8.6	8.7						
			Middle																			5.3							8.4	
			Bottom	27.5	27.5	27.5	7.0	7.1	7.1	26.5	26.5	26.5	6.2	6.3	6.3	91.6	92.0	91.8	5.0	5.0	5.0		7.8	8.2	8.0					
WM3	0959	9.8	Surface	27.5	27.6	27.6	6.8	6.9	6.9	26.4	26.3	26.4	6.2	6.2	6.2	91.7	91.3	91.5	4.9	4.8	4.9	7.6	7.4	7.5						
			Middle	27.5	27.5	27.5	7.0	7.1	7.1	26.5	26.5	26.5	6.3	6.3	6.3	92.9	92.7	92.8	5.2	5.2	5.2	5.1	8.2	8.2	8.2	7.9				
			Bottom	27.4	27.5	27.5	7.2	7.1	7.2	26.7	26.7	26.7	6.2	6.3	6.3	91.0	91.9	91.5	5.1	5.1	5.1		8.0	8.2	8.1					
WM4	0928	10.6	Surface	27.6	27.6	27.6	6.9	6.9	6.9	26.4	26.4	26.4	6.3	6.4	6.4	92.8	93.0	92.9	5.1	5.2	5.2	8.0	8.2	8.1						
			Middle	27.5	27.6	27.6	7.0	7.0	7.0	26.4	26.5	26.5	6.3	6.3	6.3	92.4	92.6	92.5	5.3	5.3	5.3	5.4	8.4	8.2	8.3	8.5				
			Bottom	27.5	27.5	27.5	7.1	7.1	7.1	26.6	26.7	26.7	6.4	6.3	6.4	93.9	93.0	93.5	5.7	5.7	5.7		9.0	9.2	9.1					
CS2	0900	15.0	Surface	27.5	27.6	27.6	7.1	7.0	7.1	26.3	26.4	26.4	6.2	6.1	6.2	91.5	90.8	91.2	5.3	5.3	5.3	8.2	8.2	8.2						
			Middle	27.5	27.5	27.5	7.1	7.1	7.1	26.6	26.6	26.6	6.1	6.1	6.1	89.6	90.0	89.8	5.5	5.6	5.6	5.4	8.6	8.8	8.7	8.5				
			Bottom	27.4	27.4	27.4	7.0	7.0	7.0	26.7	26.7	26.7	6.0	6.0	6.0	88.1	88.9	88.5	5.2	5.3	5.3		8.4	8.6	8.5					

Remark or Observation:

Note: * Average

** Depth Average

SIL(E) Water Quality Monitoring Data Record Sheet

Date: 9-Oct-13
 Tide: Mid-Ebb
 Weather: Fine
 Sea Conditions: Calm
 Upstream Control Station CS1

Location	Sampling Time	Water Depth (m)	Monitoring Depth	Temperature (°C)			pH			Salinity (ppt)			DO (mg/l)			DO Saturation (%)			Turbidity (NTU)				Suspended Solids (mg/l)			
				1	2	Ave.*	1	2	Ave.*	1	2	Ave.*	1	2	Ave.*	1	2	Ave.*	1	2	Ave.*	D.A.**	1	2	Ave.*	D.A.**
CS1	1330	11.6	Surface	27.6	27.5	27.6	6.9	6.9	6.9	26.2	26.3	26.3	5.1	5.1	5.1	75.5	75.8	75.7	5.1	5.2	5.2	8.0	8.2	8.1		
			Middle	27.5	27.4	27.5	7.0	7.0	7.0	26.5	26.5	26.5	5.4	5.4	5.4	79.3	79.7	79.5	5.7	5.7	5.7	5.6	9.0	8.8	8.9	8.8
			Bottom	27.4	27.4	27.4	7.0	7.0	7.0	26.5	26.6	26.6	5.5	5.5	5.5	80.8	80.2	80.5	5.9	5.9	5.9		9.2	9.4	9.3	
WM1	1402	13.0	Surface	27.7	27.6	27.7	7.0	7.0	7.0	26.4	26.3	26.4	5.9	6.0	6.0	86.6	88.1	87.4	5.0	5.1	5.1	7.8	8.0	7.9		
			Middle	27.5	27.6	27.6	7.1	7.1	7.1	26.5	26.5	26.5	6.2	6.2	6.2	91.1	91.7	91.4	5.2	5.3	5.3	5.3	8.4	8.2	8.3	8.3
			Bottom	27.5	27.5	27.5	7.1	7.1	7.1	26.4	26.5	26.5	6.1	6.1	6.1	89.6	89.8	89.7	5.5	5.5	5.5		8.6	8.6	8.6	
WM2	1436	5.2	Surface	27.6	27.6	27.6	7.0	7.1	7.1	26.3	26.2	26.3	6.0	6.0	6.0	88.1	88.3	88.2	4.9	4.9	4.9	7.6	7.6	7.6		
			Middle																			4.6				7.3
			Bottom	27.6	27.5	27.6	7.1	7.1	7.1	26.3	26.3	26.3	6.1	6.0	6.1	89.6	88.1	88.9	4.3	4.4	4.4		6.8	7.2	7.0	
WM3	1510	9.2	Surface	27.6	27.6	27.6	6.8	6.9	6.9	26.3	26.4	26.4	6.2	6.1	6.2	91.1	89.6	90.4	5.0	5.1	5.1	7.8	8.0	7.9		
			Middle	27.5	27.6	27.6	6.9	6.9	6.9	26.5	26.5	26.5	6.3	6.3	6.3	92.5	92.8	92.7	5.4	5.5	5.5	5.4	8.4	8.6	8.5	8.5
			Bottom	27.5	27.5	27.5	7.0	7.0	7.0	26.5	26.5	26.5	6.4	6.3	6.4	94.0	92.5	93.3	5.8	5.8	5.8		9.4	9.0	9.2	
WM4	1542	10.0	Surface	27.7	27.7	27.7	6.9	6.9	6.9	26.3	26.3	26.3	6.4	6.5	6.5	94.0	95.5	94.8	4.6	4.7	4.7	7.2	7.4	7.3		
			Middle	27.6	27.6	27.6	7.1	7.1	7.1	26.4	26.5	26.5	6.3	6.4	6.4	92.5	94.0	93.3	4.8	4.9	4.9	5.0	7.6	7.8	7.7	7.8
			Bottom	27.6	27.5	27.6	7.1	7.0	7.1	26.6	26.7	26.7	6.6	6.5	6.6	96.9	95.5	96.2	5.3	5.4	5.4		8.4	8.6	8.5	
CS2	1609	14.6	Surface	27.6	27.7	27.7	6.9	7.0	7.0	26.4	26.4	26.4	6.3	6.3	6.3	92.5	92.4	92.5	4.9	4.9	4.9	7.6	7.8	7.7		
			Middle	27.6	27.6	27.6	7.0	7.0	7.0	26.3	26.4	26.4	6.0	6.0	6.0	88.1	88.9	88.5	5.8	5.8	5.8	5.5	9.2	9.0	9.1	8.7
			Bottom	27.4	27.5	27.4	7.0	7.1	7.1	26.7	26.7	26.7	6.1	6.1	6.1	89.7	89.3	89.5	5.9	5.9	5.9		9.4	9.2	9.3	

Remark or Observation:

Note: * Average

** Depth Average

SIL(E) Water Quality Monitoring Data Record Sheet

Date: 11-Oct-13
 Tide: Mid-Flood
 Weather: Fine
 Sea Conditions: Small Wave
 Upstream Control Station CS2

Location	Sampling Time	Water Depth (m)	Monitoring Depth	Temperature (°C)			pH			Salinity (ppt)			DO (mg/l)			DO Saturation (%)			Turbidity (NTU)				Suspended Solids (mg/l)							
				1	2	Ave.*	1	2	Ave.*	1	2	Ave.*	1	2	Ave.*	1	2	Ave.*	1	2	Ave.*	D.A.**	1	2	Ave.*	D.A.**				
CS1	1410	11.1	Surface	27.9	27.9	27.9	7.1	7.1	7.1	26.1	26.2	26.2	5.4	5.3	5.4	79.8	78.2	79.0	4.3	4.2	4.3					6.8	6.8	6.8		
			Middle	27.8	27.7	27.8	7.2	7.2	7.2	26.3	26.3	26.3	5.1	5.2	5.2	75.4	76.9	76.2	4.7	4.8	4.8	4.6					7.6	7.8	7.7	7.4
			Bottom	27.7	27.7	27.7	7.1	7.2	7.2	26.4	26.5	26.5	5.0	5.1	5.1	73.4	74.9	74.2	4.9	4.9	4.9					7.6	7.8	7.7		
WM1	1336	14.3	Surface	28.0	27.9	28.0	7.0	7.1	7.1	26.1	26.1	26.1	6.0	5.9	6.0	88.6	87.1	87.9	4.3	4.3	4.3					6.6	6.8	6.7		
			Middle	27.8	27.8	27.8	7.3	7.2	7.3	26.2	26.3	26.3	5.7	5.8	5.8	84.3	85.8	85.1	4.6	4.5	4.6	4.6					7.2	7.0	7.1	7.2
			Bottom	27.6	27.7	27.7	7.1	7.2	7.2	26.5	26.5	26.5	5.6	5.7	5.7	82.2	83.7	83.0	4.8	4.9	4.9					7.8	7.8	7.8		
WM2	1306	5.7	Surface	27.9	27.8	27.9	7.3	7.2	7.3	26.1	26.2	26.2	6.0	6.1	6.1	88.6	90.1	89.4	4.1	4.2	4.2					6.6	6.8	6.7		
			Middle																			4.2							6.8	
			Bottom	27.8	27.8	27.8	7.2	7.2	7.2	26.2	26.3	26.3	5.9	6.0	6.0	86.6	88.0	87.3	4.3	4.3	4.3					6.8	6.8	6.8		
WM3	1234	9.3	Surface	27.9	28.0	28.0	7.0	7.1	7.1	26.1	26.2	26.2	6.3	6.2	6.3	93.1	91.6	92.4	3.7	3.8	3.8					5.8	6.0	5.9		
			Middle	27.9	27.8	27.9	7.1	7.1	7.1	26.2	26.3	26.3	6.1	6.2	6.2	90.2	91.7	91.0	4.3	4.4	4.4	4.3					6.8	6.8	6.8	6.7
			Bottom	27.6	27.7	27.7	7.1	7.2	7.2	26.4	26.5	26.5	5.9	6.0	6.0	86.6	88.1	87.4	4.7	4.6	4.7					7.6	7.4	7.5		
WM4	1202	10.9	Surface	28.0	28.0	28.0	7.1	7.1	7.1	26.2	26.1	26.2	6.2	6.1	6.2	91.5	90.1	90.8	3.6	3.7	3.7					6.8	6.6	6.7		
			Middle	27.9	27.9	27.9	7.2	7.3	7.3	26.3	26.3	26.3	6.1	6.0	6.1	70.3	88.7	79.5	4.3	4.4	4.4	4.3					7.4	7.6	7.5	7.5
			Bottom	27.7	27.7	27.7	7.2	7.1	7.2	26.5	26.4	26.5	5.7	5.8	5.8	83.7	85.1	84.4	4.9	4.8	4.9					8.2	8.2	8.2		
CS2	1130	14.7	Surface	27.9	28.0	28.0	7.2	7.1	7.2	26.2	26.2	26.2	5.5	5.0	5.3	81.2	82.7	82.0	4.3	4.2	4.3					6.6	6.6	6.6		
			Middle	27.8	27.9	27.9	7.1	7.1	7.1	26.3	26.2	26.3	5.4	5.5	5.5	79.9	81.3	80.6	4.7	4.8	4.8	4.7					7.4	7.6	7.5	7.5
			Bottom	27.6	27.7	27.7	7.2	7.3	7.3	26.5	26.5	26.5	5.2	5.3	5.3	76.3	77.8	77.1	5.1	5.2	5.2					8.2	8.4	8.3		

Remark or Observation:

Note: * Average

** Depth Average

SIL(E) Water Quality Monitoring Data Record Sheet

Date: 11-Oct-13
 Tide: Mid-Ebb
 Weather: Fine
 Sea Conditions: Small Wave
 Upstream Control Station CS1

Location	Sampling Time	Water Depth (m)	Monitoring Depth	Temperature (°C)			pH			Salinity (ppt)			DO (mg/l)			DO Saturation (%)			Turbidity (NTU)				Suspended Solids (mg/l)							
				1	2	Ave.*	1	2	Ave.*	1	2	Ave.*	1	2	Ave.*	1	2	Ave.*	1	2	Ave.*	D.A.**	1	2	Ave.*	D.A.**				
CS1	1600	10.8	Surface	27.8	27.9	27.9	7.1	7.1	7.1	26.2	26.1	26.2	5.2	5.2	5.2	76.8	76.8	76.8	4.6	4.7	4.7					7.2	7.4	7.3		
			Middle	27.8	27.8	27.8	7.2	7.1	7.2	26.3	26.3	26.3	4.9	5.0	5.0	72.5	74.0	73.3	4.9	5.0	5.0	5.0					7.8	8.0	7.9	7.9
			Bottom	27.6	27.7	27.7	7.3	7.3	7.3	26.4	26.5	26.5	4.8	4.9	4.9	70.5	71.9	71.2	5.2	5.3	5.3					8.4	8.4	8.4		
WM1	1632	14.1	Surface	27.9	28.0	28.0	7.0	7.1	7.1	26.1	26.1	26.1	5.8	5.9	5.9	85.7	87.1	86.4	4.3	4.4	4.4					6.6	6.8	6.7		
			Middle	27.8	27.9	27.9	7.2	7.3	7.3	26.2	26.3	26.3	5.5	5.6	5.6	81.3	82.8	82.1	4.6	4.6	4.6	4.6					7.0	7.2	7.1	7.2
			Bottom	27.7	27.6	27.7	7.2	7.1	7.2	26.5	26.5	26.5	5.4	5.3	5.4	79.2	77.8	78.5	4.9	5.0	5.0					7.8	8.0	7.9		
WM2	1702	5.5	Surface	28.0	27.9	28.0	7.2	7.2	7.2	26.2	26.1	26.2	5.9	6.0	6.0	87.2	88.7	88.0	4.3	4.3	4.3					6.6	6.8	6.7		
			Middle																			4.4							6.9	
			Bottom	27.8	27.9	27.9	7.1	7.2	7.2	26.3	26.2	26.3	5.7	5.8	5.8	84.3	85.8	85.1	4.4	4.5	4.5					7.0	7.2	7.1		
WM3	1734	9.1	Surface	27.9	27.9	27.9	7.1	7.0	7.1	26.2	26.2	26.2	6.1	6.2	6.2	90.1	91.5	90.8	3.9	4.0	4.0					6.0	6.4	6.2		
			Middle	27.8	27.7	27.8	7.2	7.3	7.3	26.3	26.2	26.3	6.0	6.0	6.0	88.7	88.6	88.7	4.5	4.5	4.5	4.4					7.2	7.0	7.1	7.0
			Bottom	27.6	27.6	27.6	7.1	7.2	7.2	26.5	26.4	26.5	5.7	5.8	5.8	83.7	85.1	84.4	4.8	4.9	4.9					7.6	7.8	7.7		
WM4	1806	10.7	Surface	27.9	28.0	28.0	7.1	7.1	7.1	26.1	26.2	26.2	6.0	5.9	6.0	88.6	87.2	87.9	3.8	3.8	3.8					6.0	6.0	6.0		
			Middle	27.8	27.9	27.9	7.2	7.1	7.2	26.3	26.2	26.3	5.9	5.8	5.9	87.3	85.8	86.6	4.5	4.4	4.5	4.4					7.2	6.8	7.0	7.0
			Bottom	27.6	27.7	27.7	7.3	7.2	7.3	26.4	26.4	26.4	5.6	5.6	5.6	82.2	82.2	82.2	5.0	4.9	5.0					7.8	8.0	7.9		
CS2	1838	14.6	Surface	28.0	27.9	28.0	7.1	7.2	7.2	26.2	26.1	26.2	5.4	5.4	5.4	79.8	79.7	79.8	4.4	4.5	4.5					7.0	7.0	7.0		
			Middle	27.8	27.8	27.8	7.3	7.2	7.3	26.3	26.3	26.3	5.2	5.3	5.3	76.9	78.4	77.7	4.6	4.7	4.7	4.7					7.4	7.4	7.4	7.4
			Bottom	27.7	27.6	27.7	7.1	7.1	7.1	26.5	26.4	26.5	5.0	5.1	5.1	73.4	74.9	74.2	4.9	4.9	4.9					7.8	8.0	7.9		

Remark or Observation:

Note: * Average

** Depth Average

SIL(E) Water Quality Monitoring Data Record Sheet

Date: 15-Oct-13
 Tide: Mid-Flood
 Weather: Fine
 Sea Conditions: Small Wave
 Upstream Control Station CS2

Location	Sampling Time	Water Depth (m)	Monitoring Depth	Temperature (°C)			pH			Salinity (ppt)			DO (mg/l)			DO Saturation (%)			Turbidity (NTU)				Suspended Solids (mg/l)			
				1	2	Ave.*	1	2	Ave.*	1	2	Ave.*	1	2	Ave.*	1	2	Ave.*	1	2	Ave.*	D.A.**	1	2	Ave.*	D.A.**
CS1	1605	13.0	Surface	27.6	27.6	27.6	7.2	7.2	7.2	26.5	26.6	26.6	5.8	5.8	5.8	85.6	85.3	85.5	4.4	4.5	4.5	7.0	7.0	7.0		
			Middle	27.5	27.5	27.5	7.2	7.1	7.2	26.6	26.7	26.7	5.7	5.6	5.7	84.0	83.3	83.7	4.4	4.3	4.4	4.5	7.0	6.8	6.9	7.2
			Bottom	27.4	27.4	27.4	7.1	7.2	7.2	26.8	26.8	26.8	5.5	5.5	5.5	81.7	81.3	81.5	4.8	4.8	4.8	7.8	7.8	7.8		
WM1	1528	13.2	Surface	27.6	27.6	27.6	7.1	7.2	7.2	26.5	26.5	26.5	5.8	5.7	5.8	85.1	84.8	85.0	4.4	4.4	4.4	6.8	7.0	6.9		
			Middle	27.5	27.5	27.5	7.2	7.2	7.2	26.6	26.6	26.6	5.6	5.6	5.6	83.3	82.9	83.1	4.5	4.6	4.6	4.6	7.0	7.2	7.1	7.2
			Bottom	27.4	27.3	27.4	7.2	7.1	7.2	26.7	26.8	26.8	5.6	5.5	5.6	82.1	81.7	81.9	4.7	4.8	4.8	7.6	7.6	7.6		
WM2	1500	5.8	Surface	27.6	27.6	27.6	7.1	7.1	7.1	26.4	26.5	26.5	5.7	5.7	5.7	84.7	84.4	84.6	4.1	4.2	4.2	6.4	6.6	6.5		
			Middle																		4.3			6.7		
			Bottom	27.6	27.6	27.6	7.1	7.2	7.2	26.5	26.6	26.6	5.7	5.6	5.7	83.7	83.2	83.5	4.4	4.5	4.5	6.8	7.0	6.9		
WM3	1433	8.8	Surface	27.6	27.6	27.6	7.1	7.2	7.2	26.4	26.5	26.5	5.8	5.7	5.8	85.1	84.6	84.9	4.3	4.4	4.4	6.8	7.0	6.9		
			Middle	27.6	27.6	27.6	7.1	7.1	7.1	26.6	26.6	26.6	5.7	5.7	5.7	84.5	84.1	84.3	4.3	4.3	4.3	4.4	6.8	6.8	6.8	7.0
			Bottom	27.5	27.5	27.5	7.1	7.2	7.2	26.7	26.7	26.7	5.6	5.6	5.6	82.9	82.4	82.7	4.5	4.6	4.6	7.2	7.4	7.3		
WM4	1405	9.0	Surface	27.6	27.6	27.6	7.1	7.1	7.1	26.4	26.4	26.4	5.9	5.8	5.9	86.6	86.2	86.4	4.2	4.3	4.3	6.6	6.8	6.7		
			Middle	27.6	27.5	27.6	7.1	7.1	7.1	26.5	26.5	26.5	5.8	5.7	5.8	85.4	84.7	85.1	4.1	4.2	4.2	4.3	6.6	6.6	6.6	6.9
			Bottom	27.5	27.5	27.5	7.1	7.1	7.1	26.6	26.6	26.6	5.7	5.7	5.7	83.7	83.4	83.6	4.5	4.6	4.6	7.2	7.4	7.3		
CS2	1330	13.0	Surface	27.6	27.6	27.6	7.1	7.2	7.2	26.3	26.4	26.4	5.8	5.8	5.8	86.0	85.6	85.8	4.3	4.4	4.4	6.6	7.0	6.8		
			Middle	27.5	27.5	27.5	7.1	7.1	7.1	26.4	26.5	26.5	5.7	5.6	5.7	84.2	83.3	83.8	4.4	4.5	4.5	4.5	7.0	7.2	7.1	7.1
			Bottom	27.4	27.3	27.4	7.1	7.2	7.2	26.7	26.7	26.7	5.6	5.5	5.6	82.1	81.7	81.9	4.6	4.7	4.7	7.4	7.4	7.4		

Remark or Observation:

Note: * Average

** Depth Average

SIL(E) Water Quality Monitoring Data Record Sheet

Date: 15-Oct-13
 Tide: Mid-Ebb
 Weather: Fine
 Sea Conditions: Small Wave
 Upstream Control Station CS1

Location	Sampling Time	Water Depth (m)	Monitoring Depth	Temperature (°C)			pH			Salinity (ppt)			DO (mg/l)			DO Saturation (%)			Turbidity (NTU)				Suspended Solids (mg/l)					
				1	2	Ave.*	1	2	Ave.*	1	2	Ave.*	1	2	Ave.*	1	2	Ave.*	1	2	Ave.*	D.A.**	1	2	Ave.*	D.A.**		
CS1	0900	12.6	Surface	27.5	27.5	27.5	7.0	7.1	7.1	26.0	26.1	26.1	5.8	5.7	5.8	84.9	84.4	84.7	4.6	4.5	4.6	7.2	7.0	7.1				
			Middle	27.5	27.4	27.5	7.1	7.1	7.1	26.1	26.1	26.1	5.7	5.6	5.7	83.4	83.1	83.3	4.2	4.3	4.3	4.6	6.6	6.8	6.7	7.2		
			Bottom	27.4	27.4	27.4	7.1	7.2	7.2	26.3	26.4	26.4	5.4	5.3	5.4	79.4	78.8	79.1	4.9	5.0	5.0		7.8	7.8	7.8			
WM1	0938	12.8	Surface	27.5	27.4	27.5	7.1	7.1	7.1	26.2	26.1	26.2	5.7	5.6	5.7	83.7	83.3	83.5	4.8	4.7	4.8	7.6	7.4	7.5				
			Middle	27.4	27.4	27.4	7.1	7.2	7.2	26.3	26.3	26.3	5.5	5.4	5.5	81.3	80.4	80.9	4.4	4.5	4.5	4.7	6.8	7.2	7.0	7.4		
			Bottom	27.4	27.4	27.4	7.2	7.2	7.2	26.4	26.5	26.5	5.4	5.4	5.4	80.1	79.3	79.7	4.8	4.9	4.9		7.6	7.8	7.7			
WM2	1010	5.6	Surface	27.5	27.5	27.5	7.1	7.1	7.1	26.2	26.2	26.2	5.6	5.6	5.6	83.1	82.6	82.9	4.3	4.4	4.4	6.6	6.8	6.7				
			Middle																			4.5					7.1	
			Bottom	27.5	27.5	27.5	7.1	7.1	7.1	26.2	26.3	26.3	5.5	5.4	5.5	81.8	80.3	81.1	4.6	4.7	4.7		7.4	7.6	7.5			
WM3	1038	8.6	Surface	27.6	27.5	27.6	7.2	7.2	7.2	26.3	26.4	26.4	5.7	5.8	5.8	84.7	85.2	85.0	4.4	4.5	4.5	6.8	7.0	6.9				
			Middle	27.5	27.5	27.5	7.1	7.2	7.2	26.4	26.4	26.4	5.6	5.6	5.6	83.3	82.9	83.1	4.2	4.3	4.3	4.5	6.6	6.8	6.7	7.0		
			Bottom	27.5	27.4	27.5	7.2	7.2	7.2	26.6	26.6	26.6	5.7	5.6	5.7	83.5	82.8	83.2	4.7	4.7	4.7		7.4	7.4	7.4			
WM4	1107	8.8	Surface	27.6	27.6	27.6	7.1	7.1	7.1	26.3	26.2	26.3	5.8	5.9	5.9	86.1	86.5	86.3	4.3	4.3	4.3	6.6	6.8	6.7				
			Middle	27.5	27.5	27.5	7.1	7.1	7.1	26.4	26.5	26.5	5.7	5.6	5.7	83.7	83.3	83.5	4.2	4.2	4.2	4.3	6.8	6.6	6.7	6.8		
			Bottom	27.4	27.4	27.4	7.0	7.1	7.1	26.6	26.6	26.6	5.7	5.7	5.7	84.1	83.9	84.0	4.4	4.5	4.5		7.0	7.0	7.0			
CS2	1140	13.0	Surface	27.6	27.6	27.6	7.1	7.0	7.1	26.3	26.3	26.3	5.8	5.7	5.8	85.3	84.8	85.1	4.5	4.5	4.5	7.0	7.0	7.0				
			Middle	27.5	27.4	27.5	7.1	7.1	7.1	26.5	26.5	26.5	5.6	5.5	5.6	82.3	81.8	82.1	4.3	4.2	4.3	4.5	6.8	6.6	6.7	7.0		
			Bottom	27.4	27.3	27.4	7.1	7.1	7.1	26.7	26.7	26.7	5.4	5.4	5.4	80.4	79.9	80.2	4.6	4.7	4.7		7.4	7.4	7.4			

Remark or Observation:

Note: * Average

** Depth Average

SIL(E) Water Quality Monitoring Data Record Sheet

Date: 17-Oct-13
 Tide: Mid-Flood
 Weather: Fine
 Sea Conditions: Small Wave
 Upstream Control Station CS2

Location	Sampling Time	Water Depth (m)	Monitoring Depth	Temperature (°C)			pH			Salinity (ppt)			DO (mg/l)			DO Saturation (%)			Turbidity (NTU)				Suspended Solids (mg/l)			
				1	2	Ave.*	1	2	Ave.*	1	2	Ave.*	1	2	Ave.*	1	2	Ave.*	1	2	Ave.*	D.A.**	1	2	Ave.*	D.A.**
CS1	1713	12.7	Surface	27.5	27.5	27.5	7.1	7.1	7.1	26.1	26.1	26.1	5.8	5.8	5.8	85.1	85.1	85.1	4.4	4.3	4.4	6.8	6.6	6.7		
			Middle	27.4	27.5	27.5	7.0	7.1	7.1	26.2	26.1	26.2	5.7	5.6	5.7	84.0	82.5	83.3	4.4	4.5	4.5	4.5	7.0	7.0	7.0	7.0
			Bottom	27.4	27.3	27.4	7.2	7.1	7.2	26.3	26.2	26.3	5.5	5.4	5.5	81.3	79.8	80.6	4.6	4.6	4.6	7.2	7.4	7.3		
WM1	1640	13.0	Surface	27.5	27.4	27.5	7.2	7.1	7.2	26.0	26.1	26.1	6.0	6.1	6.1	87.9	89.4	88.7	4.3	4.2	4.3	6.8	6.6	6.7		
			Middle	27.4	27.4	27.4	7.1	7.1	7.1	26.2	26.2	26.2	5.7	5.8	5.8	83.8	85.3	84.6	4.0	4.1	4.1	4.3	6.4	6.6	6.5	6.8
			Bottom	27.4	27.3	27.4	7.1	7.0	7.1	26.3	26.2	26.3	5.4	5.4	5.4	79.9	79.9	79.9	4.5	4.6	4.6	7.2	7.4	7.3		
WM2	1608	5.8	Surface	27.4	27.5	27.5	7.1	7.1	7.1	26.1	26.0	26.1	6.1	6.0	6.1	89.5	88.0	88.8	4.3	4.3	4.3	6.8	6.8	6.8		
			Middle																		4.4			7.0		
			Bottom	27.4	27.4	27.4	7.2	7.1	7.2	26.2	26.2	26.2	5.7	5.7	5.7	83.8	83.8	83.8	4.4	4.4	4.4	7.2	7.0	7.1		
WM3	1535	8.9	Surface	27.6	27.6	27.6	7.0	7.1	7.1	26.1	26.0	26.1	6.1	6.0	6.1	89.4	87.9	88.7	4.3	4.2	4.3	6.8	6.6	6.7		
			Middle	27.6	27.5	27.6	7.2	7.1	7.2	26.1	26.2	26.2	5.9	5.8	5.9	86.8	85.4	86.1	4.1	4.0	4.1	4.3	6.4	6.4	6.4	6.7
			Bottom	27.4	27.4	27.4	7.1	7.0	7.1	26.3	26.3	26.3	5.6	5.6	5.6	82.8	82.8	82.8	4.5	4.5	4.5	7.2	7.0	7.1		
WM4	1503	9.1	Surface	27.6	27.6	27.6	7.1	7.1	7.1	26.0	26.0	26.0	6.1	6.2	6.2	89.4	90.9	90.2	4.2	4.2	4.2	6.6	6.6	6.6		
			Middle	27.5	27.5	27.5	7.0	7.1	7.1	26.2	26.1	26.2	6.0	5.9	6.0	88.3	86.8	87.6	4.1	4.1	4.1	4.2	6.4	6.4	6.4	6.6
			Bottom	27.3	27.4	27.4	7.2	7.1	7.2	26.2	26.3	26.3	5.7	5.8	5.8	84.2	85.7	85.0	4.4	4.3	4.4	6.8	6.8	6.8		
CS2	1430	13.3	Surface	27.7	27.7	27.7	7.2	7.1	7.2	26.1	26.0	26.1	5.9	6.0	6.0	86.5	87.8	87.2	4.4	4.5	4.5	6.8	7.0	6.9		
			Middle	27.6	27.5	27.6	7.1	7.1	7.1	26.2	26.2	26.2	5.7	5.8	5.8	83.9	85.4	84.7	4.6	4.6	4.6	4.6	7.2	7.2	7.2	7.3
			Bottom	27.4	27.3	27.4	7.2	7.2	7.2	26.3	26.2	26.3	5.5	5.6	5.6	81.3	82.7	82.0	4.7	4.8	4.8	7.6	7.8	7.7		

Remark or Observation:

Note: * Average

** Depth Average

SIL(E) Water Quality Monitoring Data Record Sheet

Date: 17-Oct-13
 Tide: Mid-Ebb
 Weather: Fine
 Sea Conditions: Small Wave
 Upstream Control Station CS1

Location	Sampling Time	Water Depth (m)	Monitoring Depth	Temperature (°C)			pH			Salinity (ppt)			DO (mg/l)			DO Saturation (%)			Turbidity (NTU)				Suspended Solids (mg/l)				
				1	2	Ave.*	1	2	Ave.*	1	2	Ave.*	1	2	Ave.*	1	2	Ave.*	1	2	Ave.*	D.A.**	1	2	Ave.*	D.A.**	
CS1	1000	12.5	Surface	27.6	27.5	27.6	7.0	7.1	7.1	26.1	26.0	26.1	5.7	5.6	5.7	83.6	82.1	82.9	4.7	4.8	4.8	7.4	7.6	7.5			
			Middle	27.5	27.4	27.5	7.1	7.1	7.1	26.1	26.1	26.1	5.6	5.6	5.6	82.0	82.0	82.0	4.6	4.5	4.6	4.8	7.2	7.0	7.1	7.5	
			Bottom	27.4	27.4	27.4	7.2	7.2	7.2	26.3	26.2	26.3	5.4	5.3	5.4	79.8	78.3	79.1	5.0	5.1	5.1		8.0	8.0	8.0		
WM1	1051	12.9	Surface	27.5	27.5	27.5	7.2	7.2	7.2	26.1	26.1	26.1	5.9	5.9	5.9	85.0	86.5	85.8	4.6	4.5	4.6	7.2	7.0	7.1			
			Middle	27.4	27.5	27.5	7.2	7.1	7.2	26.1	26.2	26.2	5.5	5.6	5.6	80.8	82.3	81.6	4.3	4.4	4.4	4.6	6.8	7.0	6.9	7.2	
			Bottom	27.4	27.3	27.4	7.1	7.1	7.1	26.3	26.3	26.3	5.3	5.2	5.3	78.3	76.9	77.6	4.8	4.8	4.8		7.6	7.4	7.5		
WM2	1103	5.6	Surface	27.5	27.6	27.6	7.1	7.1	7.1	26.0	26.1	26.1	5.7	5.8	5.8	83.6	85.0	84.3	4.4	4.5	4.5	6.8	7.0	6.9			
			Middle																								7.1
			Bottom	27.5	27.5	27.5	7.1	7.2	7.2	26.2	26.3	26.3	5.5	5.6	5.6	81.2	82.8	82.0	4.6	4.6	4.6		7.2	7.2	7.2		
WM3	1136	8.7	Surface	27.5	27.6	27.6	7.1	7.0	7.1	26.1	26.0	26.1	5.8	5.9	5.9	85.1	86.4	85.8	4.5	4.4	4.5	7.0	7.0	7.0			
			Middle	27.5	27.5	27.5	7.1	7.1	7.1	26.2	26.2	26.2	5.7	5.6	5.7	83.8	82.3	83.1	4.2	4.3	4.3	4.5	6.6	6.8	6.7	7.0	
			Bottom	27.3	27.4	27.4	7.2	7.1	7.2	26.3	26.2	26.3	5.5	5.4	5.5	81.3	80.0	80.7	4.6	4.7	4.7		7.2	7.4	7.3		
WM4	1208	8.9	Surface	27.6	27.6	27.6	7.0	7.1	7.1	26.1	26.1	26.1	5.9	6.0	6.0	86.5	88.0	87.3	4.3	4.4	4.4	6.8	7.0	6.9			
			Middle	27.5	27.4	27.5	7.2	7.1	7.2	26.2	26.2	26.2	5.8	5.7	5.8	85.3	83.8	84.6	4.3	4.2	4.3	4.4	6.6	6.6	6.6	6.9	
			Bottom	27.3	27.3	27.3	7.1	7.1	7.1	26.3	26.3	26.3	5.6	5.5	5.6	82.8	81.4	82.1	4.5	4.6	4.6		7.4	7.2	7.3		
CS2	1240	13.1	Surface	27.6	27.5	27.6	7.1	7.2	7.2	26.1	26.0	26.1	5.7	5.8	5.8	83.5	85.0	84.3	4.2	4.3	4.3	6.6	6.8	6.7			
			Middle	27.4	27.5	27.5	7.1	7.0	7.1	26.1	26.2	26.2	5.6	5.6	5.6	82.3	82.4	82.4	4.6	4.5	4.6	4.5	7.2	7.0	7.1	7.1	
			Bottom	27.3	27.4	27.4	7.2	7.2	7.2	26.2	26.3	26.3	5.4	5.5	5.5	79.9	81.3	80.6	4.8	4.7	4.8		7.6	7.4	7.5		

Remark or Observation:

Note: * Average

** Depth Average

SIL(E) Water Quality Monitoring Data Record Sheet

Date: 19-Oct-13
 Tide: Mid-Flood
 Weather: Cloudy
 Sea Conditions: Small Wave
 Upstream Control Station CS2

Location	Sampling Time	Water Depth (m)	Monitoring Depth	Temperature (°C)			pH			Salinity (ppt)			DO (mg/l)			DO Saturation (%)			Turbidity (NTU)				Suspended Solids (mg/l)							
				1	2	Ave.*	1	2	Ave.*	1	2	Ave.*	1	2	Ave.*	1	2	Ave.*	1	2	Ave.*	D.A.**	1	2	Ave.*	D.A.**				
CS1	1810	11.0	Surface	26.9	26.9	26.9	7.1	7.1	7.1	29.0	29.0	29.0	5.0	5.0	5.0	74.6	74.2	74.4	4.7	4.7	4.7					7.4	7.4	7.4		
			Middle	26.8	26.8	26.8	7.1	7.1	7.1	29.0	29.0	29.0	4.9	4.9	4.9	73.1	72.8	73.0	5.0	5.0	5.0	5.0					7.8	7.8	7.8	7.8
			Bottom	26.7	26.7	26.7	7.1	7.1	7.1	29.1	29.1	29.1	4.7	4.7	4.7	70.2	70.6	70.4	5.2	5.2	5.2					8.2	8.0	8.1		
WM1	1737	14.4	Surface	26.9	26.9	26.9	7.1	7.1	7.1	28.9	28.9	28.9	4.9	4.9	4.9	73.1	72.6	72.9	4.0	4.0	4.0					6.2	6.4	6.3		
			Middle	26.8	26.8	26.8	7.1	7.1	7.1	29.0	29.0	29.0	4.7	4.7	4.7	70.4	70.9	70.7	4.2	4.2	4.2	4.1					6.6	6.8	6.7	6.5
			Bottom	26.8	26.8	26.8	7.1	7.1	7.1	29.0	29.0	29.0	4.7	4.7	4.7	70.3	70.1	70.2	4.1	4.1	4.1					6.6	6.6	6.6		
WM2	1707	5.8	Surface	26.9	26.9	26.9	7.1	7.1	7.1	28.8	28.8	28.8	4.8	4.8	4.8	71.6	71.2	71.4	3.9	3.9	3.9					6.2	6.2	6.2		
			Middle																			4.0							6.3	
			Bottom	26.9	26.8	26.9	7.1	7.1	7.1	28.9	28.9	28.9	4.8	4.8	4.8	71.1	71.4	71.3	4.0	4.0	4.0					6.4	6.4	6.4		
WM3	1632	9.6	Surface	26.9	26.9	26.9	7.1	7.1	7.1	28.9	28.9	28.9	4.7	4.7	4.7	70.5	70.8	70.7	4.5	4.5	4.5					7.0	7.0	7.0		
			Middle	26.8	26.8	26.8	7.1	7.1	7.1	29.0	29.0	29.0	4.6	4.6	4.6	69.6	69.2	69.4	4.2	4.2	4.2	4.2					6.6	6.8	6.7	6.6
			Bottom	26.8	26.8	26.8	7.1	7.1	7.1	29.0	29.0	29.0	4.6	4.6	4.6	69.1	69.4	69.3	3.9	3.9	3.9					6.2	6.2	6.2		
WM4	1600	10.4	Surface	26.8	26.8	26.8	7.1	7.1	7.1	29.0	29.0	29.0	4.9	4.9	4.9	73.1	72.8	73.0	4.2	4.2	4.2					6.6	6.6	6.6		
			Middle	26.8	26.8	26.8	7.1	7.1	7.1	29.0	29.0	29.0	4.7	4.7	4.7	70.1	70.5	70.3	3.7	3.7	3.7	3.9					6.0	6.0	6.0	6.3
			Bottom	26.8	26.8	26.8	7.1	7.1	7.1	29.0	29.0	29.0	4.6	4.6	4.6	69.2	68.9	69.1	3.8	3.8	3.8					6.4	6.2	6.3		
CS2	1530	14.8	Surface	26.8	26.8	26.8	7.0	7.0	7.0	29.0	29.0	29.0	5.4	5.4	5.4	80.6	80.2	80.4	4.8	4.8	4.8					7.6	7.4	7.5		
			Middle	26.7	26.7	26.7	7.0	7.0	7.0	29.1	29.1	29.1	5.2	5.2	5.2	77.6	77.2	77.4	4.7	4.7	4.7	4.7					7.4	7.4	7.4	7.5
			Bottom	26.7	26.7	26.7	7.1	7.1	7.1	29.2	29.2	29.2	5.2	5.2	5.2	77.1	77.4	77.3	4.7	4.7	4.7					7.6	7.8	7.7		

Remark or Observation:

Note: * Average

** Depth Average

SIL(E) Water Quality Monitoring Data Record Sheet

Date: 19-Oct-13
 Tide: Mid-Ebb
 Weather: Cloudy
 Sea Conditions: Small Wave
 Upstream Control Station CS1

Location	Sampling Time	Water Depth (m)	Monitoring Depth	Temperature (°C)			pH			Salinity (ppt)			DO (mg/l)			DO Saturation (%)			Turbidity (NTU)				Suspended Solids (mg/l)			
				1	2	Ave.*	1	2	Ave.*	1	2	Ave.*	1	2	Ave.*	1	2	Ave.*	1	2	Ave.*	D.A.**	1	2	Ave.*	D.A.**
CS1	1100	10.2	Surface	26.8	26.8	26.8	7.0	7.0	7.0	28.9	28.9	28.9	5.0	5.0	5.0	74.5	74.1	74.3	4.8	4.8	4.8	7.4	7.6	7.5		
			Middle	26.8	26.8	26.8	7.0	7.0	7.0	28.9	28.9	28.9	4.8	4.8	4.8	71.5	71.8	71.7	5.4	5.4	5.4	5.3	8.4	8.6	8.5	8.4
			Bottom	26.7	26.7	26.7	7.0	7.0	7.0	28.9	28.9	28.9	4.8	4.8	4.8	71.2	71.6	71.4	5.7	5.7	5.7		9.0	9.2	9.1	
WM1	1130	13.8	Surface	26.8	26.9	26.9	7.0	7.0	7.0	28.9	28.9	28.9	4.8	4.8	4.8	71.6	71.2	71.4	4.0	4.0	4.0		6.2	6.4	6.3	
			Middle	26.7	26.7	26.7	7.0	7.0	7.0	28.9	28.9	28.9	4.6	4.6	4.6	68.6	69.0	68.8	3.9	3.9	3.9	3.9	6.2	6.2	6.2	6.3
			Bottom	26.7	26.7	26.7	7.0	7.0	7.0	29.0	29.0	29.0	4.6	4.6	4.6	68.2	68.4	68.3	3.9	3.9	3.9		6.2	6.4	6.3	
WM2	1205	5.2	Surface	26.9	26.9	26.9	7.0	7.0	7.0	28.9	28.9	28.9	4.7	4.7	4.7	70.1	70.6	70.4	3.7	3.7	3.7		6.0	6.0	6.0	
			Middle																		3.6				5.8	
			Bottom	26.8	26.8	26.8	7.1	7.1	7.1	29.0	29.0	29.0	4.7	4.7	4.7	70.5	70.9	70.7	3.4	3.4	3.4		5.4	5.6	5.5	
WM3	1235	8.8	Surface	26.9	26.9	26.9	7.1	7.1	7.1	28.9	28.9	28.9	4.7	4.7	4.7	70.0	70.4	70.2	3.5	3.5	3.5		5.6	5.8	5.7	
			Middle	26.9	26.9	26.9	7.1	7.1	7.1	28.9	28.9	28.9	4.8	4.8	4.8	72.1	72.5	72.3	3.8	3.8	3.8	3.7	6.2	6.2	6.2	6.0
			Bottom	26.8	26.8	26.8	7.1	7.1	7.1	28.9	28.9	28.9	4.8	4.8	4.8	71.7	71.9	71.8	3.8	3.8	3.8		6.2	6.0	6.1	
WM4	1307	9.8	Surface	26.9	26.9	26.9	7.1	7.1	7.1	28.9	28.9	28.9	4.8	4.8	4.8	71.6	72.0	71.8	3.9	3.9	3.9		6.0	6.2	6.1	
			Middle	26.8	26.8	26.8	7.1	7.1	7.1	29.0	29.0	29.0	4.7	4.7	4.7	70.7	70.9	70.8	4.1	4.1	4.1	4.0	6.6	6.4	6.5	6.4
			Bottom	26.8	26.8	26.8	7.1	7.1	7.1	29.0	29.0	29.0	4.7	4.7	4.7	70.3	70.7	70.5	4.0	4.0	4.0		6.4	6.6	6.5	
CS2	1340	14.2	Surface	26.9	26.9	26.9	7.1	7.1	7.1	29.0	29.0	29.0	5.2	5.2	5.2	77.6	77.2	77.4	4.0	4.0	4.0		6.4	6.2	6.3	
			Middle	26.8	26.8	26.8	7.1	7.1	7.1	29.0	29.0	29.0	5.1	5.1	5.1	76.1	76.5	76.3	4.4	4.4	4.4	4.2	7.0	7.0	7.0	6.8
			Bottom	26.7	26.7	26.7	7.1	7.1	7.1	29.1	29.1	29.1	5.1	5.1	5.1	75.9	76.3	76.1	4.3	4.3	4.3		7.0	7.2	7.1	

Remark or Observation:

Note: * Average

** Depth Average

SIL(E) Water Quality Monitoring Data Record Sheet

Date: 21-Oct-13
 Tide: Mid-Flood
 Weather: Fine
 Sea Conditions: Small Wave
 Upstream Control Station CS2

Location	Sampling Time	Water Depth (m)	Monitoring Depth	Temperature (°C)			pH			Salinity (ppt)			DO (mg/l)			DO Saturation (%)			Turbidity (NTU)				Suspended Solids (mg/l)								
				1	2	Ave.*	1	2	Ave.*	1	2	Ave.*	1	2	Ave.*	1	2	Ave.*	1	2	Ave.*	D.A.**	1	2	Ave.*	D.A.**					
CS1	0939	11.2	Surface	26.8	26.8	26.8	7.1	7.1	7.1	28.0	28.0	28.0	5.1	5.0	5.1	74.4	74.0	74.2	4.8	4.9	4.9	7.6	7.6	7.6							
			Middle	26.7	26.7	26.7	7.1	7.0	7.1	28.1	28.1	28.1	4.9	4.9	4.9	72.4	71.6	72.0	4.8	4.7	4.8	4.9	7.6	7.4	7.5	7.7					
			Bottom	26.6	26.6	26.6	7.1	7.1	7.1	28.3	28.3	28.3	4.6	4.7	4.7	68.3	68.9	68.6	5.1	5.1	5.1		8.2	8.0	8.1						
WM1	0905	14.6	Surface	26.8	26.7	26.8	7.0	7.1	7.1	28.0	27.9	28.0	4.9	4.8	4.9	71.5	71.1	71.3	4.7	4.7	4.7	7.4	7.4	7.4							
			Middle	26.6	26.6	26.6	7.1	7.1	7.1	28.1	28.2	28.2	4.7	4.6	4.7	68.9	68.3	68.6	4.5	4.6	4.6	4.7	7.2	7.4	7.3	7.5					
			Bottom	26.5	26.5	26.5	7.2	7.2	7.2	28.3	28.4	28.4	4.5	4.5	4.5	66.7	66.2	66.5	4.9	4.9	4.9		7.8	7.6	7.7						
WM2	0838	5.8	Surface	26.8	26.8	26.8	7.1	7.1	7.1	27.9	27.9	27.9	5.0	4.9	5.0	73.1	72.5	72.8	4.5	4.5	4.5	7.0	7.2	7.1							
			Middle																		4.6								7.3		
			Bottom	26.7	26.8	26.8	7.1	7.2	7.2	27.9	28.0	28.0	4.8	4.8	4.8	70.3	70.6	70.5	4.6	4.7	4.7		7.4	7.4	7.4						
WM3	0810	9.8	Surface	26.8	26.7	26.8	7.1	7.0	7.1	27.9	27.9	27.9	5.1	5.0	5.1	74.4	74.1	74.3	4.5	4.5	4.5	7.0	7.0	7.0							
			Middle	26.8	26.7	26.8	7.1	7.0	7.1	28.0	28.0	28.0	5.0	4.9	5.0	73.2	72.8	73.0	4.6	4.5	4.6	4.6	7.2	7.2	7.2	7.2					
			Bottom	26.6	26.7	26.7	7.1	7.1	7.1	28.3	28.2	28.3	4.7	4.8	4.8	69.7	70.2	70.0	4.7	4.7	4.7		7.6	7.4	7.5						
WM4	0744	10.6	Surface	26.7	26.7	26.7	7.0	7.0	7.0	28.0	28.0	28.0	5.1	5.1	5.1	75.7	75.4	75.6	4.2	4.3	4.3	6.6	6.8	6.7							
			Middle	26.7	26.7	26.7	7.0	7.0	7.0	28.1	28.1	28.1	5.1	5.0	5.1	75.0	74.3	74.7	4.4	4.4	4.4	4.4	7.0	7.0	7.0	7.0					
			Bottom	26.6	26.6	26.6	7.0	7.1	7.1	28.4	28.4	28.4	4.8	4.8	4.8	71.3	71.1	71.2	4.5	4.5	4.5		7.2	7.2	7.2						
CS2	0718	14.6	Surface	26.7	26.8	26.8	7.0	7.1	7.1	28.0	27.9	28.0	5.2	5.2	5.2	76.9	76.2	76.6	4.4	4.6	4.5	6.8	7.2	7.0							
			Middle	26.7	26.7	26.7	7.1	7.0	7.1	28.2	28.3	28.3	4.9	4.8	4.9	71.5	70.1	70.8	4.8	4.7	4.8	4.6	7.6	7.4	7.5	7.3					
			Bottom	26.7	26.6	26.7	7.1	7.1	7.1	28.5	28.6	28.6	4.6	4.6	4.6	67.4	68.3	67.9	4.5	4.6	4.6		7.2	7.4	7.3						

Remark or Observation:

Note: * Average

** Depth Average

SIL(E) Water Quality Monitoring Data Record Sheet

Date: 21-Oct-13
 Tide: Mid-Ebb
 Weather: Cloudy
 Sea Conditions: Small Wave
 Upstream Control Station CS1

Location	Sampling Time	Water Depth (m)	Monitoring Depth	Temperature (°C)			pH			Salinity (ppt)			DO (mg/l)			DO Saturation (%)			Turbidity (NTU)				Suspended Solids (mg/l)							
				1	2	Ave.*	1	2	Ave.*	1	2	Ave.*	1	2	Ave.*	1	2	Ave.*	1	2	Ave.*	D.A.**	1	2	Ave.*	D.A.**				
CS1	1230	11.0	Surface	26.9	26.8	26.9	7.0	7.1	7.1	27.9	27.9	27.9	4.9	5.0	5.0	72.5	73.0	72.8	5.0	4.9	5.0					7.8	7.8	7.8		
			Middle	26.8	26.8	26.8	7.1	7.2	7.2	28.0	28.1	28.1	4.8	4.8	4.8	70.6	70.3	70.5	4.8	4.8	4.8	5.0					7.8	7.6	7.7	7.9
			Bottom	26.7	26.6	26.7	7.1	7.2	7.2	28.3	28.3	28.3	4.6	4.5	4.6	68.0	67.1	67.6	5.1	5.2	5.2					8.2	8.2	8.2		
WM1	1307	14.2	Surface	26.8	26.8	26.8	7.1	7.1	7.1	27.9	27.8	27.9	4.8	4.7	4.8	70.3	69.9	70.1	4.9	4.8	4.9					7.8	7.6	7.7		
			Middle	26.7	26.7	26.7	7.2	7.1	7.2	28.0	28.0	28.0	4.6	4.6	4.6	68.3	68.0	68.2	4.7	4.6	4.7	4.9					7.4	7.4	7.4	7.7
			Bottom	26.6	26.6	26.6	7.2	7.2	7.2	28.2	28.3	28.3	4.4	4.4	4.4	65.2	64.8	65.0	5.1	5.1	5.1					8.0	8.2	8.1		
WM2	1332	5.6	Surface	26.9	26.8	26.9	7.0	7.1	7.1	27.8	27.8	27.8	4.9	4.8	4.9	71.6	71.2	71.4	4.7	4.7	4.7					7.4	7.4	7.4		
			Middle																			4.8							7.5	
			Bottom	26.8	26.8	26.8	7.1	7.0	7.1	27.9	27.9	27.9	4.7	4.7	4.7	69.6	69.3	69.5	4.8	4.8	4.8					7.6	7.6	7.6		
WM3	1358	9.4	Surface	26.9	26.9	26.9	7.0	7.1	7.1	27.8	27.9	27.9	4.9	5.0	5.0	72.7	73.1	72.9	4.7	4.6	4.7					7.4	7.2	7.3		
			Middle	26.8	26.8	26.8	7.1	7.0	7.1	28.0	28.0	28.0	4.8	4.8	4.8	70.6	70.3	70.5	4.9	4.8	4.9	4.8					7.8	7.6	7.7	7.6
			Bottom	26.7	26.7	26.7	7.0	7.0	7.0	28.2	28.2	28.2	4.7	4.6	4.7	68.9	68.3	68.6	4.9	5.0	5.0					7.8	7.8	7.8		
WM4	1427	10.4	Surface	26.9	26.8	26.9	7.0	7.0	7.0	27.9	27.9	27.9	4.9	4.8	4.9	71.6	71.1	71.4	4.5	4.5	4.5					7.0	7.0	7.0		
			Middle	26.8	26.8	26.8	7.0	7.0	7.0	28.0	28.1	28.1	4.7	4.7	4.7	69.4	68.9	69.2	4.7	4.8	4.8	4.8					7.4	7.6	7.5	7.4
			Bottom	26.7	26.7	26.7	7.1	7.1	7.1	28.2	28.3	28.3	4.5	4.5	4.5	66.1	66.7	66.4	5.0	5.0	5.0					7.8	7.8	7.8		
CS2	1459	14.2	Surface	26.9	26.9	26.9	7.0	7.1	7.1	27.9	27.9	27.9	5.1	5.0	5.1	74.6	74.3	74.5	4.6	4.7	4.7					7.2	7.4	7.3		
			Middle	26.8	26.7	26.8	7.1	7.1	7.1	28.1	28.2	28.2	4.9	4.8	4.9	71.8	71.2	71.5	4.9	4.8	4.9	4.8					7.8	7.6	7.7	7.6
			Bottom	26.6	26.6	26.6	7.1	7.1	7.1	28.3	28.4	28.4	4.5	4.4	4.5	65.8	65.5	65.7	4.9	4.9	4.9					7.8	7.8	7.8		

Remark or Observation:

Note: * Average

** Depth Average

SIL(E) Water Quality Monitoring Data Record Sheet

Date: 23-Oct-13
 Tide: Mid-Flood
 Weather: Fine
 Sea Conditions: Small Wave
 Upstream Control Station CS2

Location	Sampling Time	Water Depth (m)	Monitoring Depth	Temperature (°C)			pH			Salinity (ppt)			DO (mg/l)			DO Saturation (%)			Turbidity (NTU)				Suspended Solids (mg/l)			
				1	2	Ave.*	1	2	Ave.*	1	2	Ave.*	1	2	Ave.*	1	2	Ave.*	1	2	Ave.*	D.A.**	1	2	Ave.*	D.A.**
CS1	1135-1200	11.1	Surface	26.7	26.7	26.7	7.0	7.1	7.1	27.9	27.9	27.9	5.4	5.5	5.5	78.8	80.2	79.5	4.7	4.8	4.8	7.4	7.6	7.5		
			Middle	26.7	26.7	26.7	7.1	7.1	7.1	28.0	28.1	28.1	4.9	5.0	5.0	71.6	73.1	72.4	4.8	4.9	4.9	4.8	7.6	7.8	7.7	7.7
			Bottom	26.6	26.7	26.7	7.1	7.0	7.1	28.4	28.3	28.4	4.7	4.8	4.8	69.8	71.3	70.6	4.9	4.9	4.9		7.8	7.8	7.8	
WM1	1105-1125	14.7	Surface	26.8	26.7	26.8	7.1	7.1	7.1	28.0	27.9	28.0	5.9	6.0	6.0	86.1	87.5	86.8	4.7	4.8	4.8	7.4	7.6	7.5		
			Middle	26.8	26.7	26.8	7.1	7.0	7.1	28.1	28.1	28.1	5.7	5.8	5.8	83.3	84.8	84.1	4.7	4.6	4.7	4.7	7.4	7.2	7.3	7.4
			Bottom	26.7	26.6	26.7	7.2	7.1	7.2	28.3	28.4	28.4	5.5	5.4	5.5	81.7	80.2	81.0	4.7	4.8	4.8		7.4	7.6	7.5	
WM2	1032-1052	5.9	Surface	26.8	26.8	26.8	7.0	7.1	7.1	28.0	28.0	28.0	6.1	6.1	6.1	90.0	90.1	90.1	4.5	4.6	4.6	7.0	7.2	7.1		
			Middle																			4.6			7.3	
			Bottom	26.6	26.6	26.6	7.1	7.0	7.1	28.0	28.1	28.1	5.9	6.0	6.0	87.6	89.1	88.4	4.6	4.6	4.6		7.4	7.4	7.4	
WM3	1002-1022	9.9	Surface	26.7	26.8	26.8	7.1	7.1	7.1	27.9	28.0	28.0	6.0	6.1	6.1	87.5	89.0	88.3	4.5	4.6	4.6	7.0	7.2	7.1		
			Middle	26.7	26.7	26.7	7.0	7.1	7.1	28.1	28.1	28.1	5.7	5.8	5.8	83.2	84.7	84.0	4.7	4.7	4.7	4.7	7.4	7.4	7.4	7.3
			Bottom	26.6	26.7	26.7	7.2	7.1	7.2	28.3	28.4	28.4	5.5	5.6	5.6	81.5	83.0	82.3	4.8	4.7	4.8		7.6	7.4	7.5	
WM4	0931-0952	10.5	Surface	26.8	26.8	26.8	7.1	7.0	7.1	27.9	28.0	28.0	6.1	6.1	6.1	88.9	89.0	89.0	4.3	4.4	4.4	6.8	7.0	6.9		
			Middle	26.8	26.7	26.8	7.2	7.1	7.2	28.1	28.0	28.1	5.6	5.7	5.7	81.8	83.5	82.7	4.5	4.4	4.5	4.5	7.2	7.0	7.1	7.1
			Bottom	26.6	26.6	26.6	7.1	7.1	7.1	28.4	28.4	28.4	5.4	5.5	5.5	80.0	81.5	80.8	4.6	4.6	4.6		7.4	7.4	7.4	
CS2	0900-0921	14.7	Surface	26.8	26.7	26.8	7.1	7.2	7.2	27.9	27.9	27.9	5.7	5.8	5.8	83.1	84.6	83.9	4.7	4.8	4.8	7.4	7.6	7.5		
			Middle	26.7	26.7	26.7	7.1	7.2	7.2	28.0	28.1	28.1	5.4	5.4	5.4	78.8	78.9	78.9	4.9	4.9	4.9	4.9	7.8	7.6	7.7	7.8
			Bottom	26.6	26.7	26.7	7.2	7.2	7.2	28.4	28.3	28.4	5.0	4.9	5.0	74.1	72.6	73.4	5.0	5.1	5.1		8.0	8.2	8.1	

Remark or Observation:

Note: * Average

** Depth Average

SIL(E) Water Quality Monitoring Data Record Sheet

Date: 23-Oct-13
 Tide: Mid-Ebb
 Weather: Fine
 Sea Conditions: Small Wave
 Upstream Control Station CS1

Location	Sampling Time	Water Depth (m)	Monitoring Depth	Temperature (°C)			pH			Salinity (ppt)			DO (mg/l)			DO Saturation (%)			Turbidity (NTU)				Suspended Solids (mg/l)							
				1	2	Ave.*	1	2	Ave.*	1	2	Ave.*	1	2	Ave.*	1	2	Ave.*	1	2	Ave.*	D.A.**	1	2	Ave.*	D.A.**				
CS1	1330-1352	10.9	Surface	26.8	26.7	26.8	7.0	7.0	7.0	28.0	27.9	28.0	5.3	5.2	5.3	77.3	75.8	76.6	4.9	5.0	5.0	7.6	7.8	7.7						
			Middle	26.7	26.7	26.7	7.1	7.1	7.1	28.1	28.0	28.1	4.7	4.8	4.8	68.7	70.1	69.4	5.3	5.4	5.4	5.3	8.4	8.6	8.5	8.3				
			Bottom	26.7	26.6	26.7	7.1	7.0	7.1	28.3	28.3	28.3	4.5	4.6	4.6	66.8	68.3	67.6	5.4	5.5	5.5		8.6	8.8	8.7					
WM1	1403-1423	14.5	Surface	26.8	26.8	26.8	7.1	7.1	7.1	28.0	28.0	28.0	5.8	5.7	5.8	84.6	83.1	83.9	4.8	4.8	4.8	7.4	7.6	7.5						
			Middle	26.8	26.7	26.8	7.0	7.1	7.1	28.1	28.1	28.1	5.5	5.6	5.6	80.4	81.8	81.1	4.6	4.7	4.7	4.8	7.2	7.4	7.3	7.5				
			Bottom	26.6	26.7	26.7	7.1	7.1	7.1	28.4	28.3	28.4	5.3	5.3	5.3	78.7	78.6	78.7	4.9	4.9	4.9		7.8	7.8	7.8					
WM2	1435-1455	5.7	Surface	26.8	26.7	26.8	7.1	7.0	7.1	27.9	28.0	28.0	5.9	6.0	6.0	86.0	87.5	86.8	4.6	4.7	4.7	7.4	7.4	7.4						
			Middle																			4.7								7.5
			Bottom	26.7	26.7	26.7	7.1	7.1	7.1	28.0	28.1	28.1	5.8	5.9	5.9	84.6	86.1	85.4	4.7	4.7	4.7		7.6	7.6	7.6					
WM3	1506-1527	9.7	Surface	26.8	26.8	26.8	7.0	7.1	7.1	28.0	27.9	28.0	5.9	5.9	5.9	86.1	86.0	86.1	4.7	4.6	4.7	7.4	7.2	7.3						
			Middle	26.7	26.8	26.8	7.1	7.1	7.1	28.0	28.1	28.1	5.6	5.5	5.6	81.8	80.4	81.1	4.8	4.7	4.8	4.8	7.6	7.4	7.5	7.5				
			Bottom	26.7	26.6	26.7	7.1	7.2	7.2	28.3	28.3	28.3	5.3	5.4	5.4	78.5	80.0	79.3	4.8	4.9	4.9		7.6	7.8	7.7					
WM4	1537-1557	10.3	Surface	26.8	26.7	26.8	7.1	7.1	7.1	27.9	27.9	27.9	6.0	5.9	6.0	87.5	86.1	86.8	4.5	4.4	4.5	7.0	7.0	7.0						
			Middle	26.7	26.7	26.7	7.2	7.2	7.2	28.0	28.0	28.0	5.5	5.6	5.6	80.3	81.7	81.0	4.6	4.7	4.7	4.6	7.4	7.4	7.4	7.3				
			Bottom	26.6	26.7	26.7	7.1	7.2	7.2	28.3	28.4	28.4	5.3	5.3	5.3	78.5	78.5	78.5	4.7	4.8	4.8		7.6	7.6	7.6					
CS2	1610-1630	14.5	Surface	26.8	26.8	26.8	7.0	7.1	7.1	27.9	28.0	28.0	5.5	5.6	5.6	80.3	81.7	81.0	4.8	4.8	4.8	7.6	7.6	7.6						
			Middle	26.7	26.6	26.7	7.1	7.2	7.2	28.1	28.0	28.1	5.3	5.2	5.3	77.4	76.0	76.7	4.9	5.0	5.0	5.0	7.8	8.2	8.0	7.9				
			Bottom	26.6	26.6	26.6	7.1	7.1	7.1	28.4	28.3	28.4	4.7	4.8	4.8	69.7	71.1	70.4	5.1	5.1	5.1		8.0	8.2	8.1					

Remark or Observation:

Note: * Average

** Depth Average

SIL(E) Water Quality Monitoring Data Record Sheet

Date: 25-Oct-13
 Tide: Mid-Flood
 Weather: Fine
 Sea Conditions: Small Wave
 Upstream Control Station CS2

Location	Sampling Time	Water Depth (m)	Monitoring Depth	Temperature (°C)			pH			Salinity (ppt)			DO (mg/l)			DO Saturation (%)			Turbidity (NTU)				Suspended Solids (mg/l)						
				1	2	Ave.*	1	2	Ave.*	1	2	Ave.*	1	2	Ave.*	1	2	Ave.*	1	2	Ave.*	D.A.**	1	2	Ave.*	D.A.**			
CS1	1235	11.2	Surface	26.1	26.1	26.1	7.0	7.0	7.0	27.8	27.8	27.8	5.6	5.5	5.6	80.8	79.4	80.1	4.7	4.7	4.7	7.4	7.4	7.4					
			Middle	26.0	25.9	26.0	7.1	7.2	7.2	27.9	28.0	28.0	5.4	5.3	5.4	78.0	76.5	77.3	4.9	4.8	4.9	4.8	7.8	7.6	7.7	7.6			
			Bottom	25.8	25.7	25.8	7.1	7.1	7.1	28.0	28.1	28.1	5.1	5.0	5.1	73.5	72.1	72.8	4.8	4.9	4.9		7.6	7.8	7.7				
WM1	1205	14.6	Surface	26.0	26.1	26.1	7.0	7.1	7.1	27.7	27.8	27.8	6.0	6.1	6.1	86.5	87.9	87.2	4.6	4.5	4.6	7.2	7.2	7.2					
			Middle	25.9	26.0	26.0	7.1	7.1	7.1	27.9	27.9	27.9	5.9	5.9	5.9	85.3	85.4	85.4	4.8	4.7	4.8	4.7	7.6	7.4	7.5	7.4			
			Bottom	25.8	25.8	25.8	7.2	7.1	7.2	28.0	28.1	28.1	5.7	5.6	5.7	82.1	80.6	81.4	4.8	4.8	4.8		7.6	7.6	7.6				
WM2	1132	5.6	Surface	26.1	26.0	26.1	7.2	7.1	7.2	27.8	27.7	27.8	6.1	6.1	6.1	87.9	88.0	88.0	4.6	4.6	4.6	7.2	7.4	7.3					
			Middle																		4.6						7.4		
			Bottom	26.0	26.0	26.0	7.2	7.2	7.2	27.9	28.0	28.0	5.7	5.8	5.8	82.0	83.5	82.8	4.7	4.6	4.7		7.4	7.4	7.4				
WM3	1102	9.8	Surface	26.0	26.0	26.0	7.1	7.1	7.1	27.8	27.7	27.8	6.1	6.1	6.1	88.0	88.1	88.1	4.5	4.5	4.5	7.0	7.2	7.1					
			Middle	25.9	25.8	25.9	7.0	7.1	7.1	27.9	28.0	28.0	5.8	5.9	5.9	83.8	85.3	84.6	4.7	4.6	4.7	4.6	7.4	7.2	7.3	7.3			
			Bottom	25.8	25.7	25.8	7.2	7.1	7.2	28.0	28.1	28.1	5.6	5.7	5.7	80.7	82.2	81.5	4.7	4.7	4.7		7.6	7.6	7.6				
WM4	1031	10.7	Surface	26.1	26.0	26.1	7.0	7.1	7.1	27.7	27.7	27.7	6.0	6.1	6.1	86.5	88.0	87.3	4.4	4.5	4.5	6.8	7.0	6.9					
			Middle	25.9	25.9	25.9	7.2	7.1	7.2	28.0	27.9	28.0	5.7	5.7	5.7	82.3	82.4	82.4	4.6	4.6	4.6	4.6	7.2	7.4	7.3	7.3			
			Bottom	25.7	25.8	25.8	7.2	7.2	7.2	28.1	28.1	28.1	5.5	5.4	5.5	79.2	77.8	78.5	4.7	4.8	4.8		7.6	7.6	7.6				
CS2	1000	14.8	Surface	26.1	26.0	26.1	7.1	7.1	7.1	27.7	27.8	27.8	5.8	5.9	5.9	83.7	85.1	84.4	4.8	4.8	4.8	7.6	7.6	7.6					
			Middle	26.0	25.9	26.0	7.0	7.1	7.1	27.9	28.0	28.0	5.5	5.4	5.5	79.5	78.0	78.8	5.0	4.9	5.0	5.0	7.8	7.8	7.8	7.8			
			Bottom	25.7	25.8	25.8	7.2	7.1	7.2	28.0	28.1	28.1	5.0	5.1	5.1	72.1	73.5	72.8	5.2	5.1	5.2		8.2	8.0	8.1				

Remark or Observation:

Note: * Average

** Depth Average

SIL(E) Water Quality Monitoring Data Record Sheet

Date: 25-Oct-13
 Tide: Mid-Ebb
 Weather: Fine
 Sea Conditions: Small Wave
 Upstream Control Station CS1

Location	Sampling Time	Water Depth (m)	Monitoring Depth	Temperature (°C)			pH			Salinity (ppt)			DO (mg/l)			DO Saturation (%)			Turbidity (NTU)				Suspended Solids (mg/l)							
				1	2	Ave.*	1	2	Ave.*	1	2	Ave.*	1	2	Ave.*	1	2	Ave.*	1	2	Ave.*	D.A.**	1	2	Ave.*	D.A.**				
CS1	1445	11.0	Surface	26.2	26.1	26.2	7.0	7.1	7.1	27.7	27.8	27.8	5.4	5.3	5.4	77.9	76.5	77.2	4.8	4.9	4.9	7.6	7.8	7.7						
			Middle	26.0	26.0	26.0	7.1	7.1	7.1	28.0	27.9	28.0	5.2	5.1	5.2	75.1	73.7	74.4	5.0	5.0	5.0	5.0	7.8	8.0	7.9	7.9				
			Bottom	25.8	25.7	25.8	7.0	7.1	7.1	28.1	28.1	28.1	4.9	5.0	5.0	70.7	72.1	71.4	5.1	5.2	5.2		8.2	8.2	8.2					
WM1	1515	14.3	Surface	26.1	26.0	26.1	7.2	7.1	7.2	27.8	27.8	27.8	5.8	5.9	5.9	83.7	85.2	84.5	4.7	4.7	4.7	7.4	7.6	7.5						
			Middle	26.0	25.9	26.0	7.2	7.1	7.2	28.0	27.9	28.0	5.7	5.6	5.7	82.3	80.9	81.6	4.8	4.8	4.8	4.8	7.6	7.8	7.7	7.6				
			Bottom	25.8	25.8	25.8	7.1	7.1	7.1	28.1	28.8	28.5	5.4	5.3	5.4	77.8	76.4	77.1	4.9	4.8	4.9		7.8	7.6	7.7					
WM2	1545	5.4	Surface	26.1	26.1	26.1	7.0	7.1	7.1	27.9	27.8	27.9	5.9	5.8	5.9	85.0	83.5	84.3	4.7	4.8	4.8				7.4	7.6	7.5			
			Middle																			4.8								7.7
			Bottom	26.0	26.1	26.1	7.1	7.1	7.1	28.0	28.0	28.0	5.6	5.5	5.6	80.6	79.2	79.9	4.8	4.9	4.9		7.8	7.8	7.8					
WM3	1605	9.6	Surface	26.0	26.1	26.1	7.0	7.1	7.1	27.7	27.8	27.8	5.9	5.9	5.9	85.2	85.1	85.2	4.6	4.6	4.6	7.2	7.4	7.3						
			Middle	25.9	25.9	25.9	7.1	7.2	7.2	27.9	28.0	28.0	5.7	5.6	5.7	82.4	80.9	81.7	4.7	4.8	4.8	4.7	7.4	7.6	7.5	7.5				
			Bottom	25.7	25.8	25.8	7.1	7.1	7.1	28.1	28.0	28.1	5.4	5.3	5.4	77.9	76.4	77.2	4.8	4.8	4.8		7.6	7.8	7.7					
WM4	1620	10.5	Surface	26.1	26.1	26.1	7.1	7.0	7.1	27.8	27.7	27.8	5.7	5.8	5.8	82.2	83.7	83.0	4.6	4.7	4.7	7.2	7.4	7.3						
			Middle	25.9	25.8	25.9	7.1	7.1	7.1	27.9	27.9	27.9	5.5	5.5	5.5	79.4	79.5	79.5	4.8	4.9	4.9	4.8	7.6	7.8	7.7	7.6				
			Bottom	25.7	25.7	25.7	7.2	7.1	7.2	28.1	28.0	28.1	5.3	5.2	5.3	76.5	75.0	75.8	4.7	4.9	4.8		7.8	7.6	7.7					
CS2	1635	14.6	Surface	26.1	26.0	26.1	7.1	7.1	7.1	27.7	27.8	27.8	5.6	5.7	5.7	80.7	82.3	81.5	4.8	4.8	4.8	7.6	7.6	7.6						
			Middle	25.9	26.0	26.0	7.0	7.1	7.1	27.9	28.0	28.0	5.3	5.2	5.3	76.6	75.1	75.9	4.9	4.8	4.9	4.9	7.8	7.6	7.7	7.7				
			Bottom	25.8	25.7	25.8	7.2	7.1	7.2	28.1	28.1	28.1	4.9	4.9	4.9	70.6	70.7	70.7	4.9	4.9	4.9		7.8	7.8	7.8					

Remark or Observation:

Note: * Average

** Depth Average

SIL(E) Water Quality Monitoring Data Record Sheet

Date: 28-Oct-13
 Tide: Mid-Flood
 Weather: Fine
 Sea Conditions: Small Wave
 Upstream Control Station CS2

Location	Sampling Time	Water Depth (m)	Monitoring Depth	Temperature (°C)			pH			Salinity (ppt)			DO (mg/l)			DO Saturation (%)			Turbidity (NTU)				Suspended Solids (mg/l)			
				1	2	Ave.*	1	2	Ave.*	1	2	Ave.*	1	2	Ave.*	1	2	Ave.*	1	2	Ave.*	D.A.**	1	2	Ave.*	D.A.**
CS1	1330	11.0	Surface	25.7	25.7	25.7	7.2	7.2	7.2	25.8	25.9	25.9	5.9	5.8	5.9	84.0	83.2	83.6	4.6	4.5	4.6	7.2	7.4	7.3		
			Middle	25.7	25.7	25.7	7.2	7.2	7.2	26.1	26.2	26.2	5.9	5.8	5.9	83.7	83.3	83.5	3.3	3.3	3.3	3.7	5.2	5.2	5.2	5.9
			Bottom	25.6	25.6	25.6	7.3	7.3	7.3	26.2	26.2	26.2	5.7	5.7	5.7	81.1	81.7	81.4	3.2	3.2	3.2		5.2	5.4	5.3	
WM1	1357	11.8	Surface	25.7	25.7	25.7	7.5	7.5	7.5	26.2	26.2	26.2	5.0	5.0	5.0	72.2	72.0	72.1	2.9	2.9	2.9		4.6	4.6	4.6	
			Middle	25.7	25.7	25.7	7.5	7.5	7.5	26.2	26.2	26.2	5.2	5.2	5.2	74.8	74.5	74.7	2.6	2.6	2.6	2.8	4.2	4.2	4.2	4.5
			Bottom	25.7	25.7	25.7	7.6	7.6	7.6	26.2	26.2	26.2	5.2	5.2	5.2	74.5	74.8	74.7	2.9	3.0	3.0		4.6	4.8	4.7	
WM2	1430	5.8	Surface	25.7	25.8	25.8	7.6	7.6	7.6	26.2	26.2	26.2	5.3	5.3	5.3	75.8	75.4	75.6	3.1	3.1	3.1		4.8	5.0	4.9	
			Middle																		3.1					5.0
			Bottom	25.7	25.7	25.7	7.7	7.7	7.7	26.2	26.2	26.2	5.1	5.1	5.1	73.3	73.0	73.2	3.1	3.1	3.1		5.0	5.0	5.0	
WM3	1500	8.8	Surface	25.7	25.7	25.7	7.7	7.7	7.7	26.3	26.3	26.3	5.2	5.2	5.2	74.4	74.8	74.6	3.5	3.5	3.5		5.4	5.6	5.5	
			Middle	25.6	25.6	25.6	7.7	7.7	7.7	26.4	26.4	26.4	5.5	5.5	5.5	79.1	78.8	79.0	3.1	3.1	3.1	3.3	5.0	5.0	5.0	5.3
			Bottom	25.6	25.6	25.6	7.7	7.7	7.7	26.4	26.4	26.4	5.5	5.5	5.5	78.6	78.3	78.5	3.4	3.4	3.4		5.4	5.4	5.4	
WM4	1536	9.2	Surface	25.6	25.6	25.6	7.7	7.7	7.7	26.4	26.4	26.4	5.7	5.7	5.7	83.9	83.5	83.7	3.6	3.6	3.6		5.8	5.6	5.7	
			Middle	25.6	25.6	25.6	7.7	7.7	7.7	26.4	26.4	26.4	5.7	5.7	5.7	83.4	83.2	83.3	3.0	3.0	3.0	3.2	4.8	4.8	4.8	5.1
			Bottom	25.6	25.6	25.6	7.7	7.7	7.7	26.4	26.4	26.4	5.8	5.8	5.8	84.4	84.2	84.3	3.0	2.9	3.0		4.8	4.6	4.7	
CS2	1610	14.8	Surface	25.7	25.7	25.7	7.7	7.7	7.7	26.4	26.4	26.4	6.8	6.8	6.8	96.4	96.0	96.2	5.0	5.0	5.0		7.8	7.8	7.8	
			Middle	25.6	25.6	25.6	7.7	7.7	7.7	26.5	26.5	26.5	6.6	6.6	6.6	93.8	93.5	93.7	4.7	4.7	4.7	4.8	7.4	7.4	7.4	7.6
			Bottom	25.5	25.5	25.5	7.7	7.7	7.7	26.5	26.4	26.5	6.5	6.5	6.5	92.6	92.8	92.7	4.8	4.8	4.8		7.8	7.6	7.7	

Remark or Observation:

Note: * Average

** Depth Average

SIL(E) Water Quality Monitoring Data Record Sheet

Date: 28-Oct-13
 Tide: Mid-Ebb
 Weather: Fine
 Sea Conditions: Small Wave
 Upstream Control Station CS1

Location	Sampling Time	Water Depth (m)	Monitoring Depth	Temperature (°C)			pH			Salinity (ppt)			DO (mg/l)			DO Saturation (%)			Turbidity (NTU)				Suspended Solids (mg/l)						
				1	2	Ave.*	1	2	Ave.*	1	2	Ave.*	1	2	Ave.*	1	2	Ave.*	1	2	Ave.*	D.A.**	1	2	Ave.*	D.A.**			
CS1	1845	10.4	Surface	25.7	25.6	25.7	7.1	7.2	7.2	25.8	25.8	25.8	5.6	5.5	5.6	79.7	78.9	79.3	4.8	4.7	4.8	7.4	7.4	7.4					
			Middle	25.6	25.5	25.6	7.2	7.1	7.2	26.0	26.1	26.1	5.6	5.6	5.6	78.7	79.0	78.9	3.5	3.6	3.6	3.9	5.6	5.8	5.7	6.2			
			Bottom	25.5	25.5	25.5	7.2	7.3	7.3	26.2	26.1	26.2	5.4	5.3	5.4	76.8	76.2	76.5	3.4	3.5	3.5		5.4	5.6	5.5				
WM1	1910	11.6	Surface	25.6	25.6	25.6	7.4	7.3	7.4	26.1	26.0	26.1	4.8	4.9	4.9	69.3	70.0	69.7	3.1	3.1	3.1	4.8	4.4	4.6					
			Middle	25.6	25.5	25.6	7.4	7.5	7.5	26.1	26.1	26.1	5.0	5.1	5.1	66.9	67.5	67.2	2.8	2.7	2.8	3.0	4.4	4.4	4.4	4.7			
			Bottom	25.4	25.5	25.5	7.5	7.6	7.6	26.1	26.2	26.2	5.1	5.0	5.1	73.0	72.6	72.8	3.1	3.2	3.2		5.0	5.0	5.0				
WM2	1935	5.4	Surface	25.6	25.7	25.7	7.5	7.5	7.5	26.1	26.1	26.1	5.0	5.1	5.1	71.5	72.1	71.8	3.3	3.2	3.3								
			Middle																			3.2							
			Bottom	25.6	25.5	25.6	7.6	7.5	7.6	26.1	26.2	26.2	4.8	4.9	4.9	68.9	69.6	69.3	3.2	3.1	3.2		5.2	5.0	5.1				
WM3	2000	8.2	Surface	25.6	25.5	25.6	7.6	7.6	7.6	26.3	26.2	26.3	4.9	5.0	5.0	70.1	70.8	70.5	3.8	3.7	3.8	6.0	5.8	5.9					
			Middle	25.5	25.5	25.5	7.6	7.7	7.7	26.3	26.3	26.3	5.2	5.3	5.3	74.8	75.5	75.2	3.3	3.2	3.3	3.5	5.2	5.2	5.2	5.6			
			Bottom	25.4	25.5	25.5	7.7	7.7	7.7	26.3	26.4	26.4	5.3	5.3	5.3	75.7	75.0	75.4	3.6	3.6	3.6		5.8	5.8	5.8				
WM4	2025	8.8	Surface	25.5	25.5	25.5	7.6	7.6	7.6	26.3	26.3	26.3	5.4	5.5	5.5	79.4	80.3	79.9	3.8	3.9	3.9	6.0	6.2	6.1					
			Middle	25.4	25.5	25.5	7.6	7.7	7.7	26.3	26.4	26.4	5.3	5.3	5.3	77.5	76.8	77.2	3.3	3.2	3.3	3.5	5.4	5.2	5.3	5.6			
			Bottom	25.5	25.4	25.5	7.7	7.6	7.7	26.4	26.4	26.4	5.4	5.5	5.5	79.2	80.0	79.6	3.3	3.3	3.3		5.4	5.4	5.4				
CS2	2055	14.4	Surface	25.5	25.5	25.5	7.6	7.5	7.6	26.4	26.3	26.4	6.4	6.5	6.5	91.3	92.1	91.7	5.2	5.3	5.3	8.0	8.0	8.0					
			Middle	25.4	25.4	25.4	7.5	7.6	7.6	26.5	26.4	26.5	6.4	6.3	6.4	90.9	90.0	90.5	4.9	4.8	4.9	5.1	7.6	7.8	7.7	7.9			
			Bottom	25.3	25.4	25.4	7.6	7.7	7.7	26.5	26.5	26.5	6.2	6.3	6.3	88.9	89.6	89.3	5.0	5.1	5.1		7.8	8.0	7.9				

Remark or Observation:

Note: * Average

** Depth Average

SIL(E) Water Quality Monitoring Data Record Sheet

Date: 30-Oct-13
 Tide: Mid-Flood
 Weather: Fine
 Sea Conditions: Small Wave
 Upstream Control Station CS2

Location	Sampling Time	Water Depth (m)	Monitoring Depth	Temperature (°C)			pH			Salinity (ppt)			DO (mg/l)			DO Saturation (%)			Turbidity (NTU)				Suspended Solids (mg/l)			
				1	2	Ave.*	1	2	Ave.*	1	2	Ave.*	1	2	Ave.*	1	2	Ave.*	1	2	Ave.*	D.A.**	1	2	Ave.*	D.A.**
CS1	1540	11.2	Surface	25.9	26.0	26.0	7.1	7.1	7.1	28.3	28.4	28.4	6.1	6.2	6.2	87.8	89.0	88.4	4.5	4.6	4.6	7.0	7.4	7.2		
			Middle	25.8	25.9	25.9	7.1	7.1	7.1	28.4	28.5	28.5	6.0	6.1	6.1	86.9	87.2	87.1	4.4	4.4	4.4	4.5	7.0	7.2	7.1	7.2
			Bottom	25.7	25.8	25.8	7.1	7.1	7.1	28.5	28.6	28.6	6.2	6.2	6.2	89.6	89.8	89.7	4.5	4.6	4.6		7.2	7.4	7.3	
WM1	1505	14.6	Surface	26.0	26.0	26.0	7.1	7.1	7.1	28.4	28.5	28.5	6.2	6.2	6.2	89.0	89.9	89.5	3.8	3.7	3.8	6.0	5.8	5.9		
			Middle	25.7	25.7	25.7	7.1	7.1	7.1	28.5	28.6	28.6	6.2	6.3	6.3	89.8	90.4	90.1	4.3	4.2	4.3	3.9	7.0	6.8	6.9	6.2
			Bottom	25.6	25.6	25.6	7.0	7.1	7.1	28.7	28.8	28.8	6.3	6.3	6.3	90.6	90.4	90.5	3.6	3.7	3.7		5.8	6.0	5.9	
WM2	1431	5.8	Surface	25.9	26.0	26.0	7.0	7.1	7.1	28.0	28.1	28.1	6.1	6.1	6.1	88.0	88.4	88.2	3.4	3.5	3.5	5.4	5.6	5.5		
			Middle																			3.7				5.9
			Bottom	25.8	25.9	25.9	7.0	7.1	7.1	28.0	28.0	28.0	6.2	6.3	6.3	89.6	90.4	90.0	3.8	3.9	3.9		6.0	6.4	6.2	
WM3	1359	9.8	Surface	25.9	25.9	25.9	7.1	7.0	7.1	28.4	28.4	28.4	6.4	6.4	6.4	92.3	92.7	92.5	4.2	4.1	4.2	6.8	6.6	6.7		
			Middle	25.9	25.8	25.9	7.0	7.0	7.0	28.5	28.6	28.6	6.3	6.4	6.4	90.9	92.0	91.5	4.0	4.1	4.1	4.1	6.4	6.6	6.5	6.6
			Bottom	25.8	25.8	25.8	7.1	7.1	7.1	28.6	28.7	28.7	6.4	6.4	6.4	92.7	92.6	92.7	4.1	4.2	4.2		6.6	6.8	6.7	
WM4	1331	10.4	Surface	26.0	26.0	26.0	7.1	7.1	7.1	28.3	28.4	28.4	6.3	6.3	6.3	90.7	90.9	90.8	4.5	4.6	4.6	7.2	7.2	7.2		
			Middle	25.9	25.9	25.9	7.0	7.1	7.1	28.4	28.5	28.5	6.3	6.2	6.3	90.5	89.8	90.2	3.8	3.9	3.9	4.1	6.0	6.2	6.1	6.5
			Bottom	25.8	25.7	25.8	7.0	7.0	7.0	28.5	28.6	28.6	6.4	6.4	6.4	92.0	92.4	92.2	3.9	3.8	3.9		6.2	6.2	6.2	
CS2	1300	14.8	Surface	26.0	26.0	26.0	7.0	7.1	7.1	28.2	28.3	28.3	6.2	6.2	6.2	89.5	89.6	89.6	4.0	4.0	4.0	6.2	6.4	6.3		
			Middle	25.9	25.8	25.9	7.0	7.0	7.0	28.5	28.4	28.5	6.1	6.1	6.1	88.3	88.5	88.4	4.3	4.4	4.4	4.4	6.8	7.0	6.9	7.0
			Bottom	25.8	25.7	25.8	7.0	7.1	7.1	28.6	28.7	28.7	6.0	6.0	6.0	86.2	86.8	86.5	4.9	4.9	4.9		7.8	8.0	7.9	

Remark or Observation:

Note: * Average

** Depth Average

SIL(E) Water Quality Monitoring Data Record Sheet

Date: 30-Oct-13
 Tide: Mid-Ebb
 Weather: Fine
 Sea Conditions: Small Wave
 Upstream Control Station CS1

Location	Sampling Time	Water Depth (m)	Monitoring Depth	Temperature (°C)			pH			Salinity (ppt)			DO (mg/l)			DO Saturation (%)			Turbidity (NTU)				Suspended Solids (mg/l)							
				1	2	Ave.*	1	2	Ave.*	1	2	Ave.*	1	2	Ave.*	1	2	Ave.*	1	2	Ave.*	D.A.**	1	2	Ave.*	D.A.**				
CS1	0830	10.8	Surface	25.8	25.8	25.8	7.2	7.1	7.2	28.2	28.3	28.3	6.0	6.0	6.0	86.6	86.4	86.5	4.7	4.7	4.7					7.4	7.6	7.5		
			Middle	25.7	27.6	26.7	7.1	7.0	7.1	28.4	28.5	28.5	6.2	6.2	6.2	89.3	89.7	89.5	5.0	5.0	5.0	5.0					7.8	7.8	7.8	7.9
			Bottom	25.7	25.6	25.7	7.0	7.0	7.0	28.8	28.8	28.8	6.3	6.4	6.4	90.7	92.2	91.5	5.2	5.3	5.3					8.4	8.4	8.4		
WM1	0900	14.0	Surface	25.9	25.8	25.9	7.1	7.1	7.1	28.3	28.4	28.4	6.3	6.3	6.3	90.1	90.9	90.5	4.0	4.1	4.1					6.2	6.4	6.3		
			Middle	25.6	25.6	25.6	7.1	7.1	7.1	28.5	28.5	28.5	6.2	6.2	6.2	89.7	89.9	89.8	3.9	3.9	3.9	3.9					6.2	6.2	6.2	6.2
			Bottom	25.6	25.5	25.6	7.1	7.1	7.1	28.6	28.7	28.7	6.3	6.2	6.3	90.2	89.8	90.0	3.8	3.7	3.8					6.2	6.0	6.1		
WM2	0930	5.4	Surface	25.8	25.8	25.8	7.0	7.0	7.0	27.9	27.9	27.9	6.2	6.2	6.2	89.4	89.6	89.5	3.9	3.8	3.9					6.2	6.0	6.1		
			Middle																			4.0							6.4	
			Bottom	25.7	25.6	25.7	7.1	7.1	7.1	28.0	28.1	28.1	6.2	6.3	6.3	89.9	90.2	90.1	4.1	4.1	4.1					6.6	6.6	6.6		
WM3	0958	9.0	Surface	25.9	25.8	25.9	7.0	7.0	7.0	28.3	28.2	28.3	6.4	6.3	6.4	92.0	90.9	91.5	4.3	4.4	4.4					6.6	7.0	6.8		
			Middle	25.8	25.8	25.8	7.0	7.1	7.1	28.4	28.4	28.4	6.3	6.2	6.3	90.4	89.8	90.1	4.2	4.3	4.3	4.2					6.6	6.8	6.7	6.7
			Bottom	25.7	25.7	25.7	7.1	7.1	7.1	28.4	28.5	28.5	6.4	6.3	6.4	91.7	90.8	91.3	4.0	4.1	4.1					6.4	6.6	6.5		
WM4	1027	10.2	Surface	25.9	25.9	25.9	7.2	7.1	7.2	28.2	28.2	28.2	6.3	6.3	6.3	90.2	90.8	90.5	4.5	4.6	4.6					7.0	7.4	7.2		
			Middle	25.7	25.8	25.8	7.0	7.1	7.1	28.3	28.4	28.4	6.4	6.4	6.4	92.2	92.4	92.3	3.5	3.6	3.6	4.0					5.6	6.0	5.8	6.4
			Bottom	25.7	25.6	25.7	7.1	7.1	7.1	28.3	28.4	28.4	6.3	6.3	6.3	90.0	90.8	90.4	3.8	3.8	3.8					6.2	6.2	6.2		
CS2	1110	14.2	Surface	25.8	25.7	25.8	7.1	7.1	7.1	28.2	28.3	28.3	6.0	6.0	6.0	86.8	86.9	86.9	4.9	4.8	4.9					7.8	7.6	7.7		
			Middle	25.8	25.8	25.8	7.1	7.2	7.2	28.4	28.4	28.4	6.2	6.1	6.2	89.1	88.5	88.8	4.7	4.6	4.7	4.9					7.6	7.4	7.5	7.8
			Bottom	25.6	25.6	25.6	7.1	7.1	7.1	28.6	28.6	28.6	6.3	6.4	6.4	90.3	91.2	90.8	5.1	5.1	5.1					8.2	8.0	8.1		

Remark or Observation:

Note: * Average

** Depth Average

APPENDIX E

Review of Exceedance in Environmental Monitoring

Sampling Date	Tidal Mode	Parameter			Remarks
		DO	Turbidity	SS	
2 Oct 2013	Mid-Ebb & Mid-Flood	AL, LL	-	-	<p>Exceedances of Action/ Limit Levels were recorded along all monitoring stations (WM1–WM4) at all water levels (surface, middle & bottom) for both mid-flood and mid-ebb tides, except surface level at WM1 during the mid-flood tide.</p> <p>The exceedances have been investigated and were considered not related to the project works as DO levels were low among all monitoring stations, including the control stations. Also, the silt curtain has been inspected and was functioned properly. As such, the natural fluctuation of the marine water quality has been considered attributed to the low DO levels.</p>
4 Oct 2013	Mid-Ebb & Mid-Flood	AL, LL	-	-	<p>Exceedances of Action/ Limit Levels were recorded along all monitoring stations (WM1–WM4) at all water levels (surface, middle & bottom) for both mid-flood and mid-ebb tides.</p> <p>The exceedances have been investigated and were considered not related to the project works as DO levels were low among all monitoring stations, including the control stations. Also, the silt curtain has been inspected and was functioned properly. As such, the natural fluctuation of the marine water quality has been considered attributed to the low DO levels.</p>
7 Oct 2013	Mid-Ebb & Mid-Flood	AL, LL	-	-	<p>Exceedances of Action/ Limit Levels were recorded along all monitoring stations (WM1–WM4) at all water levels (surface, middle & bottom) during mid-ebb tide, except surface level at WM1, WM3 & WM4 during mid-flood tide and surface level at surface level at WM1 during mid-ebb tide.</p> <p>The exceedances have been investigated and were considered not related to the project works as DO levels were low among all monitoring stations, including the control stations. Also, the silt curtain has been inspected and was functioned properly. As such, the natural fluctuation of the marine water quality has been considered attributed to the low DO levels.</p>

Sampling Date	Tidal Mode	Parameter			Remarks
		DO	Turbidity	SS	
11 Oct 2013	Mid-Ebb & Mid-Flood	AL, LL	-	-	<p>Exceedances of Action/ Limit Levels were recorded along all monitoring stations (WM1, WM2, WM3 & WM4) at all water levels (surface, middle & bottom) for both mid-flood and mid-ebb tides, except surface level at WM1-WM4 & middle level at WM3 during mid-flood tide and surface level at WM1-WM3 during mid-ebb tide.</p> <p>The exceedances have been investigated and were considered not related to the project works as DO levels were low among all monitoring stations, including the control stations. Also, the silt curtain has been inspected and was functioned properly. As such, the natural fluctuation of the marine water quality has been considered attributed to the low DO levels.</p>
15 Oct 2013	Mid-Ebb & Mid-Flood	AL, LL	-	-	<p>Exceedances of Action/ Limit Levels were recorded along all monitoring stations (WM1, WM2, WM3 & WM4) at all water levels (surface, middle & bottom) for both mid-flood and mid-ebb tides.</p> <p>The exceedances have been investigated and were considered not related to the project works as DO levels were low among all monitoring stations, including the control stations. Also, the silt curtain has been inspected and was functioned properly. As such, the natural fluctuation of the marine water quality has been considered attributed to the low DO levels.</p>
17 Oct 2013	Mid-Ebb & Mid-Flood	AL, LL	-	-	<p>Exceedances of Action/ Limit Levels were recorded along all monitoring stations (WM1, WM2, WM3 & WM4) at all water levels (surface, middle & bottom) for both mid-flood and mid-ebb tides, except surface level at WM1-WM4 during mid-flood tide and surface level at WM1 during mid-ebb tide.</p> <p>The exceedances have been investigated and were considered not related to the project works as DO levels were low among all monitoring stations, including the control stations. Also, the silt curtain has been inspected and was functioned properly. As such, the natural fluctuation of the marine water quality has been considered attributed to the low DO levels.</p>

Sampling Date	Tidal Mode	Parameter			Remarks
		DO	Turbidity	SS	
19 Oct 2013	Mid-Ebb & Mid-Flood	AL, LL	-	-	<p>Exceedances of Action/ Limit Levels were recorded along all monitoring stations (WM1, WM2, WM3 & WM4) at all water levels (surface, middle & bottom) for both mid-flood and mid-ebb tides.</p> <p>The exceedances have been investigated and were considered not related to the project works as DO levels were low among all monitoring stations, including the control stations. Also, the silt curtain has been inspected and was functioned properly. As such, the natural fluctuation of the marine water quality has been considered attributed to the low DO levels.</p>
21 Oct 2013	Mid-Ebb & Mid-Flood	AL, LL	-	-	<p>Exceedances of Action/ Limit Levels were recorded along all monitoring stations (WM1, WM2, WM3 & WM4) at all water levels (surface, middle & bottom) for both mid-flood and mid-ebb tides.</p> <p>The exceedances have been investigated and were considered not related to the project works as DO levels were low among all monitoring stations, including the control stations. Also, the silt curtain has been inspected and was functioned properly. As such, the natural fluctuation of the marine water quality has been considered attributed to the low DO levels.</p>
23 Oct 2013	Mid-Ebb & Mid-Flood	AL, LL	-	-	<p>Exceedances of Action/ Limit Levels were recorded along all monitoring stations (WM1, WM2, WM3 & WM4) at all water levels (surface, middle & bottom) for both mid-flood and mid-ebb tides, except surface level at WM1-WM4 during mid-flood tide.</p> <p>The exceedances have been investigated and were considered not related to the project works as DO levels were low among all monitoring stations, including the control stations. Also, the silt curtain has been inspected and was functioned properly. As such, the natural fluctuation of the marine water quality has been considered attributed to the low DO levels.</p>

Sampling Date	Tidal Mode	Parameter			Remarks
		DO	Turbidity	SS	
25 Oct 2013	Mid-Ebb & Mid-Flood	AL, LL	-	-	<p>Exceedances of Action/ Limit Levels were recorded along all monitoring stations (WM1, WM2, WM3 & WM4) at all water levels (surface, middle & bottom) for both mid-flood and mid-ebb tides, except surface level at WM1-WM4 during mid-flood tide and surface level at WM2 during mid-ebb tide..</p> <p>The exceedances have been investigated and were considered not related to the project works as DO levels were low among all monitoring stations, including the control stations. Also, the silt curtain has been inspected and was functioned properly. As such, the natural fluctuation of the marine water quality has been considered attributed to the low DO levels.</p>
28 Oct 2013	Mid-Ebb & Mid-Flood	AL, LL	-	-	<p>Exceedances of Action/ Limit Levels were recorded along all monitoring stations (WM1, WM2, WM3 & WM4) at all water levels (surface, middle & bottom) for both mid-flood and mid-ebb tides.</p> <p>The exceedances have been investigated and were considered not related to the project works as DO levels were low among all monitoring stations, including the control stations. Also, the silt curtain has been inspected and was functioned properly. As such, the natural fluctuation of the marine water quality has been considered attributed to the low DO levels.</p>
30 Oct 2013	Mid-Ebb	AL	-	-	<p>Exceedance of Action Level was recorded at monitoring station WM4 at bottom level during mid-ebb tide.</p> <p>The exceedances have been investigated and were considered not related to the project works as exceedance was recorded only at WM4 (bottom level) and no exceedance was recorded at other monitoring stations. Also, the silt curtain has been inspected and was functioned properly. As such, the natural fluctuation of the marine water quality has been considered attributed to the low DO levels.</p>

Note: AL – Action Level ; LL – Limit Level

Remarks:

APPENDIX F

Implementation of Environmental Mitigation Measures

EIA Ref.	EM&A Ref.	Recommended Mitigation Measures	Objectives of the Recommended Measure & Main Concerns to address	Who to implement the measure?	Location of the measure	When to implement the measure?	What requirements or standards for the measure to achieve?	Implementation status
Noise Impact (Construction Phase)								
<i>Airborne</i>								
3.4.1.4	2	Adoption of Quieter PME The recommended quieter PME adopted in the assessment were taken from the BS5228: Part 1:2009 and are presented in Table 3.20 . It should be noted that the silenced PME selected for assessment can be found in Hong Kong.	To minimize the construction air-borne noise impact	Contractors	Construction Work Sites	During Construction	EIAO and NCO	Being implemented
3.4.1.4	2	Use of Movable Noise Barrier The use of movable barrier for certain PME can further alleviate the construction noise impacts. In general, a 5 dB(A) reduction for movable PME and 10 dB(A) for stationary PME can be achieved depending on the actual design of the movable noise barrier. The Contractor shall be responsible for design of the movable noise barrier with due consideration given to the size of the PME and the requirement for intercepting the line of sight between the NSRs and PME. Barrier material with surface mass in excess of 7 kg/m ² is recommended to achieve the predicted screening effect.	To minimize the construction air-borne noise impact	Contractors	Construction Work Sites	During Construction	EIAO and NCO	Being implemented
3.4.1.4	2	Use of Noise Enclosure/ Acoustic Shed The use of noise enclosure or acoustic shed is to cover stationary PME such as air compressor and concrete pump. With the adoption of the noise enclosure, the PME could be completely screened, and noise reduction of 15 dB(A) can be achieved according to the GW-TM.	To minimize the construction air-borne noise impact	Contractors	Construction Work Sites	During Construction	EIAO and NCO	Being implemented
3.4.1.4	2	Use of Silencer To reduce noise emission from the ventilation fans, silencers are also recommended to be used in fan ventilation system to attenuate noise generated during fan operation to achieve a noise reduction of 15 dB(A).	To minimize the construction air-borne noise impact	Contractors	Construction Work Sites	During Construction	EIAO and NCO	Being implemented

Appendix F Implementation of Environmental Mitigation Measures

EIA Ref.	EM&A Ref.	Recommended Mitigation Measures	Objectives of the Recommended Measure & Main Concerns to address	Who to implement the measure?	Location of the measure	When to implement the measure?	What requirements or standards for the measure to achieve?	Implementation status
3.4.1.4	2	<p>Use of Noise Insulating Fabric</p> <p>Noise insulating fabric (the Fabric) can also be adopted for certain PME (e.g. drill rig, pilling auger etc). The Fabric should be lapped such that there are no openings or gaps on the joints. Technical data from manufacturers state that by using the Fabric, a noise reduction of over 10 dB(A) can be achieved on noise level.</p>	To minimize the construction air-borne noise impact	Contractors	Construction Work Sites	During Construction	EIAO and NCO	Being implemented
3.4.1.4	2	<p>Good Site Practice</p> <p>The good site practices listed below should be followed during each phase of construction:</p> <ul style="list-style-type: none"> • Only well-maintained plant should be operated on-site and plant should be serviced regularly during the construction programme; • Silencers or mufflers on construction equipment should be utilized and properly maintained during the construction programme; • Mobile plant, if any, should be sited as far from NSRs as possible; • Machines and plant (such as trucks) that may be in intermittent use should be shut down between work periods or should be throttled down to a minimum; • Plant known to emit noise strongly in one direction should, wherever possible, be orientated so that the noise is directed away from the nearby NSRs; and • Material stockpiles and other structures should be effectively utilized, wherever practicable, in screening noise from on-site construction activities. 	To minimize the construction air-borne noise impact	Contractors	Construction Work Sites	During Construction	EIAO and NCO	Being implemented
<i>Ground-borne</i>								
3.4.2.5	2	PME that is in intermittent use should be shut down between work periods or should be throttled down to a minimum.	To minimize the construction ground-borne noise impact	Contractors	Tunnel site near Lei Tung Station	During Construction	NCO	To be implemented as per construction programme

EIA Ref.	EM&A Ref.	Recommended Mitigation Measures	Objectives of the Recommended Measure & Main Concerns to address	Who to implement the measure?	Location of the measure	When to implement the measure?	What requirements or standards for the measure to achieve?	Implementation status
Noise Impact (Operation Phase)								
<i>Airborne</i>								
<u>Railway Noise</u>								
3.5.1.1	2	Erection of noise barrier/ enclosure along the viaduct section as shown in Table 3.52 and illustrated in Figures 3.25 to 3.27 . For the 'Further Mitigation Measures for Existing and Planned NSRs', additional noise barriers/semi-enclosures have been recommended for viaduct sections shown in Table 3.57 and illustrated in Figure 3.28 to 3.30 . The viaduct structure should allow further installation of noise barrier or enclosure at the later commissioning stage, if required.	To minimize the railway airborne noise along the viaduct section of SIL(E)	MTRC / Contractor	West of ex-Canadian Hospital site, West of Ocean Park G/IC site, East and West of Wong Chuk Hang Residential Zone, along Wong Chuk Hang Nullah and along Ap Lei Chau Bridge as shown in Figure 3.25 to Figure 3.30.	Before Operation	EIAO and NCO	To be implemented as per construction programme
<u>Fixed Plant Noise</u>								
3.5.1.2	2	The following noise reduction measures shall be considered as far as practicable during construction: <ul style="list-style-type: none"> Choose quieter plant such as those which have been effectively silenced; Include noise levels specification when ordering new plant (including chillier and E/M equipment); Locate fixed plant/louver away from any NSRs as far as practicable; Locate fixed plant in walled plant rooms or in specially designed enclosures; Locate noisy machines in a basement or a completely separate building; Install direct noise mitigation measures including silencers, acoustic louvers and acoustic enclosure where necessary; and Develop and implement a regularly scheduled plant maintenance programme so that equipment is properly operated and serviced in order to maintain a controlled level of noise. 	To minimize the fixed plant noise impact	MTRC	All stations, entrances, and ventilation buildings	Before Operation	EIAO and NCO	To be implemented as per construction programme

Appendix F Implementation of Environmental Mitigation Measures

EIA Ref.	EM&A Ref.	Recommended Mitigation Measures	Objectives of the Recommended Measure & Main Concerns to address	Who to implement the measure?	Location of the measure	When to implement the measure?	What requirements or standards for the measure to achieve?	Implementation status
<i>Ground-borne</i>								
3.5.2.3	2	Using of incline turnout (a 5 dB(A) reduction in turnout and crossing vibration) and Type 1a resilient baseplated trackform within the SOH station.	To minimize the railway ground-borne noise impact	MTRC / Contractor	South Horizons Station	Before Operation	EIAO and NCO	To be implemented as per construction programme
Ecological Impact (Construction Phase)								
<i>Habitat Loss</i>								
4.7.1	3	Minimise habitat loss particularly woodland as far as possible.	Minimize habitat loss	Contractors	Construction Work Sites	During Construction	Annex 16 of EIAO-TM	Being implemented
4.7.1	3	Temporary disturbed woodland should be reinstated in full after the completion of works	To reinstate disturbed woodland habitats	Contractors	Construction Work Sites	After completion of construction works	Annex 16 of EIAO-TM; ETWB TCW No. 2/2004 (for maintenance arrangement of vegetation)	To be implemented as per construction programme
4.7.1	3	Degraded woodland and shrubland should be reinstated after the completion of works as far as possible.	To reinstate disturbed habitats	Contractors	Construction Work Sites	After completion of construction works	Annex 16 of EIAO-TM; ETWB TCW No. 2/2004 (for maintenance arrangement of vegetation)	To be implemented as per construction programme
4.7.1	3	Habitat Compensation of permanent loss of woodland in full in terms of area.	To compensate permanent loss of woodland	Contractors	Construction Work Sites	After completion of construction works	Annex 16 of EIAO-TM; ETWB TCW No. 2/2004 (for maintenance arrangement of vegetation)	To be implemented as per construction programme
<i>Ardeid Night Roost</i>								
4.7.2.1	3	Avoidance of Site Clearance and Tree Felling Works at Wintering Season Site clearance and tree felling works at the existing ardeid night roost (location described in Figure 4.15) should only be carried out at non-wintering season (March to November inclusive). Demarcating clearly the works area and ensuring good site practise to avoid unnecessary disturbance to the ardeids during construction phase.	Avoid and minimize impact on peak period of ardeid roosting	Contractor	Construction Work Sites	During Construction	Annex 16 of EIAO-TM	Being implemented

EIA Ref.	EM&A Ref.	Recommended Mitigation Measures	Objectives of the Recommended Measure & Main Concerns to address	Who to implement the measure?	Location of the measure	When to implement the measure?	What requirements or standards for the measure to achieve?	Implementation status
4.7.2.1 and 4.7.2.4	3	Compensate for loss of roosting trees with replanting of suitable trees The compensatory planting with suitable, heavy standard trees should be located at the lower course of the WCH Nullah approximately 200m west of the existing night roost (location shown in Figure 4.15). Trees should be replanted after construction alongside the nullah to provide a substrate for roosting.	To compensate for permanent loss of roosting trees	Contractors, advised by Ecologist	Construction Work Site at Wong Chuk Hang	After completion of construction works	Annex 16 of EIAO-TM; ETWB TCW No. 2/2004 (for maintenance arrangement of vegetation)	To be implemented as per construction programme
4.7.2.1	3	Inspection of ardeid night roost for active ardeid nests When conducting site clearance works at the existing ardeid night roost, the area should be inspected to confirm no active ardeid nest are present. If any active bird nest is observed, suitably sized buffer area should be established to minimize human or machinery disturbance until the nest is abandoned. Also the site should be monitored monthly to check the updated status.	Ensure no impact on active ardeid nests	Contractors, advised by Ecologist	Construction Work Site at Wong Chuk Hang	During Construction	Wild Animals Protection Ordinance (Cap. 170)	Being implemented
4.7.2.2	3	Avoidance of Construction Activities at Sunset Time Construction activities using PME at the potential ardeid night roost (location shown in Figure 4.13) should be ceased at 18:00 – 06:00 to avoid disturbance to the night roost ardeids.	Minimize noise impact on ardeid roosting and foraging	Contractor	Construction Work Sites	During Construction	Annex 16 of EIAO-TM	Being implemented
4.7.2.4	3	Coloured Panels on Noise Barriers The acoustic enclosure/ barrier should be designed with coloured panels to minimize the chance of bird collision.	To minimise the potential for bird strike	Contractors	Construction Work Sites	During Construction	Annex 16 of EIAO-TM;	To be implemented as per construction programme
4.7.3	3	Magazine Site Implement good site practice including containment of silt runoff within the site boundary, containment of contaminated soils, appropriate storage of chemicals and wastes.	Avoid impacts to fauna species and water pollution	Contractor	Chung Hom Shan Magazine Site	During Construction	ProPECC Note PN 1/94 Waste Disposal Ordinance (Cap.354)	Implemented

EIA Ref.	EM&A Ref.	Recommended Mitigation Measures	Objectives of the Recommended Measure & Main Concerns to address	Who to implement the measure?	Location of the measure	When to implement the measure?	What requirements or standards for the measure to achieve?	Implementation status
4.7.4	3	Coral Community at Aberdeen Channel A bridge pier construction method in which a cofferdam would be installed to create a confined dredging environment should be implemented to minimise potential impacts from suspended solid release. Good site practices should be applied to land-based construction works including containment of silt runoff within the site boundary, the containment of contaminated soils for removal from the site and appropriate storage of chemicals and chemical waste.	Avoid release of suspended solid and contaminated runoff to Aberdeen Channel	Contractors	Dredging/ excavation area required for installation of the pier/pier foundations of bridge in Aberdeen Channel	During marine construction works	WQOs & ProPECC Note PN 1/94	Being implemented
4.7.5	3	Floral Species of Conservation Interest Transplanting all affected floral species of conservation interest identified in the EcolA. <i>In-situ</i> preservation should be re-considered throughout all stages of the project.	Mitigate the removal impact on floral species of conservation interest	Contractors	Construction Work Sites	During Construction	Annex 16 of EIAO-TM;	Being implemented
Water Quality Impact (Construction)								
5.7.1.1	4	Dredging/ Excavation and Seawall modification for construction of piers/pier foundations of bridge in Aberdeen Channel To minimise the loss of fine sediment to suspension, steel pile casing and watertight cofferdam should be installed and seawater trapped inside the casing and cofferdam should be pumped out to generate a dry working environment prior to carrying out sediment dredging/ excavation. The water from the dewatering should be appropriately treated with desilting or sedimentation device before discharge. Silt curtains should be deployed to completely enclose the cofferdam installation and removal works and the seawall modification and pile installation works respectively.	Avoid spillage of sediment	MTRC / Contractor	Dredging/ excavation area required for installation of the pier/pier foundations of bridge in Aberdeen Channel	During marine construction works	WQOs & ProPECC Note PN 1/94	Being implemented

EIA Ref.	EM&A Ref.	Recommended Mitigation Measures	Objectives of the Recommended Measure & Main Concerns to address	Who to implement the measure?	Location of the measure	When to implement the measure?	What requirements or standards for the measure to achieve?	Implementation status
5.7.1.2	4	<p>Barging Facilities and Activities</p> <p>To minimise the release of suspended solids to marine waters, silt curtain should be deployed to completely enclose the marine piles works during installation and decommissioning. Good site practices for operation of barging points should be followed, including appropriate sizing of vessels to ensure adequate clearance between the vessel and the seabed, controlled loading and unloading of barges and hoppers to prevent splash, installing tight fitting seals to the bottom openings to prevent leakage, and measures to prevent foam, oil, grease, scum or litter on the water within the site.</p>	To minimize suspended solids and water quality impacts	MTRC / Contractor	Barging point marine works area	During marine construction works	WQOs & ProPECC Note PN 1/94	Being implemented
5.7.1.3	4	<p>Sewage Effluent from Construction Workforce</p> <p>Temporary sanitary facilities, such as portable chemical toilets, should be employed on-site where necessary to handle sewage from the workforce. A licensed contractor should be employed to provide appropriate and adequate portable toilets and be responsible for appropriate disposal and maintenance.</p>	To minimize water quality impacts	MTRC / Contractor	All works areas with on-site sanitary facilities	During Construction	Water Pollution Control Ordinance	Being implemented
5.7.1.4	4	<p>Wastewater Discharge from Tunnelling and Open Cut Excavation</p> <p>Wastewater with a high level of suspended solids should be treated before discharge by settlement in tanks with sufficient retention time. Oil interceptors would be required to remove the oil, lubricants and grease from wastewater. Should the level of suspended solids be very high, an on-site pre-packaged treatment plant might be required with the addition of flocculants to improve the settlement of solids. A discharge licence under the WPCO would be required for discharge to stormwater drain.</p>	To minimize water quality impacts	MTRC / Contractor	All works areas	During Construction	Water Pollution Control Ordinance	Being implemented
5.7.1.5	4	<p>Construction Site Runoff and Drainage</p> <p>The site practices outlined in ProPECC Note PN 1/94 should be followed as far as practicable in order to minimise surface runoff and the chance of erosion. The following measures are recommended to protect water quality and sensitive uses of the coastal area i.e. WSD seawater intakes along the Aberdeen Channel:</p>	To minimize water quality impacts	MTRC / Contractor	All works areas	During Construction	ProPECC Note PN 1/94	Being implemented

EIA Ref.	EM&A Ref.	Recommended Mitigation Measures	Objectives of the Recommended Measure & Main Concerns to address	Who to implement the measure?	Location of the measure	When to implement the measure?	What requirements or standards for the measure to achieve?	Implementation status
		<ul style="list-style-type: none"> • At the start of site establishment (including the barging facilities), perimeter cut-off drains to direct off-site water around the site should be constructed with internal drainage works and erosion and sedimentation control facilities implemented. Channels (both temporary and permanent drainage pipes and culverts), earth bunds or sand bag barriers should be provided on site to direct stormwater to silt removal facilities. The design of the temporary on-site drainage system should be undertaken by the Contractor prior to the commencement of construction. • The dikes or embankments for flood protection should be implemented around the boundaries of earthwork areas. Temporary ditches should be provided to facilitate the runoff discharge into stormwater drainage system through a sediment/silt trap. The sediment/silt traps should be incorporated in the permanent drainage channels to enhance deposition rates, if practical. • Sand/silt removal facilities such as sand/silt traps and sediment basins should be provided to remove sand/silt particles from runoff to meet the requirements of the TM standards under the WPCO. The design of efficient silt removal facilities should be based on the guidelines in Appendix A1 of ProPECC Note PN 1/94. Sizes may vary depending upon the flow rate. The detailed design of the sand/silt traps should be undertaken by the Contractor prior to the commencement of construction. 						

EIA Ref.	EM&A Ref.	Recommended Mitigation Measures	Objectives of the Recommended Measure & Main Concerns to address	Who to implement the measure?	Location of the measure	When to implement the measure?	What requirements or standards for the measure to achieve?	Implementation status
		<ul style="list-style-type: none"> • All drainage facilities and erosion and sediment control structures should be regularly inspected and maintained to ensure proper and efficient operation at all times and particularly during rainstorms. Deposited silt and grit should be regularly removed, at the onset of and after each rainstorm to ensure that these facilities are functioning properly at all times. • Measures should be taken to minimize the ingress of site drainage into excavations. If excavation of trenches in wet periods is necessary, they should be dug and backfilled in short sections wherever practicable. Water pumped out from foundation excavations should be discharged into storm drains via silt removal facilities. • If surface excavation works cannot be avoided during the wet season (April to September), temporarily exposed slope/soil surfaces should be covered by tarpaulin or other means, as far as practicable, and temporary access roads should be protected by crushed stone or gravel, as excavation proceeds. Interception channels should be provided (e.g. along the crest/edge of the excavation) to prevent storm runoff from washing across exposed soil surfaces. • The overall slope of the site should be kept to a minimum to reduce the erosive potential of surface water flows. 						

EIA Ref.	EM&A Ref.	Recommended Mitigation Measures	Objectives of the Recommended Measure & Main Concerns to address	Who to implement the measure?	Location of the measure	When to implement the measure?	What requirements or standards for the measure to achieve?	Implementation status
		<ul style="list-style-type: none"> • All vehicles and plant should be cleaned before leaving a construction site to ensure no earth, mud, debris and the like is deposited by them on roads. An adequately designed and sited wheel washing facility should be provided at construction site exit where practicable. Wash-water should have sand and silt settled out and removed regularly to ensure the continued efficiency of the process. The section of access road leading to, and exiting from, the wheel-wash bay to the public road should be paved with sufficient backfall toward the wheel-wash bay to prevent vehicle tracking of soil and silty water to public roads and drains. • Open stockpiles of construction materials or construction wastes on-site should be covered with tarpaulin or similar fabric during rainstorms. Measures should be taken to prevent the washing away of construction materials, soil, silt or debris into any drainage system. • Manholes (including newly constructed ones) should be adequately covered and temporarily sealed so as to prevent silt, construction materials or debris being washed into the drainage system and stormwater runoff being directed into foul sewers. • Precautions should be taken at any time of the year when rainstorms are likely. Actions should be taken when a rainstorm is imminent or forecasted and actions to be taken during or after rainstorms are summarized in Appendix A2 of ProPECC Note PN 1/94. Particular attention should be paid to the control of silty surface runoff during storm events, especially for areas located near steep slopes. 						

EIA Ref.	EM&A Ref.	Recommended Mitigation Measures	Objectives of the Recommended Measure & Main Concerns to address	Who to implement the measure?	Location of the measure	When to implement the measure?	What requirements or standards for the measure to achieve?	Implementation status
		<ul style="list-style-type: none"> Bentonite slurries used in piling or slurry walling should be reconditioned and reused wherever practicable. Temporary enclosed storage locations should be provided on-site for any unused bentonite that needs to be transported away after all the related construction activities are completed. The requirements in ProPECC Note PN 1/94 should be adhered to in the handling and disposal of bentonite slurries. 						
5.7.1.6	4	<p>General Construction Activities</p> <p>Construction solid waste, debris and refuse generated on-site should be collected, handled and disposed of properly to avoid entering any nearby stormwater drain. Stockpiles of cement and other construction materials should be kept covered when not being used.</p> <p>Oils and fuels should only be stored in designated areas which have pollution prevention facilities. To prevent spillage of fuels and solvents to any nearby stormwater drain, all fuel tanks and storage areas should be provided with locks and be sited on sealed areas, within bunds of a capacity equal to 110% of the storage capacity of the largest tank. The bund should be drained of rainwater after a rain event.</p>	To minimize water quality impacts	MTRC / Contractor	All works areas	During Construction	EIA Recommendation	Being implemented
Water Quality Impact (Operation)								
5.7.2.1	4	<p>Change in flow regime and hydrology in Aberdeen Channel (Typhoon Shelter) (ATS) due to railway bridge</p> <p>Streamline shaped bridge pier to reduce friction to the tidal flows across the Aberdeen Channel should been considered in the conceptual design of the bridge form.</p>	To minimize water quality impacts	MTRC / Detailed Design Consultant	Pier/pier foundations of bridge in Aberdeen Channel	During Detailed Design	EIA Recommendation	Implemented

EIA Ref.	EM&A Ref.	Recommended Mitigation Measures	Objectives of the Recommended Measure & Main Concerns to address	Who to implement the measure?	Location of the measure	When to implement the measure?	What requirements or standards for the measure to achieve?	Implementation status
5.7.2.3	4	<p>Sewage and wastewater effluents from stations and depot</p> <ul style="list-style-type: none"> • Runoff and spillage prevention measures should conform to relevant engineering and design standards. Any opportunities for the recycling of water within the automatic washing facilities should be sought to minimise discharge requirements. Bio-degradable detergents should be selected to minimise the impact on water quality and associated ecosystems of the receiving water bodies. • Plant maintenance areas should be bunded and constructed on an impermeable floor, and provided with petrol interceptors. Traps and interceptors should be regularly cleaned and maintained, especially after any accidental spillages. Layers of sawdust, sand or equivalent material should be laid underneath and around any plant and equipment that may possibly leak oil. • An emergency spillage action plan should be developed for the Depot to ensure that any accidental spillage event is treated immediately and does not impact on any water bodies. • All fuel tanks and storage areas within the Depot should be provided with locks and be located on sealed areas, within bunds of a capacity equal to 110% of the storage capacity of the largest tank, to prevent the escape of spilled fuel oils. • Waste oil and other chemicals must be disposed by a licensed contractor to either the approved Chemical Waste Treatment Centre, or another licensed facility, in accordance with the Waste Disposal (Chemical Waste) (General) Regulation (Cap 354). 	To minimize water quality impacts	MTRC	SIL(E) Stations & WCH Depot	During Operation	WPCO	To be implemented as per construction programme

EIA Ref.	EM&A Ref.	Recommended Mitigation Measures	Objectives of the Recommended Measure & Main Concerns to address	Who to implement the measure?	Location of the measure	When to implement the measure?	What requirements or standards for the measure to achieve?	Implementation status
5.7.2.4	4	<p>Runoff from rail tracks</p> <ul style="list-style-type: none"> Track drainage channels discharge should pass through oil/grit interceptors/chambers to remove oil, grease and sediment before being pumped to the public stormwater drainage system. Silt traps and oil interceptors should be cleaned and maintained regularly. Oily contents of the oil interceptors should be transferred to an appropriate disposal facility, or to be collected for reuse, if possible. 	To minimize water quality impacts	MTRC	Along the SIL(E) tracks	During Operation	WPCO	To be implemented as per construction programme
Landscape and Visual Impact (Construction Phase)								
Table 6-13	Preservation of Existing Vegetation							
CP1.1	5	To retain trees, which have high amenity or ecology value and contribute most to the landscape and visual amenity of the site and its immediate environs.	To minimise the disturbance to the existing landscape resources.	Project Landscape Architect (Detailed Design Consultants)/ Contractor	Site	Throughout design phase	TM-EIA Annex 18, ETWB TCW No. 3/2006 & 2/2004	Implemented
CP1.2	5	Creation of precautionary area around trees to be retained equal to half of the trees canopy diameter. Precautionary area to be fenced.	To ensure the success of the tree preservation proposals.	Contractor	Site	Before construction phase commence	TM-EIA Annex 18, ETWB TCW No. 3/2006 & 2/2004	Implemented
CP1.3	5	Prohibition of the storage of materials including fuel, the movement of construction vehicles, and the refuelling and washing of equipment including concrete mixers within the precautionary area.	To ensure the success of the tree preservation proposals.	Contractor	Site	Throughout construction phase	TM-EIA Annex 18, ETWB TCW No. 3/2006 & 2/2004	Being implemented
CP1.4	5	Phased segmental root pruning for trees to be retained and transplanted over a suitable period (determined by species and size) prior to lifting or site formation works which affect the existing rootball of trees identified for retention. The extent of the pruning will be based on the size and the species of the tree in each case.	To ensure the success of the tree preservation proposals.	Contractor	Site	Throughout construction phase	TM-EIA Annex 18, ETWB TCW No. 3/2006 & 2/2004	Being implemented
CP1.5	5	Pruning of the branches of existing trees identified for transplantation and retention to be based on the principle of crown thinning maintaining their form and amenity value.	To ensure the success of the tree preservation proposals.	Contractor	Site	Throughout construction phase	TM-EIA Annex 18, ETWB TCW No. 3/2006 & 2/2004	Being implemented

Appendix F Implementation of Environmental Mitigation Measures

EIA Ref.	EM&A Ref.	Recommended Mitigation Measures	Objectives of the Recommended Measure & Main Concerns to address	Who to implement the measure?	Location of the measure	When to implement the measure?	What requirements or standards for the measure to achieve?	Implementation status
CP1.6	5	The watering of existing vegetation particularly during periods of excavation when the water table beneath the existing vegetation is lowered.	To ensure the success of the tree preservation proposals.	Contractor	Site	Throughout construction phase	TM-EIA Annex 18, ETWB TCW No. 3/2006 & 2/2004	Being implemented
CP1.7	5	The rectification and repair of damaged vegetation following the construction phase to it's original condition prior to the commencement of the works or replacement using specimens of the same species, size and form where appropriate to the design intention of the area affected	To ensure the success of the tree preservation proposals.	Contractor	Site	Throughout construction phase	TM-EIA Annex 18, ETWB TCW No. 3/2006 & 2/2004	To be implemented as per construction programme
CP1.8	5	All works affecting the trees identified for retention and transplanted will be carefully monitored. This includes the key stages in the preparation of the trees, the implementation of protection measures and health monitoring through out the construction period	To ensure the success of the tree preservation proposals.	Contractor	Site	Throughout construction phase	TM-EIA Annex 18, ETWB TCW No. 3/2006 & 2/2004	Being implemented
CP1.9	5	Detailed landscape and tree preservation proposals will be submitted to the relevant government departments for approval under the lease conditions and in accordance with ETWB TCW No. 2/2004 and 3/2006.	To ensure the tree preservation and planting proposals are integrated with the existing landscape context and that the landscape resources are preserved where appropriate.	Project Landscape Architect (Detailed Design Consultants)	Site	Throughout design phase	TM-EIA Annex 18, ETWB TCW No. 3/2006 & 2/2004	Implemented
CP1.10	5	The tree preservation works should be implemented. A tree protection specification would be included within the contract documents.	To ensure the tree preservation and planting proposals are integrated with the existing landscape context and that the landscape resources are preserved where appropriate.	Project Proponent	Site	Throughout design and construction phases	TM-EIA Annex 18, ETWB TCW No. 3/2006 & 2/2004	Implemented
Table 6-13	Works Area and Temporary Works Areas							
CP2.1	5	Where appropriate to the final design the landscape of these works areas should be restored following the completion of the construction phase.	To minimise the disturbance to existing landscape resources and change of visual amenity.	Contractor	Site	Through out construction phase	TM-EIA Annex 18	To be implemented as per construction programme

Appendix F Implementation of Environmental Mitigation Measures

EIA Ref.	EM&A Ref.	Recommended Mitigation Measures	Objectives of the Recommended Measure & Main Concerns to address	Who to implement the measure?	Location of the measure	When to implement the measure?	What requirements or standards for the measure to achieve?	Implementation status
CP2.2	5	Construction site controls should be enforced including the storage of materials, the location and appearance of site accommodation and the careful design of site lighting to prevent light spillage.	To minimise the disturbance to existing landscape resources and change of visual amenity.	Contractor	Site	Through out construction phase	TM-EIA Annex 18	Being implemented
CP2.3	5	Screen the works area during the construction phase through the use of decorative hoarding along the site boundary facing adjacent VSRs	To minimise the disturbance to existing landscape resources and change of visual amenity.	Contractor	Site	Through out construction phase	TM-EIA Annex 18	Being implemented
Table 6-13	Implementation of Mitigation Planting and planting species selection							
CP3.1	5	Replanting of disturbed vegetation should be undertaken at the earliest possible stage of the construction phase.	To minimise the disturbance to existing landscape resources and minimize the impacts on the visual amenity of the area.	Contractor	Site	After the site formation and on completion of planting area.	TM-EIA Annex 18, ETWB TCW No. 3/2006 & 2/2004	Being implemented
CP3.2	5	Use of native plant species predominantly in the planting design for the buffer areas.	To enhance the local landscape and ecological value.	Project Landscape Architect (Detailed Design Consultants)	Site	After the site formation and on completion of planting area.	TM-EIA Annex 18, ETWB TCW No. 3/2006 & 2/2004	Being implemented
CP3.3	5	Proposed mitigation planting shall not only limit to conventional amenity planting, but also considered alternative greening measures such as vertical greening for screening or soften the built structures. Small shrubs, climbing plants, grass and groundcovers shall be used in specific locations according to site condition and at where would not interfere the operation of railway and its associated facilities.	To maximise the planting opportunities	Project Landscape Architect (Detailed Design Consultants)	Site	Throughout design and construction phases	TM-EIA Annex 18, ETWB TCW No. 3/2006 & 2/2004	Being implemented
CP3.4	5	The tree planting works should be implemented by approved Landscape Contractors and inspected and approved on site by a qualified Landscape Architect. A tree planting specification would be included within the contract documents.	To ensure the tree preservation and planting proposals are integrated with the existing landscape context and that valuable landscape	Project Proponent	Site	Throughout design and construction phases	TM-EIA Annex 18, ETWB TCW No. 3/2006 & 2/2004	Being implemented

EIA Ref.	EM&A Ref.	Recommended Mitigation Measures	Objectives of the Recommended Measure & Main Concerns to address	Who to implement the measure?	Location of the measure	When to implement the measure?	What requirements or standards for the measure to achieve?	Implementation status
Table 6-13		Transplantation of Existing Trees						
CP4.1	5	The tree transplanting works should be implemented by approved Landscape Contractors and inspected and approved on site by a qualified Landscape Architect. A tree protection / transplanting specification would be included within the contract documents.	To ensure the tree preservation and planting proposals are integrated with the existing landscape context and that valuable landscape resources are preserved where appropriate to the final design.	Project Proponent / Contractor	Site	Throughout design and construction phases	TM-EIA Annex 18, ETWB TCW No. 3/2006 & 2/2004	Being implemented
CP4.2	5	Approximately 437 existing trees to be transplanted, majority of them shall be relocated to off-site planting areas. The final recipient sites should be, as far as space allows, adjacent to their current locations alongside of the alignment.	To retain their contribution to the local landscape context.	Project Landscape Architect (Detailed Design Consultants)/ Contractor / Project Proponent (planting areas associated with station and alignment)/ LCSD (roadside and park areas)	Site	Throughout design and construction phases	TM-EIA Annex 18, ETWB TCW No. 3/2006 & 2/2004	Being implemented
CP4.3	5	Tree to be transplanted to planting areas identified in the "Southern District Greening Master Plan" shall be, as far as programme allows, directly relocated to their final recipient sites.	To minimise the disturbance to the landscape resources.	Project Landscape Architect (Detailed Design Consultants)/ Contractor / Project Proponent (planting areas associated with station and alignment)/ LCSD (roadside and park areas)	Site	Throughout design and construction phases	TM-EIA Annex 18, ETWB TCW No. 3/2006 & 2/2004	Being implemented
CP4.4	5	Tree to be replanted along the alignment shall be kept in the temporary holding nurseries which closely monitoring by landscape contractor.	To enhance the survivals of the transplanted trees	Project Landscape Architect (Detailed Design Consultants)/ Contractor	Site	Throughout design and construction phases	TM-EIA Annex 18, ETWB TCW No. 3/2006 & 2/2004	Being implemented

Appendix F Implementation of Environmental Mitigation Measures

EIA Ref.	EM&A Ref.	Recommended Mitigation Measures	Objectives of the Recommended Measure & Main Concerns to address	Who to implement the measure?	Location of the measure	When to implement the measure?	What requirements or standards for the measure to achieve?	Implementation status
CP4.5	5	The implementation programme for the proposed works should reserve enough time for the advance tree transplanting preparation works.	To enhance the survivals of the transplanted trees	Project Proponent/ Project Landscape Architect (Detailed Design Consultants)/ Contractor	Site	Throughout design and construction phases	TM-EIA Annex 18, ETWB TCW No. 3/2006 & 2/2004	Being implemented
CP4.6	5	The implementation programme for the proposed works should reserve enough time for the advance tree transplanting preparation works.	To enhance the survivals of the transplanted trees	Project Proponent/ Project Landscape Architect (Detailed Design Consultants)/ Contractor	Site	Throughout design and construction phases	TM-EIA Annex 18, ETWB TCW No. 3/2006 & 2/2004	Being implemented
CP4.7	5	The tree transplanting works should be implemented by approved Landscape Contractors and inspected and approved on site by a qualified Landscape Architect. A tree protection specification would be included within the contract documents.	To enhance the survivals of the transplanted trees	Project Proponent/ Project Landscape Architect (Detailed Design Consultants)/ Contractor	Site	Throughout design and construction phases	TM-EIA Annex 18, ETWB TCW No. 3/2006 & 2/2004	Being implemented
Table 6-13		Coordination with Concurrent Projects						
CP5.1	5	Coordinated implementation programme with concurrent projects	To minimise potential impact where possible reduce the period of disturbance.	Project Proponent / Project Landscape Architect (Detailed Design Consultants)/ Contractor	Site	Throughout design and construction phases	TM-EIA Annex 18.	Being implemented
<u>Landscape and Visual Impact (Operation Phase)</u>								
Table 6-14		Design of Engineering and Building Structures						
OP1.1	5	Where possible integrate the engineering and building structures, as far as technically feasible, with existing built structures. Select responsive The locations for the associated facilities away from landscape and visually sensitive areas.	To ensure the proposals are integrated with the existing landscape and visual context, and avoid cluster effect.	Project Engineer and Architect (Detailed Design Consultants)/ NA	Site	Throughout design phase	TM-EIA Annex 18 and BD	Implemented

Appendix F Implementation of Environmental Mitigation Measures

EIA Ref.	EM&A Ref.	Recommended Mitigation Measures	Objectives of the Recommended Measure & Main Concerns to address	Who to implement the measure?	Location of the measure	When to implement the measure?	What requirements or standards for the measure to achieve?	Implementation status
OP1.2	5	Use of a responsive design for the disposition of the main elements including the locations of the proposed above ground structures.	To ensure the proposals are integrated with the existing landscape and visual context, and avoid cluster effect.	Project Engineer and Architect (Detailed Design Consultants)/ NA	Site	Throughout Design phase	TM-EIA Annex 18 and BD	Implemented
OP1.3	5	The disposition and height profile of the proposed ground structures should respond to the existing context.	To enhance the sense of visual integration with the existing context, avoid abrupt transitions between the existing and proposed built environment and reduce the apparent visual mass of the proposed developments.	Project Engineer and Architect (Detailed Design Consultants)/ NA	Site	Throughout design phase	TM-EIA Annex 18 and BD	Implemented
OP1.4	5	Creation of setbacks, articulating the development frontage, maintenance of view corridors and the utilisation of stepped or articulated height profile.	To enhance the sense of visual integration with the existing context, avoid abrupt transitions between the existing and proposed built environment and reduce the apparent visual mass of the proposed developments.	Project Engineer and Architect (Detailed Design Consultants)/ NA	Site	Throughout design phase	TM-EIA Annex 18 and BD	Implemented
OP1.5	5	Use of natural materials such as colour blocking, innovative surface treatments and vertical greening.	To reduce the apparent visual mass of the facilities.	Project Engineer and Architect (Detailed Design Consultants)/ NA	Site	Throughout design phase	TM-EIA Annex 18, HKPSG and BD	Implemented
OP1.6	5	Use of natural materials such as colour blocking, innovative surface treatments and vertical greening.	To reduce the apparent visual mass of the facilities.	Project Engineer and Architect (Detailed Design Consultants)/ Project Proponent	Site	Throughout design phase	TM-EIA Annex 18, HKPSG and BD	Implemented
OP1.7	5	Use of natural tones colour palette and non-reflective materials for outward facing building facades finishes.	To reduce the potential glare effect.	Project Engineer and Architect (Detailed Design Consultants)/ NA	Site	Throughout design phase	TM-EIA Annex 18, HKPSG and BD	Implemented

EIA Ref.	EM&A Ref.	Recommended Mitigation Measures	Objectives of the Recommended Measure & Main Concerns to address	Who to implement the measure?	Location of the measure	When to implement the measure?	What requirements or standards for the measure to achieve?	Implementation status
OP1.8	5	Incorporation of landscaped terraced edges where conditions allow particularly those fronting the public realm.	To reduce the apparent visual mass of the structure and create a more subtle transition with the pedestrian level streetscape.	Project Engineer and Architect (Detailed Design Consultants)/ NA	Site	Throughout design phase	TM-EIA Annex 18, HKPSG and BD	Implemented
OP1.9	5	Aesthetic design of architectural and track lighting sign shall follow the following design intention. - Directional and full cut off lighting is recommended particularly for recreation and roadside areas; - Minimize geographical spread of lighting, only applied for safety at the key access points and staircases; - Limited lighting intensity to meet the minimum safety and operational requirement; and - High-pressure sodium road lighting is recommended for more stringent light control.	To reduce the night-time glare effect to the surrounding environs, reducing spillage and thus visual impacts.	Project Engineer and Architect (Detailed Design Consultants)/ NA	Site	Through out operation phase	TM-EIA Annex 18	To be implemented as per construction programme
Table 6-14		Roadside and Amenity Planting						
OP2.1	5	Utilise large ornamental trees to maximise the area of visible greenery, soften the interface between the proposed scheme and adjacent urban fabric and enhance the thermal comfort of adjacent spaces.	Provide a linkage with the existing landscape creating a more coherent landscape framework.	Project Landscape Architect(Detailed Design Consultants)/ Project Proponent	Site	Through out design phase	TM-EIA Annex 18, ETWB TCW No. 3/2006 & 2/2004, HKPSG and BD	Implemented
OP2.2	5	Planting proposals should respond to the need for visual access in the views from the adjacent neighbourhoods to the roadside or rural landscape. Whereas dense foliage plants shall be provided at other locations to screen and frame views, provide a more shaded environment for pedestrians and provide accents within the existing roadside planting.	Conserve and enhance the landscape interest.	Project Landscape Architect(Detailed Design Consultants)/ Project Proponent	Site	Through out design phase	TM-EIA Annex 18, ETWB TCW No. 3/2006 & 2/2004, HKPSG and BD	Implemented
OP2.3	5	The planting on sloping ground and areas adjacent to existing woodland shall utilise native species.	Improving the ecological connectivity between existing woodland habitats and creating a more unified and coherent landscape framework.	Project Landscape Architect(Detailed Design Consultants)/ Project Proponent	Site	Through out design phase	TM-EIA Annex 18, ETWB TCW No. 3/2006 & 2/2004, HKPSG and BD	Implemented

EIA Ref.	EM&A Ref.	Recommended Mitigation Measures	Objectives of the Recommended Measure & Main Concerns to address	Who to implement the measure?	Location of the measure	When to implement the measure?	What requirements or standards for the measure to achieve?	Implementation status
Table 6-14		Compensatory Planting Proposals						
OP3.1	5	Utilise all available spaces for new tree and shrub planting to screen views of the proposals and where this is not possible soften their architectural form.	To soften the architectural form and enhance their visual integration within the future landscape context.	Project Landscape Architect (IDC Consultants) / LCSD	Site	Through out design phase	TM-EIA Annex 18, ETWB TCW No. 3/2006 & 2/2004, HKPSG and BD	Implemented
OP3.2	5	New tree planting will be concentrated in the proposed amenity areas along the alignment and surrounding the stations, and providing infill planting between the retained and transplanted trees; and on the disturbed slope areas.	To restore and enhance existing landscape context.	Project Proponent / NA	Site	Through out design phase	TM-EIA Annex 18, ETWB TCW No. 3/2006 & 2/2004, HKPSG and BD	Implemented
OP3.3	5	The preliminary planting proposals for the proposed works shall adopt a compensatory planting ratio of 1:1 (new planting: trees recommended for felling) utilising a combination of mature to light standard sized stock in general roadside and planting areas adjacent to proposed stations and above ground structures.	To compensate the loss of existing trees.	Project Proponent / Project Landscape Architect (IDC Consultants)	Site	Through out design phase	TM-EIA Annex 18, ETWB TCW No. 3/2006 & 2/2004, HKPSG	Implemented
OP3.4	5	The retention of existing trees through their preservation in-situ, the transplantation of trees found to be in conflict with the proposed works and the successful establishment of the newly planted trees will form part of the roadside and slope planting enhancing the amenity of the local areas and providing for the thermal comfort of pedestrians.	To compensate the loss of existing trees.	Project Proponent / Project Landscape Architect (IDC Consultants)	Site	Through out design phase	TM-EIA Annex 18, ETWB TCW No. 3/2006 & 2/2004, HKPSG	Implemented
OP3.5	5	The proposed compensatory and new tree planting will utilise a combination of species native to Hong Kong and ornamental feature trees for the slope areas and those alongside the infrastructure corridors. The species selection for the areas adjacent to proposed stations and within the main urban areas will utilise a range of amenity tree species. These proposals will be subject to further development during the detailed design stage of the project.	To compensate the loss of existing trees.	Project Proponent / Project Landscape Architect (IDC Consultants)	Site	Through out design phase	TM-EIA Annex 18, ETWB TCW No. 3/2006 & 2/2004, HKPSG	Implemented

Appendix F Implementation of Environmental Mitigation Measures

EIA Ref.	EM&A Ref.	Recommended Mitigation Measures	Objectives of the Recommended Measure & Main Concerns to address	Who to implement the measure?	Location of the measure	When to implement the measure?	What requirements or standards for the measure to achieve?	Implementation status
OP3.6	5	The preliminary planting proposals for the proposed works shall adopt a compensatory planting ratio of 1:1 (new planting: trees recommended for felling) utilising a combination of mature to light standard sized stock in general roadside and planting areas adjacent to proposed stations and above ground structures.	To compensate the loss of existing trees.	Project Proponent / Project Landscape Architect (IDC Consultants)	Site	Through out design phase	TM-EIA Annex 18, ETWB TCW No. 3/2006 & 2/2004, HKPSG	Implemented
OP3.7	5	The retention of existing trees through their preservation in-situ, the transplantation of trees found to be in conflict with the proposed works and the successful establishment of the newly planted trees will form part of the roadside and slope planting enhancing the amenity of the local areas and providing for the thermal comfort of pedestrians.	To compensate the loss of existing trees.	Project Proponent / Project Landscape Architect (IDC Consultants)	Site	Through out design phase	TM-EIA Annex 18, ETWB TCW No. 3/2006 & 2/2004, HKPSG	Implemented
OP3.8	5	The proposed compensatory and new tree planting will utilise a combination of species native to Hong Kong and ornamental feature trees for the slope areas and those alongside the infrastructure corridors. The species selection for the areas adjacent to proposed stations and within the main urban areas will utilise a range of amenity tree species. These proposals will be subject to further development during the detailed design stage of the project.	To compensate the loss of existing trees.	Project Proponent / Project Landscape Architect (IDC Consultants)	Site	Through out design phase	TM-EIA Annex 18, ETWB TCW No. 3/2006 & 2/2004, HKPSG	Implemented

EIA Ref.	EM&A Ref.	Recommended Mitigation Measures	Objectives of the Recommended Measure & Main Concerns to address	Who to implement the measure?	Location of the measure	When to implement the measure?	What requirements or standards for the measure to achieve?	Implementation status
Table 6-14	5	<p>Treatment of Retaining Wall and Slopes</p> <p>The proposed treatment of Retaining Wall and Slopes should be aesthetically enhanced through the use of soft landscape works including tree and shrub planting to give man-made slopes a more natural appearance blending into the local rural landscape.</p>	<p>The design seeks to visually integrate the engineered slope feature within the local landscape context.</p>	<p>Project Landscape Architect(Detailed Design Consultants)/ / LCSD or HyD</p>	Site	Through out design phase	<p>TM-EIA Annex 18, HKPSG and BD GEO Publication No. 1/2000 "Technical Guidelines on Landscape Treatment and Bio-engineering for Man-made Slopes and Retaining Walls" For HyD SIMAR slopes refer to Standard Requirements for Handover of Vegetation on to Highway Department (Rev.B).</p>	Implemented

EIA Ref.	EM&A Ref.	Recommended Mitigation Measures	Objectives of the Recommended Measure & Main Concerns to address	Who to implement the measure?	Location of the measure	When to implement the measure?	What requirements or standards for the measure to achieve?	Implementation status
OP4.2	5	Whip sized tree planting is preferred on the face of soil cut slopes and at the crest and toe of the slope, and within berm planters. The smaller, younger plant stock will adapt to their new growing conditions more quickly than larger sized stock and establish a naturalistic effect more rapidly.	The design seeks to visually integrate the engineered slope feature within the local landscape context.	Project Landscape Architect(Detailed Design Consultants)/ / LCSD or HyD	Site	Through out design phase	TM-EIA Annex 18, HKPSG and BD GEO Publication No. 1/2000 "Technical Guidelines on Landscape Treatment and Bio-engineering for Man-made Slopes and Retaining Walls" For HyD SIMAR slopes refer to Standard Requirements for Handover of Vegetation on to Highways Department (Rev.B).	Implemented
Table 6-14 Design of Noise Mitigation Structures								
OP5.1	5	Noise mitigation structures installed along the trackside should not be limited to the functional requirements of mitigating train noise. It should also include a requirement that these structures make a positive contribution to the urban / semi-rural landscape character of this area and by doing so improve the perceived landscape quality of the area. These barriers would be visible from some VSRs identified in the study.	To ensure the proposals are integrated with the existing landscape and visual context, and avoid cluster effect.	Project Engineer and Architect (Detailed Design Consultants)/ NA	Site	Throughout design phase	TM-EIA Annex 18 and BD	Implemented
OP5.2	5	Promote the innovative use of materials, such as Plexiglas, fibreglass, reinforced concrete etc, whilst remaining aware of the design life span of each of the elements incorporated in the design.	To ensure the proposals are integrated with the existing landscape and visual context, and avoid cluster effect.	Project Engineer and Architect (Detailed Design Consultants)/ NA	Site	Throughout design phase	TM-EIA Annex 18 and BD	Implemented

Appendix F Implementation of Environmental Mitigation Measures

EIA Ref.	EM&A Ref.	Recommended Mitigation Measures	Objectives of the Recommended Measure & Main Concerns to address	Who to implement the measure?	Location of the measure	When to implement the measure?	What requirements or standards for the measure to achieve?	Implementation status
OP5.3	5	Reduce the visual effect of the structure through the use of form, materials, textures colours and tones.	To ensure the proposals are integrated with the existing landscape and visual context, and avoid cluster effect.	Project Engineer and Architect (Detailed Design Consultants)/ NA	Site	Throughout design phase	TM-EIA Annex 18 and BD	Implemented
OP5.4	5	Incorporation of articulation in the façade of the noise barriers / enclosures through the use of some transparent sections near the upper portion of the proposed structure.	To ensure the proposals are integrated with the existing landscape and visual context, and avoid cluster effect.	Project Engineer and Architect (Detailed Design Consultants)/ NA	Site	Throughout design phase	TM-EIA Annex 18 and BD	Implemented
OP5.5	5	Reflect the chromatic context of the surrounding urban landscape through the use of colour panels in the proposed noise barrier.	To ensure the proposals are integrated with the existing landscape and visual context, and avoid cluster effect.	Project Engineer and Architect (Detailed Design Consultants)/ NA	Site	Throughout design phase	TM-EIA Annex 18 and BD	Implemented
OP5.6	5	Utilise materials, which are non-reflective avoiding glare from incident sunlight.	To ensure the proposals are integrated with the existing landscape and visual context, and avoid cluster effect.	Project Engineer and Architect (Detailed Design Consultants)/ NA	Site	Throughout design phase	TM-EIA Annex 18 and BD	Implemented
Table 6-14	Design of Engineering Structures							
OP6.1	5	The landscape consultants have worked in unison with the engineers on the aesthetic aspects of the structures and their relationship with the landscape.	To ensure the proposals are integrated with the existing landscape and visual context, and avoid cluster effect.	Project Engineer and Landscape Architects (Detailed Design Consultants)/ NA	Site	Throughout design phase	TM-EIA Annex 18 and BD, ACABAS	Implemented
OP6.2	5	The structures shall aim to “touch” the ground as lightly as possible in order to minimise disturbance to the existing landscape and vegetation below the structures. This would be achieved by designing slender, rounded columns spaced the maximum distance apart. The viaducts would be constructed using pre-cast methods and launched from columns rather than scaffolding. The viaduct should be designed to achieve where appropriate a graceful, curving alignment.	To ensure the proposals are integrated with the existing landscape and visual context, and avoid cluster effect.	Project Engineer and Architect (Detailed Design Consultants)/ NA	Site	Throughout design phase	TM-EIA Annex 18 and BD, ACABAS	Implemented

Appendix F Implementation of Environmental Mitigation Measures

EIA Ref.	EM&A Ref.	Recommended Mitigation Measures	Objectives of the Recommended Measure & Main Concerns to address	Who to implement the measure?	Location of the measure	When to implement the measure?	What requirements or standards for the measure to achieve?	Implementation status
OP6.3	5	Landform and vegetation in areas disturbed by construction works would be reinstated to blend with the existing landscape patterns or as discussed above.	To ensure the proposals are integrated with the existing landscape and visual context, and avoid cluster effect.	Project Engineer and Architect (Detailed Design Consultants)/ NA	Site	Throughout design phase	TM-EIA Annex 18 and BD, ACABAS	Implemented
OP6.4	5	Wherever light levels, the water regime and the requirements of the ecological mitigation measures permit, vegetation would be reinstated below the structures. Irrigation may be required in some locations and hard landscape solutions considered where the clearance is low. Planting would be used wherever possible to minimise the apparent height of structures and to soften their appearance in medium and long distance views.	To ensure the proposals are integrated with the existing landscape and visual context, and avoid cluster effect.	Project Engineer and Architect (Detailed Design Consultants)/ NA	Site	Throughout design phase	TM-EIA Annex 18 and BD, ACABAS	Implemented
OP6.2	5	The design of the proposed structures should avoid unnecessary visual clutter, this would be achieved through the co-ordination of the various engineering disciplines involved to arrive at innovative design solutions.	To ensure the proposals are integrated with the existing landscape and visual context, and avoid cluster effect.	Project Engineer and Architect (Detailed Design Consultants)/ NA	Site	Throughout design phase	TM-EIA Annex 18 and BD, ACABAS	Implemented
OP6.5	5	Fair faced concrete would not be used for parapets to minimise glare from the structure and to avoid the visually detracting effect of staining.	To ensure the proposals are integrated with the existing landscape and visual context, and avoid cluster effect.	Project Engineer and Architect (Detailed Design Consultants)/ NA	Site	Throughout design phase	TM-EIA Annex 18 and BD, ACABAS	Implemented
OP6.6	5	Drainage structures would where possible be concealed within the structure of the proposed viaducts.	To ensure the proposals are integrated with the existing landscape and visual context, and avoid cluster effect.	Project Engineer and Architect (Detailed Design Consultants)/ NA	Site	Throughout design phase	TM-EIA Annex 18 and BD, ACABAS	Implemented
Table 6-14	Reinstatement and Creation of Open Spaces and Gardens							
OP7.1	5	The landscape consultants have worked in unison with the engineers on the aesthetic aspects for Reinstatement and Creation of Open Spaces and Gardens	To ensure the proposals are integrated with the existing landscape and visual context, and avoid cluster effect.	Project Engineer and Landscape Architects (Detailed Design Consultants)/ NA	Site	Throughout Design and Construction phases	TM-EIA Annex 18 and BD, ACABAS	Implemented

Appendix F Implementation of Environmental Mitigation Measures

EIA Ref.	EM&A Ref.	Recommended Mitigation Measures	Objectives of the Recommended Measure & Main Concerns to address	Who to implement the measure?	Location of the measure	When to implement the measure?	What requirements or standards for the measure to achieve?	Implementation status
Hazard to Life								
A7A	6	Improved truck design to reduce the amount of combustibles in, front exhaust spark arrester, 1 x 9 kg water based and 1 x 9 kg dry chemical powder fire extinguishers for a vehicle with gross weight up to 9 tonnes, and 2 x 2.5kg dry powder and 2 x 10-litre foam fire extinguishers to be provided for a vehicle of 9 tonnes and above, and a hand-held lightning detector to be provided in the vehicle. This should be combined with monthly vehicle inspection.	To meet the ALARP requirement	MTRC/ Contractor	Explosive Magazine	Construction phase		To be implemented as per construction programme
A7A	6	Blasting activities including storage and transport of explosives should be supervised and audited by competent site staff to ensure strict compliance with the blasting permit conditions.	To ensure that the risks from the proposed explosives storage and transport would not be unacceptable	MTRC / Contractor	Works areas at which explosives would be stored and/or used	Construction phase	Dangerous Goods Ordinance	To be implemented as per construction programme
A7A	6	Only the required quantity of explosives for a particular blast should be transported to avoid the return of unused explosives to the magazine. The number of return trips to the magazine with the full load of explosives or partial load should be minimised by proper co-ordination between blasting and delivery. If disposal is required for small quantities, disposal should be made in a controlled and safe manner by a Registered Shotfirer.	To reduce the risk during explosives transport	MTRC/ Contractor	Works areas at which explosives would be stored and/ or used	Construction phase		To be implemented as per construction programme
A7A	6	The explosive truck accident frequency should be minimized by implementing a dedicated training programme for both the driver and his attendants, including regular briefing sessions, implementation of a defensive driving attitude. In addition, drivers should be selected based on good safety record, and medical checks.	To meet the ALARP requirement.	MTRC/ Contractor	-	Construction phase		To be implemented as per construction programme
A7A	6	The contractor should as far as practicable combine the explosive deliveries for a given work area.	To meet the ALARP requirement.	MTRC/ Contractor	-	Construction phase		To be implemented as per construction programme

Appendix F Implementation of Environmental Mitigation Measures

EIA Ref.	EM&A Ref.	Recommended Mitigation Measures	Objectives of the Recommended Measure & Main Concerns to address	Who to implement the measure?	Location of the measure	When to implement the measure?	What requirements or standards for the measure to achieve?	Implementation status
A7A	6	The explosive truck fire involvement frequency should be minimized by implementing a better emergency response and training to make sure the adequate fire extinguishers are used and attempt is made to evacuate the area of the incident or securing the explosive load if possible. All explosive vehicles should also be equipped with bigger capacity AFFF-type extinguishers.	To meet the ALARP requirement.	MTRC/ Contractor	-	Construction phase		To be implemented as per construction programme
A7A	6	A minimum headway between two consecutive trucks conveys of at least 10 min is recommended.	To ensure that the risk from the proposed explosives transport would not be unacceptable	MTRC/ Contractor	Along explosives transport route	Construction phase		To be implemented as per construction programme
A7A	6	Use only experienced driver(s) with good safety record for explosive vehicle(s). Training should be provided to ensure it covers all major safety subjects.	To ensure safe transport of explosives	MTRC/ Contractor	At suitable location	Construction phase		To be implemented as per construction programme
A7A	6	Develop procedure to ensure that parking space on the site is available for the explosive truck. Confirmation of parking space should be communicated to truck drivers before delivery.	To ensure that the risks from the proposed explosives storage and transport would not be unacceptable	MTRC/ Contractor	Explosive magazine	Construction phase		To be implemented as per construction programme
A7A	6	Delivery vehicles shall not be permitted to remain unattended within the magazine site (or appropriately wheel-locked).	To reduce the risk of fire within the magazine	MTRC / Contractor	Explosive Magazine	Construction phase		To be implemented as per construction programme
A7A	6	Good house-keeping within and outside of the magazine to ensure that combustible materials (including vegetation) are removed and not allowed to accumulate.	To reduce the risk of fire within the magazine	MTRC / Contractor	Explosive Magazine	Construction phase		To be implemented as per construction programme
A7A	6	Detonators shall not be transported in the same vehicle with other Class 1 explosives.	To reduce the risk of explosion during the transport of cartridge emulsion	MTRC / Contractor		Construction phase		To be implemented as per construction programme
A7A	6	Emergency plan (i.e. magazine operational manual) shall be developed to address uncontrolled fire in magazine area. The case of fire near an explosive carrying truck in jammed traffic should also be covered. Drill of the emergency plan should be carried out at regular intervals.	To reduce the risk of fire	MTRC/ Contractor	Explosive Magazine and along explosives transport route	Construction phase		To be implemented as per construction programme
A7A	6	Adverse weather working guideline should be developed to clearly define procedure for transport explosives during thunderstorm.	To ensure safe transport of explosives	MTRC/ Contractor	Along explosives transport route	Construction phase		To be implemented as per construction programme

Appendix F Implementation of Environmental Mitigation Measures

EIA Ref.	EM&A Ref.	Recommended Mitigation Measures	Objectives of the Recommended Measure & Main Concerns to address	Who to implement the measure?	Location of the measure	When to implement the measure?	What requirements or standards for the measure to achieve?	Implementation status
A7A	6	During transport of the explosives within the tunnel, hot work should not be permitted.	To ensure safe transport of explosives	MTRC/ Contractor	Along explosives transport route	Construction phase		To be implemented as per construction programme
A7A	6	Ensure that UN 1.4B packaging of detonators remains intact until handed over at blasting site.	To reduce the risk of explosion during the transport of detonator	MTRC/ Contractor	-	Construction phase		To be implemented as per construction programme
A7A	6	Contractor to ensure that any electro-explosive devices are sufficiently shielded from radio frequency radiation hazards.	To reduce the risk of explosion during the transport of detonators	MTRC/ Contractor	-	Construction phase		To be implemented as per construction programme
A7A	6	Steel vehicle tray welded to a steel vertical fire screen should be mounted at least 150 mm behind the drivers cab and 100 mm from the steel cargo compartment, the vertical screen shall protrude 150 mm in excess of all three (3) sides of the steel cargo compartment.	To reduce the risk during explosives transport.	MTRC/ Contractor	-	Construction phase		To be implemented as per construction programme
A7A	6	Ensure cartridge emulsion with high water content should be preferred. Also, the emulsion with perchlorate formulation should be avoided.	To ensure safe explosives to be used	MTRC/ Contractor	-	Construction phase		To be implemented as per construction programme
A7A	6	Traffic Management should be implemented within the temporary magazine site, to ensure that no more than 1 vehicle will be loaded at any time, in order to avoid accidents involving multiple vehicles within the site boundary. Based on the construction programme, considering that 6 trucks could be loaded over a peak 2 hour period, this is considered feasible.	To ensure that the risks from the proposed explosives storage and transport would not be unacceptable	MTRC/ Contractor	-	Construction phase		To be implemented as per construction programme
A7A	6	The design of the fill slope close to the temporary magazine site should consider potential washout failures and incorporate engineering measures to prevent a washout causing damage to the temporary magazine stores	To ensure that the risks from the proposed explosives storage would not be unacceptable	MTRC/ Contractor	-	Construction phase		To be implemented as per construction programme
A7A	6	The security plan should address different alert security level to reduce opportunity for arson / deliberate initiation of explosives. The corresponding security procedure should be implemented with respect to prevailing security alert status announced by the Government.	To ensure that the risks from the proposed explosives storage would not be unacceptable	MTRC/ Contractor	-	Construction phase		To be implemented as per construction programme

EIA Ref.	EM&A Ref.	Recommended Mitigation Measures	Objectives of the Recommended Measure & Main Concerns to address	Who to implement the measure?	Location of the measure	When to implement the measure?	What requirements or standards for the measure to achieve?	Implementation status
A7A	6	A suitable work control system should be introduced, such as an operational manual including Permit-to-Work system.	To ensure that the risks from the proposed explosives storage would not be unacceptable	MTRC/ Contractor	-	Construction phase		To be implemented as per construction programme
A7A	6	The magazine building shall be regularly checked for water seepage through the roof, walls or floor.	To ensure that the risks from the proposed explosives storage would not be unacceptable	MTRC/ Contractor	-	Construction phase		To be implemented as per construction programme
Waste Management (Construction Phase)								
8.5.1.1	7	<p>Good Site Practices</p> <p>Recommendations for good site practices during the construction activities include:</p> <ul style="list-style-type: none"> Nomination of an approved person, such as a site manager, to be responsible for good site practices, arrangements for collection and effective disposal to an appropriate facility, of all wastes generated at the site Training of site personnel in proper waste management and chemical handling procedures Provision of sufficient waste disposal points and regular collection of waste Appropriate measures to minimise windblown litter and dust/odour during transportation of waste by either covering trucks or by transporting wastes in enclosed containers Provision of wheel washing facilities before the trucks leaving the works area so as to minimise dust introduction from public road Well planned delivery programme for offsite disposal such that adverse environmental impact from transporting the C&D material is not anticipated Provision of cover for the stockpile material, sand bag or earth bund as barrier to prevent material from washing away and entering the drains 	To reduce waste generation	MTRC / Contractor	Construction Work Sites (General)	During Construction	<p>Waste Disposal Ordinance (Cap.354);</p> <p>Waste Disposal (Chemical Wastes) (General) Regulation (Cap 354) and</p> <p>ETWBTC No. 15/2003, Waste Management on Construction Site</p>	Being implemented

EIA Ref.	EM&A Ref.	Recommended Mitigation Measures	Objectives of the Recommended Measure & Main Concerns to address	Who to implement the measure?	Location of the measure	When to implement the measure?	What requirements or standards for the measure to achieve?	Implementation status
8.5.1.2	7	<p>Waste Reduction Measures Recommendations to achieve waste reduction include:</p> <ul style="list-style-type: none"> Sort C&D material from demolition and decommissioning of the existing facilities to recover recyclable portions such as metals Segregation and storage of different types of waste in different containers, skips or stockpiles to enhance reuse or recycling of materials and their proper disposal Encourage collection of aluminium cans by providing separate labelled bins to enable this waste to be segregated from other general refuse generated by the work force Proper storage and site practices to minimise the potential for damage or contamination of construction materials Plan and stock construction materials carefully to minimise amount of waste generated and avoid unnecessary generation of waste. 	For perform waste reduction	MTRC / Contractor	Construction Work Sites (General)	During Construction	<p>Waste Disposal Ordinance (Cap.354);</p> <p>Waste Disposal (Chemical Wastes) (General) Regulation; Land (Miscellaneous Provisions) Ordinance (Cap. 28)</p>	Being implemented

EIA Ref.	EM&A Ref.	Recommended Mitigation Measures	Objectives of the Recommended Measure & Main Concerns to address	Who to implement the measure?	Location of the measure	When to implement the measure?	What requirements or standards for the measure to achieve?	Implementation status
8.5.1.3	7	<p>C&D Material</p> <p>In order to minimise impacts resulting from collection and transportation of C&D material for off-site disposal, the excavated materials should be reused on-site as backfilling material as far as practicable. In addition, C&D material generated from excavation works could be reused as rock material in local projects that require public fill for reclamation and earth filling purposes, say, 'Hong Kong – Zhuhai – Macao Bridge' in association with Hong Kong Boundary Crossing Facilities and Hong Kong Link Road, Central-Wanchai Bypass and Wanchai Development Phase II project (subject to further coordination). The surplus rock and other inert C&D material should be disposed of at the Government's Public Fill Reception Facilities (PFRFs), for beneficial use by other projects in the HKSAR, or transported to Mainland China via CEDD for use by other suitable projects in the Mainland. C&D waste generated from general site clearance and tree felling works would require disposal to the designated landfill site. Other mitigation requirements are listed below:</p> <ul style="list-style-type: none"> • A Waste Management Plan should be prepared and • In order to monitor the disposal of C&D material and solid wastes at public filling facilities and landfills, and to control fly-tipping, a trip-ticket system (e.g. ETWB TCW No. 31/2004) should be included. 	To minimize impacts resulting from collection and transportation of C&D material for off-site disposal	MTRC / Contractor	Construction Work Sites (General)	During Construction	ETWB TCW No. 31/2004	Being implemented
8.5.1.4	7	<p>General Refuse</p> <p>General refuse should be stored in enclosed bins or compaction units separate from C&D material. A reputable waste collector should be employed by the contractor to remove general refuse from the site, separately from C&D material. Preferably an enclosed and covered area should be provided to reduce the occurrence of 'wind blown' light material.</p>	To minimize impacts resulting from collection and transportation of general refuse for off-site disposal	MTRC / Contractor	Construction Work Sites (General)	During Construction	Public Health and Municipal Services Ordinance (Cap. 132) - Public Cleansing and Prevention of Nuisances Regulation	Being implemented

EIA Ref.	EM&A Ref.	Recommended Mitigation Measures	Objectives of the Recommended Measure & Main Concerns to address	Who to implement the measure?	Location of the measure	When to implement the measure?	What requirements or standards for the measure to achieve?	Implementation status
8.5.1.5	7	<p>Chemical Waste</p> <p>If chemical wastes are produced at the construction site, the Contractor would be required to register with the EPD as a chemical waste producer and to follow the guidelines stated in the <i>Code of Practice on the Packaging Labelling and Storage of Chemical Wastes</i>. Good quality containers compatible with the chemical wastes should be used, and incompatible chemicals should be stored separately. Appropriate labels should be securely attached on each chemical waste container indicating the corresponding chemical characteristics of the chemical waste, such as explosive, flammable, oxidizing, irritant, toxic, harmful, corrosive, etc. The Contractor should use a licensed collector to transport and dispose of the chemical wastes, to either the approved Chemical Waste Treatment Centre, or another licensed facility, in accordance with the Waste Disposal (Chemical Waste) (General) Regulation.</p>	To minimize impacts resulting from collection and transportation of chemical waste for off-site disposal	MTRC / Contractor	Construction Work Sites (General)	During Construction	Code of Practice on the Packaging, Labelling and Storage of Chemical Wastes, Waste Disposal (Chemical Waste) (General) Regulation	Being implemented
8.5.1.6	7	<p>Marine Dredged Sediment</p> <p>The sediment at the pier site would be dredged and transferred to barges for subsequent disposal. Release of dredged sediment into the surrounding water should be avoided. It is recommended that the distance between the barge and the dredging point be shortened as far as possible to avoid dropping of sediment from the close grab to the seawater.</p>	To minimise potential impacts on water quality	MTRC/ Contractor	Dredging/ excavation area required for installation of the pier/pier structure in Aberdeen Channel	During marine construction works	ETWB TCW No. 34/2002	Being implemented
8.5.1.6	7	<p>Category H material was identified at the grab sampling location at the dredging/excavation site. As there was no exceedance of 10xLCEL for the tested parameters, the sediment to be dredged at this location should be disposed of at a confined marine disposal site. The Project Proponent should agree with MFC on the allocation of disposal site and the Contractor should apply a dumping permit from EPD prior to the dredging / excavation works.</p>	To prevent cross contamination of waste.	MTRC/ Contractor	Dredging/ excavation area with Category H material	During marine construction works	ETWB TCW No. 34/2002	To be implemented as per construction programme

EIA Ref.	EM&A Ref.	Recommended Mitigation Measures	Objectives of the Recommended Measure & Main Concerns to address	Who to implement the measure?	Location of the measure	When to implement the measure?	What requirements or standards for the measure to achieve?	Implementation status
Waste Management (Operation Phase)								
8.5.2.1	7	<p>General Refuse</p> <p>General refuse should be collected on daily basis and delivered to the refuse collection point accordingly. A reputable waste collector should be employed to remove general refuse regularly to avoid odour nuisance or pest and vermin problem. Recycling containers are recommended to be provided to encourage recycling aluminium cans and waste paper.</p>	To minimize impacts resulting from collection and transportation of general refuse for off-site disposal	MTRC	Stations and depot	During Operation	Public Health and Municipal Services Ordinance (Cap. 132) - Public Cleansing and Prevention of Nuisances Regulation	To be implemented as per construction programme
8.5.2.2	7	<p>Industrial Waste</p> <p>Similar to general refuse, a reputable waste collector should be employed to remove industrial waste regularly to avoid accumulation. Scrap materials such as metals can be recycled if uncontaminated.</p>	To minimize impacts resulting from collection and transportation of industrial waste for off-site disposal	MTRC	Stations and depot	During Operation	Public Health and Municipal Services Ordinance (Cap. 132) - Public Cleansing and Prevention of Nuisances Regulation	To be implemented as per construction programme
8.5.2.3	7	<p>Chemical Waste</p> <ul style="list-style-type: none"> Register with the EPD as a chemical waste producer should be obtained and guidelines stated in the <i>Code of Practice on the Packaging, Labelling and Storage of Chemical Wastes</i> should be followed. Good quality containers compatible with the chemical wastes should be used, and incompatible chemicals should be stored separately. Appropriate labels should be securely attached on each chemical waste container indicating the corresponding chemical characteristics of the chemical waste, such as explosive, flammable, oxidizing, irritant, toxic, harmful, corrosive, etc. Licensed collector should be deployed to transport and dispose of the chemical wastes, to either the approved Chemical Waste Treatment Centre, or another licensed facility, in accordance with the Waste Disposal (Chemical Waste) (General) Regulation. 	To minimize impacts resulting from collection and transportation of chemical waste for off-site disposal	MTRC	Stations and depot	During Operation	Waste Disposal (Chemical Waste) (General) Regulation Code of Practice on the Packaging, Labelling and Storage of Chemical Waste	To be implemented as per construction programme
Land Contamination (Construction Phase)								

EIA Ref.	EM&A Ref.	Recommended Mitigation Measures	Objectives of the Recommended Measure & Main Concerns to address	Who to implement the measure?	Location of the measure	When to implement the measure?	What requirements or standards for the measure to achieve?	Implementation status
9.7.1	8	<p>The following measures should be implemented for contaminated material excavation and transportation (if any):</p> <ul style="list-style-type: none"> • To minimize the chance for construction workers' to come into contact with contaminated materials, bulk earth-moving excavation equipment should be employed; • Contact with contaminated materials can be minimised by wearing appropriate clothing and personal protective equipment such as gloves and masks (especially when interacting directly with contaminated material), provision of washing facilities and prohibition of smoking and eating on site; • Stockpiling of contaminated excavated materials on site should be avoided as far as possible; • The use of contaminated soil for landscaping purpose should be avoided unless pre-treatment was carried out; • Vehicles containing any excavated materials should be suitably covered to reduce dust emissions and/or release of contaminated wastewater; • Truck bodies and tailgates should be sealed to stop any discharge; • Only licensed waste haulers should be used to collect and transport contaminated material to treatment/disposal site and with the implementation of tracking system to avoid fly tipping; • Speed control for trucks carrying contaminated materials should be carried out; • Observe all relevant regulations in relation to waste handling, such as Waste Disposal Ordinance (Cap 354), Waste Disposal (Chemical Waste) (General) Regulation (Cap 354) and obtain all necessary permits where required; and • Maintain records of waste generation and disposal quantities and disposal arrangements. 	To minimize as much as possible any nuisance generated in relation to land remediation activities. At the same time, to protect all personnel from possible risk associated with land remediation activities.	MTRC / Contractor	All site areas	During Construction	EIA Recommendations	Being implemented

EIA Ref.	EM&A Ref.	Recommended Mitigation Measures	Objectives of the Recommended Measure & Main Concerns to address	Who to implement the measure?	Location of the measure	When to implement the measure?	What requirements or standards for the measure to achieve?	Implementation status
Land Contamination (Operation Phase)								
9.7.2	8	Defined procedures in handling chemicals should be implemented as part of MTRCL company policy. All relevant operational procedures should be strictly followed to avoid land contamination.	To minimize as much as possible any risk in association with land contamination during operation of the Project	MTRC	All areas within the Project	During Operation	EIA Recommendations	To be implemented as per construction programme
Air Quality Impact (Construction Phase)								
10.6.2	9	Specific Dust Control Measures	To minimize adverse dust emission generated from various construction activities of the works sites	Contractor	Construction Works Sites	During Construction	EIA Recommendations	Being implemented
		<ul style="list-style-type: none"> For the unloading of spoil from trucks at barging point, installation of 3-sided screen with top and the provision of water sprays at the discharge point should be provided 						
		<ul style="list-style-type: none"> Watering every working hour for 12 hours a day on exposed soil areas on active works areas and paved haul roads to reduce dust emissions 						
		<ul style="list-style-type: none"> The rock crushing facilities with maximum daily output of over 1000m³ per day should be enclosed including unloading locations and a fabric baghouse/cartridge filter type dust extraction and collection system or equivalent system with 99% or more dust removal efficiency should be installed for the treatment of the emissions from rock crushing and screening processes. 						
10.6.2	9	Best practices for dust control are required. A control programme can be instigated to monitor the construction process in order to enforce dust controls and modify methods of works where feasible to reduce the dust emission down to acceptable levels. The following best practices for dust control should be implemented throughout the construction period: Disturbed Parts of the Roads	To minimize adverse dust emission generated from various construction activities of the works sites	Contractor	Construction Works Sites	During Construction	Air Pollution Control (Construction Dust) Regulation, EPD's Best Practicable Means and EIA Recommendations	
		<ul style="list-style-type: none"> Each and every main temporary access should be paved with concrete, bituminous hardcore materials or metal plates and kept clear of dusty materials; or 						

EIA Ref.	EM&A Ref.	Recommended Mitigation Measures	Objectives of the Recommended Measure & Main Concerns to address	Who to implement the measure?	Location of the measure	When to implement the measure?	What requirements or standards for the measure to achieve?	Implementation status
		<ul style="list-style-type: none"> Unpaved parts of the road would be sprayed with water or a dust suppression chemical so as to keep the entire road surface wet. <p>Exposed Earth</p> <ul style="list-style-type: none"> Exposed earth should be properly treated by compaction, hydroseeding, vegetation planting or seeding with latex, vinyl, bitumen within six months after the last construction activity on the site or part of the site where the exposed earth lies. <p>Loading, Unloading or Transfer of Dusty Materials</p> <ul style="list-style-type: none"> All dusty materials should be sprayed with water immediately prior to any loading or transfer operation so as to keep the dusty material wet. <p>Debris Handling</p> <ul style="list-style-type: none"> Any debris should be covered entirely by impervious sheeting or stored in a debris collection area sheltered on the top and the three sides. Before debris is dumped into a chute, water should be sprayed so that it remains wet when it is dumped. For the minor blasting at WCH Depot, tarpaulin covers would be provided on the steel screens to prevent the dust from spreading out, and the whole blasting area would be watered before and after each blast in order to help contain the dust and fumes. <p>Transport of Dusty Materials</p> <ul style="list-style-type: none"> Vehicle used for transporting dusty materials/ spoil should be covered with tarpaulin or similar material. The cover should extend over the edges of the sides and tailboards. <p>Wheel Washing</p> <ul style="list-style-type: none"> Vehicle wheel washing facilities should be provided at each construction site exit. 						

EIA Ref.	EM&A Ref.	Recommended Mitigation Measures	Objectives of the Recommended Measure & Main Concerns to address	Who to implement the measure?	Location of the measure	When to implement the measure?	What requirements or standards for the measure to achieve?	Implementation status
		<p>Stone Crushing Plant</p> <ul style="list-style-type: none"> The control measures listed in EPD's A Guidance Note on the Best Practicable Means for Mineral Works (Stone Crushing Plants) BPM 11/1) should be followed, where appropriate. <p>Concrete Batching Plant</p> <ul style="list-style-type: none"> The loading, unloading, handling, transfer or storage of dusty materials should be carried in a totally enclosed system. All dust-laden air or waste gas generated by the process operations should be properly extracted and vented to fabric filtering system. The control measures listed in EPD's A guidance note on the best practicable means for cement works (concrete batching plant) (BPM 3/2) should be followed, where appropriate. <p>Good Site Management</p> <ul style="list-style-type: none"> The Contractor should maintain high standard of housekeeping to prevent emission of fugitive dust emission. Loading, unloading, handling and storage of raw materials, wastes or by-products should be carried out in a manner so as to minimize the release of visible dust emission. Any piles of materials accumulated on or around the work areas should be cleaned up regularly. Cleaning, repair and maintenance of all plant facilities within the work areas should be carried out in a manner minimizing generation of fugitive dust emissions. The material should be handled properly to prevent fugitive dust emission before cleaning. 						

EIA Ref.	EM&A Ref.	Recommended Mitigation Measures	Objectives of the Recommended Measure & Main Concerns to address	Who to implement the measure?	Location of the measure	When to implement the measure?	What requirements or standards for the measure to achieve?	Implementation status
Cultural Heritage Impact (Construction Phase)								
11.7.1.1	10	Archaeological watching brief during the construction phase is recommended for areas highlighted as having some archaeological potential (The works sites that will require archaeological watching brief can be found in the following figures in the main report: Harcourt Garden (Figure 11.22 of EIA Report), Wong Chuk Hang San Wai (WS10) in Figure 11.35 of EIA Report and Works Sites S7, S7c, S7d and S7e (Figure 11.28 of EIA Report)	To identify and record any archaeological material or features revealed during the excavation phase of the works schedule	MTRC/ Contractor	Admiralty: Harcourt Garden Works Site; Wong Chuk Hang: Works Sites S7c,d,e, Works Site S7, Pier Columns within Works Site S10	During Construction	Antiquities and Monuments Ordinance	Implemented

APPENDIX G

Summary of Qualitative Risk Assessment Review for Rearrangement of Explosive
Delivery for Excavation of Lei Tung Station Entrance B Adit

In view of the minor adjustment in the construction sequence such that the adit of Lei Tung Entrance B (LET Ent B) would be constructed by the explosives delivered via the LET Ent B shaft instead of that from the main tunnel, the Qualitative Risk Assessment (QRA) has been reviewed based on the updated explosive delivery programme. It is also noted that there is no change to the explosive storage requirements and hence the risk associated with that.

Following the methodology as in the approved QRA report, and the maximum Individual Risk (IR) is 3.52×10^{-8} per year, which is less than the maximum IR in previous approved report (3.93×10^{-8} per year) and satisfies the Hong Kong Government Risk Criteria set out in Annex 4 of the EIAO- TM ($< 1 \times 10^{-5}$ per year). The societal risk lies within the envelope of the previously approved Worst Case scenario (Figure 1), and falls within the ALARP region of the EIAO-TM criteria.

The analyses and recommendations from the ALARP assessment with respect to explosives transport as in the approved SIL(E) EIA remain valid.

From risk assessment perspective, it can therefore be concluded that the change will not constitute a material change to the SIL(E) project in the context of EIAO.

Figure 1 F-N Curve (Societal Risk) for Storage and Transport of Explosives

