

MTR Corporation Limited

South Island Line (East)

Monthly EM&A Report No. 73

August 2017

Verified by:

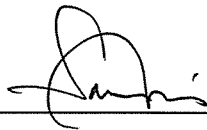

Sam Tsoi

Independent Environmental Checker

Date:

14/8/2017

MTR Corporation Limited

South Island Line (East)

Monthly EM&A Report No. 73

August 2017

Certified by:



Felice Wong

Environmental Team Leader

Date: 14 AUG 2017

MTR Corporation Limited

South Island Line (East)

Monthly EM&A Report No. 73

August 2017

Certified by: Environmental Team Leader

(please refer to submitted true copy)

Verified by: Independent Environmental Checker

(please refer to submitted true copy)

EXECUTIVE SUMMARY

With the main civil works contracts of the South Island Line (East) (SIL(E)) Project awarded in May 2011, the commencement date of construction of the Project was 25 June 2011. The Environmental Monitoring and Audit (EM&A) programme of the Project also commenced on 25 June 2011. This is the seventy third Monthly EM&A Report for SIL(E) Project. The Report presents the results of EM&A works undertaken during the period of 1 to 31 July 2017.

The operation of the SIL(E) was commenced on 28 Dec 2016. All major construction works, except works areas in Harcourt Garden, have been substantially completed on or before November 2016.

Regular site inspections will be conducted according to the requirements set out in the EM&A manual for works area for Harcourt Garden until works completion.

No complaint in relation with environmental issue was received in the reporting month.

No notification of summon or prosecution related to the environmental issue was received in the reporting period.

Regular site inspections were conducted by the Environmental Team (ET) to check the implementation of environmental mitigation measures. No non-conformance to the environmental requirements was identified in the reporting period.

Future key issues envisaged in the coming month include noise and dust emission from site works. The ET will continue the implementation of the EM&A programme in accordance to the EM&A Manual.

TABLE OF CONTENTS

EXECUTIVE SUMMARY 1

1. INTRODUCTION.....4

 1.1 Project Background4

 1.2 Project Programme4

 1.3 Coverage of EM&A Report.....4

2. PROJECT INFORMATION4

 2.1 Project Organization and Management Structure.....4

 2.2 Construction Activities in the Reporting Month4

 2.3 Construction Activities for the Coming Month.....5

 2.4 Project Areas and Environmental Monitoring Locations5

 2.5 Summary of EM&A Requirements5

3. IMPACT MONITORING5

 3.1 Air Quality.....5

 3.2 Noise6

 3.3 Water Quality6

 3.4 Action taken in Event of Exceedance.....6

4. LANDSCAPE AND VISUAL6

 4.1 EM&A Requirements.....6

 4.2 Site Audit Results6

5. ECOLOGY.....6

 5.1 EM&A Requirements.....6

 5.2 Implementation of Ecological Planting and Landscape Plan6

6. WASTE MANAGEMENT.....7

7. RECORD OF ENVIRONMENTAL COMPLAINTS7

8. RECORD OF NON-COMPLIANCES7

9. RECORD OF NOTIFICATIONS OF SUMMONS AND PROSECUTIONS7

10. STATUS OF STATUTORY SUBMISSIONS7

 10.1 Submissions required under Environmental Permit.....7

 10.2 Statutory Permits and Licenses11

11. SITE INSPECTIONS12

 11.1 Implementation of Environmental Mitigation Measures12

 11.2 Observations.....12

 11.3 Solid and Liquid Waste Management Status12

 11.4 Other Notable Events12

IEC Site Inspections.....12

12. FUTURE KEY ISSUES12

13. CONCLUSIONS.....13

List of Figures

Figures 1 to 2 *Works Areas of the Project*

Figures 3 to 6 *Location of Construction Air Quality Monitoring Stations*

Figures 7 to 8 *Location of Construction Noise Monitoring Stations*

List of Appendices

Appendix A1 *Project Organization*

Appendix A2 *Contact List of Key Personnel of the Project*

Appendix B *Implementation of Environmental Mitigation Measures*

1. INTRODUCTION

1.1 Project Background

The South Island Line (East) (SIL(E)) of 7.0km approximately is a new medium capacity railway with stations at South Horizons (SOH), Lei Tung (LET), Wong Chuk Hang (WCH), Ocean Park (OCP) and Admiralty (ADM), comprising underground and elevated structures. A depot is required at Wong Chuk Hang to provide maintenance support for the SIL(E).

1.2 Project Programme

Main civil works contracts of the SIL(E) were awarded in May 2011. The commencement date of construction of the Project was on 25 June 2011. The operation of the SIL(E) was commenced on 28 Dec 2016. The remaining construction works of Contract No. 901 was awarded to Contract No. 914 in Mid-January 2017 and is expected to complete in December 2017 tentatively.

1.3 Coverage of EM&A Report

The Environmental Monitoring and Audit (EM&A) programme of the Project commenced on 25 June 2011. This is the seventy third Monthly Environmental Monitoring and Audit (EM&A) Report for the Project. The Report presents the results of EM&A undertaken during the period of 1 to 31 July 2017.

For administrative reasons, from 1 January 2017 onwards, there will be 2 Environmental Team Leaders (ETL); one ETL will be responsible for Harcourt Garden works area and another ETL will be responsible for the EPLP monitoring from 2017 to 2018. The respective EM&A Reports will be submitted to EPD separately.

2. PROJECT INFORMATION

2.1 Project Organization and Management Structure

The project organization is shown in [Appendix A1](#). Contacts of key personnel of the Project are shown in [Appendix A2](#).

2.2 Construction Activities in the Reporting Month

The remaining construction works of 901 was awarded to Contract 914 in Mid-January 2017. Major construction activities carried out by the respective SIL(E) civil works contractors during the reporting period include:

Contract No. 914

Site	Construction Activities
Harcourt Garden	<ul style="list-style-type: none">- Hard Landscape works- Construction of LCSD office and SEE at Harcourt Garden

2.3 Construction Activities for the Coming Month

The scheduled major construction activities in the next reporting month are as follows:

Contract No. 914

Site	Construction Activities
Harcourt Garden	<ul style="list-style-type: none">- Hard Landscape works- Construction of LCSD office and SEE at Harcourt Garden

2.4 Project Areas and Environmental Monitoring Locations

The works areas of the Project are shown in **Figures 1 and 2**. All works area, except Harcourt Garden, has been substantially completed on or before November 2016. Reinstatement works for the telegraph bay barging point were completed in June 2015 and the work site was handed over to the relevant government department. The major construction works at Wong Chuk Hang Depot under Contract 908 was substantially completed in July 2015. The major construction works at Ocean Park Station & Wong Chuk Hang Station under Contract 903 were substantially completed in September 2015. The major construction works at Nam Fung Portal and Nam Fung Ventilation Building under Contract 902 were substantially completed in January 2015 and May 2016 respectively. Major construction works at Hong Kong Park Ventilation Shaft and Building under Contract 902 were substantially completed in September 2016. Major construction works at Admiralty Station and Tunnel Section from Aberdeen Channel Crossing to South Horizon, including Lei Tung Station, South Horizons Station and Plant Building as well as Lee Wing Street Ventilation Building under Contract 904 were also substantially completed in November 2016.

In view of the completion of construction works at all works area except Harcourt Garden, impact monitoring for air quality (CD1, CD2, CD3, CD4 and CD5) and noise (CN1, CN2, CN3, CN4 and CN5) and regular site inspections for such all works area were ceased. A letter of notification to EPD has been issued on 26 July 2016, 14 October 2016 and 2 December 2016. Regular site inspections for works areas in Harcourt Garden would continue until completion of construction works.

The locations of environmental monitoring stations are shown in **Figures 3 to 8**.

2.5 Summary of EM&A Requirements

The EM&A programme as specified in the EM&A Manual has been implemented during the construction stage.

In addition, regular site inspection to active works areas was carried out. The areas of inspection included the pollution control and mitigation measures within the site. Waste management and landscape and visual aspects were covered.

3. IMPACT MONITORING

3.1 Air Quality

All major construction works except works area in Harcourt Garden are completed. No air quality monitoring was carried out in the reporting month.

3.2 **Noise**

All major construction works except works area in Harcourt Garden are completed. No noise quality monitoring was carried out in the reporting month.

3.3 **Water Quality**

All marine-based works completed. No water quality monitoring was carried out in the reporting month.

3.4 **Action taken in Event of Exceedance**

Nil.

4. **LANDSCAPE AND VISUAL**

4.1 **EM&A Requirements**

The landscape and visual mitigation measures undertaken by the contractors during the construction phase have been audited on a regular basis according to the EM&A Manual.

4.2 **Site Audit Results**

Regular inspections and audits were conducted by the Certified Arborist as required by the EP and it was found that the transplanting works and the tree protection works being carried out by the civil works and transplanted contractors were in accordance with the EP/ EIA. Necessary tree removal or protection works will be carried out in accordance with the EP/ EIA or approved Tree Removal Application. No non-compliance was identified in the reporting period.

5. **ECOLOGY**

5.1 **EM&A Requirements**

All construction works near the ardeid night roost have been completed. No ecological impact monitoring was carried out in the reporting month.

5.2 **Implementation of Ecological Planting and Landscape Plan**

Planting of compensatory trees along the nullah side was substantially completed in January 2016, while planting of whip trees and shrub seedlings in the proposed woodland mix areas has been ongoing in March 2016. In compliance of condition 2.13 of the Environmental Permit and section 5.1 of the approved EPLP "The success of the compensatory planting will be monitored by the Qualified Ecologist for three years after completion of the planting works at the compensatory planting area for ardeid roosting site, which is the same in the SIL EP diagonal-stripped red Figure 7 & Figure 1&1d of the revised EPLP", it is proposed that January 2016 is the first post planting care and

maintenance covering the entire Ecological Planting and Landscape Plan area. And according to the approved Ecological Planting and Landscape Plan, the results and findings of the monitoring along the proposed habitat compensation/enhancement work areas should be reported to EPD on a quarterly basis.

In accordance with the condition 2.13 of EP and section 5.1 of approved Ecological Planting and Landscape Plan (EPLP), quarterly report on the implementation of EPLP will be submitted separately from 2017 to 2018 and the final report will be submitted in January 2019.

6. WASTE MANAGEMENT

Mitigation measures on waste management have been implemented in accordance with the site waste management plans for the respective civil works contracts. The C&D materials have been disposed of at the public fill reception facilities while C&D wastes have been disposed of at the landfills. Quantities of wastes disposed in the reporting period are summarized in the following table:

Contract No	Inert C&D Materials Disposed at Public Fill (m ³)	Inert C&D Materials Reused (m ³)	Non-inert Waste Disposed at Landfill (m ³)	Chemical Waste to Designated Treatment Facility (litre/ kg)
Reporting Period: July 2017				
Contract 914	158	0	45	0

7. RECORD OF ENVIRONMENTAL COMPLAINTS

No environmental complaint referred by EPD in the reporting period.

8. RECORD OF NON-COMPLIANCES

There was no non-compliance identified in the reporting period.

9. RECORD OF NOTIFICATIONS OF SUMMONS AND PROSECUTIONS

No summon or prosecution related to environmental issue was received or made against the Project in the reporting period.

10. STATUS OF STATUTORY SUBMISSIONS

10.1 Submissions required under Environmental Permit

A summary of the status of submissions required under the SIL(E) Environmental Permit in the reporting month is shown below:

EP Clause No.	Description of Submission	Status
1.11	Commencement date of construction	Submitted on 25 May 2011
1.14	Commencement date of operation	Submitted on 30 Sep 2016
2.1 & 2.2	Employment of IEC & ET	Submitted on 6 Apr 2011 Replacement of IEC submitted on 12 Mar 2015 and approved on 20 Mar 2015 Replacement of ET submitted on 12 Dec 2016 Replacement of ET for EPLP area submitted on 16 Jan 2017
2.3	Employment of Qualified Ecologist	Submitted on 6 Apr 2011
2.4	Employment of Certified Arborist	Updated Certified Arborist submitted on 19 Aug 2013
2.5	Management organization of main construction companies	Updated main construction companies submitted on 15 Jun 2012 Updated 914 O chart submitted on 19 Jan 2017
2.6	Construction programme & EP submission schedule	Submitted on 10 Jun 2011
2.7	Set up of Community Liaison Group	Submitted on 20 Apr 2011
2.8	Updated EM&A Manual	EP Condition fulfilled dated 13 February 2012
2.9	Construction Noise Mitigation Measures Plan	Updated Construction Noise Mitigation Measures Plan submitted on 11 May 2012 and EP Condition fulfilled date 22 May 2012
2.11	Construction & demolition materials management plan for barging points	Revised Construction & Demolition Materials Management Plan re-submitted on 7 January 2014.
2.13 (a)	Ecological planting & landscape plan	Revised plan submitted on 15 June 2014, EP Condition fulfilled dated 22 Jun 2016
2.13 (b)	As built drawings of ecological planting & landscape works	Re-submitted on 15 Jul 2016
2.13 (c)	Final monitoring report of ecological planting & landscape works	To be submitted no later than 1 month after completion of the 3-year post planting care and maintenance period
2.14 (a)	Detailed transplanting baseline survey report for plant species of conservation interest	Resubmitted on 8 Sep 2011 and no further comment received
2.14 (b)	Transplantation proposal for plant species of conservation interest	H. cordata: EP Condition fulfilled dated 15 Sep 2011 Aq. sinensis: EP Condition fulfilled dated 21 Feb 2012 Ai. fordii: EP Condition fulfilled dated 18 Oct 2011
2.14 (c)	As built drawings of transplanting works for plant species of conservation interest	H. cordata: EP Condition fulfilled dated 15 Sep 2011 Aq. sinensis: EP Condition fulfilled dated 2 May 2012 Ai. fordii: EP Condition fulfilled dated 22 Dec 2011
2.15	Tree protection plan	Updated Tree protection plan submitted on 4 May 2012 and EP

EP Clause No.	Description of Submission	Status
		Condition fulfilled dated 30 May 2012
2.16(a)	Silt curtain plan	For Aberdeen Channel: EP Condition fulfilled dated 12 Aug 2011 For Telegraph Bay: EP Condition fulfilled dated 14 Dec 2011 Water Quality Baseline Monitoring Report for Marine-based Demolition work of the temporary pier at Telegraph Bay was submitted to EPD on 26 Nov 2014 and deposited in EIAO Registered Office on 4 Dec 2014
2.17(b)	Sample test results for on-site re-use of marine sediment	EP Condition fulfilled dated 26 Apr 2013
2.17(c)	Sediment Sampling Report	EP Condition fulfilled dated 11 Jun 2014
2.25	Operational groundborne noise review plan	Resubmitted on 2 Jul 2014 and EP Condition fulfilled dated 22 Jul 2014
2.26	Operational groundborne noise mitigation measures plan	Resubmitted on 2 Jul 2014 and EP Condition fulfilled dated 22 Jul 2014
2.27	As built drawings for operational groundborne noise mitigation measures	Submitted on 18 Feb 2016 and EP Condition fulfilled dated 15 Apr 2016.
2.29	As built drawings for operational airborne noise mitigation measures on viaduct section	Submitted on 21 Jul 2016. Condition fulfilled dated 23 Dec 2016.
2.30	Noise performance test report	Operational Ground-borne Noise Performance Test Report submitted on 12 Apr 2016. Operational Air-borne Noise Performance Test Report submitted 21 Jul 2016. Condition fulfilled dated 10 Aug 2016.
2.31	Fixed plant noise audit report	Proposal of updating maximum sound power levels for fixed plant noise sources and fixed plant noise audit report submitted on 1 Nov 2016. Re-submitted on 21 Nov 2016. Condition fulfilled on 22 Nov 2016.
2.32	Visual & landscape plan	<ul style="list-style-type: none"> • Part1 - Site No.6 Nam Fung Portal: EP Condition fulfilled dated 25 Jun 2013 • Part2 - Chung Hom Shan Magazine Site: EP Condition fulfilled dated 13 Oct 2014 • Part3 - EPIW Footbridge to Ap Lei Chau Estate: EP Condition fulfilled dated 27 Feb 2015 • Part4- Wong Chuk Hang Depot: Re-submitted on 23 Dec 2016 • Part 5 – Viaduct Section from Nam

EP Clause No.	Description of Submission	Status
		<p>Fung Portal to Ocean Park Station Re-submitted on 15 Jun 2016</p> <ul style="list-style-type: none"> • Part 6 - Ap Lei Chau Cut and Cover Tunnel, Ex-Harbour Mission School and Sham Wan Towers Yellow Area: Resubmitted on 24 Jun and 22 Jul 2015; no comments confirmed on 10 Jul 2015 • Part 7- Viaduct Section from Ocean Park Station to Aberdeen Channel Re-submitted on 24 May • Part 8- Dragon Boat Area Re-submitted on 23 Jun 2016 • Part 9 – Ocean Park Station and Wong Chuk Hang Station Re-submitted on 21 Jul 2016 • Part 10 – South Horizons Station Plant Building; Submitted on 4 Sep 2015; no comments confirmed on 5 Nov 2015 • Part 11 – Nam Fung Portal site Submitted on 4 Aug 2015; no comments confirmed on 3 Mar 2016 • Part 12 – Lee Wing Street Ventilation Building and Lee Nam Road Sitting-out Areas; Submitted on 13 Aug 2015; no comments confirmed on 24 May 2016 • Part 13 – Temp. Bus Terminus at J/O Nam Long Shan Road and Police School Road; Re-submitted on 19 Jul 2016 • Part 14 – Lei Tung Station Re-submitted on 17 Jun 2016 • Part 15 – Nam Fung Building Submitted on 27 Apr 2016; no comments confirmed on 1 Aug 2016 • Part 16 – South Horizons Station Submitted on 22 Jun 2016 • Part 17 – Hong Kong Park Ventilation Building Submitted on 21 Apr 2016; no comments confirmed on 17 Oct 2016 • Part 18- New ADM station Submitted on 21 Nov 2016; no comments confirmed on 8 May 2017
3.1	Environmental Monitoring and Audit Requirements	<ul style="list-style-type: none"> • Termination of water quality monitoring at Aberdeen Channel approved on 23 Dec 2013 • Requirements of noise and air quality impact monitoring at Telegraph Bay as recommended in the C&DMMP was fulfilled on 6 Nov 2014. • Termination of noise and air quality

EP Clause No.	Description of Submission	Status
		<p>monitoring at Telegraph Bay was submitted on 29 May 2015</p> <ul style="list-style-type: none"> • Termination of water quality monitoring at Telegraph Bay was submitted on 19 Jun 2015 • Impact air quality and noise monitoring as well as regular site inspection for viaduct section from Nam Fung Portal to Aberdeen Channel Crossing with Nam Fung Ventilation Building, OCP Station, WCH Station & WCH Depot ceased since 21 Jul 2016 • EM&A programme for Hong Kong Park Ventilation Building ceased since 1 Oct 2016 • EM&A programme for Lei Tung Station and South Horizons Station and Plant Building as well as Lee Wing Street Ventilation Building ceased since 30 Nov 2016 • Impact air quality and noise monitoring as well as regular site inspection for works area at Admiralty Station and Tunnel Section from Aberdeen Channel Crossing to South Horizon, including Lei Tung Station, South Horizons Station and Plant Building as well as Lee Wing Street Ventilation Building have been ceased after November 2016.
3.3	Baseline monitoring report	EP Condition fulfilled dated 21 Feb 2012
3.4	Monthly EM&A reports	Submit within 2 weeks after the end of the reporting month
4.2	Internet address of EM&A and project data	Update of internet address submitted on 24 Dec 2014

10.2 Statutory Permits and Licenses

A summary of the status of all relevant environmental permit and licenses in the reporting month is shown below:

Description	Effective Date	Expiry Date
Environmental Permit for South Island Line (East) EP-407/2010/F	19/10/2016	N/A
Contract 914		
Chemical Waste Producer Licence	5213-124-B2507-01	27 Jan 2017
Waste Disposal	7027099	10 Mar 2017
Water Discharge Licence	WT00028235-2017	1 June 2017
Construction Noise Permit	GW-RS0214-17	13 Mar 2017
		End of Project
		End of Project
		30 June 2022
		9 Sep 2017

11. SITE INSPECTIONS

11.1 Implementation of Environmental Mitigation Measures

Regular site inspections were undertaken by the ET in accordance with the EM&A Manual to check the implementation of environmental mitigation measures in the EIA. The contractors' performance on environmental matters was assessed. The environmental mitigation measures are being implemented by the civil works contractors where appropriate. A schedule of the implementation of mitigation measures identified in the SIL(E) EIA is given in **Appendix B**.

11.2 Observations

The findings from the site inspections and the associated recommendations on improvement to the environmental protection and pollution control works were raised to the contractors for reference and/ or action. Observations against the implementation of the mitigation measures recommended in the EP/ EIA are summarized as follows:

Item	Description	Follow up Status
Contract 914		
1	The contractor was reminded to cover the stockpile soil when not in use.	Improved and standard to be maintained
2	The contractor was reminded to carry out inspection and maintenance work on trees within the work site and in the surrounding area, especially after adverse weather condition.	Improved and standard to be maintained

11.3 Solid and Liquid Waste Management Status

Base on the findings of the site inspections, the Contractors' performance in solid and liquid waste management were acceptable and compliance with the EIA requirements were demonstrated. The current management standard should be maintained.

11.4 Other Notable Events

IEC Site Inspections

The IEC site inspection was conducted on 21 July 2017 for Contract 914, contractor was reminded to cover stockpile soil when not in used. Follow up actions have been taken by 914.

12. FUTURE KEY ISSUES

Future key issues envisaged in the coming month include noise, dust and wastewater from site works, disposal of C&D wastes arising as well as tree protection on site. The ET will continue the implementation of the EM&A programme in accordance to the EM&A Manual.

13. CONCLUSIONS

It is concluded from the environmental monitoring and audit works for the SIL(E) Project that the construction works were undertaken in an appropriately environmentally sensitive manner in the reporting period. The environmental protection and pollution control measures provided by the respective civil works contractors were generally acceptable apart from some minor irregularities which were rectified timely by the contractors.

The ET will continue the implementation of the EM&A programme in accordance to the EM&A Manual and to a level consistent with MTRCL's Corporate Sustainability Policy.

APPENDIX A1
Project Organization

Appendix A1
Project Organization and Lines of Communications

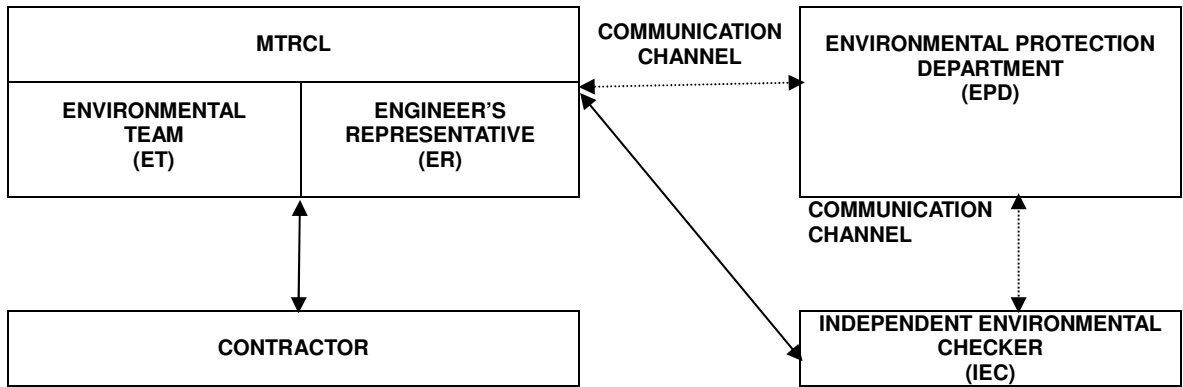

APPENDIX A2

Contact List of Key Personal of the Project

Appendix A2
Contact List of Key Personnel

Table A2.1 Contact List of Key Personnel of Project Management

Organization	Name	Telephone
Independent Environmental Checker	Mr. Sam Tsoi	2268 3208
Environmental Team Leader	Ms. Felice Wong	2688 1760
Engineer's Representative		
Project Manager – SIL	Mr. Ken Wong	(853)8506 6466
Construction Manager – SIL (914)	Mr. Mike Bezzano	3963 7282
Contract No. 914		
External Works in Harcourt Garden, Admiralty		
Main Contractor: Build King Construction Limited		
Project Director	Mr. Hon Yee	9090 3109
QA & Environmental Manager	Mr. Ronald Fung	9777 7667

Table A2.2 Contact List of Key Personnel of EPD

Organization	Name	Telephone
EPD		
Sr Env Protection Offr (Metro Assessment)	Mr. Richard Wong	2835 1128
Sr Env Protection Offr (Regional S)	Dr. Anthony Lee	2516 1802
Sr Env Protection Offr (Regional S)	Mr. Sean Law	2516 1806

APPENDIX B

Implementation of Environmental Mitigation Measures

EIA Ref.	EM&A Ref.	Recommended Mitigation Measures	Objectives of the Recommended Measure & Main Concerns to address	Who to implement the measure?	Location of the measure	When to implement the measure?	What requirements or standards for the measure to achieve?	Implementation status
Noise Impact (Construction Phase)								
<i>Airborne</i>								
3.4.1.4	2	Adoption of Quieter PME The recommended quieter PME adopted in the assessment were taken from the BS5228: Part 1:2009 and are presented in Table 3.20 . It should be noted that the silenced PME selected for assessment can be found in Hong Kong.	To minimize the construction air-borne noise impact	Contractors	Construction Work Sites	During Construction	EIAO and NCO	Implemented
3.4.1.4	2	Use of Movable Noise Barrier The use of movable barrier for certain PME can further alleviate the construction noise impacts. In general, a 5 dB(A) reduction for movable PME and 10 dB(A) for stationary PME can be achieved depending on the actual design of the movable noise barrier. The Contractor shall be responsible for design of the movable noise barrier with due consideration given to the size of the PME and the requirement for intercepting the line of sight between the NSRs and PME. Barrier material with surface mass in excess of 7 kg/m ² is recommended to achieve the predicted screening effect.	To minimize the construction air-borne noise impact	Contractors	Construction Work Sites	During Construction	EIAO and NCO	Implemented
3.4.1.4	2	Use of Noise Enclosure/ Acoustic Shed The use of noise enclosure or acoustic shed is to cover stationary PME such as air compressor and concrete pump. With the adoption of the noise enclosure, the PME could be completely screened, and noise reduction of 15 dB(A) can be achieved according to the GW-TM.	To minimize the construction air-borne noise impact	Contractors	Construction Work Sites	During Construction	EIAO and NCO	Implemented
3.4.1.4	2	Use of Silencer To reduce noise emission from the ventilation fans, silencers are also recommended to be used in fan ventilation system to attenuate noise generated during fan operation to achieve a noise reduction of 15 dB(A).	To minimize the construction air-borne noise impact	Contractors	Construction Work Sites	During Construction	EIAO and NCO	Implemented

EIA Ref.	EM&A Ref.	Recommended Mitigation Measures	Objectives of the Recommended Measure & Main Concerns to address	Who to implement the measure?	Location of the measure	When to implement the measure?	What requirements or standards for the measure to achieve?	Implementation status
3.4.1.4	2	Use of Noise Insulating Fabric Noise insulating fabric (the Fabric) can also be adopted for certain PME (e.g. drill rig, piling auger etc). The Fabric should be lapped such that there are no openings or gaps on the joints. Technical data from manufacturers state that by using the Fabric, a noise reduction of over 10 dB(A) can be achieved on noise level.	To minimize the construction air-borne noise impact	Contractors	Construction Work Sites	During Construction	EIAO and NCO	Implemented
3.4.1.4	2	Good Site Practice The good site practices listed below should be followed during each phase of construction: <ul style="list-style-type: none"> • Only well-maintained plant should be operated on-site and plant should be serviced regularly during the construction programme; • Silencers or mufflers on construction equipment should be utilized and properly maintained during the construction programme; • Mobile plant, if any, should be sited as far from NSRs as possible; • Machines and plant (such as trucks) that may be in intermittent use should be shut down between work periods or should be throttled down to a minimum; • Plant known to emit noise strongly in one direction should, wherever possible, be orientated so that the noise is directed away from the nearby NSRs; and • Material stockpiles and other structures should be effectively utilized, wherever practicable, in screening noise from on-site construction activities. 	To minimize the construction air-borne noise impact	Contractors	Construction Work Sites	During Construction	EIAO and NCO	Implemented
<i>Ground-borne</i>								
3.4.2.5	2	PME that is in intermittent use should be shut down between work periods or should be throttled down to a minimum.	To minimize the construction ground-borne noise impact	Contractors	Tunnel site near Lei Tung Station	During Construction	NCO	Implemented
Noise Impact (Operation Phase)								
<i>Airborne</i>								

EIA Ref.	EM&A Ref.	Recommended Mitigation Measures	Objectives of the Recommended Measure & Main Concerns to address	Who to implement the measure?	Location of the measure	When to implement the measure?	What requirements or standards for the measure to achieve?	Implementation status
<u>Railway Noise</u>								
3.5.1.1	2	Erection of noise barrier/ enclosure along the viaduct section as shown in Table 3.52 and illustrated in Figures 3.25 to 3.27 . For the 'Further Mitigation Measures for Existing and Planned NSRs', additional noise barriers/semi-enclosures have been recommended for viaduct sections shown in Table 3.57 and illustrated in Figure 3.28 to 3.30 . The viaduct structure should allow further installation of noise barrier or enclosure at the later commissioning stage, if required.	To minimize the railway airborne noise along the viaduct section of SIL(E)	MTRC / Contractor	West of ex-Canadian Hospital site, West of Ocean Park G/IC site, East and West of Wong Chuk Hang Residential Zone, along Wong Chuk Hang Nullah and along Ap Lei Chau Bridge as shown in Figure 3.25 to Figure 3.30.	Before Operation	EIAO and NCO	Implemented
<u>Fixed Plant Noise</u>								
3.5.1.2	2	The following noise reduction measures shall be considered as far as practicable during construction: <ul style="list-style-type: none"> Choose quieter plant such as those which have been effectively silenced; Include noise levels specification when ordering new plant (including chillier and E/M equipment); Locate fixed plant/louver away from any NSRs as far as practicable; Locate fixed plant in walled plant rooms or in specially designed enclosures; Locate noisy machines in a basement or a completely separate building; Install direct noise mitigation measures including silencers, acoustic louvers and acoustic enclosure where necessary; and Develop and implement a regularly scheduled plant maintenance programme so that equipment is properly operated and serviced in order to maintain a controlled level of noise. 	To minimize the fixed plant noise impact	MTRC	All stations, entrances, and ventilation buildings	Before Operation	EIAO and NCO	Implemented
<i>Ground-borne</i>								

EIA Ref.	EM&A Ref.	Recommended Mitigation Measures	Objectives of the Recommended Measure & Main Concerns to address	Who to implement the measure?	Location of the measure	When to implement the measure?	What requirements or standards for the measure to achieve?	Implementation status
3.5.2.3	2	Using of incline turnout (a 5 dB(A) reduction in turnout and crossing vibration) and Type 1a resilient baseplated trackform within the SOH station.	To minimize the railway ground-borne noise impact	MTRC / Contractor	South Horizons Station	Before Operation	EIAO and NCO	Implemented
Ecological Impact (Construction Phase)								
<i>Habitat Loss</i>								
4.7.1	3	Minimise habitat loss particularly woodland as far as possible.	Minimize habitat loss	Contractors	Construction Work Sites	During Construction	Annex 16 of EIAO-TM	Implemented
4.7.1	3	Temporary disturbed woodland should be reinstated in full after the completion of works	To reinstate disturbed woodland habitats	Contractors	Construction Work Sites	After completion of construction works	Annex 16 of EIAO-TM; ETWB TCW No. 2/2004 (for maintenance arrangement of vegetation)	Implemented
4.7.1	3	Degraded woodland and shrubland should be reinstated after the completion of works as far as possible.	To reinstate disturbed habitats	Contractors	Construction Work Sites	After completion of construction works	Annex 16 of EIAO-TM; ETWB TCW No. 2/2004 (for maintenance arrangement of vegetation)	Implemented
4.7.1	3	Habitat Compensation of permanent loss of woodland in full in terms of area.	To compensate permanent loss of woodland	Contractors	Construction Work Sites	After completion of construction works	Annex 16 of EIAO-TM; ETWB TCW No. 2/2004 (for maintenance arrangement of vegetation)	Implemented
<i>Ardeid Night Roost</i>								
4.7.2.1	3	Avoidance of Site Clearance and Tree Felling Works at Wintering Season Site clearance and tree felling works at the existing ardeid night roost (location described in Figure 4.15) should only be carried out at non-wintering season (March to November inclusive). Demarcating clearly the works area and ensuring good site practise to avoid unnecessary disturbance to the ardeids during construction phase.	Avoid and minimize impact on peak period of ardeid roosting	Contractor	Construction Work Sites	During Construction	Annex 16 of EIAO-TM	Implemented

EIA Ref.	EM&A Ref.	Recommended Mitigation Measures	Objectives of the Recommended Measure & Main Concerns to address	Who to implement the measure?	Location of the measure	When to implement the measure?	What requirements or standards for the measure to achieve?	Implementation status
4.7.2.1 and 4.7.2.4	3	<p>Compensate for loss of roosting trees with replanting of suitable trees</p> <p>The compensatory planting with suitable, heavy standard trees should be located at the lower course of the WCH Nullah approximately 200m west of the existing night roost (location shown in Figure 4.15). Trees should be replanted after construction alongside the nullah to provide a substrate for roosting.</p>	To compensate for permanent loss of roosting trees	Contractors, advised by Ecologist	Construction Work Site at Wong Chuk Hang	After completion of construction works	Annex 16 of EIAO-TM; ETWB TCW No. 2/2004 (for maintenance arrangement of vegetation)	Implemented
4.7.2.1	3	<p>Inspection of ardeid night roost for active ardeid nests</p> <p>When conducting site clearance works at the existing ardeid night roost, the area should be inspected to confirm no active ardeid nest are present. If any active bird nest is observed, suitably sized buffer area should be established to minimize human or machinery disturbance until the nest is abandoned. Also the site should be monitored monthly to check the updated status.</p>	Ensure no impact on active ardeid nests	Contractors, advised by Ecologist	Construction Work Site at Wong Chuk Hang	During Construction	Wild Animals Protection Ordinance (Cap. 170)	Implemented
4.7.2.2	3	<p>Avoidance of Construction Activities at Sunset Time</p> <p>Construction activities using PME at the potential ardeid night roost (location shown in Figure 4.13) should be ceased at 18:00 – 06:00 to avoid disturbance to the night roost ardeids.</p>	Minimize noise impact on ardeid roosting and foraging	Contractor	Construction Work Sites	During Construction	Annex 16 of EIAO-TM	Implemented
4.7.2.4	3	<p>Coloured Panels on Noise Barriers</p> <p>The acoustic enclosure/ barrier should be designed with coloured panels to minimize the chance of bird collision.</p>	To minimise the potential for bird strike	Contractors	Construction Work Sites	During Construction	Annex 16 of EIAO-TM;	Implemented
4.7.3	3	<p>Magazine Site</p> <p>Implement good site practice including containment of silt runoff within the site boundary, containment of contaminated soils, appropriate storage of chemicals and wastes.</p>	Avoid impacts to fauna species and water pollution	Contractor	Chung Hom Shan Magazine Site	During Construction	ProPECC Note PN 1/94 Waste Disposal Ordinance (Cap.354)	Implemented

EIA Ref.	EM&A Ref.	Recommended Mitigation Measures	Objectives of the Recommended Measure & Main Concerns to address	Who to implement the measure?	Location of the measure	When to implement the measure?	What requirements or standards for the measure to achieve?	Implementation status
4.7.4	3	Coral Community at Aberdeen Channel A bridge pier construction method in which a cofferdam would be installed to create a confined dredging environment should be implemented to minimise potential impacts from suspended solid release. Good site practices should be applied to land-based construction works including containment of silt runoff within the site boundary, the containment of contaminated soils for removal from the site and appropriate storage of chemicals and chemical waste.	Avoid release of suspended solid and contaminated runoff to Aberdeen Channel	Contractors	Dredging/ excavation area required for installation of the pier/pier foundations of bridge in Aberdeen Channel	During marine construction works	WQOs & ProPECC Note PN 1/94	Implemented
4.7.5	3	Floral Species of Conservation Interest Transplanting all affected floral species of conservation interest identified in the EcolA. <i>In-situ</i> preservation should be re-considered throughout all stages of the project.	Mitigate the removal impact on floral species of conservation interest	Contractors	Construction Work Sites	During Construction	Annex 16 of EIAO-TM;	Implemented
Water Quality Impact (Construction)								
5.7.1.1	4	Dredging/ Excavation and Seawall modification for construction of piers/pier foundations of bridge in Aberdeen Channel To minimise the loss of fine sediment to suspension, steel pile casing and watertight cofferdam should be installed and seawater trapped inside the casing and cofferdam should be pumped out to generate a dry working environment prior to carrying out sediment dredging/ excavation. The water from the dewatering should be appropriately treated with desilting or sedimentation device before discharge. Silt curtains should be deployed to completely enclose the cofferdam installation and removal works and the seawall modification and pile installation works respectively.	Avoid spillage of sediment	MTRC / Contractor	Dredging/ excavation area required for installation of the pier/pier foundations of bridge in Aberdeen Channel	During marine construction works	WQOs & ProPECC Note PN 1/94	Implemented

EIA Ref.	EM&A Ref.	Recommended Mitigation Measures	Objectives of the Recommended Measure & Main Concerns to address	Who to implement the measure?	Location of the measure	When to implement the measure?	What requirements or standards for the measure to achieve?	Implementation status
5.7.1.2	4	<p>Barging Facilities and Activities</p> <p>To minimise the release of suspended solids to marine waters, silt curtain should be deployed to completely enclose the marine piles works during installation and decommissioning. Good site practices for operation of barging points should be followed, including appropriate sizing of vessels to ensure adequate clearance between the vessel and the seabed, controlled loading and unloading of barges and hoppers to prevent splash, installing tight fitting seals to the bottom openings to prevent leakage, and measures to prevent foam, oil, grease, scum or litter on the water within the site.</p>	To minimize suspended solids and water quality impacts	MTRC / Contractor	Barging point marine works area	During marine construction works	WQOs & ProPECC Note PN 1/94	Implemented
5.7.1.3	4	<p>Sewage Effluent from Construction Workforce</p> <p>Temporary sanitary facilities, such as portable chemical toilets, should be employed on-site where necessary to handle sewage from the workforce. A licensed contractor should be employed to provide appropriate and adequate portable toilets and be responsible for appropriate disposal and maintenance.</p>	To minimize water quality impacts	MTRC / Contractor	All works areas with on-site sanitary facilities	During Construction	Water Pollution Control Ordinance	Implemented
5.7.1.4	4	<p>Wastewater Discharge from Tunnelling and Open Cut Excavation</p> <p>Wastewater with a high level of suspended solids should be treated before discharge by settlement in tanks with sufficient retention time. Oil interceptors would be required to remove the oil, lubricants and grease from wastewater. Should the level of suspended solids be very high, an on-site pre-packaged treatment plant might be required with the addition of flocculants to improve the settlement of solids. A discharge licence under the WPCO would be required for discharge to stormwater drain.</p>	To minimize water quality impacts	MTRC / Contractor	All works areas	During Construction	Water Pollution Control Ordinance	Implemented
5.7.1.5	4	<p>Construction Site Runoff and Drainage</p> <p>The site practices outlined in ProPECC Note PN 1/94 should be followed as far as practicable in order to minimise surface runoff and the chance of erosion. The following measures are recommended to protect water quality and sensitive uses of the coastal area i.e. WSD seawater intakes along the Aberdeen Channel:</p>	To minimize water quality impacts	MTRC / Contractor	All works areas	During Construction	ProPECC Note PN 1/94	Implemented

EIA Ref.	EM&A Ref.	Recommended Mitigation Measures	Objectives of the Recommended Measure & Main Concerns to address	Who to implement the measure?	Location of the measure	When to implement the measure?	What requirements or standards for the measure to achieve?	Implementation status
		<ul style="list-style-type: none"> • At the start of site establishment (including the barging facilities), perimeter cut-off drains to direct off-site water around the site should be constructed with internal drainage works and erosion and sedimentation control facilities implemented. Channels (both temporary and permanent drainage pipes and culverts), earth bunds or sand bag barriers should be provided on site to direct stormwater to silt removal facilities. The design of the temporary on-site drainage system should be undertaken by the Contractor prior to the commencement of construction. • The dikes or embankments for flood protection should be implemented around the boundaries of earthwork areas. Temporary ditches should be provided to facilitate the runoff discharge into stormwater drainage system through a sediment/silt trap. The sediment/silt traps should be incorporated in the permanent drainage channels to enhance deposition rates, if practical. • Sand/silt removal facilities such as sand/silt traps and sediment basins should be provided to remove sand/silt particles from runoff to meet the requirements of the TM standards under the WPCO. The design of efficient silt removal facilities should be based on the guidelines in Appendix A1 of ProPECC Note PN 1/94. Sizes may vary depending upon the flow rate. The detailed design of the sand/silt traps should be undertaken by the Contractor prior to the commencement of construction. 						

EIA Ref.	EM&A Ref.	Recommended Mitigation Measures	Objectives of the Recommended Measure & Main Concerns to address	Who to implement the measure?	Location of the measure	When to implement the measure?	What requirements or standards for the measure to achieve?	Implementation status
		<ul style="list-style-type: none"> • All drainage facilities and erosion and sediment control structures should be regularly inspected and maintained to ensure proper and efficient operation at all times and particularly during rainstorms. Deposited silt and grit should be regularly removed, at the onset of and after each rainstorm to ensure that these facilities are functioning properly at all times. • Measures should be taken to minimize the ingress of site drainage into excavations. If excavation of trenches in wet periods is necessary, they should be dug and backfilled in short sections wherever practicable. Water pumped out from foundation excavations should be discharged into storm drains via silt removal facilities. • If surface excavation works cannot be avoided during the wet season (April to September), temporarily exposed slope/soil surfaces should be covered by tarpaulin or other means, as far as practicable, and temporary access roads should be protected by crushed stone or gravel, as excavation proceeds. Interception channels should be provided (e.g. along the crest/edge of the excavation) to prevent storm runoff from washing across exposed soil surfaces. • The overall slope of the site should be kept to a minimum to reduce the erosive potential of surface water flows. 						

EIA Ref.	EM&A Ref.	Recommended Mitigation Measures	Objectives of the Recommended Measure & Main Concerns to address	Who to implement the measure?	Location of the measure	When to implement the measure?	What requirements or standards for the measure to achieve?	Implementation status
		<ul style="list-style-type: none"> • All vehicles and plant should be cleaned before leaving a construction site to ensure no earth, mud, debris and the like is deposited by them on roads. An adequately designed and sited wheel washing facility should be provided at construction site exit where practicable. Wash-water should have sand and silt settled out and removed regularly to ensure the continued efficiency of the process. The section of access road leading to, and exiting from, the wheel-wash bay to the public road should be paved with sufficient backfall toward the wheel-wash bay to prevent vehicle tracking of soil and silty water to public roads and drains. • Open stockpiles of construction materials or construction wastes on-site should be covered with tarpaulin or similar fabric during rainstorms. Measures should be taken to prevent the washing away of construction materials, soil, silt or debris into any drainage system. • Manholes (including newly constructed ones) should be adequately covered and temporarily sealed so as to prevent silt, construction materials or debris being washed into the drainage system and stormwater runoff being directed into foul sewers. • Precautions should be taken at any time of the year when rainstorms are likely. Actions should be taken when a rainstorm is imminent or forecasted and actions to be taken during or after rainstorms are summarized in Appendix A2 of ProPECC Note PN 1/94. Particular attention should be paid to the control of silty surface runoff during storm events, especially for areas located near steep slopes. 						

EIA Ref.	EM&A Ref.	Recommended Mitigation Measures	Objectives of the Recommended Measure & Main Concerns to address	Who to implement the measure?	Location of the measure	When to implement the measure?	What requirements or standards for the measure to achieve?	Implementation status
		<ul style="list-style-type: none"> Bentonite slurries used in piling or slurry walling should be reconditioned and reused wherever practicable. Temporary enclosed storage locations should be provided on-site for any unused bentonite that needs to be transported away after all the related construction activities are completed. The requirements in ProPECC Note PN 1/94 should be adhered to in the handling and disposal of bentonite slurries. 						
5.7.1.6	4	<p>General Construction Activities</p> <p>Construction solid waste, debris and refuse generated on-site should be collected, handled and disposed of properly to avoid entering any nearby stormwater drain. Stockpiles of cement and other construction materials should be kept covered when not being used.</p> <p>Oils and fuels should only be stored in designated areas which have pollution prevention facilities. To prevent spillage of fuels and solvents to any nearby stormwater drain, all fuel tanks and storage areas should be provided with locks and be sited on sealed areas, within bunds of a capacity equal to 110% of the storage capacity of the largest tank. The bund should be drained of rainwater after a rain event.</p>	To minimize water quality impacts	MTRC / Contractor	All works areas	During Construction	EIA Recommendation	Implemented
Water Quality Impact (Operation)								
5.7.2.1	4	<p>Change in flow regime and hydrology in Aberdeen Channel (Typhoon Shelter) (ATS) due to railway bridge</p> <p>Streamline shaped bridge pier to reduce friction to the tidal flows across the Aberdeen Channel should been considered in the conceptual design of the bridge form.</p>	To minimize water quality impacts	MTRC / Detailed Design Consultant	Pier/pier foundations of bridge in Aberdeen Channel	During Detailed Design	EIA Recommendation	Implemented

EIA Ref.	EM&A Ref.	Recommended Mitigation Measures	Objectives of the Recommended Measure & Main Concerns to address	Who to implement the measure?	Location of the measure	When to implement the measure?	What requirements or standards for the measure to achieve?	Implementation status
5.7.2.3	4	<p>Sewage and wastewater effluents from stations and depot</p> <ul style="list-style-type: none"> Runoff and spillage prevention measures should conform to relevant engineering and design standards. Any opportunities for the recycling of water within the automatic washing facilities should be sought to minimise discharge requirements. Bio-degradable detergents should be selected to minimise the impact on water quality and associated ecosystems of the receiving water bodies. Plant maintenance areas should be bunded and constructed on an impermeable floor, and provided with petrol interceptors. Traps and interceptors should be regularly cleaned and maintained, especially after any accidental spillages. Layers of sawdust, sand or equivalent material should be laid underneath and around any plant and equipment that may possibly leak oil. An emergency spillage action plan should be developed for the Depot to ensure that any accidental spillage event is treated immediately and does not impact on any water bodies. All fuel tanks and storage areas within the Depot should be provided with locks and be located on sealed areas, within bunds of a capacity equal to 110% of the storage capacity of the largest tank, to prevent the escape of spilled fuel oils. Waste oil and other chemicals must be disposed by a licensed contractor to either the approved Chemical Waste Treatment Centre, or another licensed facility, in accordance with the Waste Disposal (Chemical Waste) (General) Regulation (Cap 354). 	To minimize water quality impacts	MTRC	SIL(E) Stations & WCH Depot	During Operation	WPCO	Implemented

EIA Ref.	EM&A Ref.	Recommended Mitigation Measures	Objectives of the Recommended Measure & Main Concerns to address	Who to implement the measure?	Location of the measure	When to implement the measure?	What requirements or standards for the measure to achieve?	Implementation status
5.7.2.4	4	<p>Runoff from rail tracks</p> <ul style="list-style-type: none"> Track drainage channels discharge should pass through oil/grit interceptors/chambers to remove oil, grease and sediment before being pumped to the public stormwater drainage system. Silt traps and oil interceptors should be cleaned and maintained regularly. Oily contents of the oil interceptors should be transferred to an appropriate disposal facility, or to be collected for reuse, if possible. 	To minimize water quality impacts	MTRC	Along the SIL(E) tracks	During Operation	WPCO	Implemented
Landscape and Visual Impact (Construction Phase)								
Table 6-13	Preservation of Existing Vegetation							
CP1.1	5	To retain trees, which have high amenity or ecology value and contribute most to the landscape and visual amenity of the site and its immediate environs.	To minimise the disturbance to the existing landscape resources.	Project Landscape Architect (Detailed Design Consultants)/ Contractor	Site	Throughout design phase	TM-EIA Annex 18, ETWB TCW No. 3/2006 & 2/2004	Implemented
CP1.2	5	Creation of precautionary area around trees to be retained equal to half of the trees canopy diameter. Precautionary area to be fenced.	To ensure the success of the tree preservation proposals.	Contractor	Site	Before construction phase commence	TM-EIA Annex 18, ETWB TCW No. 3/2006 & 2/2004	Implemented
CP1.3	5	Prohibition of the storage of materials including fuel, the movement of construction vehicles, and the refuelling and washing of equipment including concrete mixers within the precautionary area.	To ensure the success of the tree preservation proposals.	Contractor	Site	Throughout construction phase	TM-EIA Annex 18, ETWB TCW No. 3/2006 & 2/2004	Implemented
CP1.4	5	Phased segmental root pruning for trees to be retained and transplanted over a suitable period (determined by species and size) prior to lifting or site formation works which affect the existing rootball of trees identified for retention. The extent of the pruning will be based on the size and the species of the tree in each case.	To ensure the success of the tree preservation proposals.	Contractor	Site	Throughout construction phase	TM-EIA Annex 18, ETWB TCW No. 3/2006 & 2/2004	Implemented
CP1.5	5	Pruning of the branches of existing trees identified for transplantation and retention to be based on the principle of crown thinning maintaining their form and amenity value.	To ensure the success of the tree preservation proposals.	Contractor	Site	Throughout construction phase	TM-EIA Annex 18, ETWB TCW No. 3/2006 & 2/2004	Implemented

Appendix B Implementation of Environmental Mitigation Measures (Status as of 31 July 2017)

EIA Ref.	EM&A Ref.	Recommended Mitigation Measures	Objectives of the Recommended Measure & Main Concerns to address	Who to implement the measure?	Location of the measure	When to implement the measure?	What requirements or standards for the measure to achieve?	Implementation status
CP1.6	5	The watering of existing vegetation particularly during periods of excavation when the water table beneath the existing vegetation is lowered.	To ensure the success of the tree preservation proposals.	Contractor	Site	Throughout construction phase	TM-EIA Annex 18, ETWB TCW No. 3/2006 & 2/2004	Implemented
CP1.7	5	The rectification and repair of damaged vegetation following the construction phase to it's original condition prior to the commencement of the works or replacement using specimens of the same species, size and form where appropriate to the design intention of the area affected	To ensure the success of the tree preservation proposals.	Contractor	Site	Throughout construction phase	TM-EIA Annex 18, ETWB TCW No. 3/2006 & 2/2004	To be implemented as per construction programme
CP1.8	5	All works affecting the trees identified for retention and transplanted will be carefully monitored. This includes the key stages in the preparation of the trees, the implementation of protection measures and health monitoring through out the construction period	To ensure the success of the tree preservation proposals.	Contractor	Site	Throughout construction phase	TM-EIA Annex 18, ETWB TCW No. 3/2006 & 2/2004	Being implemented
CP1.9	5	Detailed landscape and tree preservation proposals will be submitted to the relevant government departments for approval under the lease conditions and in accordance with ETWB TCW No. 2/2004 and 3/2006.	To ensure the tree preservation and planting proposals are integrated with the existing landscape context and that the landscape resources are preserved where appropriate.	Project Landscape Architect (Detailed Design Consultants)	Site	Throughout design phase	TM-EIA Annex 18, ETWB TCW No. 3/2006 & 2/2004	Implemented
CP1.10	5	The tree preservation works should be implemented. A tree protection specification would be included within the contract documents.	To ensure the tree preservation and planting proposals are integrated with the existing landscape context and that the landscape resources are preserved where appropriate.	Project Proponent	Site	Throughout design and construction phases	TM-EIA Annex 18, ETWB TCW No. 3/2006 & 2/2004	Implemented
Table 6-13	Works Area and Temporary Works Areas							
CP2.1	5	Where appropriate to the final design the landscape of these works areas should be restored following the completion of the construction phase.	To minimise the disturbance to existing landscape resources and change of visual amenity.	Contractor	Site	Through out construction phase	TM-EIA Annex 18	Implemented

EIA Ref.	EM&A Ref.	Recommended Mitigation Measures	Objectives of the Recommended Measure & Main Concerns to address	Who to implement the measure?	Location of the measure	When to implement the measure?	What requirements or standards for the measure to achieve?	Implementation status
CP2.2	5	Construction site controls should be enforced including the storage of materials, the location and appearance of site accommodation and the careful design of site lighting to prevent light spillage.	To minimise the disturbance to existing landscape resources and change of visual amenity.	Contractor	Site	Through out construction phase	TM-EIA Annex 18	Implemented
CP2.3	5	Screen the works area during the construction phase through the use of decorative hoarding along the site boundary facing adjacent VSRs	To minimise the disturbance to existing landscape resources and change of visual amenity.	Contractor	Site	Through out construction phase	TM-EIA Annex 18	Implemented
Table 6-13	Implementation of Mitigation Planting and planting species selection							
CP3.1	5	Replanting of disturbed vegetation should be undertaken at the earliest possible stage of the construction phase.	To minimise the disturbance to existing landscape resources and minimize the impacts on the visual amenity of the area.	Contractor	Site	After the site formation and on completion of planting area.	TM-EIA Annex 18, ETWB TCW No. 3/2006 & 2/2004	Implemented
CP3.2	5	Use of native plant species predominantly in the planting design for the buffer areas.	To enhance the local landscape and ecological value.	Project Landscape Architect (Detailed Design Consultants)	Site	After the site formation and on completion of planting area.	TM-EIA Annex 18, ETWB TCW No. 3/2006 & 2/2004	Implemented
CP3.3	5	Proposed mitigation planting shall not only limit to conventional amenity planting, but also considered alternative greening measures such as vertical greening for screening or soften the built structures. Small shrubs, climbing plants, grass and groundcovers shall be used in specific locations according to site condition and at where would not interfere the operation of railway and its associated facilities.	To maximise the planting opportunities	Project Landscape Architect (Detailed Design Consultants)	Site	Throughout design and construction phases	TM-EIA Annex 18, ETWB TCW No. 3/2006 & 2/2004	Being implemented
CP3.4	5	The tree planting works should be implemented by approved Landscape Contractors and inspected and approved on site by a qualified Landscape Architect. A tree planting specification would be included within the contract documents.	To ensure the tree preservation and planting proposals are integrated with the existing landscape context and that valuable landscape	Project Proponent	Site	Throughout design and construction phases	TM-EIA Annex 18, ETWB TCW No. 3/2006 & 2/2004	Being implemented

EIA Ref.	EM&A Ref.	Recommended Mitigation Measures	Objectives of the Recommended Measure & Main Concerns to address	Who to implement the measure?	Location of the measure	When to implement the measure?	What requirements or standards for the measure to achieve?	Implementation status
Table 6-13		Transplantation of Existing Trees						
CP4.1	5	The tree transplanting works should be implemented by approved Landscape Contractors and inspected and approved on site by a qualified Landscape Architect. A tree protection / transplanting specification would be included within the contract documents.	To ensure the tree preservation and planting proposals are integrated with the existing landscape context and that valuable landscape resources are preserved where appropriate to the final design.	Project Proponent / Contractor	Site	Throughout design and construction phases	TM-EIA Annex 18, ETWB TCW No. 3/2006 & 2/2004	Implemented
CP4.2	5	Approximately 437 existing trees to be transplanted, majority of them shall be relocated to off-site planting areas. The final recipient sites should be, as far as space allows, adjacent to their current locations alongside of the alignment.	To retain their contribution to the local landscape context.	Project Landscape Architect (Detailed Design Consultants)/ Contractor / Project Proponent (planting areas associated with station and alignment)/ LCSD (roadside and park areas)	Site	Throughout design and construction phases	TM-EIA Annex 18, ETWB TCW No. 3/2006 & 2/2004	Implemented
CP4.3	5	Tree to be transplanted to planting areas identified in the "Southern District Greening Master Plan" shall be, as far as programme allows, directly relocated to their final recipient sites.	To minimise the disturbance to the landscape resources.	Project Landscape Architect (Detailed Design Consultants)/ Contractor / Project Proponent (planting areas associated with station and alignment)/ LCSD (roadside and park areas)	Site	Throughout design and construction phases	TM-EIA Annex 18, ETWB TCW No. 3/2006 & 2/2004	Implemented
CP4.4	5	Tree to be replanted along the alignment shall be kept in the temporary holding nurseries which closely monitoring by landscape contractor.	To enhance the survivals of the transplanted trees	Project Landscape Architect (Detailed Design Consultants)/ Contractor	Site	Throughout design and construction phases	TM-EIA Annex 18, ETWB TCW No. 3/2006 & 2/2004	Implemented

EIA Ref.	EM&A Ref.	Recommended Mitigation Measures	Objectives of the Recommended Measure & Main Concerns to address	Who to implement the measure?	Location of the measure	When to implement the measure?	What requirements or standards for the measure to achieve?	Implementation status
CP4.5	5	The implementation programme for the proposed works should reserve enough time for the advance tree transplanting preparation works.	To enhance the survivals of the transplanted trees	Project Proponent/ Project Landscape Architect (Detailed Design Consultants)/ Contractor	Site	Throughout design and construction phases	TM-EIA Annex 18, ETWB TCW No. 3/2006 & 2/2004	Implemented
CP4.6	5	The implementation programme for the proposed works should reserve enough time for the advance tree transplanting preparation works.	To enhance the survivals of the transplanted trees	Project Proponent/ Project Landscape Architect (Detailed Design Consultants)/ Contractor	Site	Throughout design and construction phases	TM-EIA Annex 18, ETWB TCW No. 3/2006 & 2/2004	Implemented
CP4.7	5	The tree transplanting works should be implemented by approved Landscape Contractors and inspected and approved on site by a qualified Landscape Architect. A tree protection specification would be included within the contract documents.	To enhance the survivals of the transplanted trees	Project Proponent/ Project Landscape Architect (Detailed Design Consultants)/ Contractor	Site	Throughout design and construction phases	TM-EIA Annex 18, ETWB TCW No. 3/2006 & 2/2004	Implemented
Table 6-13	Coordination with Concurrent Projects							
CP5.1	5	Coordinated implementation programme with concurrent projects	To minimise potential impact where possible reduce the period of disturbance.	Project Proponent / Project Landscape Architect (Detailed Design Consultants)/ Contractor	Site	Throughout design and construction phases	TM-EIA Annex 18.	Implemented
<u>Landscape and Visual Impact (Operation Phase)</u>								
Table 6-14	Design of Engineering and Building Structures							
OP1.1	5	Where possible integrate the engineering and building structures, as far as technically feasible, with existing built structures. Select responsive The locations for the associated facilities away from landscape and visually sensitive areas.	To ensure the proposals are integrated with the existing landscape and visual context, and avoid cluster effect.	Project Engineer and Architect (Detailed Design Consultants)/ NA	Site	Throughout design phase	TM-EIA Annex 18 and BD	Implemented

Appendix B Implementation of Environmental Mitigation Measures (Status as of 31 July 2017)

EIA Ref.	EM&A Ref.	Recommended Mitigation Measures	Objectives of the Recommended Measure & Main Concerns to address	Who to implement the measure?	Location of the measure	When to implement the measure?	What requirements or standards for the measure to achieve?	Implementation status
OP1.2	5	Use of a responsive design for the disposition of the main elements including the locations of the proposed above ground structures.	To ensure the proposals are integrated with the existing landscape and visual context, and avoid cluster effect.	Project Engineer and Architect (Detailed Design Consultants)/ NA	Site	Throughout Design phase	TM-EIA Annex 18 and BD	Implemented
OP1.3	5	The disposition and height profile of the proposed ground structures should respond to the existing context.	To enhance the sense of visual integration with the existing context, avoid abrupt transitions between the existing and proposed built environment and reduce the apparent visual mass of the proposed developments.	Project Engineer and Architect (Detailed Design Consultants)/ NA	Site	Throughout design phase	TM-EIA Annex 18 and BD	Implemented
OP1.4	5	Creation of setbacks, articulating the development frontage, maintenance of view corridors and the utilisation of stepped or articulated height profile.	To enhance the sense of visual integration with the existing context, avoid abrupt transitions between the existing and proposed built environment and reduce the apparent visual mass of the proposed developments.	Project Engineer and Architect (Detailed Design Consultants)/ NA	Site	Throughout design phase	TM-EIA Annex 18 and BD	Implemented
OP1.5	5	Use of natural materials such as colour blocking, innovative surface treatments and vertical greening.	To reduce the apparent visual mass of the facilities.	Project Engineer and Architect (Detailed Design Consultants)/ NA	Site	Throughout design phase	TM-EIA Annex 18, HKPSG and BD	Implemented
OP1.6	5	Use of natural materials such as colour blocking, innovative surface treatments and vertical greening.	To reduce the apparent visual mass of the facilities.	Project Engineer and Architect (Detailed Design Consultants)/ Project Proponent	Site	Throughout design phase	TM-EIA Annex 18, HKPSG and BD	Implemented
OP1.7	5	Use of natural tones colour palette and non-reflective materials for outward facing building facades finishes.	To reduce the potential glare effect.	Project Engineer and Architect (Detailed Design Consultants)/ NA	Site	Throughout design phase	TM-EIA Annex 18, HKPSG and BD	Implemented

EIA Ref.	EM&A Ref.	Recommended Mitigation Measures	Objectives of the Recommended Measure & Main Concerns to address	Who to implement the measure?	Location of the measure	When to implement the measure?	What requirements or standards for the measure to achieve?	Implementation status
OP1.8	5	Incorporation of landscaped terraced edges where conditions allow particularly those fronting the public realm.	To reduce the apparent visual mass of the structure and create a more subtle transition with the pedestrian level streetscape.	Project Engineer and Architect (Detailed Design Consultants)/ NA	Site	Throughout design phase	TM-EIA Annex 18, HKPSG and BD	Implemented
OP1.9	5	Aesthetic design of architectural and track lighting sign shall follow the following design intention. - Directional and full cut off lighting is recommended particularly for recreation and roadside areas; - Minimize geographical spread of lighting, only applied for safety at the key access points and staircases; - Limited lighting intensity to meet the minimum safety and operational requirement; and - High-pressure sodium road lighting is recommended for more stringent light control.	To reduce the night-time glare effect to the surrounding environs, reducing spillage and thus visual impacts.	Project Engineer and Architect (Detailed Design Consultants)/ NA	Site	Through out operation phase	TM-EIA Annex 18	Implemented
Table 6-14		Roadside and Amenity Planting						
OP2.1	5	Utilise large ornamental trees to maximise the area of visible greenery, soften the interface between the proposed scheme and adjacent urban fabric and enhance the thermal comfort of adjacent spaces.	Provide a linkage with the existing landscape creating a more coherent landscape framework.	Project Landscape Architect(Detailed Design Consultants)/ Project Proponent	Site	Through out design phase	TM-EIA Annex 18, ETWB TCW No. 3/2006 & 2/2004, HKPSG and BD	Implemented
OP2.2	5	Planting proposals should respond to the need for visual access in the views from the adjacent neighbourhoods to the roadside or rural landscape. Whereas dense foliage plants shall be provided at other locations to screen and frame views, provide a more shaded environment for pedestrians and provide accents within the existing roadside planting.	Conserve and enhance the landscape interest.	Project Landscape Architect(Detailed Design Consultants)/ Project Proponent	Site	Through out design phase	TM-EIA Annex 18, ETWB TCW No. 3/2006 & 2/2004, HKPSG and BD	Implemented
OP2.3	5	The planting on sloping ground and areas adjacent to existing woodland shall utilise native species.	Improving the ecological connectivity between existing woodland habitats and creating a more unified and coherent landscape framework.	Project Landscape Architect(Detailed Design Consultants)/ Project Proponent	Site	Through out design phase	TM-EIA Annex 18, ETWB TCW No. 3/2006 & 2/2004, HKPSG and BD	Implemented

EIA Ref.	EM&A Ref.	Recommended Mitigation Measures	Objectives of the Recommended Measure & Main Concerns to address	Who to implement the measure?	Location of the measure	When to implement the measure?	What requirements or standards for the measure to achieve?	Implementation status
Table 6-14		Compensatory Planting Proposals						
OP3.1	5	Utilise all available spaces for new tree and shrub planting to screen views of the proposals and where this is not possible soften their architectural form.	To soften the architectural form and enhance their visual integration within the future landscape context.	Project Landscape Architect (IDC Consultants) / LCSD	Site	Through out design phase	TM-EIA Annex 18, ETWB TCW No. 3/2006 & 2/2004, HKPSG and BD	Implemented
OP3.2	5	New tree planting will be concentrated in the proposed amenity areas along the alignment and surrounding the stations, and providing infill planting between the retained and transplanted trees; and on the disturbed slope areas.	To restore and enhance existing landscape context.	Project Proponent / NA	Site	Through out design phase	TM-EIA Annex 18, ETWB TCW No. 3/2006 & 2/2004, HKPSG and BD	Implemented
OP3.3	5	The preliminary planting proposals for the proposed works shall adopt a compensatory planting ratio of 1:1 (new planting: trees recommended for felling) utilising a combination of mature to light standard sized stock in general roadside and planting areas adjacent to proposed stations and above ground structures.	To compensate the loss of existing trees.	Project Proponent / Project Landscape Architect (IDC Consultants)	Site	Through out design phase	TM-EIA Annex 18, ETWB TCW No. 3/2006 & 2/2004, HKPSG	Implemented
OP3.4	5	The retention of existing trees through their preservation in-situ, the transplantation of trees found to be in conflict with the proposed works and the successful establishment of the newly planted trees will form part of the roadside and slope planting enhancing the amenity of the local areas and providing for the thermal comfort of pedestrians.	To compensate the loss of existing trees.	Project Proponent / Project Landscape Architect (IDC Consultants)	Site	Through out design phase	TM-EIA Annex 18, ETWB TCW No. 3/2006 & 2/2004, HKPSG	Implemented
OP3.5	5	The proposed compensatory and new tree planting will utilise a combination of species native to Hong Kong and ornamental feature trees for the slope areas and those alongside the infrastructure corridors. The species selection for the areas adjacent to proposed stations and within the main urban areas will utilise a range of amenity tree species. These proposals will be subject to further development during the detailed design stage of the project.	To compensate the loss of existing trees.	Project Proponent / Project Landscape Architect (IDC Consultants)	Site	Through out design phase	TM-EIA Annex 18, ETWB TCW No. 3/2006 & 2/2004, HKPSG	Implemented

EIA Ref.	EM&A Ref.	Recommended Mitigation Measures	Objectives of the Recommended Measure & Main Concerns to address	Who to implement the measure?	Location of the measure	When to implement the measure?	What requirements or standards for the measure to achieve?	Implementation status
OP3.6	5	The preliminary planting proposals for the proposed works shall adopt a compensatory planting ratio of 1:1 (new planting: trees recommended for felling) utilising a combination of mature to light standard sized stock in general roadside and planting areas adjacent to proposed stations and above ground structures.	To compensate the loss of existing trees.	Project Proponent / Project Landscape Architect (IDC Consultants)	Site	Through out design phase	TM-EIA Annex 18, ETWB TCW No. 3/2006 & 2/2004, HKPSG	Implemented
OP3.7	5	The retention of existing trees through their preservation in-situ, the transplantation of trees found to be in conflict with the proposed works and the successful establishment of the newly planted trees will form part of the roadside and slope planting enhancing the amenity of the local areas and providing for the thermal comfort of pedestrians.	To compensate the loss of existing trees.	Project Proponent / Project Landscape Architect (IDC Consultants)	Site	Through out design phase	TM-EIA Annex 18, ETWB TCW No. 3/2006 & 2/2004, HKPSG	Implemented
OP3.8	5	The proposed compensatory and new tree planting will utilise a combination of species native to Hong Kong and ornamental feature trees for the slope areas and those alongside the infrastructure corridors. The species selection for the areas adjacent to proposed stations and within the main urban areas will utilise a range of amenity tree species. These proposals will be subject to further development during the detailed design stage of the project.	To compensate the loss of existing trees.	Project Proponent / Project Landscape Architect (IDC Consultants)	Site	Through out design phase	TM-EIA Annex 18, ETWB TCW No. 3/2006 & 2/2004, HKPSG	Implemented

EIA Ref.	EM&A Ref.	Recommended Mitigation Measures	Objectives of the Recommended Measure & Main Concerns to address	Who to implement the measure?	Location of the measure	When to implement the measure?	What requirements or standards for the measure to achieve?	Implementation status
Table 6-14	5	<p>Treatment of Retaining Wall and Slopes</p> <p>The proposed treatment of Retaining Wall and Slopes should be aesthetically enhanced through the use of soft landscape works including tree and shrub planting to give man-made slopes a more natural appearance blending into the local rural landscape.</p>	<p>The design seeks to visually integrate the engineered slope feature within the local landscape context.</p>	<p>Project Landscape Architect(Detailed Design Consultants)/ / LCSD or HyD</p>	Site	Through out design phase	<p>TM-EIA Annex 18, HKPSG and BD GEO Publication No. 1/2000 "Technical Guidelines on Landscape Treatment and Bio-engineering for Man-made Slopes and Retaining Walls" For HyD SIMAR slopes refer to Standard Requirements for Handover of Vegetation on to Highways Department (Rev.B).</p>	Implemented

EIA Ref.	EM&A Ref.	Recommended Mitigation Measures	Objectives of the Recommended Measure & Main Concerns to address	Who to implement the measure?	Location of the measure	When to implement the measure?	What requirements or standards for the measure to achieve?	Implementation status
OP4.2	5	Whip sized tree planting is preferred on the face of soil cut slopes and at the crest and toe of the slope, and within berm planters. The smaller, younger plant stock will adapt to their new growing conditions more quickly than larger sized stock and establish a naturalistic effect more rapidly.	The design seeks to visually integrate the engineered slope feature within the local landscape context.	Project Landscape Architect (Detailed Design Consultants)/ / LCSD or HyD	Site	Through out design phase	TM-EIA Annex 18, HKPSG and BD GEO Publication No. 1/2000 "Technical Guidelines on Landscape Treatment and Bio-engineering for Man-made Slopes and Retaining Walls" For HyD SIMAR slopes refer to Standard Requirements for Handover of Vegetation on to Highways Department (Rev.B).	Implemented
Table 6-14 Design of Noise Mitigation Structures								
OP5.1	5	Noise mitigation structures installed along the trackside should not be limited to the functional requirements of mitigating train noise. It should also include a requirement that these structures make a positive contribution to the urban / semi-rural landscape character of this area and by doing so improve the perceived landscape quality of the area. These barriers would be visible from some VSRs identified in the study.	To ensure the proposals are integrated with the existing landscape and visual context, and avoid cluster effect.	Project Engineer and Architect (Detailed Design Consultants)/ NA	Site	Throughout design phase	TM-EIA Annex 18 and BD	Implemented
OP5.2	5	Promote the innovative use of materials, such as Plexiglas, fibreglass, reinforced concrete etc, whilst remaining aware of the design life span of each of the elements incorporated in the design.	To ensure the proposals are integrated with the existing landscape and visual context, and avoid cluster effect.	Project Engineer and Architect (Detailed Design Consultants)/ NA	Site	Throughout design phase	TM-EIA Annex 18 and BD	Implemented

Appendix B Implementation of Environmental Mitigation Measures (Status as of 31 July 2017)

EIA Ref.	EM&A Ref.	Recommended Mitigation Measures	Objectives of the Recommended Measure & Main Concerns to address	Who to implement the measure?	Location of the measure	When to implement the measure?	What requirements or standards for the measure to achieve?	Implementation status
OP5.3	5	Reduce the visual effect of the structure through the use of form, materials, textures colours and tones.	To ensure the proposals are integrated with the existing landscape and visual context, and avoid cluster effect.	Project Engineer and Architect (Detailed Design Consultants)/ NA	Site	Throughout design phase	TM-EIA Annex 18 and BD	Implemented
OP5.4	5	Incorporation of articulation in the façade of the noise barriers / enclosures through the use of some transparent sections near the upper portion of the proposed structure.	To ensure the proposals are integrated with the existing landscape and visual context, and avoid cluster effect.	Project Engineer and Architect (Detailed Design Consultants)/ NA	Site	Throughout design phase	TM-EIA Annex 18 and BD	Implemented
OP5.5	5	Reflect the chromatic context of the surrounding urban landscape through the use of colour panels in the proposed noise barrier.	To ensure the proposals are integrated with the existing landscape and visual context, and avoid cluster effect.	Project Engineer and Architect (Detailed Design Consultants)/ NA	Site	Throughout design phase	TM-EIA Annex 18 and BD	Implemented
OP5.6	5	Utilise materials, which are non-reflective avoiding glare from incident sunlight.	To ensure the proposals are integrated with the existing landscape and visual context, and avoid cluster effect.	Project Engineer and Architect (Detailed Design Consultants)/ NA	Site	Throughout design phase	TM-EIA Annex 18 and BD	Implemented
Table 6-14	Design of Engineering Structures							
OP6.1	5	The landscape consultants have worked in unison with the engineers on the aesthetic aspects of the structures and their relationship with the landscape.	To ensure the proposals are integrated with the existing landscape and visual context, and avoid cluster effect.	Project Engineer and Landscape Architects (Detailed Design Consultants)/ NA	Site	Throughout design phase	TM-EIA Annex 18 and BD, ACABAS	Implemented
OP6.2	5	The structures shall aim to “touch” the ground as lightly as possible in order to minimise disturbance to the existing landscape and vegetation below the structures. This would be achieved by designing slender, rounded columns spaced the maximum distance apart. The viaducts would be constructed using pre-cast methods and launched from columns rather than scaffolding. The viaduct should be designed to achieve where appropriate a graceful, curving alignment.	To ensure the proposals are integrated with the existing landscape and visual context, and avoid cluster effect.	Project Engineer and Architect (Detailed Design Consultants)/ NA	Site	Throughout design phase	TM-EIA Annex 18 and BD, ACABAS	Implemented

Appendix B Implementation of Environmental Mitigation Measures (Status as of 31 July 2017)

EIA Ref.	EM&A Ref.	Recommended Mitigation Measures	Objectives of the Recommended Measure & Main Concerns to address	Who to implement the measure?	Location of the measure	When to implement the measure?	What requirements or standards for the measure to achieve?	Implementation status
OP6.3	5	Landform and vegetation in areas disturbed by construction works would be reinstated to blend with the existing landscape patterns or as discussed above.	To ensure the proposals are integrated with the existing landscape and visual context, and avoid cluster effect.	Project Engineer and Architect (Detailed Design Consultants)/ NA	Site	Throughout design phase	TM-EIA Annex 18 and BD, ACABAS	Implemented
OP6.4	5	Wherever light levels, the water regime and the requirements of the ecological mitigation measures permit, vegetation would be reinstated below the structures. Irrigation may be required in some locations and hard landscape solutions considered where the clearance is low. Planting would be used wherever possible to minimise the apparent height of structures and to soften their appearance in medium and long distance views.	To ensure the proposals are integrated with the existing landscape and visual context, and avoid cluster effect.	Project Engineer and Architect (Detailed Design Consultants)/ NA	Site	Throughout design phase	TM-EIA Annex 18 and BD, ACABAS	Implemented
OP6.2	5	The design of the proposed structures should avoid unnecessary visual clutter, this would be achieved through the co-ordination of the various engineering disciplines involved to arrive at innovative design solutions.	To ensure the proposals are integrated with the existing landscape and visual context, and avoid cluster effect.	Project Engineer and Architect (Detailed Design Consultants)/ NA	Site	Throughout design phase	TM-EIA Annex 18 and BD, ACABAS	Implemented
OP6.5	5	Fair faced concrete would not be used for parapets to minimise glare from the structure and to avoid the visually detracting effect of staining.	To ensure the proposals are integrated with the existing landscape and visual context, and avoid cluster effect.	Project Engineer and Architect (Detailed Design Consultants)/ NA	Site	Throughout design phase	TM-EIA Annex 18 and BD, ACABAS	Implemented
OP6.6	5	Drainage structures would where possible be concealed within the structure of the proposed viaducts.	To ensure the proposals are integrated with the existing landscape and visual context, and avoid cluster effect.	Project Engineer and Architect (Detailed Design Consultants)/ NA	Site	Throughout design phase	TM-EIA Annex 18 and BD, ACABAS	Implemented
Table 6-14	Reinstatement and Creation of Open Spaces and Gardens							
OP7.1	5	The landscape consultants have worked in unison with the engineers on the aesthetic aspects for Reinstatement and Creation of Open Spaces and Gardens	To ensure the proposals are integrated with the existing landscape and visual context, and avoid cluster effect.	Project Engineer and Landscape Architects (Detailed Design Consultants)/ NA	Site	Throughout Design and Construction phases	TM-EIA Annex 18 and BD, ACABAS	Implemented

Appendix B Implementation of Environmental Mitigation Measures (Status as of 31 July 2017)

EIA Ref.	EM&A Ref.	Recommended Mitigation Measures	Objectives of the Recommended Measure & Main Concerns to address	Who to implement the measure?	Location of the measure	When to implement the measure?	What requirements or standards for the measure to achieve?	Implementation status
Hazard to Life								
A7A	6	Improved truck design to reduce the amount of combustibles in, front exhaust spark arrester, 1 x 9 kg water based and 1 x 9 kg dry chemical powder fire extinguishers for a vehicle with gross weight up to 9 tonnes, and 2 x 2.5kg dry powder and 2 x 10-litre foam fire extinguishers to be provided for a vehicle of 9 tonnes and above, and a hand-held lightning detector to be provided in the vehicle. This should be combined with monthly vehicle inspection.	To meet the ALARP requirement	MTRC/ Contractor	Explosive Magazine	Construction phase		Implemented
A7A	6	Blasting activities including storage and transport of explosives should be supervised and audited by competent site staff to ensure strict compliance with the blasting permit conditions.	To ensure that the risks from the proposed explosives storage and transport would not be unacceptable	MTRC / Contractor	Works areas at which explosives would be stored and/or used	Construction phase	Dangerous Goods Ordinance	Implemented
A7A	6	Only the required quantity of explosives for a particular blast should be transported to avoid the return of unused explosives to the magazine. The number of return trips to the magazine with the full load of explosives or partial load should be minimised by proper co-ordination between blasting and delivery. If disposal is required for small quantities, disposal should be made in a controlled and safe manner by a Registered Shotfirer.	To reduce the risk during explosives transport	MTRC/ Contractor	Works areas at which explosives would be stored and/ or used	Construction phase		Implemented
A7A	6	The explosive truck accident frequency should be minimized by implementing a dedicated training programme for both the driver and his attendants, including regular briefing sessions, implementation of a defensive driving attitude. In addition, drivers should be selected based on good safety record, and medical checks.	To meet the ALARP requirement.	MTRC/ Contractor	-	Construction phase		Implemented
A7A	6	The contractor should as far as practicable combine the explosive deliveries for a given work area.	To meet the ALARP requirement.	MTRC/ Contractor	-	Construction phase		Implemented

Appendix B Implementation of Environmental Mitigation Measures (Status as of 31 July 2017)

EIA Ref.	EM&A Ref.	Recommended Mitigation Measures	Objectives of the Recommended Measure & Main Concerns to address	Who to implement the measure?	Location of the measure	When to implement the measure?	What requirements or standards for the measure to achieve?	Implementation status
A7A	6	The explosive truck fire involvement frequency should be minimized by implementing a better emergency response and training to make sure the adequate fire extinguishers are used and attempt is made to evacuate the area of the incident or securing the explosive load if possible. All explosive vehicles should also be equipped with bigger capacity AFFF-type extinguishers.	To meet the ALARP requirement.	MTRC/ Contractor	-	Construction phase		Implemented
A7A	6	A minimum headway between two consecutive trucks conveys of at least 10 min is recommended.	To ensure that the risk from the proposed explosives transport would not be unacceptable	MTRC/ Contractor	Along explosives transport route	Construction phase		Implemented
A7A	6	Use only experienced driver(s) with good safety record for explosive vehicle(s). Training should be provided to ensure it covers all major safety subjects.	To ensure safe transport of explosives	MTRC/ Contractor	At suitable location	Construction phase		Implemented
A7A	6	Develop procedure to ensure that parking space on the site is available for the explosive truck. Confirmation of parking space should be communicated to truck drivers before delivery.	To ensure that the risks from the proposed explosives storage and transport would not be unacceptable	MTRC/ Contractor	Explosive magazine	Construction phase		Implemented
A7A	6	Delivery vehicles shall not be permitted to remain unattended within the magazine site (or appropriately wheel-locked).	To reduce the risk of fire within the magazine	MTRC / Contractor	Explosive Magazine	Construction phase		Implemented
A7A	6	Good house-keeping within and outside of the magazine to ensure that combustible materials (including vegetation) are removed and not allowed to accumulate.	To reduce the risk of fire within the magazine	MTRC / Contractor	Explosive Magazine	Construction phase		Implemented
A7A	6	Detonators shall not be transported in the same vehicle with other Class 1 explosives.	To reduce the risk of explosion during the transport of cartridged emulsion	MTRC / Contractor		Construction phase		Implemented
A7A	6	Emergency plan (i.e. magazine operational manual) shall be developed to address uncontrolled fire in magazine area. The case of fire near an explosive carrying truck in jammed traffic should also be covered. Drill of the emergency plan should be carried out at regular intervals.	To reduce the risk of fire	MTRC/ Contractor	Explosive Magazine and along explosives transport route	Construction phase		Implemented
A7A	6	Adverse weather working guideline should be developed to clearly define procedure for transport explosives during thunderstorm.	To ensure safe transport of explosives	MTRC/ Contractor	Along explosives transport route	Construction phase		Implemented
A7A	6	During transport of the explosives within the tunnel, hot work should not be permitted.	To ensure safe transport of explosives	MTRC/ Contractor	Along explosives transport route	Construction phase		Implemented

Appendix B Implementation of Environmental Mitigation Measures (Status as of 31 July 2017)

EIA Ref.	EM&A Ref.	Recommended Mitigation Measures	Objectives of the Recommended Measure & Main Concerns to address	Who to implement the measure?	Location of the measure	When to implement the measure?	What requirements or standards for the measure to achieve?	Implementation status
A7A	6	Ensure that UN 1.4B packaging of detonators remains intact until handed over at blasting site.	To reduce the risk of explosion during the transport of detonator	MTRC/ Contractor	-	Construction phase		Implemented
A7A	6	Contractor to ensure that any electro-explosive devices are sufficiently shielded from radio frequency radiation hazards.	To reduce the risk of explosion during the transport of detonators	MTRC/ Contractor	-	Construction phase		Implemented
A7A	6	Steel vehicle tray welded to a steel vertical fire screen should be mounted at least 150 mm behind the drivers cab and 100 mm from the steel cargo compartment, the vertical screen shall protrude 150 mm in excess of all three (3) sides of the steel cargo compartment.	To reduce the risk during explosives transport.	MTRC/ Contractor	-	Construction phase		Implemented
A7A	6	Ensure cartridged emulsion with high water content should be preferred. Also, the emulsion with perchlorate formulation should be avoided.	To ensure safe explosives to be used	MTRC/ Contractor	-	Construction phase		Implemented
A7A	6	Traffic Management should be implemented within the temporary magazine site, to ensure that no more than 1 vehicle will be loaded at any time, in order to avoid accidents involving multiple vehicles within the site boundary. Based on the construction programme, considering that 6 trucks could be loaded over a peak 2 hour period, this is considered feasible.	To ensure that the risks from the proposed explosives storage and transport would not be unacceptable	MTRC/ Contractor	-	Construction phase		Implemented
A7A	6	The design of the fill slope close to the temporary magazine site should consider potential washout failures and incorporate engineering measures to prevent a washout causing damage to the temporary magazine stores	To ensure that the risks from the proposed explosives storage would not be unacceptable	MTRC/ Contractor	-	Construction phase		Implemented
A7A	6	The security plan should address different alert security level to reduce opportunity for arson / deliberate initiation of explosives. The corresponding security procedure should be implemented with respect to prevailing security alert status announced by the Government.	To ensure that the risks from the proposed explosives storage would not be unacceptable	MTRC/ Contractor	-	Construction phase		Implemented
A7A	6	A suitable work control system should be introduced, such as an operational manual including Permit-to-Work system.	To ensure that the risks from the proposed explosives storage would not be unacceptable	MTRC/ Contractor	-	Construction phase		Implemented
A7A	6	The magazine building shall be regularly checked for water seepage through the roof, walls or floor.	To ensure that the risks from the proposed explosives storage would not be unacceptable	MTRC/ Contractor	-	Construction phase		Implemented

EIA Ref.	EM&A Ref.	Recommended Mitigation Measures	Objectives of the Recommended Measure & Main Concerns to address	Who to implement the measure?	Location of the measure	When to implement the measure?	What requirements or standards for the measure to achieve?	Implementation status
Waste Management (Construction Phase)								
8.5.1.1	7	<p>Good Site Practices Recommendations for good site practices during the construction activities include:</p> <ul style="list-style-type: none"> Nomination of an approved person, such as a site manager, to be responsible for good site practices, arrangements for collection and effective disposal to an appropriate facility, of all wastes generated at the site Training of site personnel in proper waste management and chemical handling procedures Provision of sufficient waste disposal points and regular collection of waste Appropriate measures to minimise windblown litter and dust/odour during transportation of waste by either covering trucks or by transporting wastes in enclosed containers Provision of wheel washing facilities before the trucks leaving the works area so as to minimise dust introduction from public road Well planned delivery programme for offsite disposal such that adverse environmental impact from transporting the C&D material is not anticipated Provision of cover for the stockpile material, sand bag or earth bund as barrier to prevent material from washing away and entering the drains 	To reduce waste generation	MTRC / Contractor	Construction Work Sites (General)	During Construction	<p>Waste Disposal Ordinance (Cap.354);</p> <p>Waste Disposal (Chemical Wastes) (General) Regulation (Cap 354) and</p> <p>ETWBTC No. 15/2003, Waste Management on Construction Site</p>	Implemented

EIA Ref.	EM&A Ref.	Recommended Mitigation Measures	Objectives of the Recommended Measure & Main Concerns to address	Who to implement the measure?	Location of the measure	When to implement the measure?	What requirements or standards for the measure to achieve?	Implementation status
8.5.1.2	7	<p>Waste Reduction Measures Recommendations to achieve waste reduction include:</p> <ul style="list-style-type: none"> Sort C&D material from demolition and decommissioning of the existing facilities to recover recyclable portions such as metals Segregation and storage of different types of waste in different containers, skips or stockpiles to enhance reuse or recycling of materials and their proper disposal Encourage collection of aluminium cans by providing separate labelled bins to enable this waste to be segregated from other general refuse generated by the work force Proper storage and site practices to minimise the potential for damage or contamination of construction materials Plan and stock construction materials carefully to minimise amount of waste generated and avoid unnecessary generation of waste. 	For perform waste reduction	MTRC / Contractor	Construction Work Sites (General)	During Construction	<p>Waste Disposal Ordinance (Cap.354);</p> <p>Waste Disposal (Chemical Wastes) (General) Regulation; Land (Miscellaneous Provisions) Ordinance (Cap. 28)</p>	Implemented

EIA Ref.	EM&A Ref.	Recommended Mitigation Measures	Objectives of the Recommended Measure & Main Concerns to address	Who to implement the measure?	Location of the measure	When to implement the measure?	What requirements or standards for the measure to achieve?	Implementation status
8.5.1.3	7	<p>C&D Material</p> <p>In order to minimise impacts resulting from collection and transportation of C&D material for off-site disposal, the excavated materials should be reused on-site as backfilling material as far as practicable. In addition, C&D material generated from excavation works could be reused as rock material in local projects that require public fill for reclamation and earth filling purposes, say, 'Hong Kong – Zhuhai – Macao Bridge' in association with Hong Kong Boundary Crossing Facilities and Hong Kong Link Road, Central-Wanchai Bypass and Wanchai Development Phase II project (subject to further coordination). The surplus rock and other inert C&D material should be disposed of at the Government's Public Fill Reception Facilities (PFRFs), for beneficial use by other projects in the HKSAR, or transported to Mainland China via CEDD for use by other suitable projects in the Mainland. C&D waste generated from general site clearance and tree felling works would require disposal to the designated landfill site. Other mitigation requirements are listed below:</p> <ul style="list-style-type: none"> • A Waste Management Plan should be prepared and • In order to monitor the disposal of C&D material and solid wastes at public filling facilities and landfills, and to control fly-tipping, a trip-ticket system (e.g. ETWB TCW No. 31/2004) should be included. 	To minimize impacts resulting from collection and transportation of C&D material for off-site disposal	MTRC / Contractor	Construction Work Sites (General)	During Construction	ETWB TCW No. 31/2004	Implemented
8.5.1.4	7	<p>General Refuse</p> <p>General refuse should be stored in enclosed bins or compaction units separate from C&D material. A reputable waste collector should be employed by the contractor to remove general refuse from the site, separately from C&D material. Preferably an enclosed and covered area should be provided to reduce the occurrence of 'wind blown' light material.</p>	To minimize impacts resulting from collection and transportation of general refuse for off-site disposal	MTRC / Contractor	Construction Work Sites (General)	During Construction	Public Health and Municipal Services Ordinance (Cap. 132) - Public Cleansing and Prevention of Nuisances Regulation	Implemented

EIA Ref.	EM&A Ref.	Recommended Mitigation Measures	Objectives of the Recommended Measure & Main Concerns to address	Who to implement the measure?	Location of the measure	When to implement the measure?	What requirements or standards for the measure to achieve?	Implementation status
8.5.1.5	7	<p>Chemical Waste</p> <p>If chemical wastes are produced at the construction site, the Contractor would be required to register with the EPD as a chemical waste producer and to follow the guidelines stated in the <i>Code of Practice on the Packaging Labelling and Storage of Chemical Wastes</i>. Good quality containers compatible with the chemical wastes should be used, and incompatible chemicals should be stored separately. Appropriate labels should be securely attached on each chemical waste container indicating the corresponding chemical characteristics of the chemical waste, such as explosive, flammable, oxidizing, irritant, toxic, harmful, corrosive, etc. The Contractor should use a licensed collector to transport and dispose of the chemical wastes, to either the approved Chemical Waste Treatment Centre, or another licensed facility, in accordance with the Waste Disposal (Chemical Waste) (General) Regulation.</p>	To minimize impacts resulting from collection and transportation of chemical waste for off-site disposal	MTRC / Contractor	Construction Work Sites (General)	During Construction	Code of Practice on the Packaging, Labelling and Storage of Chemical Wastes, Waste Disposal (Chemical Waste) (General) Regulation	Implemented
8.5.1.6	7	<p>Marine Dredged Sediment</p> <p>The sediment at the pier site would be dredged and transferred to barges for subsequent disposal. Release of dredged sediment into the surrounding water should be avoided. It is recommended that the distance between the barge and the dredging point be shortened as far as possible to avoid dropping of sediment from the close grab to the seawater.</p>	To minimise potential impacts on water quality	MTRC/ Contractor	Dredging/ excavation area required for installation of the pier/pier structure in Aberdeen Channel	During marine construction works	ETWB TCW No. 34/2002	Implemented
8.5.1.6	7	<p>Category H material was identified at the grab sampling location at the dredging/excavation site. As there was no exceedance of 10xLCEL for the tested parameters, the sediment to be dredged at this location should be disposed of at a confined marine disposal site. The Project Proponent should agree with MFC on the allocation of disposal site and the Contractor should apply a dumping permit from EPD prior to the dredging / excavation works.</p>	To prevent cross contamination of waste.	MTRC/ Contractor	Dredging/ excavation area with Category H material	During marine construction works	ETWB TCW No. 34/2002	Implemented

EIA Ref.	EM&A Ref.	Recommended Mitigation Measures	Objectives of the Recommended Measure & Main Concerns to address	Who to implement the measure?	Location of the measure	When to implement the measure?	What requirements or standards for the measure to achieve?	Implementation status
Waste Management (Operation Phase)								
8.5.2.1	7	<p>General Refuse</p> <p>General refuse should be collected on daily basis and delivered to the refuse collection point accordingly. A reputable waste collector should be employed to remove general refuse regularly to avoid odour nuisance or pest and vermin problem. Recycling containers are recommended to be provided to encourage recycling aluminium cans and waste paper.</p>	To minimize impacts resulting from collection and transportation of general refuse for off-site disposal	MTRC	Stations and depot	During Operation	Public Health and Municipal Services Ordinance (Cap. 132) - Public Cleansing and Prevention of Nuisances Regulation	Being implemented
8.5.2.2	7	<p>Industrial Waste</p> <p>Similar to general refuse, a reputable waste collector should be employed to remove industrial waste regularly to avoid accumulation. Scrap materials such as metals can be recycled if uncontaminated.</p>	To minimize impacts resulting from collection and transportation of industrial waste for off-site disposal	MTRC	Stations and depot	During Operation	Public Health and Municipal Services Ordinance (Cap. 132) - Public Cleansing and Prevention of Nuisances Regulation	Being implemented
8.5.2.3	7	<p>Chemical Waste</p> <ul style="list-style-type: none"> Register with the EPD as a chemical waste producer should be obtained and guidelines stated in the <i>Code of Practice on the Packaging, Labelling and Storage of Chemical Wastes</i> should be followed. Good quality containers compatible with the chemical wastes should be used, and incompatible chemicals should be stored separately. Appropriate labels should be securely attached on each chemical waste container indicating the corresponding chemical characteristics of the chemical waste, such as explosive, flammable, oxidizing, irritant, toxic, harmful, corrosive, etc. Licensed collector should be deployed to transport and dispose of the chemical wastes, to either the approved Chemical Waste Treatment Centre, or another licensed facility, in accordance with the Waste Disposal (Chemical Waste) (General) Regulation. 	To minimize impacts resulting from collection and transportation of chemical waste for off-site disposal	MTRC	Stations and depot	During Operation	Waste Disposal (Chemical Waste) (General) Regulation Code of Practice on the Packaging, Labelling and Storage of Chemical Waste	Being implemented
Land Contamination (Construction Phase)								

EIA Ref.	EM&A Ref.	Recommended Mitigation Measures	Objectives of the Recommended Measure & Main Concerns to address	Who to implement the measure?	Location of the measure	When to implement the measure?	What requirements or standards for the measure to achieve?	Implementation status
9.7.1	8	<p>The following measures should be implemented for contaminated material excavation and transportation (if any):</p> <ul style="list-style-type: none"> • To minimize the chance for construction workers' to come into contact with contaminated materials, bulk earth-moving excavation equipment should be employed; • Contact with contaminated materials can be minimised by wearing appropriate clothing and personal protective equipment such as gloves and masks (especially when interacting directly with contaminated material), provision of washing facilities and prohibition of smoking and eating on site; • Stockpiling of contaminated excavated materials on site should be avoided as far as possible; • The use of contaminated soil for landscaping purpose should be avoided unless pre-treatment was carried out; • Vehicles containing any excavated materials should be suitably covered to reduce dust emissions and/or release of contaminated wastewater; • Truck bodies and tailgates should be sealed to stop any discharge; • Only licensed waste haulers should be used to collect and transport contaminated material to treatment/disposal site and with the implementation of tracking system to avoid fly tipping; • Speed control for trucks carrying contaminated materials should be carried out; • Observe all relevant regulations in relation to waste handling, such as Waste Disposal Ordinance (Cap 354), Waste Disposal (Chemical Waste) (General) Regulation (Cap 354) and obtain all necessary permits where required; and • Maintain records of waste generation and disposal quantities and disposal arrangements. 	To minimize as much as possible any nuisance generated in relation to land remediation activities. At the same time, to protect all personnel from possible risk associated with land remediation activities.	MTRC / Contractor	All site areas	During Construction	EIA Recommendations	Implemented

EIA Ref.	EM&A Ref.	Recommended Mitigation Measures	Objectives of the Recommended Measure & Main Concerns to address	Who to implement the measure?	Location of the measure	When to implement the measure?	What requirements or standards for the measure to achieve?	Implementation status
Land Contamination (Operation Phase)								
9.7.2	8	Defined procedures in handling chemicals should be implemented as part of MTRCL company policy. All relevant operational procedures should be strictly followed to avoid land contamination.	To minimize as much as possible any risk in association with land contamination during operation of the Project	MTRC	All areas within the Project	During Operation	EIA Recommendations	Being implemented
Air Quality Impact (Construction Phase)								
10.6.2	9	Specific Dust Control Measures	To minimize adverse dust emission generated from various construction activities of the works sites	Contractor	Construction Works Sites	During Construction	EIA Recommendations	Implemented
		<ul style="list-style-type: none"> For the unloading of spoil from trucks at barging point, installation of 3-sided screen with top and the provision of water sprays at the discharge point should be provided 						
		<ul style="list-style-type: none"> Watering every working hour for 12 hours a day on exposed soil areas on active works areas and paved haul roads to reduce dust emissions 						
		<ul style="list-style-type: none"> The rock crushing facilities with maximum daily output of over 1000m³ per day should be enclosed including unloading locations and a fabric baghouse/cartridge filter type dust extraction and collection system or equivalent system with 99% or more dust removal efficiency should be installed for the treatment of the emissions from rock crushing and screening processes. 						
10.6.2	9	Best practices for dust control are required. A control programme can be instigated to monitor the construction process in order to enforce dust controls and modify methods of works where feasible to reduce the dust emission down to acceptable levels. The following best practices for dust control should be implemented throughout the construction period: Disturbed Parts of the Roads	To minimize adverse dust emission generated from various construction activities of the works sites	Contractor	Construction Works Sites	During Construction	Air Pollution Control (Construction Dust) Regulation, EPD's Best Practicable Means and EIA Recommendation	Implemented
		<ul style="list-style-type: none"> Each and every main temporary access should be paved with concrete, bituminous hardcore materials or metal plates and kept clear of dusty materials; or 						

EIA Ref.	EM&A Ref.	Recommended Mitigation Measures	Objectives of the Recommended Measure & Main Concerns to address	Who to implement the measure?	Location of the measure	When to implement the measure?	What requirements or standards for the measure to achieve?	Implementation status
		<ul style="list-style-type: none"> • Unpaved parts of the road would be sprayed with water or a dust suppression chemical so as to keep the entire road surface wet. <p>Exposed Earth</p> <ul style="list-style-type: none"> • Exposed earth should be properly treated by compaction, hydroseeding, vegetation planting or seating with latex, vinyl, bitumen within six months after the last construction activity on the site or part of the site where the exposed earth lies. <p>Loading, Unloading or Transfer of Dusty Materials</p> <ul style="list-style-type: none"> • All dusty materials should be sprayed with water immediately prior to any loading or transfer operation so as to keep the dusty material wet. <p>Debris Handling</p> <ul style="list-style-type: none"> • Any debris should be covered entirely by impervious sheeting or stored in a debris collection area sheltered on the top and the three sides. • Before debris is dumped into a chute, water should be sprayed so that it remains wet when it is dumped. ▪ For the minor blasting at WCH Depot, tarpaulin covers would be provided on the steel screens to prevent the dust from spreading out, and the whole blasting area would be watered before and after each blast in order to help contain the dust and fumes. <p>Transport of Dusty Materials</p> <ul style="list-style-type: none"> • Vehicle used for transporting dusty materials/ spoil should be covered with tarpaulin or similar material. The cover should extend over the edges of the sides and tailboards. <p>Wheel Washing</p> <ul style="list-style-type: none"> • Vehicle wheel washing facilities should be provided at each construction site exit. 						

EIA Ref.	EM&A Ref.	Recommended Mitigation Measures	Objectives of the Recommended Measure & Main Concerns to address	Who to implement the measure?	Location of the measure	When to implement the measure?	What requirements or standards for the measure to achieve?	Implementation status
		<p>Stone Crushing Plant</p> <ul style="list-style-type: none"> The control measures listed in EPD's A Guidance Note on the Best Practicable Means for Mineral Works (Stone Crushing Plants) BPM 11/1) should be followed, where appropriate. <p>Concrete Batching Plant</p> <ul style="list-style-type: none"> The loading, unloading, handling, transfer or storage of dusty materials should be carried in a totally enclosed system. All dust-laden air or waste gas generated by the process operations should be properly extracted and vented to fabric filtering system. The control measures listed in EPD's A guidance note on the best practicable means for cement works (concrete batching plant) (BPM 3/2) should be followed, where appropriate. <p>Good Site Management</p> <ul style="list-style-type: none"> The Contractor should maintain high standard of housekeeping to prevent emission of fugitive dust emission. Loading, unloading, handling and storage of raw materials, wastes or by-products should be carried out in a manner so as to minimize the release of visible dust emission. Any piles of materials accumulated on or around the work areas should be cleaned up regularly. Cleaning, repair and maintenance of all plant facilities within the work areas should be carried out in a manner minimizing generation of fugitive dust emissions. The material should be handled properly to prevent fugitive dust emission before cleaning. 						

EIA Ref.	EM&A Ref.	Recommended Mitigation Measures	Objectives of the Recommended Measure & Main Concerns to address	Who to implement the measure?	Location of the measure	When to implement the measure?	What requirements or standards for the measure to achieve?	Implementation status
Cultural Heritage Impact (Construction Phase)								
11.7.1.1	10	Archaeological watching brief during the construction phase is recommended for areas highlighted as having some archaeological potential (The works sites that will require archaeological watching brief can be found in the following figures in the main report: Harcourt Garden (Figure 11.22 of EIA Report), Wong Chuk Hang San Wai (WS10) in Figure 11.35 of EIA Report and Works Sites S7, S7c, S7d and S7e (Figure 11.28 of EIA Report)	To identify and record any archaeological material or features revealed during the excavation phase of the works schedule	MTRC/ Contractor	Admiralty: Harcourt Garden Works Site; Wong Chuk Hang: Works Sites S7c,d,e, Works Site S7, Pier Columns within Works Site S10	During Construction	Antiquities and Monuments Ordinance	Implemented

FIGURES

Figures 1 to 2
Works Areas of the Project

Figures 3 to 6
Location of Construction Air Quality
Monitoring Stations

Figures 7 to 8
Location of Construction Noise
Monitoring Stations

Figure 1 – Works Areas of the Project (1 of 2)

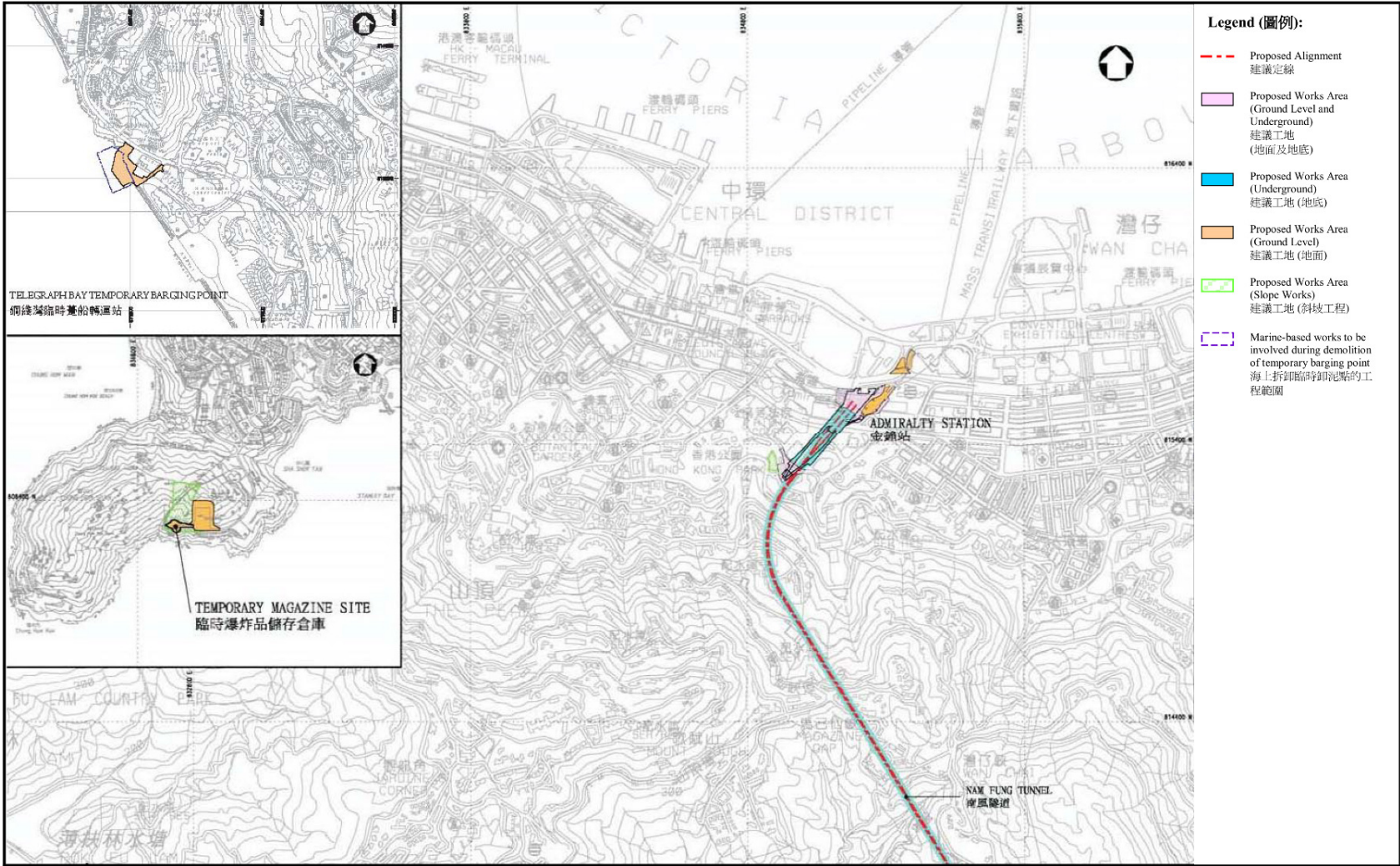

Figure 2 – Works Areas of the Project (2 of 2)

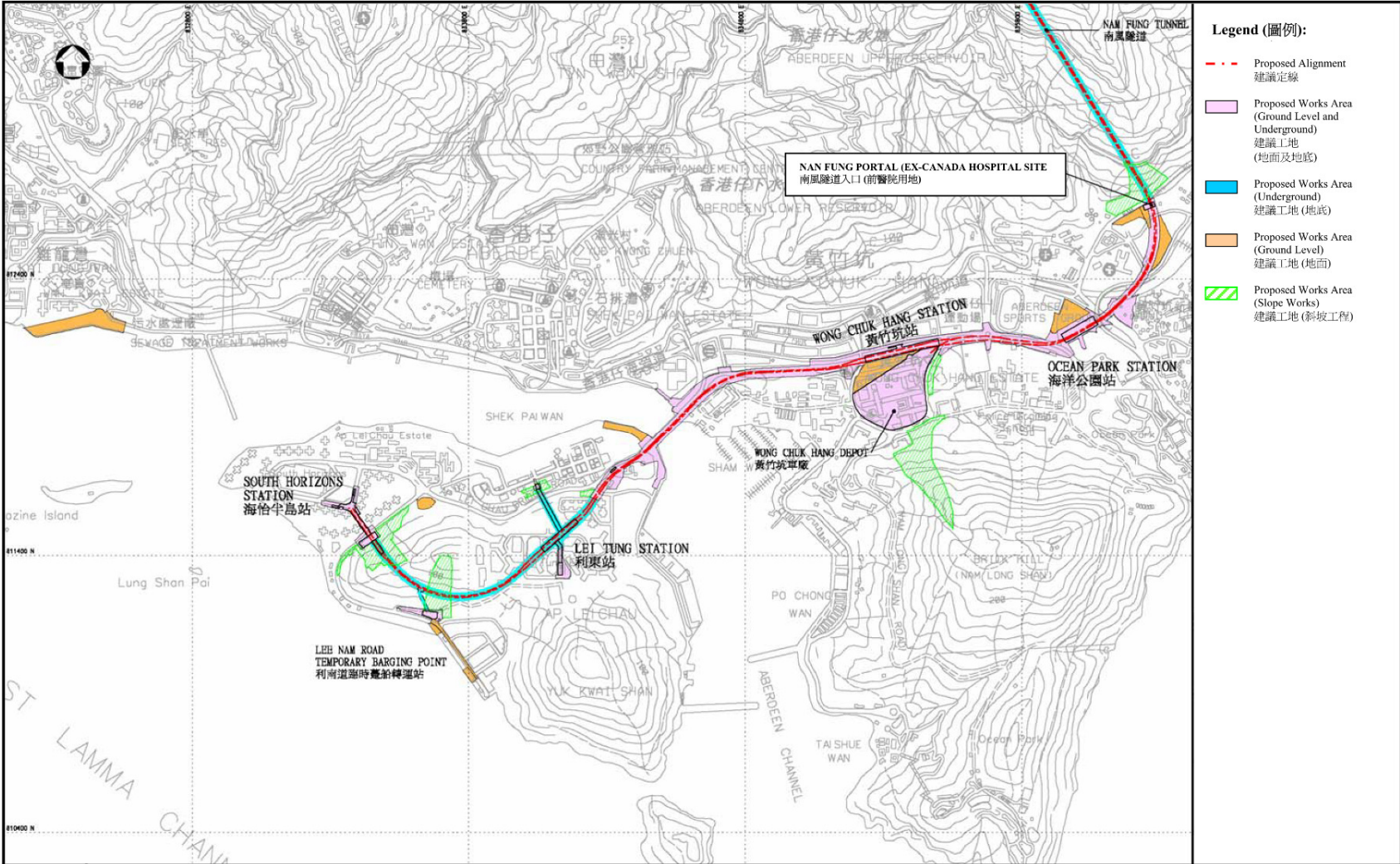

Figure 3 – Location of Construction Air Quality Monitoring Stations (1 of 4)

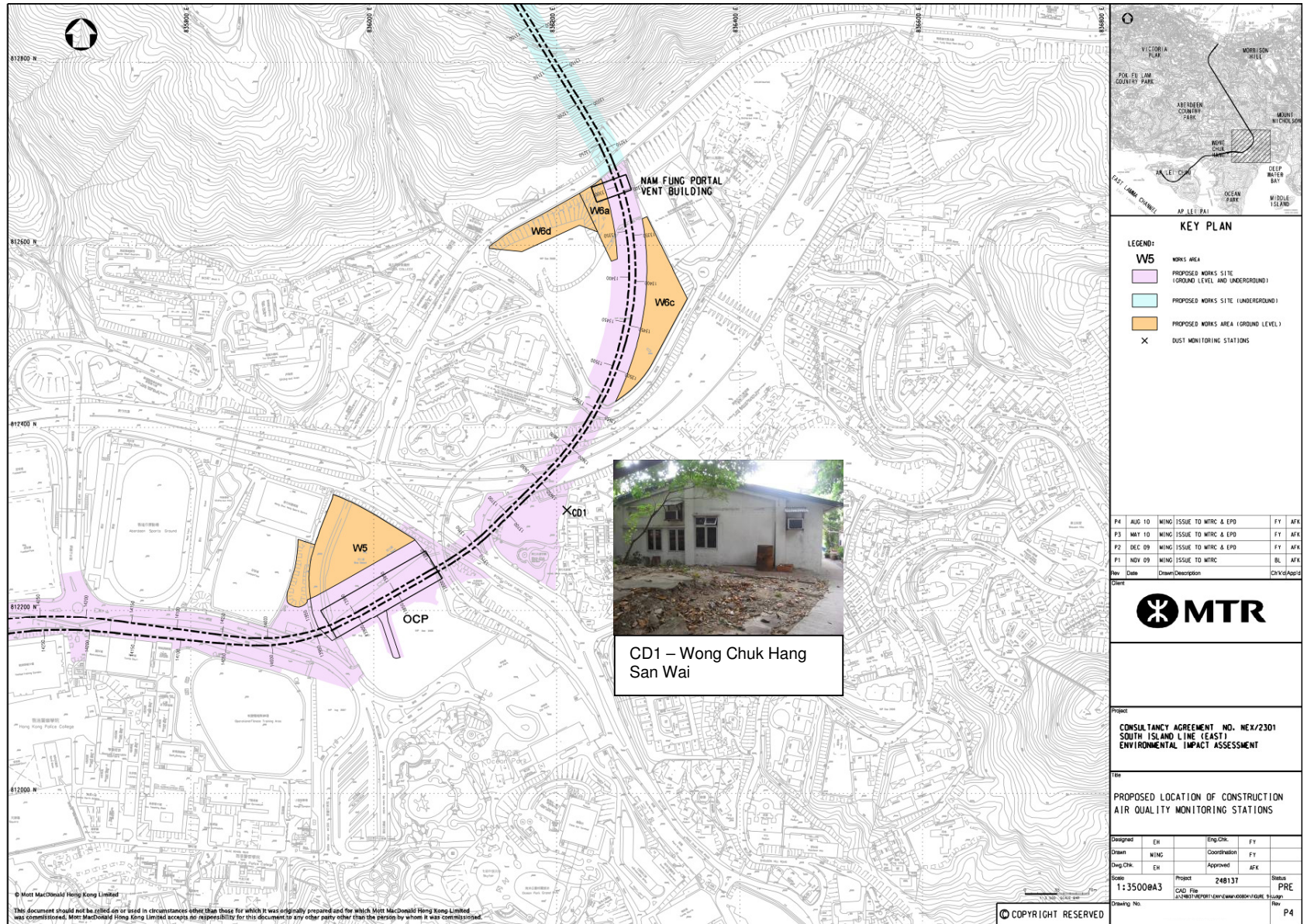

Figure 4 – Location of Construction Air Quality Monitoring Stations (2 of 4)

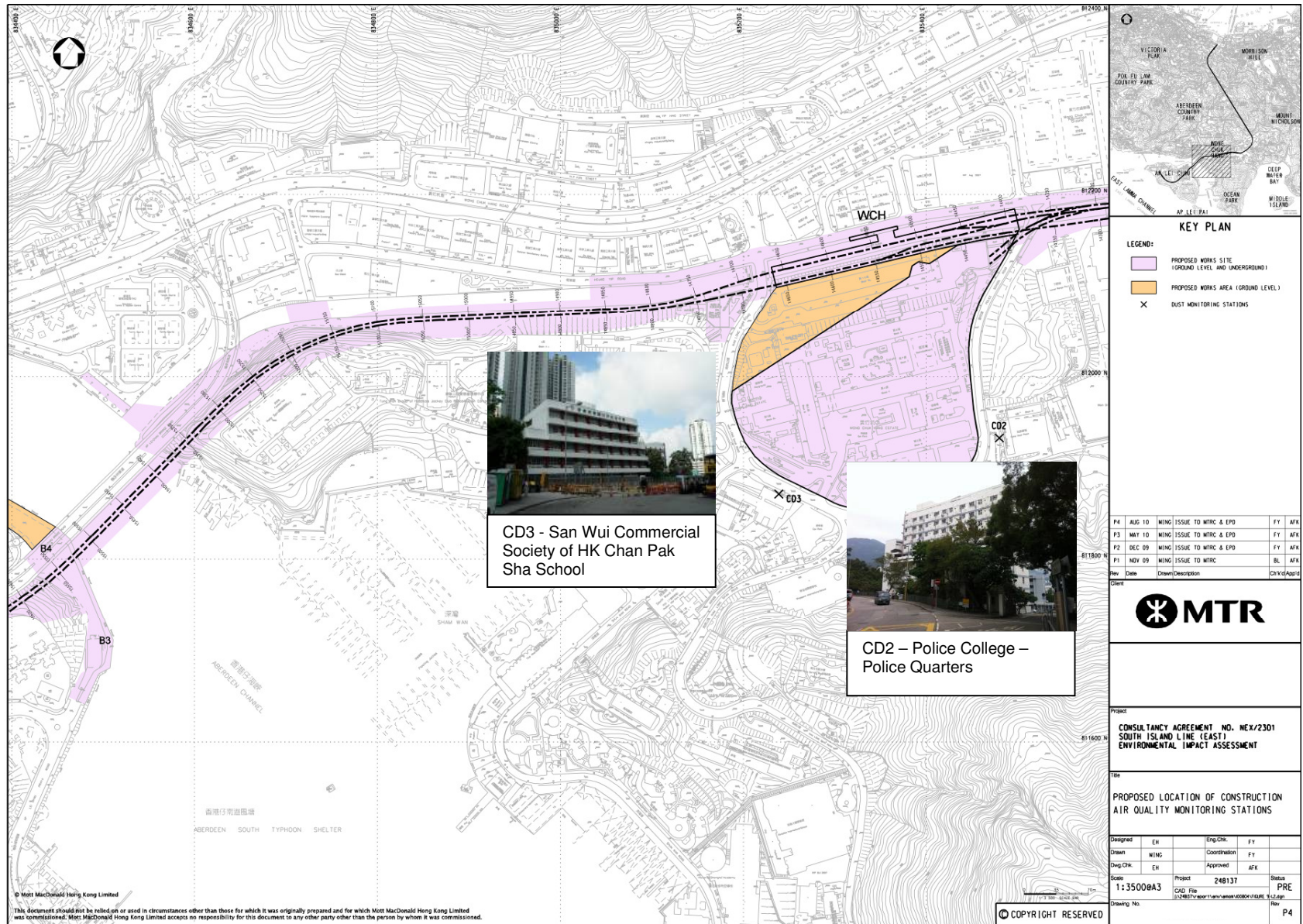

Figure 5 – Location of Construction Air Quality Monitoring Stations (3 of 4)



Figure 6 – Location of Construction Air Quality Monitoring Stations (4 of 4)



Figure 7 – Location of Construction Noise Monitoring Stations (1 of 2)

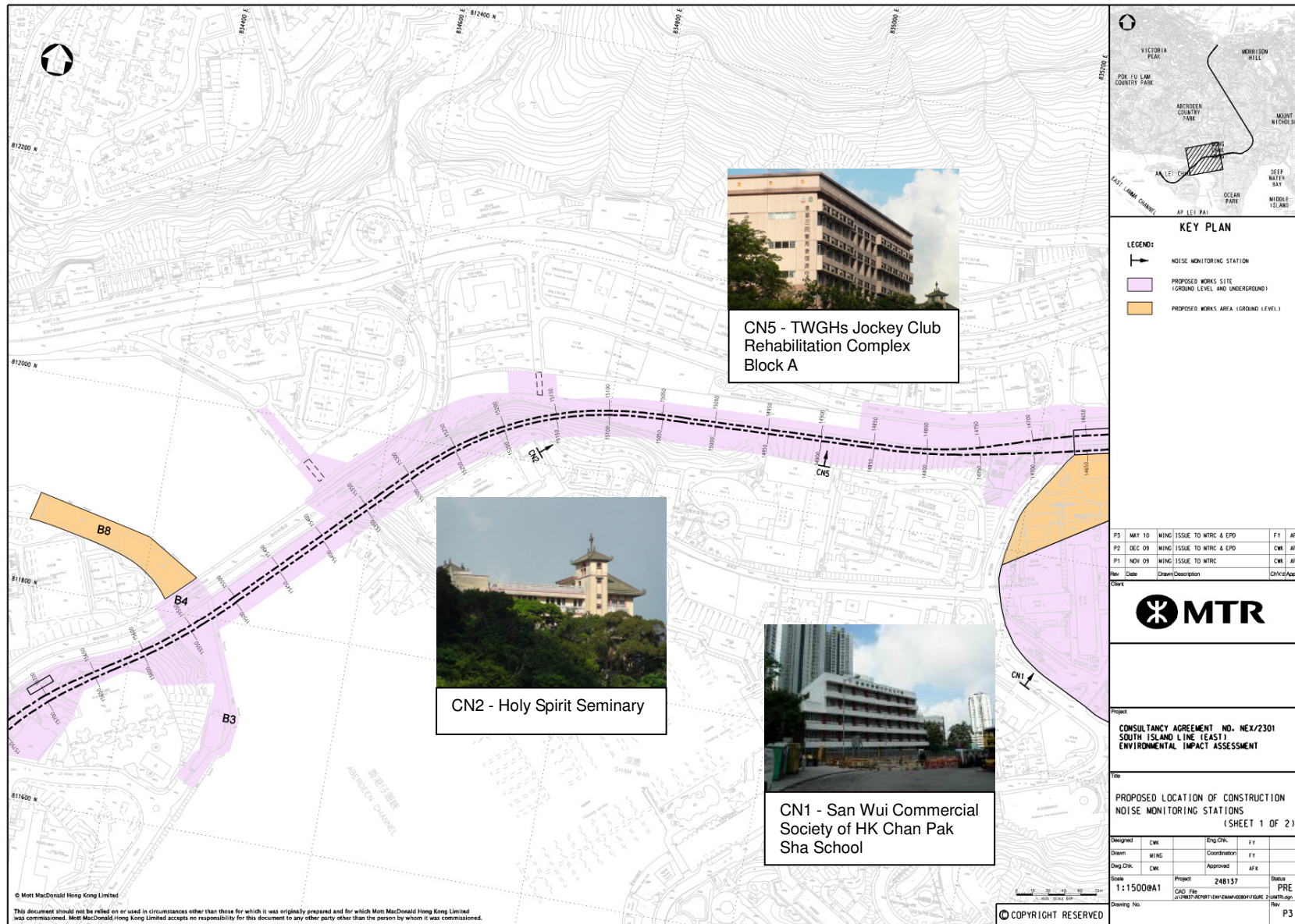

Figure 8 – Location of Construction Noise Monitoring Stations (2 of 2)

