



東業德勤測試顧問有限公司

ETS-TESTCONSULT LIMITED

8/F., Block B, Veristrong Industrial Centre, 34-36 Au Pui Wan Street, Fotan, Hong Kong

Tel : 2695 8318

E-mail : etl@ets-testconsult.com

Fax : 2695 3944

Web site : www.ets-testconsult.com

TEST REPORT

CHINA HARBOUR ENGINEERING CO. LTD.

**DELIVERY OF RECLAMATION MATERIAL TO
MAINLAND –
ENVIRONMENTAL MONITORING AND AUDIT
(CONTRACT NO.: CV/2005/01)**

TUEN MUN AREA 38 FILL BANK

QUARTERLY EM&A SUMMARY REPORT NO.8

(FROM SEPTEMBER TO NOVEMBER 2008)

Prepared by:

LAW, Sau Yee
Senior Environmental Officer

Checked by:

LAU, Chi Leung
Environmental Team Leader

Issue Date: 17 December 2008

Report No.: ENA81291

MATERIALAB CONSULTANTS LIMITED

Fugro Development Centre
5 Lok Yi Street, 17 M.S. Castle Peak Road,
Tai Lam, Tuen Mun, N.T., Hong Kong.

Telephone: +852-24508233
Telefax : +852-24506138
Email : mcl@fugro.com.hk

Materialab**FAX MESSAGE**Priority normal / urgentTo ETS - Testconsult Ltd.Ref. No. MCLF2264

Country _____

Fax No. 2695 3944Attn. Mr C. L. Lau / Ms Linda LawDate 19 December 2008From Joseph PoonNo. of Pages 1 (Incl. this page)C.c. To Mr P. Y. Lu / Mr H. C. Tang (CEDD)Fax No. 2714 0113Mr W. F. Lok / Mr Albus Cheung
(China Harbour Engineering Co. Ltd.)Fax No. 2247 4108

Subject **Agreement No. CE 9/2005 (EP)
Tuen Mun Area 38 Fill Bank -
Quarterly Environmental Monitoring & Audit Report for September - November
2008**

We refer to the 8th Quarterly EM&A Report for September to November 2008 that we received through email on 18th December 2008 and are pleased to confirm we have no further comment on the report.

Should you require further information, please feel free to contact us.

Best regards,



Joseph Poon
Independent Environmental Checker

JP/by

CONFIDENTIALITY NOTICE

This facsimile transmission is intended only for the use of the addressee and is confidential. If you are not the addressee it may be unlawful for you to read, copy, disclose or otherwise use the information in this facsimile. If you are not the intended recipient, please telephone or fax us immediately.

(If you do not receive all pages, please fax response or phone +852-24508233.)



TABLE OF CONTENTS		Page
EXECUTIVE SUMMARY		
1.0	INTRODUCTION	1
2.0	PROJECT INFORMATION	
	2.1 Construction Programme in this reporting quarter	1
	2.2 Project Organization and Management Structure	1
	2.3 Contact Details of Key Personnel	1
3.0	SUMMARY OF EM&A REQUIREMENTS	
	3.1 EM&A Programme	1 – 2
	3.2 Monitoring Stations and Parameters	2
	3.3 Monitoring Methodology and Calibration Details	2
	3.4 Environmental Quality Performance Limits (Action/Limit Levels)	2
	3.5 Environmental Mitigation Measures	2
4.0	MONITORING RESULTS	
	4.1 Air Quality	2
	4.2 Noise	3
	4.3 Marine Water Quality	3
5.0	INSPECTION RESULTS	
	5.1 Inspection Results	4
	5.2 Status of Environmental Licensing and Permitting	4
	5.3 Advice on Solids and Liquid Waste Management Status	4 – 5
6.0	NON-COMPLIANCE OF THE ENVIRONMENTAL QUALITY PERFORMANCE LIMITS	
	6.1 Summary of Non-compliance	5
	6.2 Review of the Reasons for and the implication of non-compliance	5
	6.3 Summary of Action Taken	5
	6.4 Summary of Environmental Complaint, Notification of Summons and Successful	5 – 6
7.0	COMMENTS, CONCLUSIONS AND RECOMMENDATION	6 – 7
APPENDIX		
A	Organization Chart and Lines of Communication	
B	Graphical Plots of Impact Air Quality Monitoring Data	
C	Graphical Plots of Impact Noise Monitoring Data	
D	Graphical Plots of Impact Marine Water Quality Monitoring Data	
E	Environmental Quality Performance (Action / Limit Levels)	
F	Event-Action Plans	
G	Construction Programme	
H	Implementation Schedule of Environmental Mitigation Measures (EMIS)	
I	Statistical Analysis of the Trend of Suspended Solids in the Quarter	
J	Site General Layout Plan	

Figures

- Figure 2 Locations of Air Quality Monitoring Stations – Tuen Mun Area 38 Fill Bank
Figure 3 Locations of Water Quality Monitoring Stations – Tuen Mun Area 38 Fill Bank
Figure 4 Locations of Noise Quality Monitoring Stations – Tuen Mun Area 38 Fill Bank

Tables

- 2.1 Contact Details of Key Personnel
4.1 Summary of Number of Exceedances for 1-hr and 24-hr TSP Monitoring
4.2 Total Number of Marine Water Quality Exceedances in this quarter
4.3 Summary of Statistically Significant Results of SS
5.1 Summary of Environmental Licensing and Permit Status
5.2 Estimated Offsite Waste Disposal in the Reporting Quarter
6.1 Summary of Environmental Complaints and Prosecutions



EXECUTIVE SUMMARY

This is the eighth Quarterly Environmental Monitoring and Audit (EM&A) Summary Report prepared by ETS-Testconsult Ltd (ET) for the "Contract No. CV/2005/01 Delivery of Reclamation Material to Mainland -Tuen Mun Area 38 Fill Bank" (The Project).

This report documents the findings of EM&A Works conducted during the operation phase of Fill Bank at Tuen Mun Area 38 from September to November 2008.

Construction Progress

As informed by the Contractor, the construction activities in this reporting quarter were as below:

- Removal & delivery of public fill stockpiled material to Mainland
- Operation of the road water lorries and the road sweeper
- Maintenance of haul road within fill bank area
- Operation of the Tipping Halls (B1, B2 & B3)
- Operation at the queuing area for public truck lorries

Environmental Monitoring Works

Air Monitoring

During the reporting quarter, no exceedances of Action and Limit levels were recorded for 24-hr and 1-hr TSP monitoring. The air quality during the operation hours of the Fill Bank was considered acceptable.

Marine Water Quality Monitoring

According to the summary of marine water monitoring results, no exceedances of Action and Limit Level were recorded in this quarter.

Noise Monitoring

No exceedances of Action and Limit levels for noise monitoring were recorded in this quarter.

Environmental Complaints, Notification of summons and successful prosecutions

One complaint and no notification of summons and prosecutions with respect to environmental issues were received in this quarter. Details of the complaint are present in clause 6.4.



1.0 INTRODUCTION

China Harbour Engineering Company Limited (CHEC) appointed Environmental Team (ET) of ETS-Testconsult Limited (ETL) to undertake the Environmental Monitoring and Audit (EM&A) for the "Contract No. CV/2005/01 Delivery of Reclamation Material to Mainland – Tuen Mun Area 38 Fill Bank" (The Project).

In accordance with the Condition 5 of Part C of Environmental Permit (No.: EP-210/2005) (the EP), an EM&A programme as set out in the Project Profile should be implemented. The EM&A programme requires environmental monitoring for air quality, water quality and environmental site inspections for air quality, water quality, landscape and visual, and waste management.

Baseline monitoring was completed in May 2003 by Stanger Asia Ltd. Action and Limit Levels were established for air and water quality parameters based on the baseline monitoring results.

This quarterly report documented the findings of EM&A Works conducted during the operation phase of Fill Bank at Tuen Mun Area 38 in September, October and November 2008.

2.0 PROJECT INFORMATION

2.1 Construction Programme in this reporting quarter

Details of construction programme are shown in Appendix G.

2.2 Project Organization and Management Structure

The organization chart and lines of communication with respect to the on-site environmental management and monitoring program are shown in Appendix A.

2.3 Contact Details of Key Personnel

The key personnel contact names and telephone numbers are shown in Table 2.1.

Table 2.1 Contact Details of Key Personnel

Organization	Name of Key Staff	Project Role	Tel. No.	Fax No.
CEDD	Mr. W T CHAU	Engineer's Representative	2760 5835	2714 0113
	Mr. H C TANG			
	Mr. P Y LU			
IEC (Materialab)	Mr Joseph POON	IEC	2450 8238	2450 6138
Contractor (CHEC)	Mr. W. F. LOK	Contractor's Agent	9847 8334	2243 4089
ET (ETL)	Mr. C. L. LAU	ET Leader	2946 7791	2695 3944

3.0 SUMMARY OF EM&A REQUIREMENTS

3.1 EM&A Programme

The EM&A programme required environmental monitoring for air quality, marine water quality and environmental site inspections for air quality, marine water quality, landscape and visual, and waste management. The EM&A requirements for each parameter described in the following sections include:

- All monitoring parameters;
- Monitoring schedules for the reporting month and forthcoming months;
- Action and Limit levels for all environmental parameters;
- Event/Action Plans;
- Environmental mitigation measures, as recommended in the Project EIA study final report; and
- Environmental requirements in contract documents.



The advice on implementation status of environmental protection and pollution control/mitigation measures is summarized in Section 4 of the Report.

3.2 Monitoring Stations and Parameters

The EM&A Manual designates several locations to monitor environmental impacts in terms of air quality, noise and water quality due to the Project. The description and detailed locations of monitoring stations for air quality, noise and marine water quality are shown in Figures 2, 3 and 4 and relevant sections of this Report.

3.3 Monitoring Methodology and Calibration Details

All monitoring works were conducted and monitoring equipment was calibrated in according with the EM&A Manual.

3.4 Environmental Quality Performance Limits (Action/Limit Levels)

The environmental quality performance limits, i.e. Action/Limit Levels (AL Levels) were derived from the baseline monitoring results. If the measured environmental quality parameters exceed the AL Levels, the respective action plan will be implemented. The AL Levels for each monitoring parameter are given in Appendix E. The event action plan is given in Appendix F.

3.5 Environmental Mitigation Measures

Relevant mitigation measures were recommended in the EM&A Manual for the Contractor to implement. A list of mitigation measures is given in Appendix H.

4.0 MONITORING RESULTS

4.1 Air Quality

In accordance with the EM&A Manual, 1-hr and 24-hr TSP air quality monitoring are to be conducted three times and one time per six days correspondingly. In the reporting quarter, all the 1-hr and 24-hr TSP monitoring results complied with the AL Levels. The monitoring trend of air quality during the reporting quarter are given in Appendix B.

Major dust sources in the Fill Bank were dump truck traffic and hauling activities.

Table 4.1 presents the number of exceedances recorded in each month of the reporting quarter. The number of monitoring event included regular monitoring events and additional ones.

Table 4.1 Summary of Number of Exceedances for 1-hr and 24-hr TSP Monitoring

Monitoring Parameter	Level of Exceedance	September 2008	October 2008	November 2008
24-hr TSP	No of monitoring events	6	6	5
	Action Level	0	0	0
	Limit Level	0	0	0
	Total	0	0	0
1-hr TSP	No of monitoring events	16	16	15
	Action Level	0	0	0
	Limit Level	0	0	0
	Total	0	0	0

4.2 Noise

Since Lands Dept did not approve to carry out noise monitoring at their own area where the noise monitoring stations TM-N1 and TM-N2 located due to the security, noise monitoring carried out at two noise monitoring stations TM-RN1 and TM-RN2 (refer to the figure attached) temporarily from 18 December 2007 and before Lands Department's approval.

No exceedances were recorded in this reporting quarter.

4.3 Marine Water Quality

In accordance with the Project Profile, impact marine water quality monitoring was conducted at two control monitoring stations (TM-FC1 and TM-FC2) and two impact monitoring stations (TM-FM1 and TM-FM2) in this quarter.

Impact marine water quality monitoring was conducted three days per week. Measurements were taken at both mid-ebb and mid-flood tides at three depths (i.e. 1m below surface, mid depth and 1m above seabed). The AL Levels are included in Appendix E.

No exceedances of all marine water quality monitoring parameters were recorded in this quarter.

Table 4.2 presents the total number of marine water quality exceedances in the reporting quarter. The trend of marine water quality in the past three months is depicted in Appendix D.

Table 4.2 Total Number of Marine Water Quality Exceedances in this quarter

Parameter	Exceedance Level	September 2008	October 2008	November 2008
Number of monitoring days		13	12	13
Dissolved Oxygen, DO (S&M)	Action	0	0	0
	Limit	0	0	0
	Total	0	0	0
Dissolved Oxygen, DO (B)	Action	0	0	0
	Limit	0	0	0
	Total	0	0	0
Turbidity	Action	0	0	0
	Limit	0	0	0
	Total	0	0	0
Suspended Solids, SS	Action	0	0	0
	Limit	0	0	0
	Total	0	0	0
Total Number of DO, Turbidity and SS Exceedances	Action	0	0	0
	Limit	0	0	0
	Total	0	0	0

A comparison between the quarterly mean/median of SS and the 1.3 times of the baseline mean was made for each tide at each station. The statistical analysis results are given in Appendix I and it shows that the quarterly mean of SS during impact monitoring was found greater than 130% of the baseline mean. Since there is no significant difference between the control and impact monitoring stations in SS level, higher level in SS level is not project related. Monitoring stations with significant difference ($p < 0.05$) is summarized in Table 4.3.

Table 4.3 Summary of Statistically Significant Results of SS

Monitoring Station		Significant difference?	
		Mid-ebb	Mid-flood
Designated Control Station	FC1	√	√
	FC2	√	√
Designated Monitoring Station	FM1	√	√
	FM2	√	√

5.0 INSPECTION RESULTS

5.1 Implementation Status of Environmental Mitigation Measures

ET conducted weekly site inspections to monitor the Contractor's implementation of environmental mitigation measures.

Air quality was the major environmental issue in the reporting quarter. The Contractor generally implemented most of the environmental mitigation measures in the reporting quarter. Dump truck traffic was the major dust source in the Fill Bank. Generally, the Contractor implemented adequate dust mitigation measures in the reporting quarter including dampening of haul roads, water spraying on the truckloads, during loading and unloading of material and for crushing plant, operation of automatic wheel washing facilities, dampening of fill material prior to handling or stockpiling, etc.

The major noise source was dump truck traffic in the Fill Bank. All site equipment and machinery were well maintained and no noise nuisance was observed during operating.

Drainage channels and wastewater treatment facilities were found maintained in good condition for merit function. The Contractor arranged site workers to clean up the silt and mud regularly.

Although there were a few observations regarding improper handling of oil drums and chemical containers, such as lack of drip tray and accumulated of stagnant water in the drip tray, the Contractor rectified most of these problems. Besides, the Contractor should provide tarpaulin sheets before repairing and maintenance works and also carry out proper cleaning activities immediately after such works.

Overall site area was found tidy and clean. The Contractor was reminded to collect and dispose of the general refuse and other C&D waste in a timely manner.

5.2 Status of Environmental Licensing and Permitting

The status of licences and permits is summarized in Table 5.1.

Table 5.1 Summary of environmental licensing and permit status

Description	Permit No.	Valid Period		Section
		From	To	
Amended Environmental Permit	EP-134/2002/F	26/01/06	---	(Valid) <ul style="list-style-type: none"> ▪ Site clearance ▪ Construction of a temporary storm water system ▪ Stockpiling of 6 million m3 of public fill ▪ Setting up two barging points for transporting the stockpiled public fill by barges ▪ Setting up a temporary barging point at the existing Explosive Off-loading Barging Point for the period of May 2004 to December 2004 for transporting the stockpiled public fill by barge ▪ Construction of operation of a construction and Demolition Material Sorting Facility (C&DMSF) ▪ Setting up a Construction and Demolition Material Crushing Facility at the TKO Basin ▪ Remove the temporary fill bank
Chemical Waste Producer	5123-839-C1186-05	04/01/07	---	Spent Lubricating oil / Spent Flammable Liquid / Spent Battery / Surplus Paint
Effluent Discharge License	EP760/421/0121 41/I	19/04/07	30/04/12	Discharge of Industrial Trade Effluent arising from public fill reception facilities

5.3 Advice on Solids and Liquid Waste Management Status

Table 5.2 summarizes data on offsite waste disposal in the quarter.



Table 5.2 Estimated Offsite Waste Disposal in the Reporting Quarter

Waste Type	Examples	September 2008	October 2008	November 2008
C&D Waste	Domestic waste (site) collected in garbage bins and general refuse (m ³)	0	0	0
Chemical Waste	Waste oil (L) / Chemical Waste (kg)	245 kg	0	0

6.0 NON-COMPLIANCE OF THE ENVIRONMENTAL QUALITY PERFORMANCE LIMITS

6.1 Summary of Non-compliance

In this reporting quarter, no exceedances of Action and Limit Level of marine water quality, noise, 24-hr and 1-hr TSP monitoring results were recorded.

6.2 Review of the Reasons for and the Implications of Non-compliance

Since there were no exceedances on noise, marine water quality and air quality monitoring parameters recorded in this monitoring quarter, the review of the reasons for the non-compliance was not required.

6.3 Summary of Actions Taken

Since no exceedances were recorded, no further actions were required.

6.4 Summary of Environmental Complaint, Notifications of Summons and Successful Prosecutions Handling

No complaints, notifications of summons and successful prosecutions were received in this quarter.

A summary of environmental complaints and prosecutions was given in Table 6.1.

Table 6.1 Summary of Environmental Complaints and Prosecutions

Period	Complaints logged	Summon served	Successful Prosecution
September 2008	0	0	0
October 2008	0	0	0
November 2008	0	0	0
Cumulative	1	0	0

7.0 COMMENTS, CONCLUSIONS AND RECOMMENDATION

This report presents the third quarter of the Fill Bank operation. Major activity in the Fill Bank was the import and dumping of fill material. Air quality was the major environmental issue in the Fill Bank. Generally, the Contractor implemented most of the mitigation measures to minimize the dust impact.

No exceedances of Action and Limit Level of air quality, noise and marine water quality monitoring were recorded in this reporting quarter.

The noise level measured at the monitoring station complied with the Limit Level. No complaint was received regarding noise issue in this reporting month.

No complaints, notification of summons and prosecutions with respect to environmental issues were received in this quarter.

According to the ET weekly site inspection and IEC site audits carried out in this quarter, it was indicated that site practices of the Contractor were generally undertaken in an environmentally acceptable manner and the overall site environmental performance was up to standard.

According to the environmental site inspections performed in the reporting quarter, the following recommendations were provided:



Air Quality

- Ensure the frequency of water spraying on haul roads, unloading areas and stockpiles to be sufficient to suppress the dust sources;
- Conduct road sweeping on the public road and the main haul roads outside and near the site egress by the road sweeper;
- Undertake water spraying on stockpiling area;
- Provide proper maintenance for the powered mechanical equipment and barges to avoid emission of dark smoke;
- Provide water spraying onto the truckloads during inspection of fill material;
- Erect adequate speed limit signs to advise the truck drivers of the speed limit;
- Implement the dust mitigation measures for the construction activities; and
- Ensure all vehicles to be washed before leaving the site egress through the provision, operation and maintenance of automatic wheel washing facilities.

Noise

- Conduct noisy activities at a farther location from the NSRs.

Water Quality

- Maintain the drainage system regularly;
- Operate the cleaning vessel regularly; and
- Remove the stagnant water or provide pesticide for the stagnant water in the permanent desilting chambers, if any.

Chemical and Waste Management

- Remove waste materials from the site to avoid accumulation regularly;
- Handle and store chemical wastes properly;
- Remove unwanted material in the existing stockpiles and avoid further dumping of such material;
- Provide and maintain sufficient drip trays for diesel drums, chemical containers, chemical waste storage drums and diesel operated generator set;
- Maintain good housekeeping at the workshop area;
- Ensure sufficient tarpaulin sheets are provided to cover drip trays; and
- Avoid soil being polluted during oil filling and equipment maintenance; hence, properly remove and store the contaminated soil, if any.

Landscape and Visual

- Provide hydroseeding on the exposed slopes, on which the final profile has been formed;
- Erect all the site hoarding/chaining fences in accordance with agreed design at proper location; and
- Maintain the hydroseeding slopes in accordance with the Landscape Plan.



Appendix A

Organization Chart and Lines of Communication

**Contract No. CV/2005/01
Delivery of Reclamation Material to Mainland**

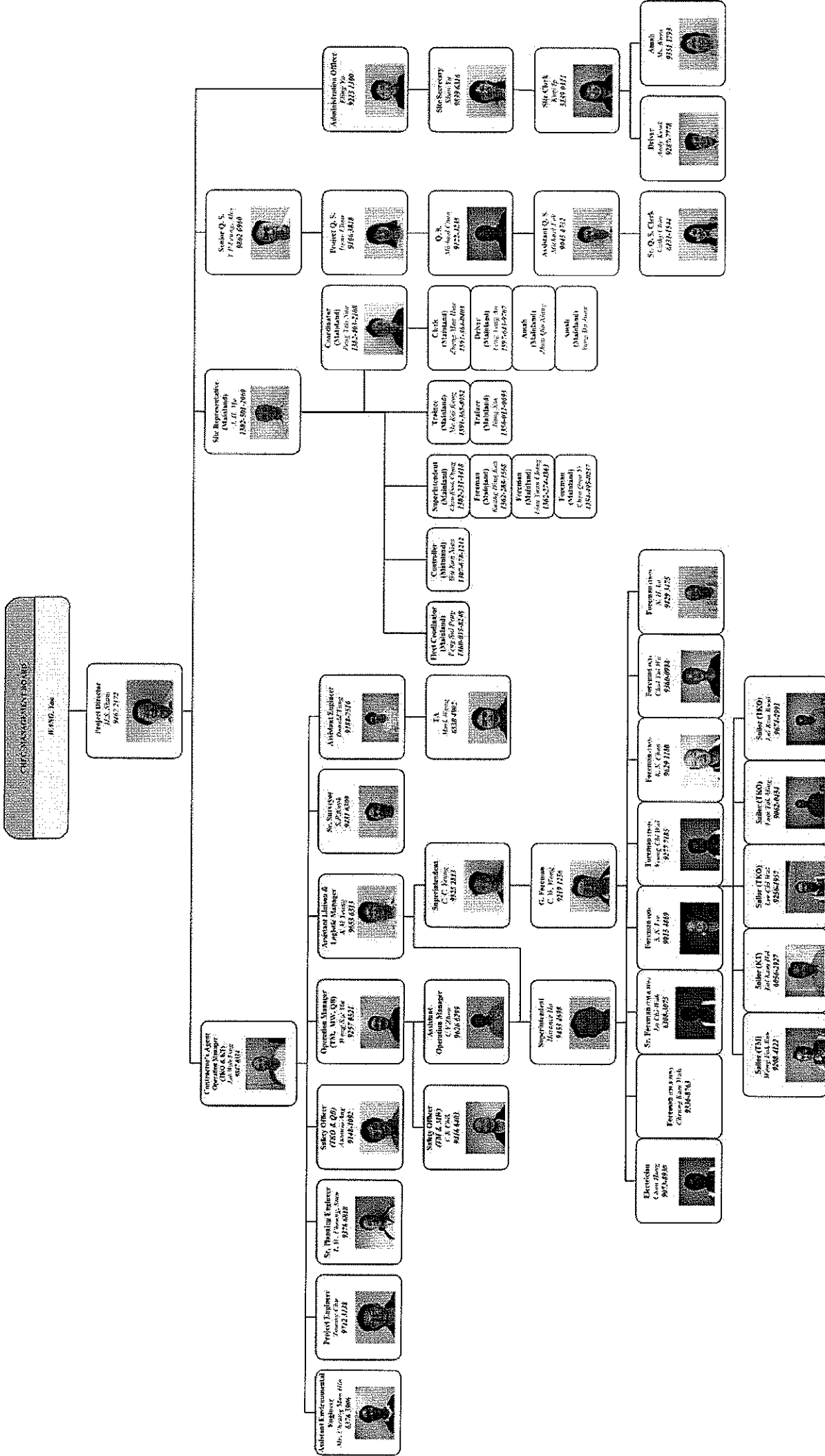

Lines of Communication

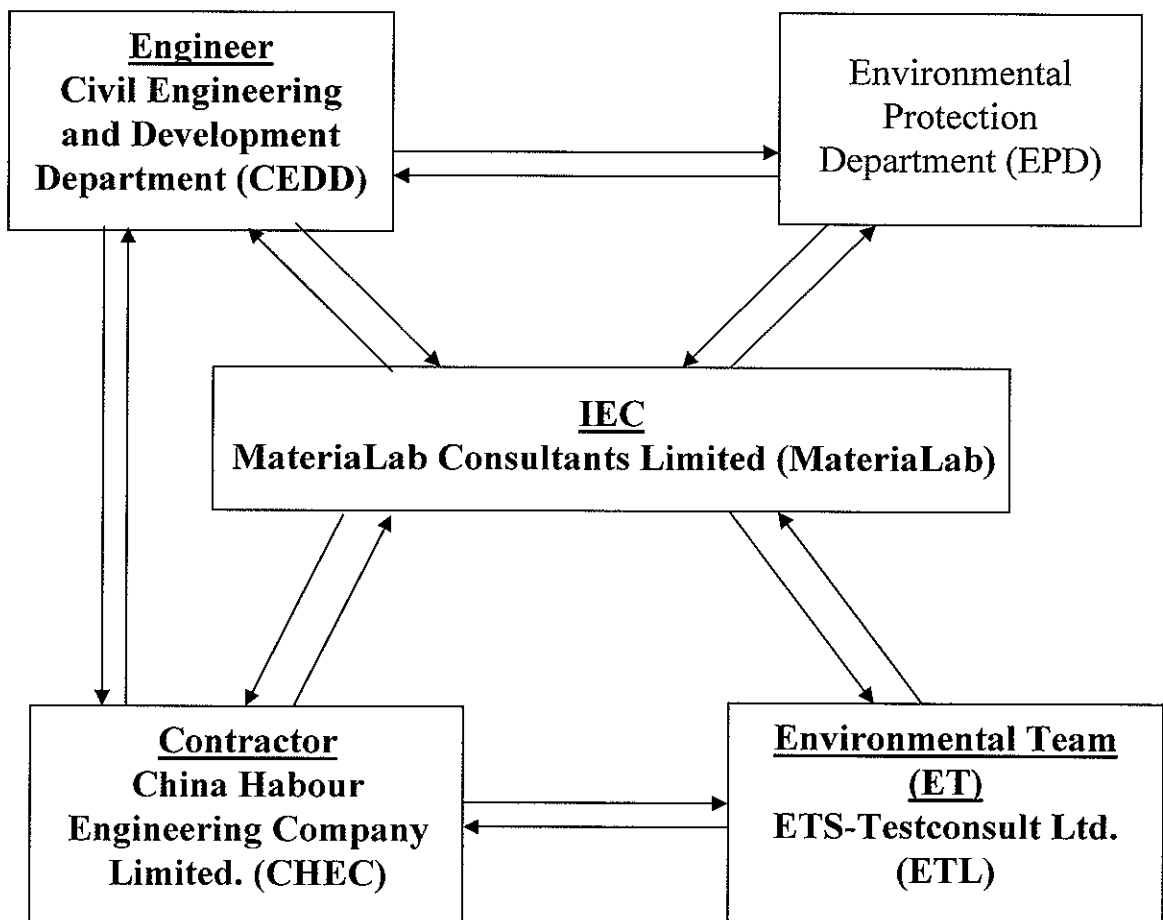



東業德勤測試顧問有限公司
ETS-TESTCONSULT LIMITED

Appendix B

Graphical Plots of Air Quality Monitoring Data



1-hour TSP level at TM-A1

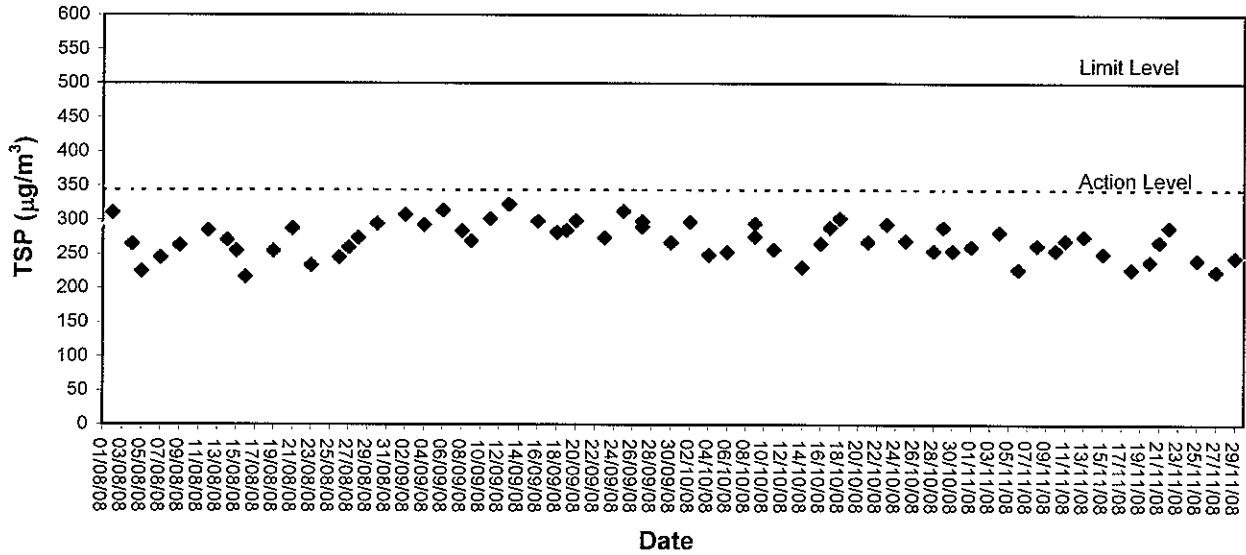

1-hour TSP level at TM-A2

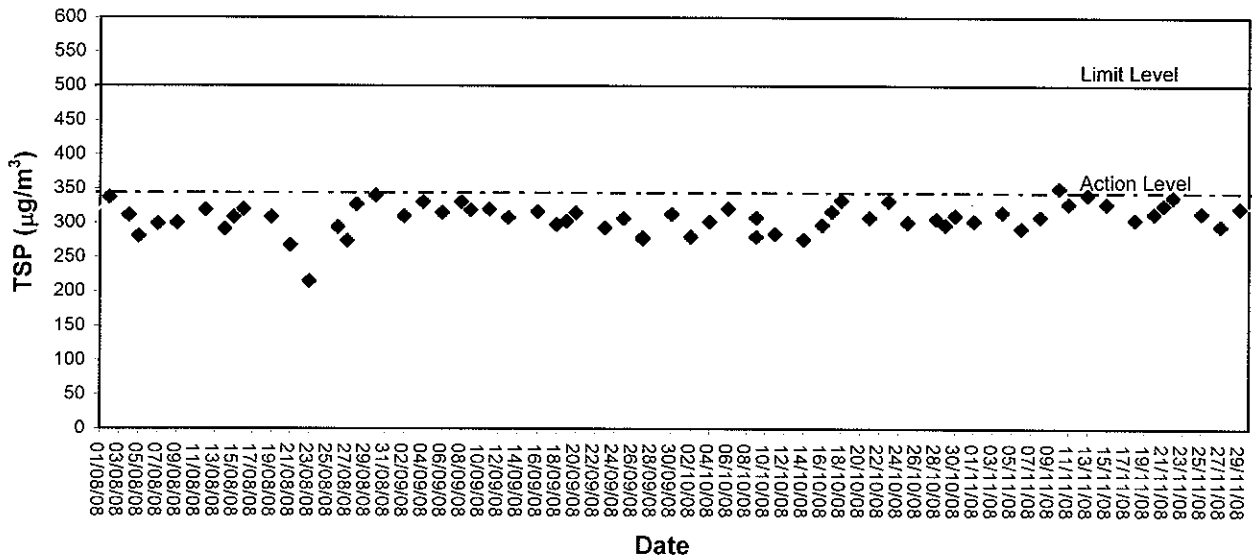



24-hour TSP level at TM-A1

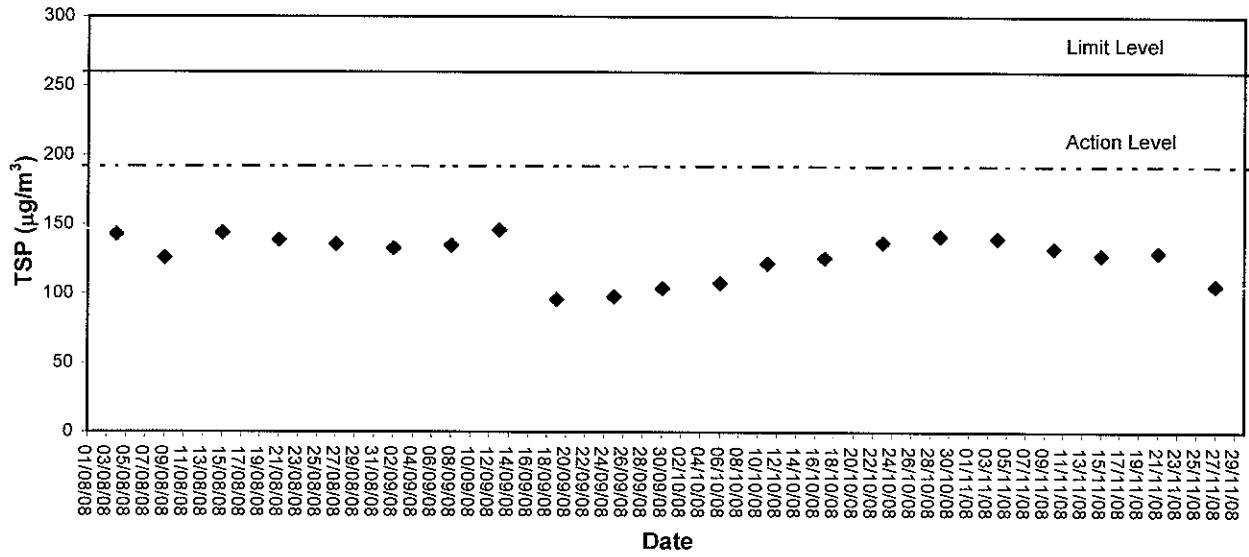

24-hour TSP level at TM-A2

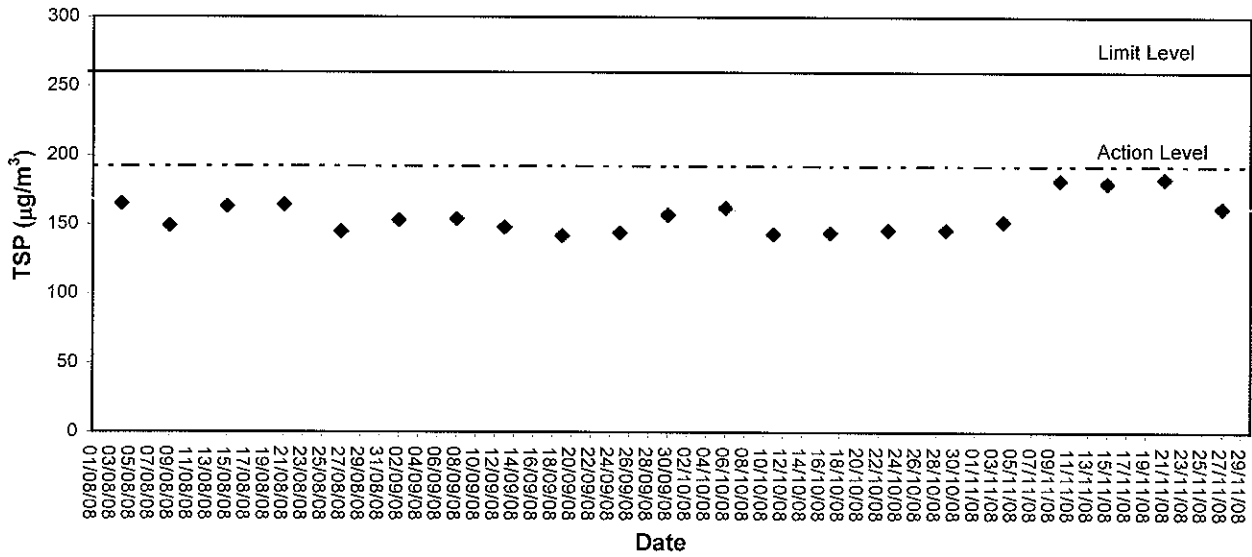



Appendix C

Graphical Plots of Impact Noise Monitoring Data



Noise Monitoring (Day-time)

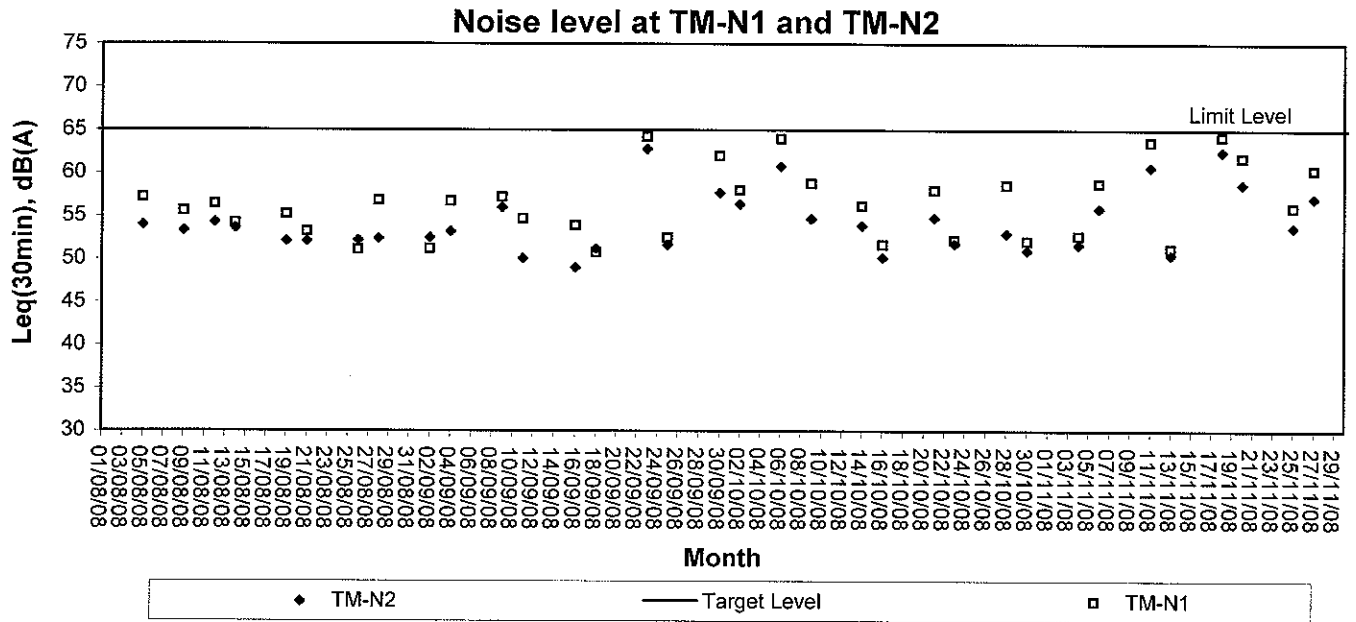



Appendix D

Graphical Plots of Impact Marine Water Quality Monitoring Data



Dissolved Oxygen (Surface & Middle) at Mid-Flood Tide

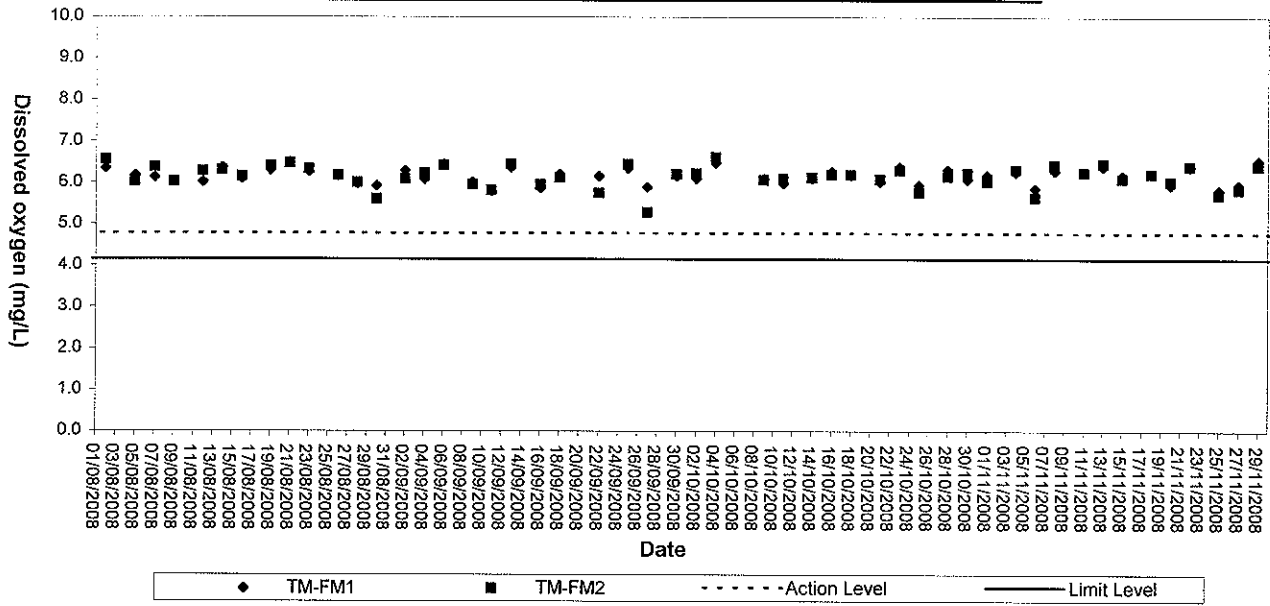

Dissolved Oxygen (Surface & Middle) at Mid-Ebb Tide

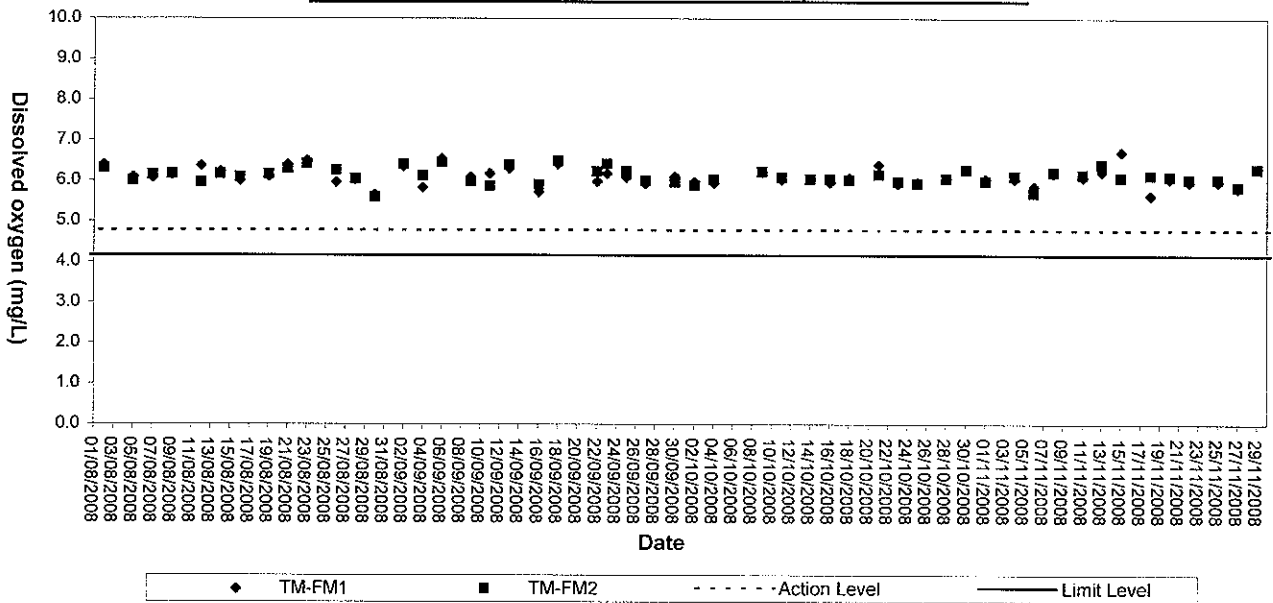



Dissolved Oxygen (Bottom) at Mid-Flood Tide

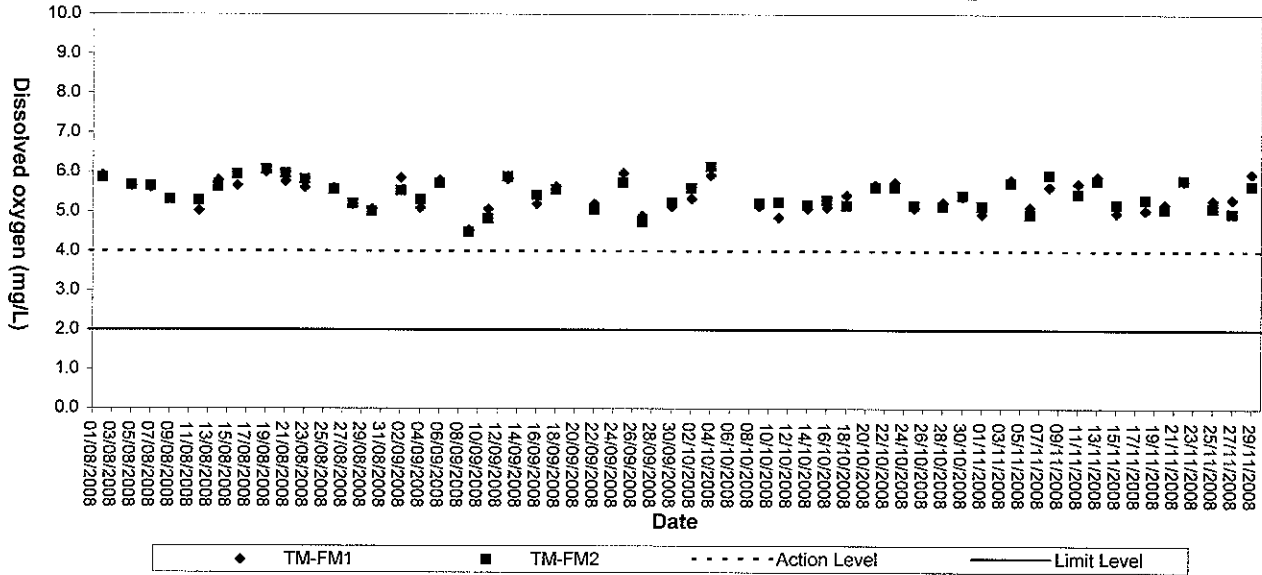

Dissolved Oxygen (Bottom) at Mid-Ebb Tide

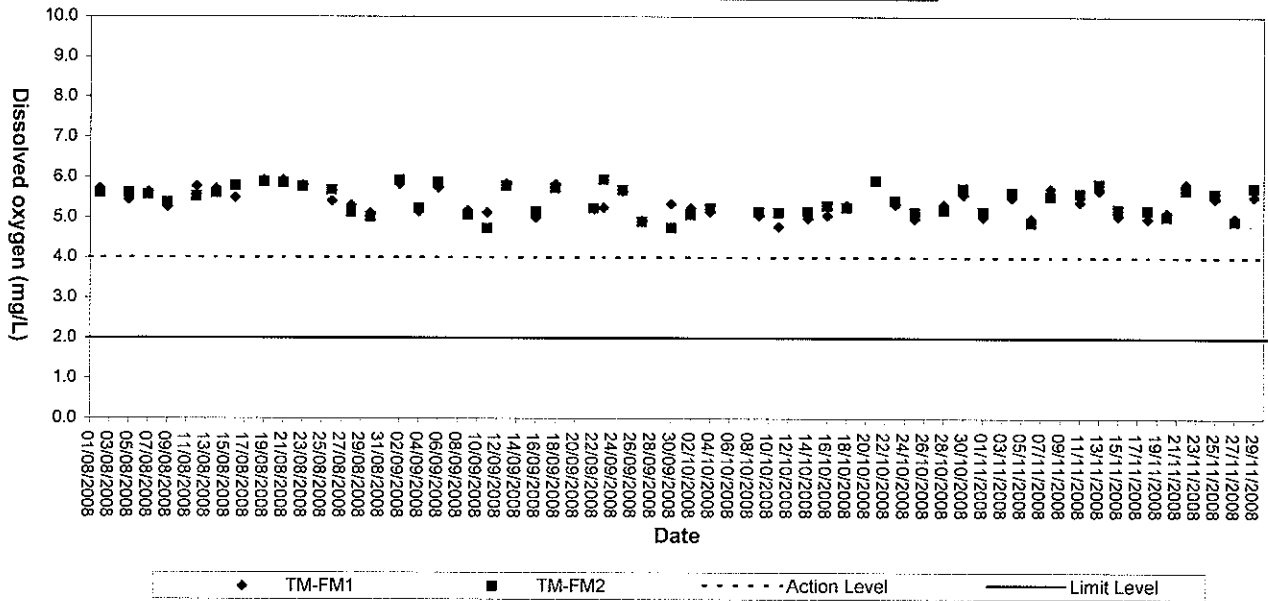



Turbidity (Depth-average) at Mid-Flood Tide

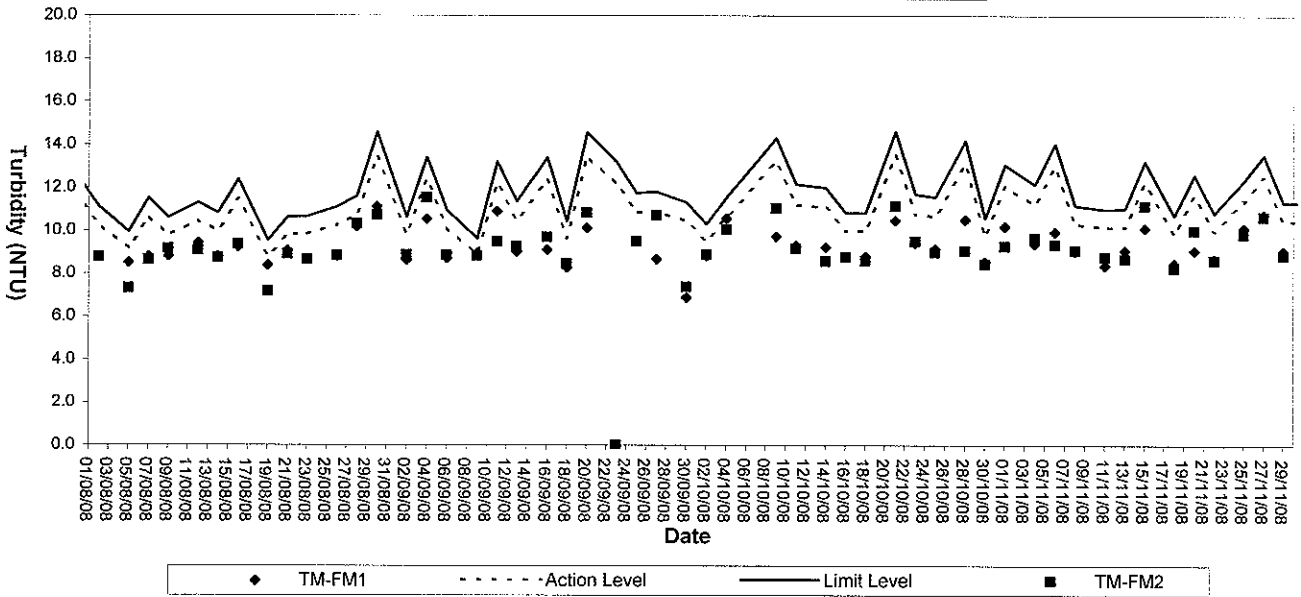

Turbidity (Depth-average) at Mid-Ebb Tide

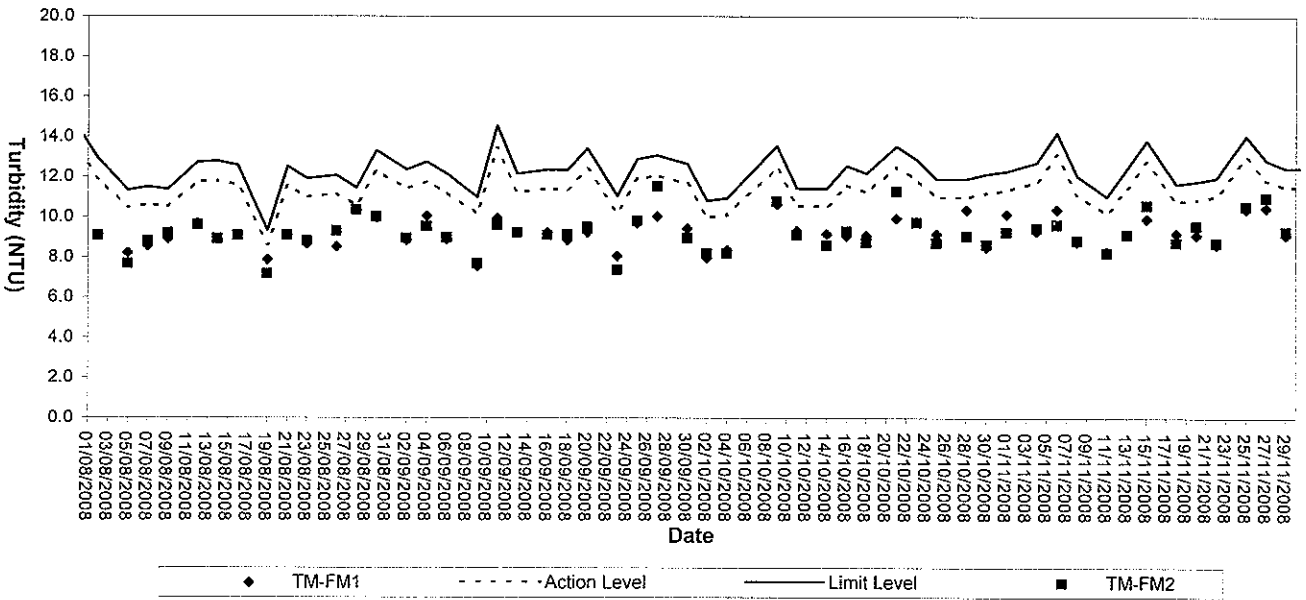



Suspended solids (Depth-average) at Mid-Flood Tide

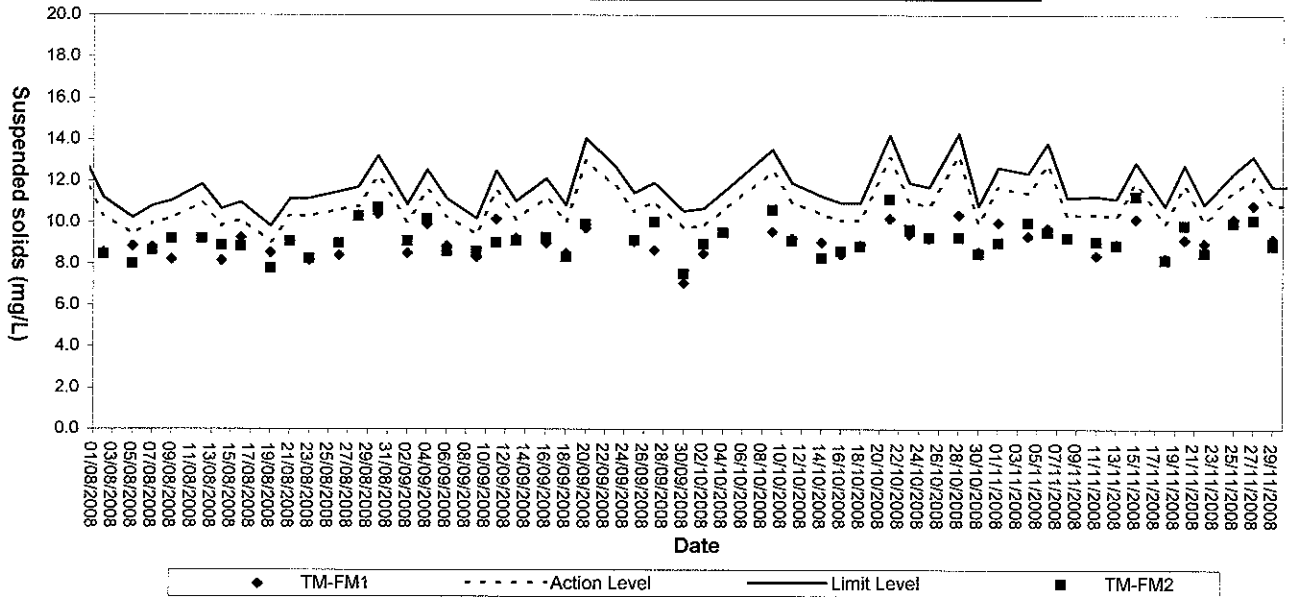

Suspended Solids (Depth-average) at Mid-Ebb Tide

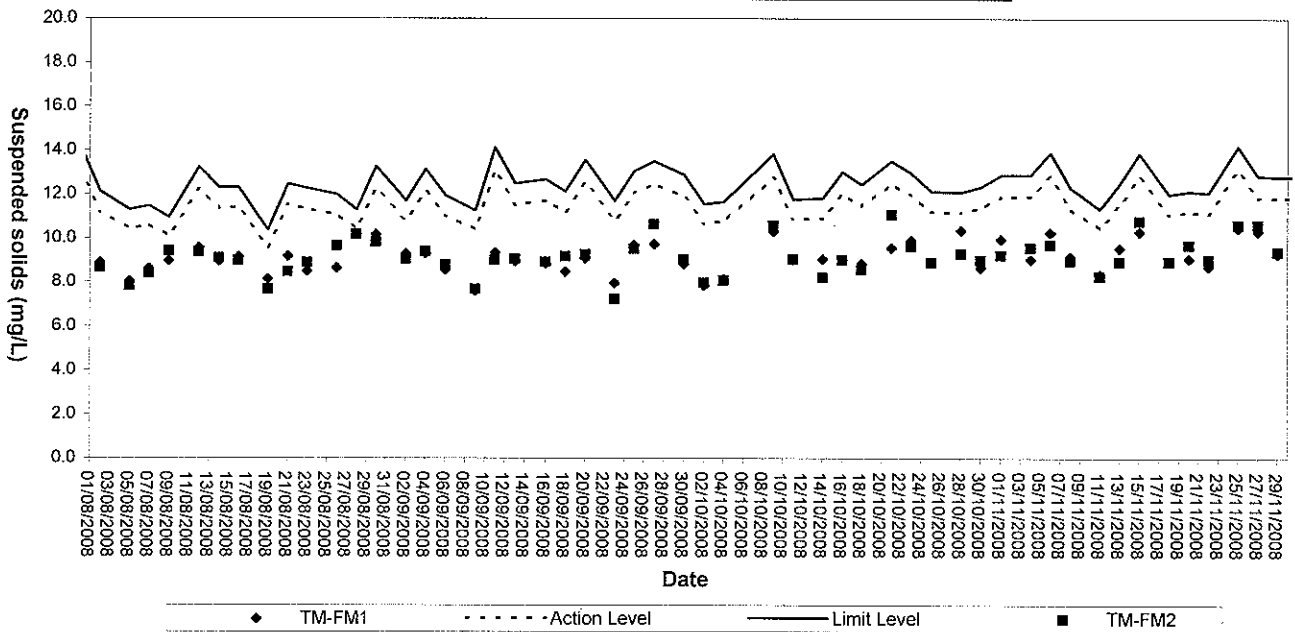



Appendix E

Environmental Quality Performance (Action / Limit Levels)



Action and Limit Levels for 1-hour TSP and 24-hour TSP Monitoring

Monitoring Location	24-hr TSP ($\mu\text{g}/\text{m}^3$)		1-hr TSP ($\mu\text{g}/\text{m}^3$)	
	Action Level	Limit Level	Action Level	Limit Level
TM-A1	192	260	344	500
TM-A2	192	260	344	500

Action and Limit Levels for Marine Water Quality Monitoring

Parameter	Action Level	Limit Level
DO (mg/L)	<u>Surface & Middle</u> <4.78 mg/L (5%-ile of baseline data) <u>Bottom</u> <4.16 mg/L (5%-ile of baseline data)	<u>Surface & Middle</u> <4.00 mg/L (1%-ile of baseline data) <u>Bottom</u> <2.00 mg/L
SS (mg/L) (Depth-averaged)	>120% of the upstream control station's SS at the same tide on the same day	>130% of the upstream control station's SS at the same tide on the same day
Turbidity (NTU) (Depth-averaged)	>120% of the upstream control station's turbidity at the same tide on the same day	>130% of the upstream control station's turbidity at the same tide on the same day

Action and Limit Levels for Noise Monitoring

Time Period	Action *	Limit *
0700-1900 hrs on normal weekdays	When one documented complaint is received	65 dB(A)

Remark (*): The Action and Limit Levels refer to the Table 26.2 – Action and Limit Levels for Noise in the Particular Specification of Contract No.CV/2005/01.



Appendix F

Event-Action Plans

EVENT/ACTION PLAN FOR AIR QUALITY EXCEEDANCE

ACTION

	ET Leader	IC(E)	ER	Contractor
ACTION LEVEL				
1. Exceedance for one sample	<ol style="list-style-type: none"> 1. Identify source, investigate the causes of exceedance and propose remedial measures 2. Inform ER, IC(E) and Contractor 3. Repeat measurement to confirm finding 4. Increase monitoring frequency to daily 	<ol style="list-style-type: none"> 1. Check monitoring data submitted by the ET 2. Check contractor's working method 	<ol style="list-style-type: none"> 1. Notify Contractor 	<ol style="list-style-type: none"> 1. Rectify any unacceptable practise 2. Amend working methods if appropriate
2. Exceedance for two or more consecutive samples	<ol style="list-style-type: none"> 1. Identify source, investigate the causes of exceedance and propose remedial measures 2. Inform IC(E) and Contractor 3. Repeat measurements to confirm finding 4. Increase monitoring frequency to daily 5. Discuss with IC(E) and Contractor on remedial actions 6. If exceedance continues, arrange meeting with IC(E) and ER. 7. If exceedance stops, cease additional monitoring 	<ol style="list-style-type: none"> 1. Check monitoring data submitted by the ET 2. Check Contractor's working method 3. Discuss with ET and Contractor on possible remedial measures 4. Advise the ER on the effectiveness of the proposed remedial measures 5. Supervise implementation of remedial measures 	<ol style="list-style-type: none"> 1. Confirm receipt of notification of failure in writing 2. Notify the Contractor 3. Ensure remedial measures properly implemented 	<ol style="list-style-type: none"> 1. Submit proposals for remedial actions to IC(E) within 3 working days of notification 2. Implement the agreed proposals 3. Amend proposal if appropriate
LIMIT LEVEL				
1. Exceedance for one sample	<ol style="list-style-type: none"> 1. Identify source, investigate the causes of exceedance and propose remedial measures 2. Inform ER, Contractor and EPD 3. Repeat measurement to confirm finding 4. Increase monitoring frequency to daily 5. Assess the effectiveness of Contractor's remedial actions and keep IC(E), EPD and ER informed of the results 	<ol style="list-style-type: none"> 1. Check monitoring data submitted by the ET 2. Check Contractor's working method 3. Discuss with ET and Contractor on possible remedial measures 4. Advise the ER on the effectiveness of the proposed remedial measures 5. Supervise implementation of remedial measures 	<ol style="list-style-type: none"> 1. Confirm receipt of notification of failure in writing 2. Notify the Contractor 3. Ensure remedial measures properly implemented 	<ol style="list-style-type: none"> 1. Take immediate action to avoid further exceedance 2. Submit proposals for remedial actions to IC(E) within 3 working days of notification 3. Implement the agreed proposals 4. Amend proposal if appropriate.

EVENT/ACTION PLAN FOR AIR QUALITY EXCEEDANCE

EVENT	ACTION			Contractor
	ET Leader	IC(E)	ER	
2. Exceedance for two or more consecutive samples	<ol style="list-style-type: none"> 1. Identify source, investigate the causes of exceedance and propose remedial measures 2. Notify IC(E), ER, EPD and Contractor 3. Repeat measurement to confirm finding 4. Increase monitoring frequency to daily 5. Carry out analysis of contractor's working procedures to determine possible mitigation to be implemented 6. Arrange meeting with IC(E) and ER to discuss the remedial actions to be taken 7. Assess effectiveness of Contractor's remedial actions and keep IC(E), EPD and ER informed of the results 8. If exceedance stops, cease additional monitoring 	<ol style="list-style-type: none"> 1. Discuss amongst ER, ET and Contractor on the potential remedial actions 2. Review Contractor's remedial actions whenever necessary to assure their effectiveness and advise the ER accordingly 3. Supervise the implementation of remedial measures 	<ol style="list-style-type: none"> 1. Confirm receipt of notification of failure in writing 2. Notify Contractor 3. In consultation with the Contractor on agree with the Contractor on the remedial measures to be implemented 4. Ensure remedial measures are properly implemented 5. If exceedances continues, consider what portion of the work is responsible and instruct the Contractor to stop that portion of work until the exceedance is abated 	<ol style="list-style-type: none"> 1. Take immediate action to avoid further exceedances 2. Submit proposals for remedial actions to IC(E) within 3 working days of notification 3. Implement the agreed proposals 4. Resubmit proposals if problem still not under control 5. Stop the relevant activity of works as determined by the ER until the exceedance is abated

EVENT/ACTION PLAN FOR NOISE EXCEEDANCE

EVENT	ACTION			Contractor
	ET Leader	IC(E)	ER	
Action Level	<ol style="list-style-type: none"> 1. Notify the IC(E) and the Contractor. Carry out investigation. 2. Report the results of investigation to the IC(E) and the Contractor. 3. Discuss with the Contractor and formulate remedial measures. 4. Increase monitoring frequency to check mitigation effectiveness 	<ol style="list-style-type: none"> 1. Review the analysed results submitted by the ET. 2. Review the proposed remedial measures by the Contractor and advise the ER accordingly. 3. Supervise the implementation of remedial measures. 	<ol style="list-style-type: none"> 1. Confirm receipt of notification of failure in writing. 2. Notify the Contractor. 3. Require the Contractor to propose remedial measures for the analysed noise problem. 4. Ensure remedial measures are properly implemented. 	<ol style="list-style-type: none"> 1. Submit noise mitigation proposals to IC(E). 2. Implement noise mitigation proposals.
Limit Level	<ol style="list-style-type: none"> 1. Notify the IC(E), the ER, the EPD and the Contractor. 2. Identify source. 3. Repeat measurement to confirm findings. 4. Increase monitoring frequency. 5. Carry out analysis of Contractor's working procedures to determine possible mitigation to be implemented. 6. Inform the IC(E), the ER and the EPD the causes & actions taken for the exceedances. 7. Assess effectiveness of Contractor's remedial actions and keep the IC(E), the EPD and the ER informed of the results 8. If exceedance due to the construction works stops, cease additional monitoring 	<ol style="list-style-type: none"> 1. Discuss amongst the ER, the ET Leader and the Contractor on the potential remedial actions. 2. Review the Contractor's remedial actions whenever necessary to assure their effectiveness and advise the ER accordingly. 3. Supervise the implementation of remedial measures. 	<ol style="list-style-type: none"> 1. Confirm receipt of notification of failure in writing. 2. Notify the Contractor. 3. Require the Contractor to propose remedial measures for the analysed noise problem. 4. Ensure remedial measures are properly implemented. 5. If exceedances continue, consider what activity of the work is responsible and instruct the Contractor to stop that activity of work until the exceedances is abated. 	<ol style="list-style-type: none"> 1. Take immediate action to avoid further exceedance 2. Submit proposals for remedial actions to IC(E) within 3 working days of notification. 3. Implement the agreed proposals. 4. Resubmit proposals if problem still not under control. 5. Stop the relevant activity of works as determined by the ER until the exceedances is abated.

EVENT AND ACTION PLAN FOR WATER QUALITY EXCEEDANCE

Event	ACTION			IEC
	ET Leader	Contractor	ER	
<p>Action level being exceeded by one sampling day</p>	<ol style="list-style-type: none"> 1. Identify source(s) of impact; 2. Repeat in-situ measurement to confirm findings; 3. Notify Contractor in writing within 24 hours of identification of the exceedance 4. Check monitoring data, all plant, equipment and Contractor's working methods; 5. Carry out investigation to the Contractor within 3 working days of identification of exceedance and advise contractor if exceedance is due to contractor's construction works 7. Discuss mitigation measures with Contractor if exceedance is due to the construction works within 4 working days 8. Repeat measurement on next day of exceedance if exceedance is due to the construction works 	<ol style="list-style-type: none"> 1. Notify the ER and IEC in writing within 24 hours of identification of exceedance 2. Rectify unacceptable practice; 3. Check all plant and equipment; 4. Submit investigation report to IEC and ER within 3 working days of the identification of an exceedance 5. Consider changes of working method if exceedance is due to the construction works 6. Discuss with ET, IEC and ER and propose mitigation measures to IEC and ER if exceedance is due to the construction works within 4 working days of identification of an exceedance 7. Implement the agreed mitigation measures within reasonable time scale 	<ol style="list-style-type: none"> 1. Notify EPD and other relevant governmental agencies in writing within 24 hours of the identification of the exceedance 2. Discuss with IEC, ET and Contractor on the proposed mitigation measures; 3. Require contractor to propose remedial measures for the analysed problem if related to the construction works 4. Ensure remedial measures are properly implemented 5. Assess the effectiveness of the mitigation measure 	<ol style="list-style-type: none"> 1. Check monitoring data submitted by ET 2. Confirm ET assessment if exceedance is due / not due to the works 3. Discuss with ET, ER and Contractor on the mitigation measures 4. Review contractor's mitigation measures whenever necessary to ensure their effectiveness and advise the ER accordingly 5. Supervise the implementation of mitigation measures

EVENT AND ACTION PLAN FOR WATER QUALITY

Event	ACTION			
	ET Leader	Contractor	ER	IEC
<p>Action level being exceeded by more than one consecutive sampling days</p>	<ol style="list-style-type: none"> 1. Identify source(s) of impact; 2. Repeat in-situ measurement to confirm findings 3. Notify Contractor in writing within 24 hours of identification 4. Check monitoring data, all plant, equipment and Contractor's working methods; 5. Carry out investigation 6. Report the results of investigation to the Contractor within 3 working days of identification of exceedance and advise contractor if exceedance is due to contractor's construction works 7. Discuss mitigation measures with IEC and Contractor within 4 working of identification of an exceedance 8. Ensure mitigation measures are implemented; 9. Prepare to increase the monitoring frequency to daily; 10. Repeat measurement on next day of exceedance. 	<ol style="list-style-type: none"> 1. Notify IEC and ER in writing within 24 hours of identification of exceedance 2. Rectify unacceptable practice; 3. Check all plant and equipment; 4. Consider changes of working methods; 5. Submit the results of the investigation to IEC and ER within 3 working days of the identification of an exceedance 6. Discuss with ET, IEC and ER and propose mitigation measures to IEC and ER within 4 working days of identification of an exceedance 7. Implement the agreed mitigation measures within reasonable time scale 	<ol style="list-style-type: none"> 1. Notify EPD and other relevant governmental agencies in writing within 24 hours of the identification of the exceedance 2. Discuss with IEC, ET and Contractor on the proposed mitigation measures; 3. Require contractor to propose remedial measures for the analysed problem if related to the construction works 4. Ensure remedial measures are properly implemented 5. Assess the effectiveness of the mitigation measure 	<ol style="list-style-type: none"> 1. Check monitoring data submitted by ET 2. Confirm ET assessment if exceedance is due / not due to the works 3. Discuss with ET, ER and Contractor on the mitigation measures. 4. Review contractor's mitigation measures whenever necessary to ensure their effectiveness and advise the ER accordingly 5. Assess the effectiveness of the implemented mitigation measures.

EVENT AND ACTION PLAN FOR WATER QUALITY EXCEEDANCE

Event	ACTION			
	ET Leader	Contractor	ER	IEC
Limit level being exceeded by one sampling day	<ol style="list-style-type: none"> 1. Repeat in-situ measurement to confirm findings; 2. Identify source(s) of impact; 3. Notify Contractor in writing within 24 hours of identification of the exceedance 4. Check monitoring data, all plant, equipment and Contractor's working methods; 5. Carry out investigation 6. Report the results of investigation to the Contractor within 3 working days of identification of exceedance and advise contractor if exceedance is due to contractor's construction works 7. Discuss mitigation measures with IEC, ER and Contractor within 4 working of identification of an exceedance 8. Ensure mitigation measures are implemented; 9. Increase the monitoring frequency to daily until no exceedance of Limit Level. 	<ol style="list-style-type: none"> 1. Notify IEC and ER in writing; within 24 hours of the identification of the exceedance 2. Rectify unacceptable practice; 3. Check all plant and equipment; 4. Consider changes of working methods; 5. Submit the results of the investigation to IEC and ER within 3 working days of the identification of an exceedance 6. Discuss with ET, IEC and ER and propose mitigation measures to IEC and ER within 4 working days of the identification of an exceedance 7. Implement the agreed mitigation measures within reasonable time scale 	<ol style="list-style-type: none"> 1. Notify EPD and other relevant governmental agencies in writing within 24 hours of identification of exceedance 2. Discuss with IEC, ET and Contractor on the proposed mitigation measures; 3. Request Contractor to critically review the working methods; 4. Ensure remedial measures are properly implemented 5. Assess the effectiveness of the implemented mitigation measures. 	<ol style="list-style-type: none"> 1. Check monitoring data submitted by ET 2. Confirm ET assessment if exceedance is due / not due to the works 3. Discuss with ET, ER and Contractor on the mitigation measures. 4. Review proposals on mitigation measures submitted by Contractor and advise the ER accordingly. 5. Assess the effectiveness of the implemented mitigation measures

EVENT AND ACTION PLAN FOR WATER QUALITY EXCEEDANCE

Event	ACTION		
	ET Leader	Contractor	ER
Limit Level being exceeded by more than one consecutive sampling days	<ol style="list-style-type: none"> 1. Repeat in-situ measurement to confirm findings; 2. Identify source(s) of impact; 3. Notify Contractor in writing within 24 hours of identification of the exceedance 4. Check monitoring data, all plant, equipment and Contractor's working methods; 5. Carry out investigation 6. Report the results of investigation to the Contractor within 3 working days of identification of exceedance and advise contractor if exceedance is due to contractor's construction works 7. Discuss mitigation measures with IEC, ER and Contractor; 8. Ensure mitigation measures are implemented; 9. Increase the monitoring frequency to daily until no exceedance of Limit Level for two consecutive days. 	<ol style="list-style-type: none"> 1. Notify ER and IEC in writing within 24 hours of the identification of the exceedance and Rectify unacceptable practice; 2. Check all plant and equipment; 3. Consider changes of working methods; 8. Submit the results of the investigation to IEC and ER within 3 working days of the identification of an exceedance 5. Discuss with ET, IEC and ER and propose mitigation measures to IEC and ER within 4 working days; 6. Implement the agreed mitigation measures within reasonable time scale 7. As directed by the Engineer, to slow down or to stop all or part of the marine work or construction activities. 	<ol style="list-style-type: none"> 1. Notify EPD and other relevant governmental agencies in writing within 24 hours of identification of exceedance 2. Discuss with IEC, ET and Contractor on the proposed mitigation measures; 3. Request Contractor to critically review the working methods; 6. Ensure remedial measures are properly implemented 4. Assess the effectiveness of the implemented mitigation measures; 5. Consider and instruct, if necessary, the Contractor to slow down or to stop all or part of the marine work until no exceedance of Limit Level.
			<ol style="list-style-type: none"> 1. Check monitoring data submitted by ET 2. Confirm ET assessment if exceedance is due / not due to the works 3. Discuss with ER, ET and Contractor on the mitigation measures. 4. Review proposals on mitigation measures submitted by Contractor and advise the ER accordingly. 5. Assess the effectiveness of the implemented mitigation measures.

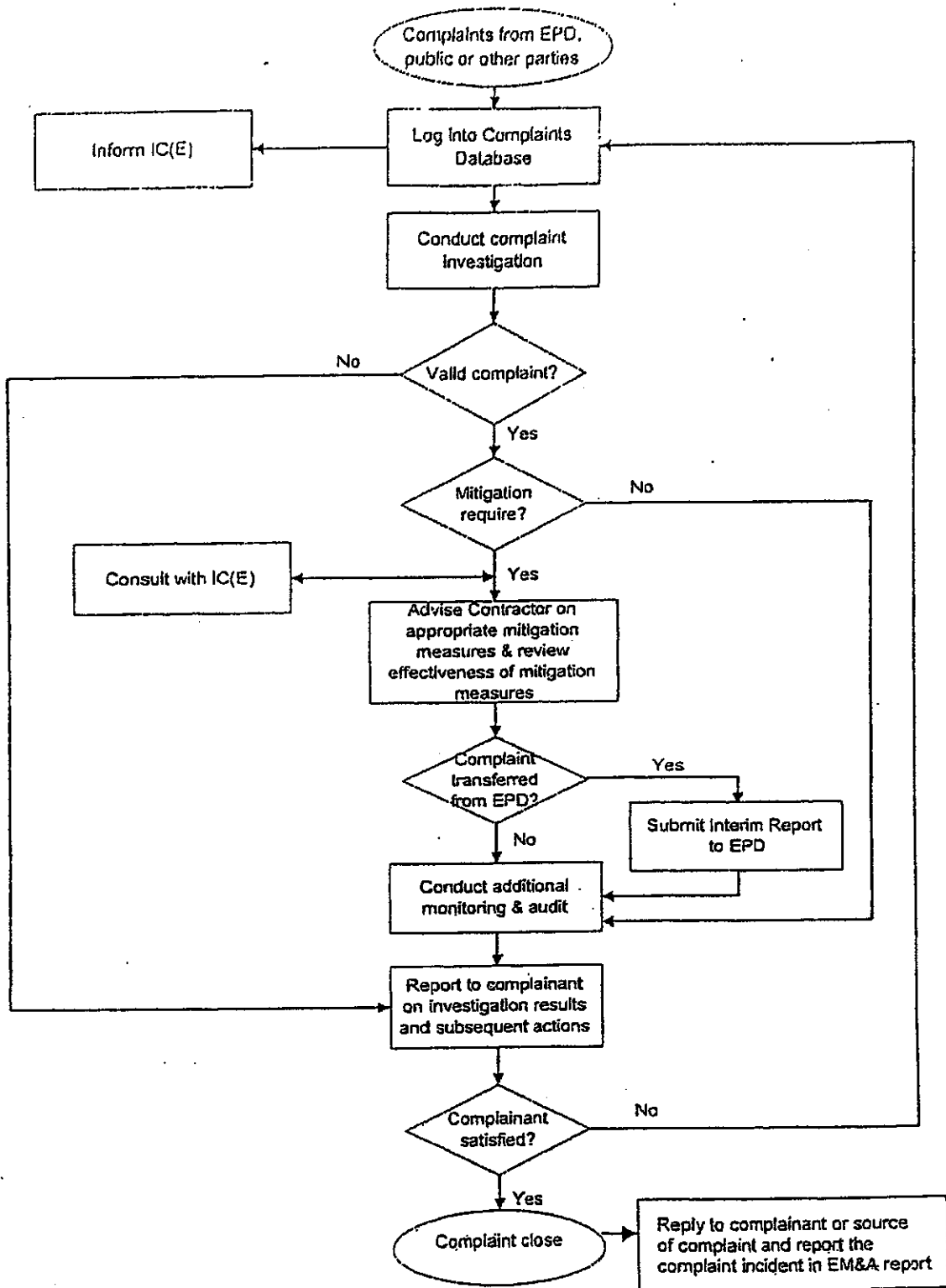

CEDD Contract No. CV/2005/01 Delivery of Reclamation Material to Mainland

Figure 5 Environmental Complaint Handling Procedure - Tuen Mun Area 38 Fill Bank

Scale : ---

Date issued :
December 2006



東業德勤測試顧問有限公司
ETS-TESTCONSULT LIMITED



Appendix G

Construction Programme

Project Activities at TM (From September to December 2008)

Activity ID	Activity description	Original duration	Remaining duration	Percent complete	Early start	Early finish	Late start	Late finish	Total float
EOB1A200	B1a Servicing 24mths	731	100	86	01/12/06A	30/11/2008	01/12/06A	30/11/2008	0
EOB1A300	Measurement System O&M for B1a 104wks	728	97	87	01/12/06A	27/11/2008	01/12/06A	30/11/2008	3
EOB1B200	B1b Servicing 24mths	731	100	86	01/12/06A	30/11/2008	01/12/06A	30/11/2008	0
EOB1B300	Measurement System O&M for B1b 104wks	728	97	87	01/12/06A	27/11/2008	01/12/06A	30/11/2008	3
EOB1B400	Surveillance System O&M for B1b 104wks	728	97	87	01/12/06A	27/11/2008	01/12/06A	30/11/2008	3
EOB1C200	B1c Servicing 24mths	731	100	86	01/12/06A	30/11/2008	01/12/06A	30/11/2008	0
EOB1C300	Measurement System O&M for B1c 104wks	728	97	87	02/12/06A	27/11/2008	02/12/06A	30/11/2008	3
HK050200	Sorting of Stockpiled Public fill	731	100	86	01/12/06A	30/11/2008	01/12/06A	30/11/2008	0
HK050300	Removal of Stockpiled Public Fill (Contractor's	731	100	86	01/12/06A	30/11/2008	01/12/06A	30/11/2008	0
HK050400	Removal of Stockpiled Public Fill (other)	731	100	86	01/12/06A	30/11/2008	01/12/06A	30/11/2008	0
HK050500	Disposal of unsuitable Material	731	100	86	01/12/06A	30/11/2008	01/12/06A	30/11/2008	0
HK050600	Compaction of Public Fill	731	100	86	01/12/06A	30/11/2008	01/12/06A	30/11/2008	0
HK100100	Catchpits TM Area 3mrs	30	30	0	02/10/08*	06/11/2008	27/10/2008	29/11/2008	20
HK100200	Drainage 300mm U-channels TM Area 1000m	50	50	0	02/10/08*	29/11/2008	02/10/2008	29/11/2008	0
HK110300	TM Tipping Halls Operation 308nr-wks	731	100	86	01/12/06A	30/11/2008	01/12/06A	30/11/2008	0
KD0C1000	Achievement of Stage C1 (555days) Contract	0	0	0		22/08/2008		02/07/2008	-51
RHB20200	Record House B2 Servicing 24mths	731	100	86	01/12/06A	30/11/2008	01/12/06A	30/01/2009	61
SOB10200	RE Secondary Office Servicing (B6) 24mths	731	100	86	01/12/06A	30/11/2008	01/12/06A	30/11/2008	0
TACB0200	Servicing 24mths	731	100	86	01/12/06A	30/11/2008	01/12/06A	30/11/2008	0



Appendix H
Implementation Schedule of Environmental Mitigation
Measures (EMIS)



Environmental Mitigation Implementation Schedule

Environmental Protection Measures		Location	Implementation Status			
Air Quality			Implemented	Partially implemented	Not implemented	Not Applicable
<ul style="list-style-type: none"> ▪ Dust control / mitigation measures shall be provided to prevent dust nuisance. ▪ Water sprays shall be provided and used to dampen materials. ▪ All stockpile of aggregate or spoil should be enclosed or covered and water applied in dry or windy condition. ▪ Any vehicle with open load carrying area used for moving materials which has the potential to create dust shall have properly fitting side and tail boards. Material having the potential to create dust shall not be loaded to a level higher than the side and tail boards, and shall be covered by a clean tarpaulin. ▪ Unpaved areas should be watered regularly to avoid dust generation. ▪ The designated site main haul road shall be paved or regular watering. ▪ The public road around the site entrance should be kept clean and free from dust. ▪ Wheel washing facilities including high-pressure water jet shall be provided at the entrance of work site. ▪ Every vehicle shall be washed to remove any dusty materials from its body and wheels before leaving the fill bank. ▪ The temporary slope surfaces shall be covered with impermeable sheet or sprayed with water. ▪ Vehicle and equipment should be switched off while not in use. ▪ All plant and equipment should be well maintained e.g. without black smoke emission. ▪ Open burning should be prohibited. 						
Noise Impact						
<ul style="list-style-type: none"> ▪ The approved method of working, equipment and sound-reducing measures (e.g. use of silenced type of equipment, etc.) shall be adapted. ▪ Only well maintained plant should be operated on-site and plant should be serviced regularly during the construction works. ▪ Powered mechanical equipment (PME) should be covered or shielded by appropriate acoustic materials. ▪ Air compressors and hand held breakers should have noise labels. ▪ Machines and plants that may be in intermittent use should be shut down between work periods or should be throttled down to a minimum. ▪ Noisy equipment and mobile plant shall always be site away from NSRs. 						

	Location	Implementation Status		
		Implemented	Partially implemented	Not implemented
Water Quality				
<ul style="list-style-type: none"> The existing / realigned intercepting channels and the sand / silt removal facilities shall be used and maintained. Temporary intercepting drains should be used at the stockpiling area to divert polluted stormwater to the intercepting channels. Earth bunds and sand bay barriers shall be used to assist the diversion of polluted stormwater to the intercepting channels. The stormwater intercepting system shall be effective to collect of runoff and remove suspended solids before discharge. The material shall be properly covered to prevent washed away especially before rainstorm. The temporary slope surfaces shall be covered with impermeable sheet or sprayed with water. Existing and newly constructed Catchpits, sand and silt removal facilities and intercepting channels shall be maintained, and the deposited silt and grit shall be removed weekly and on a need basis especially at the onset of and after each rainstorm to ensure that these facilities are functioning properly at all times. A wheel washing bay shall be provided at the site exit and wash-water shall have sand and silt settled out or removed before being discharged into storm drains. The section of construction road between wheel washing bay and the public road shall be paved with concrete, bituminous materials or hardcores to reduce vehicle tracking of soil and to prevent site run-off from entering public road drains. Sewage from toilets shall be discharged in to a foul sewer, or chemical toilets shall be provided. The chemical toilets (if use) shall be provided by a licensed contractor, who will be responsible for disposal and maintenance of these facilities. Adequate environmental control measures shall be provided to prevent / avoid dropping of fill material into the sea during the transfer. A waste collection vessel shall be deployed to remove floating debris. 				
Landscape and Visual				
<ul style="list-style-type: none"> The maximum stockpiling height at the fill bank shall be limited to a maximum of +40mPD. Surface of outer slopes of the Fill Bank shall preferably be hydroseeded. Stockpile of public fill shall be removed in a sequence to allow the outer hydroseeded to be removed later than other portions as far as practicable. Casuarina equisetifolia were planted as buffer tree along the northern perimeter of the Site. The height of Casuarina equisetifolia was maintained at least 3m above soil level. Lighting shall be set to minimise night-time glare. 				
Waste Management				
<ul style="list-style-type: none"> Relevant licence / permits for disposal of construction waste or excavated materials available for inspection. Excavated material to be generated from construction works to be re-used on-site as far as practicable to reduce off-site disposal. Mud and debris should be removed from waterworks access roads and associated drainage systems. 				

	Location	Implementation Status			
		Implemented	Partially implemented	Not implemented	Not Applicable
Environmental Protection Measures					
<ul style="list-style-type: none"> Segregation and storage of different types of waste in different containers, skips or stockpiles to enhance reuse or recycling of materials and their proper disposal. Prior to disposal of C&D waste, recyclable materials should be salvaged for reuse (such as wood and metal) and inert waste utilised as public fill to minimise the quantity of waste to be disposed of to landfill. In order to monitor the disposal of C&D material and solid wastes at public filling areas and landfills, and to control fly-tipping, a trip-ticket system should be included as one of the contractual requirements. Any soil contaminated with chemicals/oils shall be removed from site and the void created shall be filled with suitable materials. 	All areas	√			
Chemical Waste Management					
<ul style="list-style-type: none"> It is required to register as a chemical waste producer if chemical wastes would be produced from the construction activities. The Waste Disposal Ordinance (Cap 354) and its subsidiary regulations in particular the Waste Disposal (Chemical Waste) (General) Regulation should be observed and complied with for control of chemical wastes. After use, chemical wastes (e.g. cleaning fluids, solvents, lubrication oil and fuel) should be handled according to the Code of Practice on the Packaging, Labelling and Storage of Chemical Wastes. Spent chemicals should be stored and collected by an approved operator for disposal at the Chemical Waste Treatment Facility or other licensed facility in accordance with the Chemical Waste (General) Regulation. Chemical wastes should be separated for special handling and appropriate treatment at the Chemical Waste Treatment Facility. Chemical wastes including waste oil should be stored properly in designated areas, e.g. chemical waste storage area. The designated chemical waste storage area should only be used for storing chemical wastes. 	Waste Storage Area	√			
The set-up of chemical waste storage area should					
<ul style="list-style-type: none"> Be suitable for the substance they are holding, resistant to corrosion, maintained in a good condition. Be enclosed on at least 3 sides and securely closed. Have an impermeable floor and bunding, of capacity to accommodate 110% of the volume of the largest container or 20% by volume of the chemical waste stored in that area, whichever is the greatest. Have adequate ventilation. Be covered to prevent rainfall entering (water collected within the bund must be tested and disposal as chemical waste if necessary). Be arranged so that incompatible materials are adequately separated. Warning panels should be displayed at the waste storage area. Waste storage area should be cleaned and maintained regularly. Chemical waste should be transported by a registered chemical waste collector to a facility licensed to receive chemical waste. 	Waste Storage Area	√			
	Waste Storage Area	√			
	Waste Storage Area	√			
	Waste Storage Area	√			
	Waste Storage Area	√			
	Waste Storage Area	√			
	Waste Storage Area	√			
	Waste Storage Area	√			
	Waste Storage Area	√			
	Waste Storage Area	√			
	Waste Storage Area	√			
	Waste Storage Area	√			
	All areas	√			

Remark: √ = Implemented, ∇ = Partially Implemented, X = Not Implemented, N/A = Not Applicable

Environmental Protection Measures	Location	Implementation Status		
		Implemented	Partially implemented	Not implemented
• All generators, fuel and oil storage should be within bundle areas.	All areas	√		
• Oil leakage from machinery, vehicle and plant should be prevented.	All areas		√	
• In the event of chemical waste / dangerous goods / chemicals spillage or leakage, the procedures as outlined in the Spillage Response Plan should be followed.	All areas	√		
• The dangerous goods / chemical spillage or leakage procedures (including equipments) should be in place.	All areas	√		
Good Site Practices				
• Nomination of approved personnel, such as site manager, to be responsible for good site practices, arrangements for collection and effective disposal to an appropriate facility, of all wastes generated at the site.	All areas	√		
• Training of site personnel in proper waste management and chemical handling procedures should be provided.	All areas	√		
• Good site practices should be adopted to clean the rubbish and litter on a regular basis so as to prevent the rubbish and litter from dropping into the nearby environment.	All areas		√	
• Proper storage and site practices to minimise the potential for damage or contamination of construction materials.	All areas	√		
• The Environmental Permit should be displaced conspicuously on site.	Site Entrance	√		
• Construction noise permits should be posted at site entrance or available for site inspection.	Site Entrance			√
• Plan and stock construction materials carefully to minimise amount of waste generated and avoid unnecessary generation of waste.	All areas	√		
• Chemical storage area provided with lock and located on sealed areas.	Chemical Storage Area	√		
• All chemicals should be placed at the banded area with adequate band capacity (>110% of largest tank).	Chemical Storage Area	√		
• Any unused chemicals or those with remaining functional capacity should be recycled.	All areas	√		
• Regular cleaning and maintenance programme for waste storage area, drainage systems, silt traps, surmps and oil interceptors.	All areas	√		
• To encourage collection of aluminium cans by individual collectors, separate labelled bins should be provided to segregate this waste from other general refuse generated by the workforce.	All areas	√		
• A recording system for the amount of wastes generated, recycled and disposed (including the disposal sites) should be used, e.g. trip ticket system for chemical waste disposal. Quantities could be determined by weighing each load or other suitable methods.	All areas	√		
• A collection area should be provided where waste can be stored and loaded prior to removal from site. An enclosed and covered area is preferred to reduce the occurrence of 'wind blown' light material. If an open area is unavoidable for the storage or loading/unloading of wastes, then the area should be banded and all the polluted surface run-off collected within this area should be diverted into wastewater treatment system.	All areas	√		
• Remove wastes in a timely manner.	All areas		√	



Appendix I

Statistical Analysis of the Trend of Suspended Solids in the Quarter



Statistical Analysis of the Trend of Suspended Solids

For Mid-Flood Tide

Station: TM-FM1

t-test

Group Name	N	Missing	Mean	Std Dev	SE
130% Baseline Mean	12	0	5.9733	1.3518	0.4076
Quarterly Mean	38	0	9.1946	0.7410	0.1218

Result:

Probability that two variances are equal (f-test) = 0.00292

Difference between means = 3.2213 (Std Dev = 1.4808 and SE = 0.4083)
(95% CI : 2.421 < Diff < 4.0216)

t-value of difference = 7.889 (13 degrees of freedom)
P = 0 (<0.05)

Conclusion:

There is a statistically significant difference between the groups.

Station: TM-FM2

t-test

Group Name	N	Missing	Mean	Std Dev	SE
130% Baseline Mean	12	0	6.0267	1.1748	0.3542
Quarterly Mean	38	0	9.2586	0.7978	0.1312

Result:

Probability that two variances are equal (f-test) = 0.03898

Difference between means = 3.2319 (Std Dev = 1.3749 and SE = 0.363)
(95% CI : 2.5204 < Diff < 3.9434)

t-value of difference = 7.997 (19 degrees of freedom)
P = 0 (<0.05)

Conclusion:

There is a statistically significant difference between the groups.



Statistical Analysis of the Trend of Suspended Solids

For Mid-Flood Tide

Station: TM-FC1

t-test

Group Name	N	Missing	Mean	Std Dev	SE
130% Baseline Mean	12	0	6.6942	1.8839	0.5680
Quarterly Mean	38	0	9.6617	0.5824	0.0957

Result:

Probability that two variances are equal (f-test) = 0

Difference between means = 2.9675 (Std Dev = 1.8857 and SE = 0.552)
(95% CI : 1.8856 < Diff < 4.0494)

t-value of difference = 5.376 (11 degrees of freedom)
P = 0.0001 (<0.05)

Conclusion:

There is a statistically significant difference between the groups.

Station: TM-FC2

t-test

Group Name	N	Missing	Mean	Std Dev	SE
130% Baseline Mean	12	0	6.3067	1.8674	0.5630
Quarterly Mean	38	0	9.1401	0.8557	0.1407

Result:

Probability that two variances are equal (f-test) = 0.00016

Difference between means = 2.8334 (Std Dev = 1.9674 and SE = 0.5567)
(95% CI : 1.7424 < Diff < 3.9244)

t-value of difference = 5.09 (12 degrees of freedom)
P = 0.0003 (<0.05)

Conclusion:

There is a statistically significant difference between the groups.



Statistical Analysis of the Trend of Suspended Solids

For Mid-Ebb Tide

Station: TM-FM1

t-test

Group Name	N	Missing	Mean	Std Dev	SE
130% Baseline Mean	12	0	7.0008	1.6394	0.4943
Quarterly Mean	38	0	9.1708	0.7279	0.1197

Result:

Probability that two variances are equal (f-test) = 0

Difference between means = 2.17 (Std Dev = 1.7174 and SE = 0.4878)
(95% CI : 1.214 < Diff < 3.126)

t-value of difference = 4.449 (12 degrees of freedom)
P = 0.0009 (<0.05)

Conclusion:

There is a statistically significant difference between the groups.

Station: TM-FM2

t-test

Group Name	N	Missing	Mean	Std Dev	SE
130% Baseline Mean	12	0	7.2758	1.5293	0.4611
Quarterly Mean	38	0	9.1956	0.8539	0.1404

Result:

Probability that two variances are equal (f-test) = 0.0038

Difference between means = 1.9198 (Std Dev = 1.6832 and SE = 0.4627)
(95% CI : 1.0129 < Diff < 2.8267)

t-value of difference = 4.149 (13 degrees of freedom)
P = 0.0008 (<0.05)

Conclusion:

There is a statistically significant difference between the groups.



Statistical Analysis of the Trend of Suspended Solids

For Mid-Ebb Tide

Station: TM-FC1

t-test

Group Name	N	Missing	Mean	Std Dev	SE
130% Baseline Mean	12	0	7.6392	1.5074	0.4545
Quarterly Mean	38	0	9.6939	0.6189	0.1017

Result:

Probability that two variances are equal (f-test) = 0

Difference between means = 2.0547 (Std Dev = 1.5593 and SE = 0.4466)
(95% CI : 1.1794 < Diff < 2.93)

t-value of difference = 4.601 (12 degrees of freedom)
P = 0.0006 (<0.05)

Conclusion:

There is a statistically significant difference between the groups.

Station: TM-FC2

t-test

Group Name	N	Missing	Mean	Std Dev	SE
130% Baseline Mean	12	0	6.6950	1.9561	0.5898
Quarterly Mean	38	0	9.1930	0.7353	0.1209

Result:

Probability that two variances are equal (f-test) = 0

Difference between means = 2.498 (Std Dev = 1.999 and SE = 0.5771)
(95% CI : 1.3668 < Diff < 3.6292)

t-value of difference = 4.328 (11 degrees of freedom)
P = 0.001 (<0.05)

Conclusion:

There is a statistically significant difference between the groups.



Appendix J
Site General Layout plan

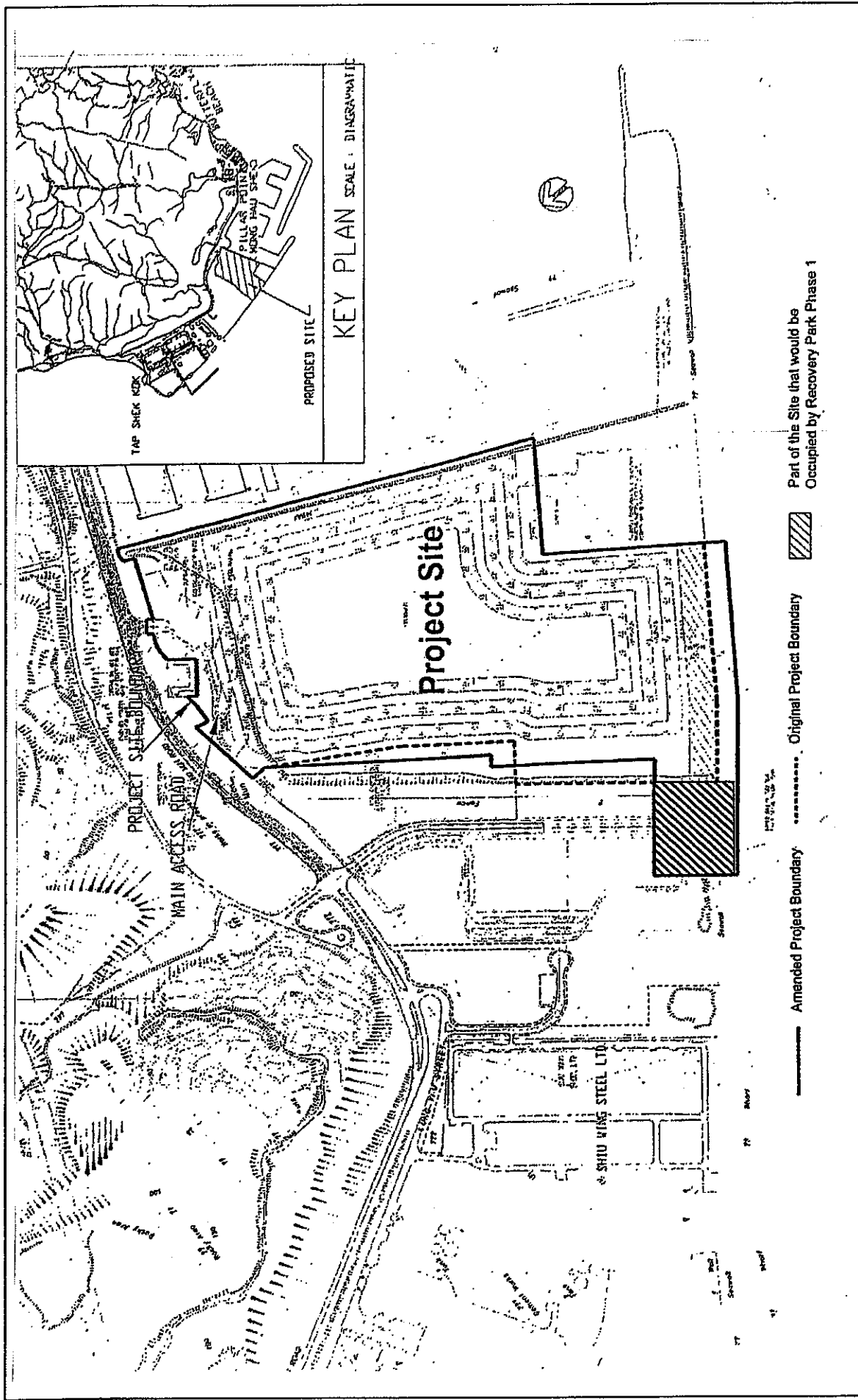

CEDD Contract No. CV/2005/01 Delivery of Reclamation Material to Mainland

Scale : ---
Date issued : December 2006

Figure 1 Site Layout Plan - Tuen Mun Area 38 Fill Bank



Figures

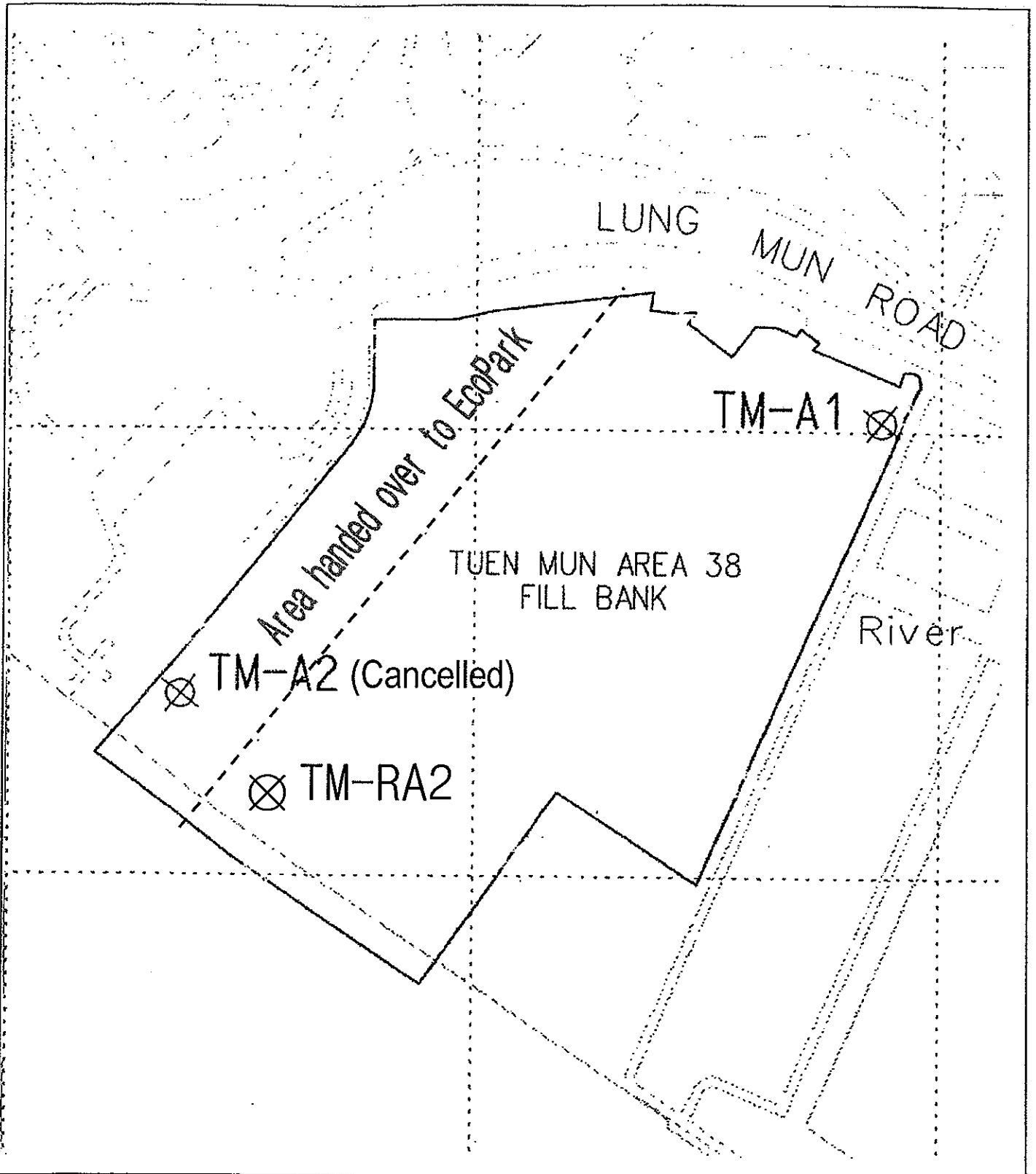

Contract No. CV/2005/01
 Delivery of Reclamation Material to Mainland

Figure 2 A
 Locations of Air Quality Monitoring Stations –
 Tuen Mun Area 38 Fill Bank



東業德勤測試顧問有限公司
 ETS-TESTCONSULT LIMITED

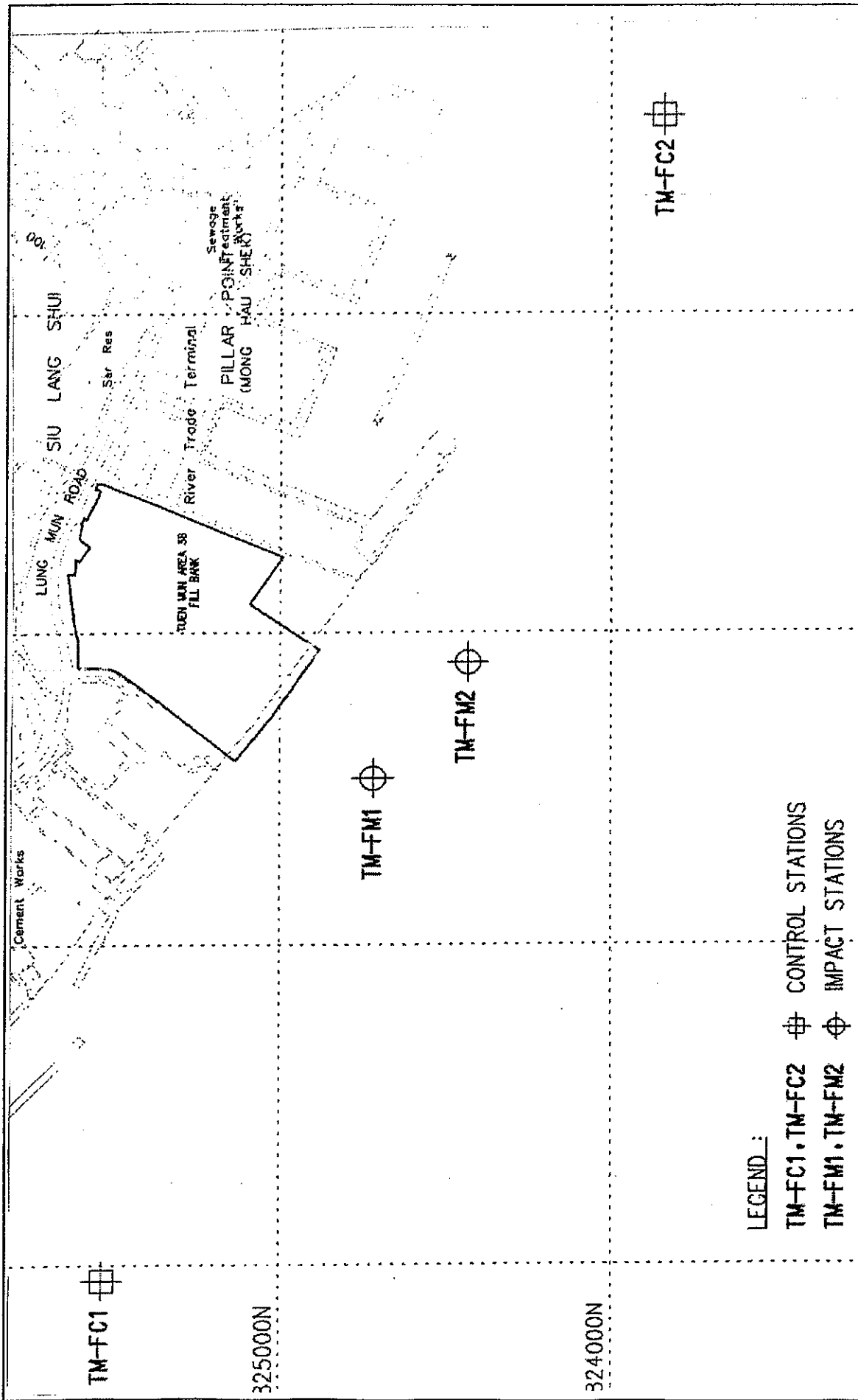

CEDD Contract No. CV/2005/01 Delivery of Reclamation Material to Mainland

Scale : ---

Date issued :
December 2006

Figure 3 Locations of Water Quality Monitoring Stations - Tuen Mun Area 38 Fill Bank



東業德動測試顧問有限公司
ETS-TESTCONSULT LIMITED

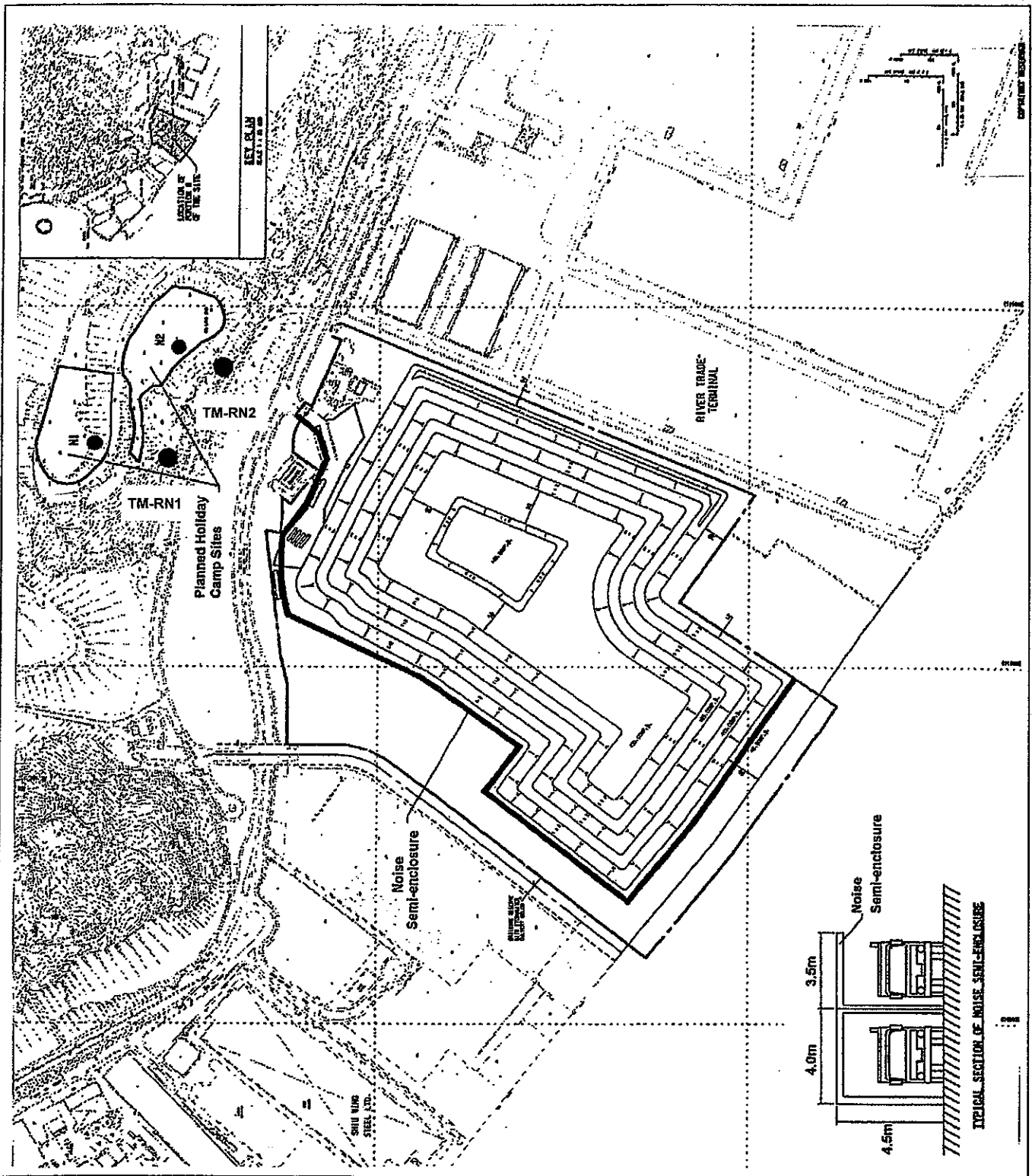

Contract No. CV/2005/01
 Delivery of Reclamation Material to Mainland

Figure 4
 Locations of Noise Quality Monitoring Stations –
 Tuen Mun Area 38 Fill Bank