



俊和 - 中國中鐵聯營

CHUN WO - CRGL JOINT VENTURE

Contract No. HK/2009/02

Wan Chai Development Phase II

Central - Wan Chai Bypass at Wan Chai East

Silt Screen Deployment Plan

Silt Screen Deployment Plan

E	03/04/13	Updated set of submission	P F Sung	Garry Law
D	13/11/12	Updated set of submission	Cecil Cheng	Garry Law
C	02/05/12	Full Set of Submission	Jeff Chu	Garry Law
B	07/01/12	Submission for Approval	Cecil Cheng	Garry Law
A	12/04/10	Submission for Approval	Cecil Cheng	P C Chan
0	11/03/10	Submission for Approval	Cecil Cheng	P C Chan
Rev	Date	Status	Prepared By	Reviewed and Approved By Construction Manager



LIST OF CONTENTS

1.0 Introduction

2.0 List of documentation to be referenced

3.0 General Layout of Location of Silt Screen

4.0 Deployment Schedule

5.0 Installation Method

6.0 Maintenance and Removal

7.0 Technical Details and Materials for the Silt Screen

8.0 Liaison Results with the Intake Owner and Operator

9.0 Appendices



1.0 Introduction

The purpose of this deployment plan is to illustrate the general layout, the construction programme, details on the design, operation and maintenance of the silt screens to be installed for the dredging and filling works of “Wan Chai Reclamation” as recommended in the approved EIA report (Registration No.: AEIAR-125/2008). Chun Wo - CRGL Joint Venture is responsible for the installation, operation, maintenance and removal of the silt screen.

2.0 List of documentation to be referenced

2.1 Particular Specification, the relevant clauses and our remarks for the works are listed as follows for ease of references.

PS Clause No.	Relevant Remarks
PS Appendix 25.4, EP No. EP-356/2009 Clause 2.9 refers.	The permit holder shall liaise with the owners and the operators of the seawater intakes on details of silt screen installation, maintenance and removal at the seawater intakes.
PS Appendix 25.4, EP No. EP-356/2009 Clause 2.9 refers.	At least two weeks prior to the commencement of the marine works, the permit holder shall deposit with the Director four hard copies and one electronic copy of a silt screen deployment plan to provide details of the design, operation and maintenance requirement of the silt screen systems.
PS Appendix 25.4, EP No. EP-356/2009 Clause 2.9 refers.	The silt screen deployment plan shall be certified by the ET Leader and verified by the IEC as conforming to the relevant information and recommendation contained in the approved EIA report (Reg. No. AEIAR-125/2008) and liaison results with the owners and the operators of the seawater intakes.
PS Appendix 25.4, EP No. EP-356/2009 Clause 2.9 refers.	Silt screens shall be installed at seawater intakes prior to the commencement of the corresponding marine works.
PS Appendix 25.4, EP No. EP-356/2009 Clause 2.9 refers.	To avoid refuse entrapment and to ensure representative impact monitoring results, silt screens shall be maintained and refuse around them shall be collected at regular intervals on a daily basis so that water behind the silt screens be kept free from floating debris during the impact monitoring period.

3.0 General Layout of Location of Silt Screen

3.1 The deployment of Silt Screen would be divided into three phase as follow:

3.1.1 **Phase 1 Silt Screens** to be deployed prior to the reclamation works of WCR1. The silt screen to be installed at the existing **WSD salt water intakes** and existing **Sun Hung Kai Centre intakes**. It is anticipated to be installed by **mid**



of April 2010 and would be maintained for approximate **38 months** until the commissioning of the new WSD salt water pumping station and new Sun Hung Kai Centre pumping station by end of **June 2013**.

3.1.2 **Phase 2 Silt Screens** to be deployed prior to the reclamation works of WCR2. The silt screen to be installed at the temporary diversion intakes of **WSD salt water pumping station, Sun Hung Kai pumping station**. It is anticipated to be installed by **beginning of March 2012** and would be maintained for approximately **16 months** until the commissioning of the new WSD salt water pumping station and new Sun Hung Kai Centre pumping station by end of **June 2013**.

3.1.3 **Phase 3 Silt Screens** to be deployed prior to the commissioning of the new WSD salt water pumping station and new Sun Hung Kai Centre pumping station. The silt screen to be installed at the intakes of proposed **WSD salt water pumping station, proposed Sun Hung Kai pumping station, proposed China Resource Building pumping station** and proposed **Great Eagle Centre/ harbour Centre pumping station**. It is anticipated to be installed by **June 2013** and would be maintained for approximately **30 months** until the anticipated completion of all marine works by mid December 2015. Due to irregular shape of wave absorption chamber with slot panels, penstocks and the coarse screens at the sea side face in the Engineer's Design which shown in the Figure 1, the installation of a water tight steel frame structure is physically unfeasible. In these connections, double-layer silt curtain screen is adopted as the silt screen to safeguard the water intake quality.

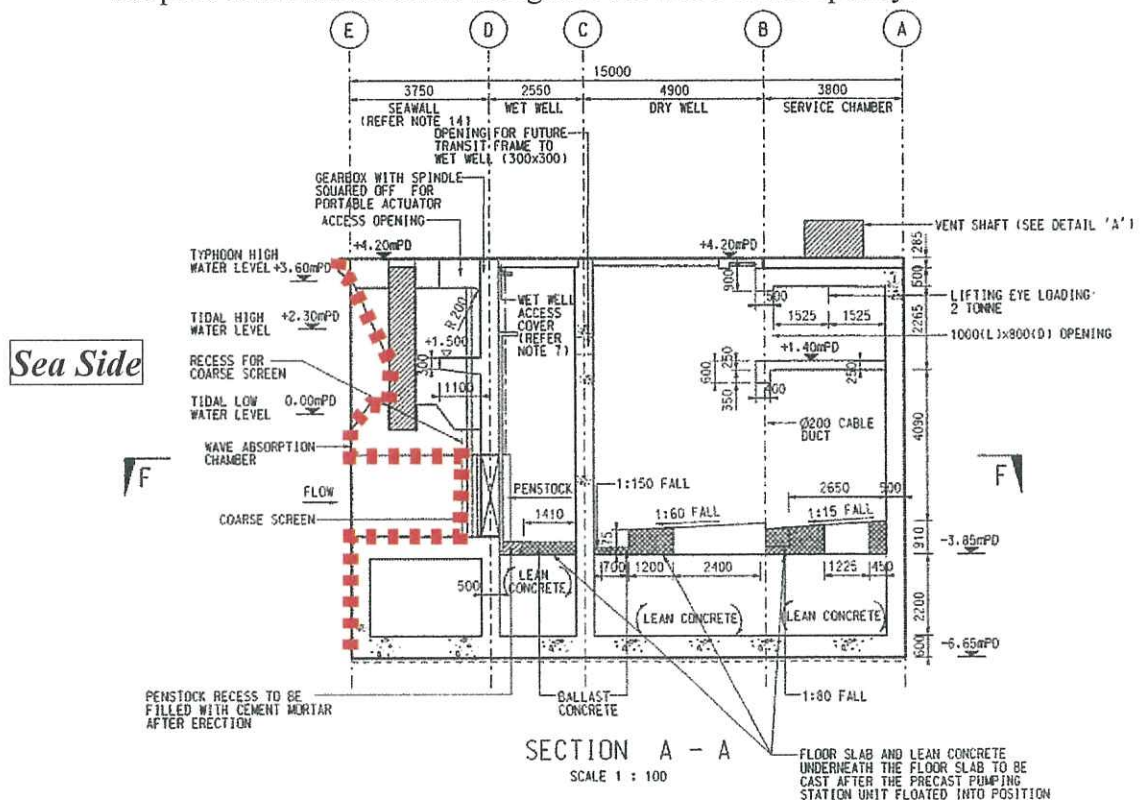

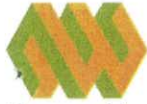

Figure 1. Cross Section of Pumping Station

3.2 The layout plans and schedule for deployment of silt screens at different phases mentioned should refer to Appendix A.

4.0 Deployment Schedule

4.1 The deployment schedule of the curtain screens could refer to the table below. It is prepared based on the Programme and may subject to changes to reflect the actual site progress:

Staging	Anticipated Installation Works		Silt Screen to be Maintained until	Anticipated Removal by (b)	Total Duration, days = (b) - (a)
	From (a)	To			
Phase 1	15 April, 2010	30 April, 2010	30 June 2013	31 October 2013	1295
Phase 2	01 March, 2012	15 March, 2012	30 June 2013	31 October 2013	609
Phase 3	15 June 2013	30 June 2013	15 December 2015	31 December 2015	929

4.2 Silt screens installations would be completed prior to the commencement of relevant phase of dredging works, the silt screens would only be removed upon completion of the relevant phases or as agreed with the Engineer.

5.0 Installation Method

5.1 Preparation

5.1.1 Prior to installation of the silt screen, the contractor would liaise with relevant operators for the operation. The pump stations each consist of 2 to 4 number of water intake pipes. Temporary suspension of pump of each intake pipe in turns is required prior to the installation of the respective silt screen system to each intake pipe. The silt screen to each water intake pipe would be installed one by one such that the overall operations of the pump house would not be adversely affected. The schedule of installation works should be agreed by the relevant stakeholders.

5.1.2 The silt screen system for phase 1 and phase 2 works would consist of a frame mounted on the external wall of the intake, and a steel fence with geotextile to be inserted into the frame. The silt screen system would be pre-fabricated prior to the installations. Extra number of steel fences with geotextile would be



fabricated as standby unit in case of any repairing works required in the future. The details of the pre-fabrication units should refer to Appendix B.

- 5.1.3 The silt screen system for phase 3 works would consist of double layer of silt curtain screen at approximate 10m clearance from the external wall of the intakes. The silt curtain would enhance the water quality at the intakes by reducing the incoming of any potential muddy water body. The layout and details of the silt curtain screen for phase 3 works shall refer to Appendix H and Appendix I respectively.
- 5.2 Installation of the wall mounted frame
- 5.2.1 The relevant pump of water intake pipe should be switched off. The pre-fabricated steel frame would be lifted to the required position by use of mobile crane.
- 5.2.2 A foreman would be sited at location near the shoreline to supervise the operation.
- 5.2.3 Divers would be located at sea near the shoreline to help placing the steel frame in position and for installation of the frame to the external wall of the water pump house by bolt and nuts anchorage.
- 5.2.4 Holes drilling to the external wall would be carried out by the divers using pneumatic air driller and Hilti bolt Type HSL-3 or equivalent would be adopted as the anchorage system.
- 5.2.5 Refer to Appendix C for the graphical illustration of the installation of the wall mounted steel frame.
- 5.3 Installation of the silt screen fencing into the wall mounted frame
- 5.3.1 The relevant silt screen fencing should be inserted into the wall mounted frame. A foreman would be sited at location near the shoreline to supervise the operation.
- 5.3.2 The pump of water intake pipe should be switched off. The pre-fabricated silt screen fencing would be lifted to the required position by use of mobile crane or crane barge.
- 5.3.3 Divers would be located at sea near the shoreline to help placing of the silt screen fencing to proper positions. A steel wire would be installed to the lifting eye of the silt screen fencing for ease of later maintenance. The steel wire would then be brought up to the ground level and fix to the chain block pulley would to be installed on land.
- 5.3.4 Refer to Appendix C for the graphic illustration of the installation of the silt screen fencing into the wall mounted frame.



5.4 Installation of silt curtain screen

5.4.1 Preparation Works

5.4.1.1 Unload the material that have been shipped from the plant by using crane lorry and arrange in orderly way

5.4.1.2 Check the unloaded materials for their dimension and sizes according to the member list.

5.4.2 Setting Up

5.4.2.1 All silt curtain units installation would be carried out at locations as indicated in the drawings as attached in Appendix H;

5.4.2.2 Surveyors would check and set out for propose alignment on site

5.4.2.3 Whenever adjustment is required for the proposed locations due to unexpected site constraint, prior agreement from the Engineer would be sought.

5.4.3 Assembling Preparation (On land)

5.4.3.1 Prepare temporary tying rope for one span of silt curtain and to tie the curtain and float together;

5.4.3.2 Spread the curtains in the assembling yard;

5.4.3.3 Place the unloaded silt curtain units on the temporary tying rope pieces that have been arranged by the crane;

5.4.3.4 Use tape that is attached to the float attaching sections of the silt curtain that is spread on the yard to fix the floats that have been delivered separately;

5.4.3.5 After fixing the floats, close the opening of the cover by using joint rope;

5.4.3.6 Use rope to tie the weight chain that has been delivered separately to the bottom end of the curtain of the silt curtain that is spread on the yard;

5.4.3.7 Attach chain hanging belts at ~5m interval to fix the chain;

5.4.3.8 Check the spread silt curtain entirely that all the members and parts are attached normally.

5.4.4 Vertical joining of span

5.4.4.1 Couple the tension metals with shackles (for connection) at both ends of each span. During the work, attach upper anchor rope to the shackles for joining curtains by using shackles;

5.4.4.2 Use the knot that was used for closing the float cover for vertical joining of curtains.

5.4.5 Temporary tying curtains

5.4.5.1 Before loading the assembled silt curtain on the barge, haul in the spread curtain to the float side, and tie the float and curtain together by using curtain temporary tying rope pieces that were arranged before hand below the float.

5.4.6 Installing sinkers



- 5.4.6.1 Load sinkers placed on the land onto the barge by using crane;
- 5.4.6.2 Tow the barge loaded with sinkers to the site;
- 5.4.6.3 Attach lower sinkers ropes to the sinkers by using a specified shackle;
- 5.4.6.4 Attach auxiliary float/marker buoy to upper end of the lower sinkers rope;
- 5.4.6.5 Use the crane to lower sinkers to the points that were determined by survey and install them.

5.4.7 Installing Silt Curtain

The installation of silt curtain can be classified mainly into the following 2 methods:

- Loading on the barge and towing the barge to the site.
- Towing directly to the site.

5.4.8 Loading on the barge and towing the barge to the site

- 5.4.8.1 Use crane on land or the one on the floating platform to load the silt curtain units assembled on land onto the barge;
- 5.4.8.2 Arrange silt curtain units on the barge such that they can be pulled out in proper direction at the placement in the sea;
- 5.4.8.3 Tow the barge loaded with silt curtain units and the crane platform/derrick lighter to the placement site;
- 5.4.8.4 When the barge and crane platform/derrick lighter arrives at the placement site, anchor them at the predetermined location;
- 5.4.8.5 Hoist silt curtain unit at the end and put in into the sea. Keep the other end of the unit on the working space of the barge by tying it to the bit of the barge with rope to prevent from moving. Then vertically join with the next silt curtain unit and attach upper anchor rope. Before this step, remove the racking rope (curtain temporary tying rope) at the end;
- 5.4.8.6 After joining the curtains at the above step, temporary tie the curtains with racking rope again;
- 5.4.8.7 After completing the joining works and attaching the anchor rope, put the silt curtain unit onto the sea while reversing the barge;
- 5.4.8.8 When all the units are placed on the sea, let the divers remove the curtain temporary tying rope that ties the float and the curtain at assembling to hang the curtain in the sea;
- 5.4.8.9 After completing the installation, use the divers to check the states of the connections, joints and moorings.

5.4.9 Towing directly to the site

- 5.4.9.1 Join the towing rope to the weight chain of the silt curtain units. Hoist the silt curtain units and put it on the sea surface from the towing end;
- 5.4.9.2 Pull the joined spans of silt curtain units by moving the towing boat ahead slowly until all units float on the sea;
- 5.4.9.3 Tow silt curtain units slowly to the placement site;
- 5.4.9.4 Use the divers/workers on the barge to moor the towed silt curtains units to the lower anchor rope attached to anchor block using the upper anchor



rope attached to the body of silt curtain units with shackle. Drag in the anchor rope joint by using the winch and rope of the divers boat or of the winch boat;

5.4.9.5 When all the units are placed on the sea, let divers remove the curtain temporary tying rope that ties the float and the curtain at assembling to hang the curtain in the sea;

5.4.10 After completing the installation, use divers to check the condition of the connections, joint and moorings.

5.5 Silt Screen has been designed to have sufficient clearance from the external wall of the pump houses to allow placing of relevant equipment by Environmental Team to carry out water measurement and sampling behind the screens. Either marine access or land access would be maintained at all time for the Environmental Team to perform their monitoring duties, layout plans illustrating the access routes are attached in Appendix G.



6.0 Maintenance and Removal

- 6.1 Site foreman and supervisors will be assigned to check the condition of the silt screens at regular intervals on a daily basis during the course of the marine works. An inspection checklist with format as attached in Appendix D would be used for recording the conditions of the silt screens.
- 6.2 Completed checklists will be kept on site for record.
- 6.3 If silt screens are found damaged and repairing works are identified as necessary, all marine works at our works area in relation to the location of silt screens would be suspended. The silt screens would be lifted up from the sea by using chain block pulley system, and the damaged parts (e.g. geotextile filter, steel mesh, steel frame, curtain fabric, shackles, buoys...etc) of silt screens would be replaced.
- 6.4 The suspended marine works as mentioned could only be resumed after satisfactorily repairing of the damaged silt screens.
- 6.5 As regular maintenance, refuse collection around the silt screens would be carried out on daily basis to avoid blockage of sea water flow by floating debris.
- 6.6 Spare geotextile materials, curtain fabric and pre-fabricated silt screen would be stored on site. It would be treated as standby materials to allow for prompt replacement in case of any damages the silt screens observed.
- 6.7 Prior to removal of the silt screen, the contractor would liaise with relevant operators for the shutting down of system or reduce of intake rate by turning off 1 or 2 pumps. The silt screen would then be lifted up by using chain block pulley system. Any screw nuts of anchor bolts find to be loosen under the water level would be tied up immediately by divers.

7.0 Technical Details and Materials for the Silt Screen

- 7.1 The Silt Screens would be pre-fabricated on site prior to installation to the relevant intakes. The typical details and calculation checking of the silt screen system should refer to Appendix B. ICE checking certificates would be separately submitted to the Engineer on site.
- 7.2 The permeable Silt Screens would consist of geotextile materials. The technical properties of the geotextile materials should refer to Appendix E.
- 7.3 The Silt Screen would also consist of steel mesh material as fencing. The technical properties of the steel mesh material should refer to Appendix F. Galvanized mild steel mesh will be used.
- 7.4 All other steel materials for the steel frame to be complied with Grade 43A or S275 standards. All steel materials to be galvanized mild steel.



7.5 The details of Silt Curtain Screen shall refer to appendix I.

8.0 Liaison Results with the Intake Owner and Operator

8.1 Silt Screens for Existing Sun Hung Kei Pump Station Intakes

8.1.1 Responsible person named Mr. Y. C. Lee, posted Senior Maintenance Engineer, tel: 3766 6164, mobile 9160 6832 and e-mail: ycleel@shkmgmt.com.

8.1.2 It is agreed that the silt screens to be mounted on the external wall face of the pump house. The permeable silt screens should be removable type and the screens should be lifted up and removed upon requested from Sun Hung Kei Pump Station for ease of their regular maintenance.

8.1.3 It is principally agreed that the installations of silt screens to be carried out on Saturday. The exact schedule of installation work shall be further coordinated in order to minimize downtime of the sea water pumps.

8.1.4 Trial test shall be performed on site to check the functionality of the silt screens before it is put into full operations.

8.2 Silt Screens for Existing WSD Pump Station Intakes

8.2.1 Responsible person named Mr. K. Y. Hong, posted Inspector Mechanical, tel: 2880 2528 and e-mail: kam_yiu_hong@wsd.gov.hk.

8.2.2 It is agreed that the silt screens to be mounted on the external wall face of the pump house. The permeable silt screens should be removable type and the screens should be lifted up and removed upon requested from Water Supplies Department for ease of their regular maintenance.

8.2.3 It is agreed that the base and sides of the wall mounted frame to be sealed up by fixed steel plate instead of hanging curtain materials, to ensure protection to the intake systems.

8.2.4 The exact date for installation works should be further confirmed with WSD representative prior to operations.

8.3 Silt Screens for other Proposed Pump Station Intakes

8.3.1 Liaisons with relevant owners to be carried out prior to installations of relevant silt screens.

8.3.2 The design and installation details of the silt screens for the proposed pump houses to be discussed and agreed with relevant owners through the engineer and prior to functioning of relevant pump houses.



9.0 Appendices

- 9.1 Appendix A – Silt Screen Deployment Plan
- 9.2 Appendix B – Detailed Drawing and Calculation Checking of the Silt Screen System
- 9.3 Appendix C – Graphical Illustration for the Installations of the Silt Screen System
- 9.4 Appendix D – Daily Inspection Checklist
- 9.5 Appendix E – Technical Properties of the Geotextile Material – Tencate Mirafi FW300
- 9.6 Appendix F – Technical Properties of the Steel Mesh Material – Golik 228G
- 9.7 Appendix G – Access of Environmental Team to carry out water measurement and sampling
- 9.8 Appendix H – Layout of Silt Curtain Screen to be provided to the intakes for phase 3 works.
- 9.9 Appendix I – technical details of Silt Curtain Screen for phase 3 works.
- 9.10 Appendix J – Photo Records of Pumping Station



俊和 - 中國中鐵聯營

CHUN WO - CRGL JOINT VENTURE

Contract No. HK/2009/02

Wan Chai Development Phase II

Central - Wan Chai Bypass at Wan Chai East

Silt Screen Deployment Plan

Appendix A

Silt Screen Deployment Plan

SILT SCREEN SCHEDULE			
ACTIVITY	DURATION	START	FINISH
PHASE 1 SILT SCREEN Installation of silt screen at existing intakes of WSD salt water pump house & SHK Centre pump station prior to WCR1 reclamation & to be maintained until commission of phase 2 silt screen	Approx. 24 months	30/04/10	31/12/12
PHASE 2 SILT SCREEN Installation of silt screen at proposed temporary diversion intake of WSD salt water pump house & SHK Centre pump station prior to WCR2 dredging, rockfilling and reclamation, & to be maintained until commission of new WSD & SHK pumping station	Approx. 6 months	15/02/12	31/12/12
PHASE 3 SILT SCREEN Installation of silt screen at proposed intakes of pump stations of Great Eagle Central Harbour Centre, SHK Centre, China Resource Building, and WSD Salt Water Pump House prior to commissioning of the new pump stations & to be maintained until completion of marine works	Approx. 36 months	15/12/12	15/12/15

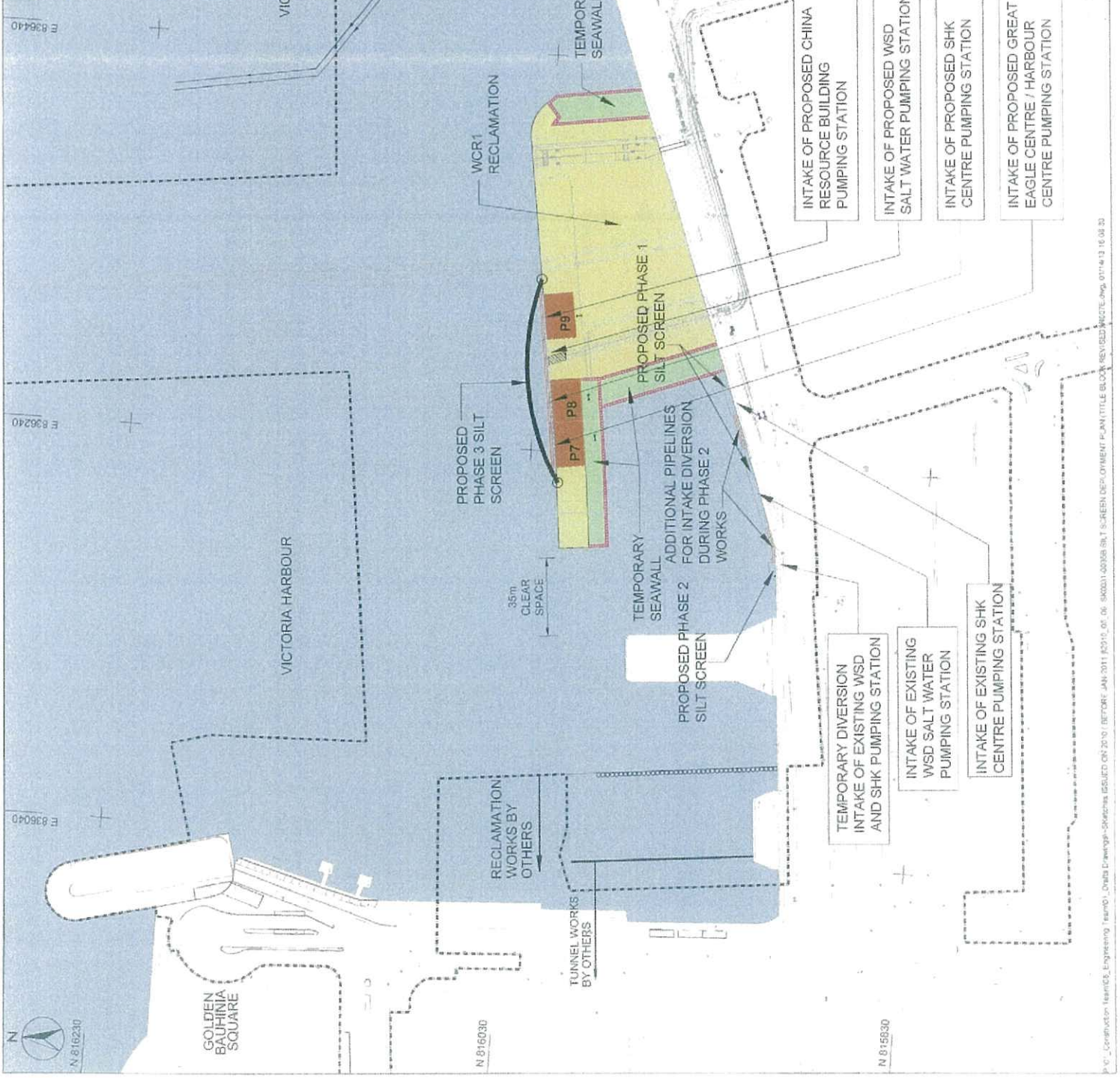

土水工程拓展署
 CEDD
 Civil Engineering and
 Development Department
 土木工程拓展署
 CEDD
 Civil Engineering and
 Development Department
 香港中環德輔道中
 CHINA WSD - CRCL, JOHN VONNESE
 MAY CIVIL DEVELOPMENT PHASE II -
 CENTRAL - MAIN CIVIL BYPASS AT MAIN CHINA EAST
 SILT SCREEN DEPLOYMENT PLAN
 AECOM
 PROJECT NO. HK/2009/02/MIR/807E
 SCALE: 1:2500
 DATE: 15/12/12
 DRAWN BY: [Name]
 CHECKED BY: [Name]
 APPROVED BY: [Name]



俊和 - 中國中鐵聯營

CHUN WO - CRGL JOINT VENTURE

Contract No. HK/2009/02

Wan Chai Development Phase II

Central - Wan Chai Bypass at Wan Chai East

Silt Screen Deployment Plan

Appendix B

Detailed Drawing and Calculation Checking of the Silt Screen System

Design Calculation

Dimensions of steel fence:

Height of steel fence	=	3.050 m
width of steel fence	=	2.250 m
steel fence member	=	50 x 50 x 4mm Equal Angle
no. of steel fence for each frame	=	2.000 nr
weight of steel angle member	=	3.060 kg/m
weight of steel mesh member	=	3.960 kg/m ²
weight of geotextile	=	0.275 kg/m ²

Loading of steel fences:

weight of steel member of each fence	=	32.436 kg
weight of 2 layer of steel mesh for each fence	=	54.351 kg
weight of 1 layer of geotextile for each fence	=	1.887 kg
Therefore, weight of each fence	=	88.674 kg
Factored DL = 1.2 x 10 x 88.674	=	1.064 kN
For 2.000 nr of fence, total factored DL	=	2.128 kN

Dimensions of wall-mounted steel frame:

Height of steel frame	=	6.000 m
width of steel frame	=	2.300 m
steel frame member	=	102 x 51 x 10.6 kg/m
no. of steel frame for each silt screen	=	1.000 nr
weight of steel angle member	=	10.600 kg/m

Loading of wall-mounted frame:

weight of major steel member of the frame	=	175.960 kg
weight of steel members for the MS plates	=	54.263 kg
Therefore, weight of each frame	=	230.223 kg
Factored DL = 1.2 x 10 x 230.223	=	2.763 kN

All steel material use to be Grade S275

Capacity Check for the Steel Frame:

Check Bending to the bottom member of frame

$$\begin{aligned} \text{design UDL} &= 2.128 \text{ kN} \\ \text{max. bending moment} &= 0.125 \times \text{UDL} \times L^2 \\ &= 1.347 \text{ kNm} \end{aligned}$$

$$\begin{aligned} \text{Use } 102 \times 51 \times 10.6 \text{ kg/m} \\ Z &= 8140.000 \text{ mm}^3 \\ \text{max. bending stress} &= 165.447 \text{ N/mm}^2 \\ &< 275.000 \text{ N/mm}^2 \end{aligned}$$

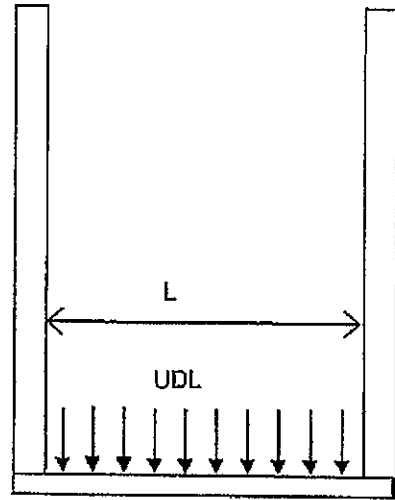

OK

Check Shear at Support of the bottom steel frame

$$\begin{aligned} \text{max. shear force, } V &= 2.394 \text{ kN} \\ \text{cross section area} &= 1330.000 \text{ mm}^2 \\ \text{max. shear stress} &= 1.800 \text{ N/mm}^2 \\ &< 165.000 \text{ N/mm}^2 \end{aligned}$$

OK

Check Tension on the vertical members of the steel frame

$$\begin{aligned} \text{max. shear force, } V &= 2.394 \text{ kN} \\ \text{total DL of the steel frame} &= 2.763 \text{ kN} \\ \text{DL at each vertical member} &= 1.381 \text{ kN} \\ \text{cross section area} &= 1330.000 \text{ mm}^2 \\ \text{max. tensile force} &= 3.776 \text{ kN} \\ \text{max. tensile stress} &= 2.839 \text{ N/mm}^2 \\ &< 275.000 \text{ N/mm}^2 \end{aligned}$$

OK

Apply 4mm fillet welds to all connections unless otherwise stated

Welding Check:

$$\begin{aligned} \text{max. shear force} &= 2.394 \text{ kN} \\ \text{welding length required} &= \frac{2.394 \times 1000}{215.000 \times 4 \times 0.7} \\ &= 28.750 \text{ mm} \\ \text{Provide welding length} &= 50.000 \text{ mm} \quad \text{OK} \end{aligned}$$

Capacity Check for the Cantilever Arm:

Check Bending to the cantilever arm

$$\begin{aligned} \text{Cantilever arm} &= 0.800 \text{ m} \\ \text{Number of support at each side} &= 2.000 \text{ nr} \\ \text{max. bending moment} &= V \times \text{cantilever arm} / \text{nr of support} \\ &= 0.958 \text{ kNm} \\ \text{Use } 50 \times 50 \times 2.5\text{mm} &\times 3.68 \text{ kg/m} \\ Z &= 6990.000 \text{ mm}^3 \\ \text{max. bending stress} &= 137.007 \text{ N/mm}^2 \\ &< 275.000 \text{ N/mm}^2 \end{aligned}$$

Check Shear at the cantilever arm

$$\begin{aligned} \text{max. shear force, } V &= 2.394 \text{ kN} \\ \text{Number of support at each side} &= 2.000 \text{ nr} \\ \text{cross section area} &= 468.000 \text{ mm}^2 \\ \text{max. shear stress} &= 2.558 \text{ N/mm}^2 \\ &< 165.000 \text{ N/mm}^2 \end{aligned}$$

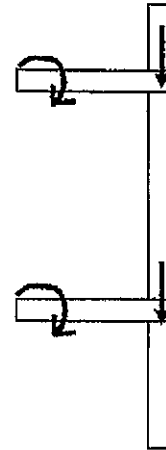

Capacity Check for the Anchorage Bolts:

Total factored DL of the steel frame and steel fence, W:

$$W = 4.891 \text{ kN}$$

Nos. of anchor bolts provided = 4.000 nr

max. shear force to each bolt = 1.223 kN

Use HSL-G-R M12 with 80mm anchorage length

max. allowable Shear Force at each bolt = 24.4 kN

$$> 1.223 \text{ kN OK}$$

Allowable Flow Capacity of the Silt Screen

Flow capacity of the Geotextile FW300 = 90.000 L/m²/s

Total flow capacity allowable for each screen

$$= 2.25 \times 3.05 \times 2 \times 90$$

$$= 1235.25 \text{ L/s}$$

$$> \text{required flow rate} = 375 \text{ L/s}$$

OK

Design resistance, R_d [kN]: $f_{ctd} = 30 \text{ N/mm}^2$

Anchor size	M8	M10	M12	M16	M20
Tensile, $N_{t,Rd}$	10.4	15.1	19.4	30.9	47.3
Combined load	11.8	17.0	24.1	41.8	64.0
Shear, $V_{s,Rd}$	31.4	28.7	36.1	52.7	82.0
	14.0	23.8	34.1	53.6	99.3

Recommended load, $F_{s,R}$ in [kN], $f_{ctd} = 30 \text{ N/mm}^2$

Anchor size	M8	M10	M12	M16	M20
Tensile, $N_{s,R}$	7.0	10.5	13.8	22.2	34.1
Combined load	8.5	12.9	17.3	30.0	46.5
Shear, $V_{s,R}$	21.1	19.5	24.8	37.7	58.0
	10.8	16.7	24.4	45.4	70.0

Recommended load for specific application

$$F_{s,R} = F_{ctd} \cdot A_{t,R}$$

f_{ctd} (kN): Load in different concrete strength

Anchor size	M8	M10	M12	M16	M20
Concrete, f_{ctd} (N/mm ²)	20	24	28	37.5	47.0
	20	25	30	40.0	50.0
	20	28	33	43.0	53.0
	20	30	35	45.0	55.0
	20	32	37	47.0	57.0
	20	34	39	49.0	59.0
	20	36	41	51.0	61.0
	20	38	43	53.0	63.0
	20	40	45	55.0	65.0
	20	42	47	57.0	67.0
	20	44	49	59.0	69.0
	20	46	51	61.0	71.0
	20	48	53	63.0	73.0
	20	50	55	65.0	75.0
	20	52	57	67.0	77.0
	20	54	59	69.0	79.0
	20	56	61	71.0	81.0
	20	58	63	73.0	83.0
	20	60	65	75.0	85.0
	20	62	67	77.0	87.0
	20	64	69	79.0	89.0
	20	66	71	81.0	91.0
	20	68	73	83.0	93.0
	20	70	75	85.0	95.0
	20	72	77	87.0	97.0
	20	74	79	89.0	99.0
	20	76	81	91.0	101.0
	20	78	83	93.0	103.0
	20	80	85	95.0	105.0
	20	82	87	97.0	107.0
	20	84	89	99.0	109.0
	20	86	91	101.0	111.0
	20	88	93	103.0	113.0
	20	90	95	105.0	115.0
	20	92	97	107.0	117.0
	20	94	99	109.0	119.0
	20	96	101	111.0	121.0
	20	98	103	113.0	123.0
	20	100	105	115.0	125.0
	20	102	107	117.0	127.0
	20	104	109	119.0	129.0
	20	106	111	121.0	131.0
	20	108	113	123.0	133.0
	20	110	115	125.0	135.0
	20	112	117	127.0	137.0
	20	114	119	129.0	139.0
	20	116	121	131.0	141.0
	20	118	123	133.0	143.0
	20	120	125	135.0	145.0
	20	122	127	137.0	147.0
	20	124	129	139.0	149.0
	20	126	131	141.0	151.0
	20	128	133	143.0	153.0
	20	130	135	145.0	155.0
	20	132	137	147.0	157.0
	20	134	139	149.0	159.0
	20	136	141	151.0	161.0
	20	138	143	153.0	163.0
	20	140	145	155.0	165.0
	20	142	147	157.0	167.0
	20	144	149	159.0	169.0
	20	146	151	161.0	171.0
	20	148	153	163.0	173.0
	20	150	155	165.0	175.0
	20	152	157	167.0	177.0
	20	154	159	169.0	179.0
	20	156	161	171.0	181.0
	20	158	163	173.0	183.0
	20	160	165	175.0	185.0
	20	162	167	177.0	187.0
	20	164	169	179.0	189.0
	20	166	171	181.0	191.0
	20	168	173	183.0	193.0
	20	170	175	185.0	195.0
	20	172	177	187.0	197.0
	20	174	179	189.0	199.0
	20	176	181	191.0	201.0
	20	178	183	193.0	203.0
	20	180	185	195.0	205.0
	20	182	187	197.0	207.0
	20	184	189	199.0	209.0
	20	186	191	201.0	211.0
	20	188	193	203.0	213.0
	20	190	195	205.0	215.0
	20	192	197	207.0	217.0
	20	194	199	209.0	219.0
	20	196	201	211.0	221.0
	20	198	203	213.0	223.0
	20	200	205	215.0	225.0
	20	202	207	217.0	227.0
	20	204	209	219.0	229.0
	20	206	211	221.0	231.0
	20	208	213	223.0	233.0
	20	210	215	225.0	235.0
	20	212	217	227.0	237.0
	20	214	219	229.0	239.0
	20	216	221	231.0	241.0
	20	218	223	233.0	243.0
	20	220	225	235.0	245.0
	20	222	227	237.0	247.0
	20	224	229	239.0	249.0
	20	226	231	241.0	251.0
	20	228	233	243.0	253.0
	20	230	235	245.0	255.0
	20	232	237	247.0	257.0
	20	234	239	249.0	259.0
	20	236	241	251.0	261.0
	20	238	243	253.0	263.0
	20	240	245	255.0	265.0
	20	242	247	257.0	267.0
	20	244	249	259.0	269.0
	20	246	251	261.0	271.0
	20	248	253	263.0	273.0
	20	250	255	265.0	275.0
	20	252	257	267.0	277.0
	20	254	259	269.0	279.0
	20	256	261	271.0	281.0
	20	258	263	273.0	283.0
	20	260	265	275.0	285.0
	20	262	267	277.0	287.0
	20	264	269	279.0	289.0
	20	266	271	281.0	291.0
	20	268	273	283.0	293.0
	20	270	275	285.0	295.0
	20	272	277	287.0	297.0
	20	274	279	289.0	299.0
	20	276	281	291.0	301.0
	20	278	283	293.0	303.0
	20	280	285	295.0	305.0
	20	282	287	297.0	307.0
	20	284	289	299.0	309.0
	20	286	291	301.0	311.0
	20	288	293	303.0	313.0
	20	290	295	305.0	315.0
	20	292	297	307.0	317.0
	20	294	299	309.0	319.0
	20	296	301	311.0	321.0
	20	298	303	313.0	323.0
	20	300	305	315.0	325.0
	20	302	307	317.0	327.0
	20	304	309	319.0	329.0
	20	306	311	321.0	331.0
	20	308	313	323.0	333.0
	20	310	315	325.0	335.0
	20	312	317	327.0	337.0
	20	314	319	329.0	339.0
	20	316	321	331.0	341.0
	20	318	323	333.0	343.0
	20	320	325	335.0	345.0
	20	322	327	337.0	347.0
	20	324	329	339.0	349.0
	20	326	331	341.0	351.0
	20	328	333	343.0	353.0
	20	330	335	345.0	355.0
	20	332	337	347.0	357.0
	20	334	339	349.0	359.0
	20	336	341	351.0	361.0
	20	338	343	353.0	363.0
	20	340	345	355.0	365.0
	20	342	347	357.0	367.0
	20	344	349	359.0	369.0
	20	346	351	361.0	371.0
	20	348	353	363.0	373.0
	20	350	355	365.0	375.0
	20	352	357	367.0	377.0
	20	354	359	369.0	379.0
	20	356	361	371.0	381.0
	20	358	363	373.0	383.0
	20	360	365	375.0	385.0
	20	362	367	377.0	387.0
	20	364	369	379.0	389.0
	20	366	371	381.0	391.0
	20	368	373	383.0	393.0
	20	370	375	385.0	395.0
	20	372	377	387.0	397.0
	20	374	379	389.0	399.0
	20	376	381	391.0	401.0
	20	378	383	393.0	403.0
	20	380	385	395.0	405.0
	20	382	387	397.0	407.0
	20	384	389	399.0	409.0
	20	386	391	401.0	411.0
	20	388	393	403.0	413.0
	20	390	395	405.0	415.0
	20	392	397	407.0	417.0
	20	394	399	409.0	419.0
	20	396	401	411.0	421.0
	20	398	403	413.0	



HSL-G-R heavy-duty anchor

Setting details

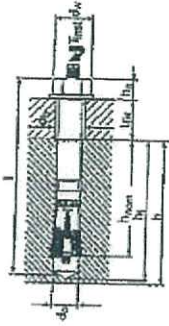

HSL-G-R

Setting Details		M 20/0	M 20/40	M 10/20	M 10/40	M 12/25	M 12/50	M 16/50	M 16/75	M 20/30	M 20/60
d_b (mm)	Drill bit diameter	12	15	15	18	24	24	24	24	28	28
d (mm)	Hole diameter	80	90	90	100	125	125	125	125	135	135
h (mm)	Hole depth	80	100	100	100	105	105	105	105	130	130
l (mm)	Max. failure depth	20	40	20	40	25	40	25	40	30	30
l_a (mm)	Max. failure thickness	102	122	115	135	120	150	157	157	150	150
l_c (mm)	Anchor length	9.5	12.0	15.0	15.0	19.0	22.0	22.0	22.0	22.0	22.0
T (mm)	Head height + washer	25	40	40	40	40	40	40	40	40	40
S (mm)	Width across flts	4	5	5	8	8	8	8	8	8	8
c (mm)	Clearance hole	13	17	17	19	24	24	24	24	30	30
d_w (mm)	Washer diameter	20	25	25	30	30	30	30	30	40	40
h (mm)	Min. base material thickness	120	140	140	160	160	160	160	160	160	160
Drill bit	TE-C34	1222	1527	1527	1832	2432	2432	2432	2432	2532	2532
Drill bit	TE-T	-	-	-	-	-	-	-	-	-	-

Installation equipment

Rotary hammer (TE1, TE2, TE5, TE6, TE6A, TE15, TE15-C, TE18-M, TE35, TE56, TE76), a hammer and a torque wrench.

Setting operations

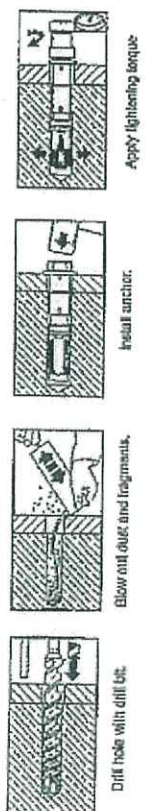

HSL-G-R heavy-duty anchor

Anchor mechanical properties

Anchor size	HSL-G-R	M 8	M 10	M 12	M 16	M 20
f_{tk} (N/mm ²)	Normal tensile strength	700	700	700	700	700
f_{yk} (N/mm ²)	Yield strength	480	480	480	480	480
A_k (mm ²)	Stressed cross-section	36.6	59.0	84.3	157	245
W_k (Nm ²)	Elastic moment of resistance	106	231	390	966	1421
M_k (Nm)	Design bending moment	41	80	130	376	550

**VIEW A -
GMS FRAME WITH
SCREEN GUIDE**
SCALE 1 : 50 (A3)

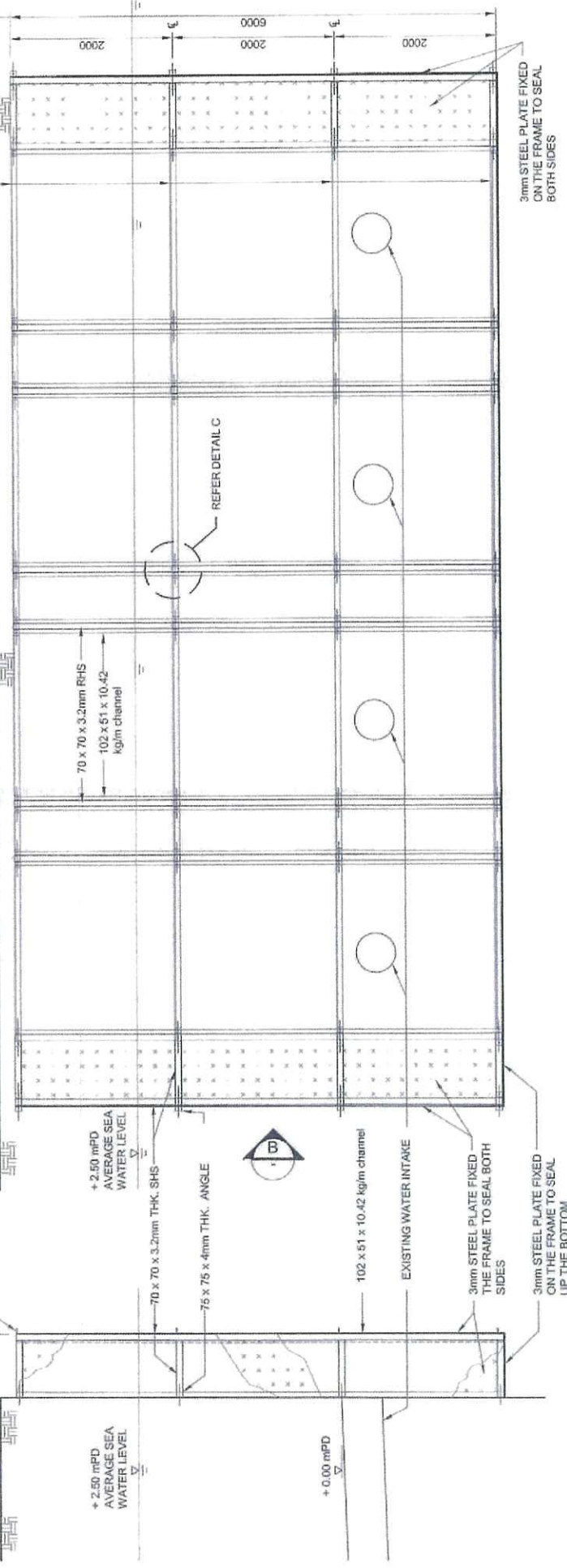
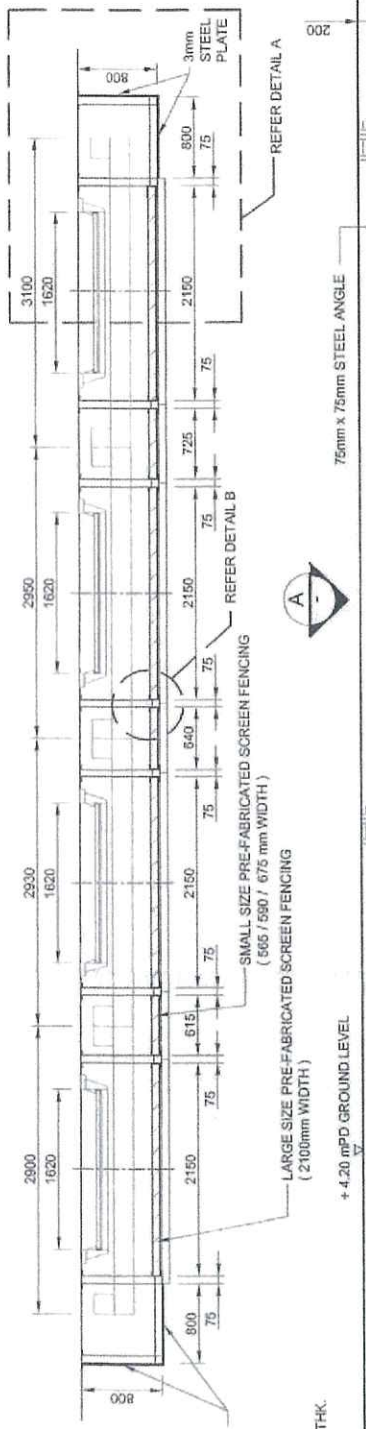

VIEW B
SCALE 1 : 50 (A3)

PRE-FABRICATED WALL MOUNTED FRAME FOR THE SILT SCREEN
SCALE 1 : 50 (A3)

CLIENT CEDD Civil Engineering and Development Department	CONTRACTOR 俊和 - 中國 中鐵聯營 CHUN WO - CRGL JOINT VENTURE	JOB TITLE: PROPOSED WSD INTAKE COVER		SCALE AS SHOWN (A3)	REF. TO Dwg. NO. CW-CR/ENG/ENG-0105-R013
		ENGINEERS REPRESENTATIVE AECOM	PROJECT: WAN CHAI DEVELOPMENT PHASE II - CENTRAL - WAN CHAI BYPASS AT WAN CHAI EAST (HK200902)	DATE 30 MAR 2010	Sheet of
				DRAWN M.S. SN	DESIGNED
				CHECKED	APPROVED
				SKETCH NO. CWCRJW/HK200902/SK0022	REV A

NOTE:
DIMENSION OF THE PRE-FABRICATED
FRAME COULD BE ADJUSTED TO SUIT THE
ACTUAL SIZE OF EACH WATER INTAKE.

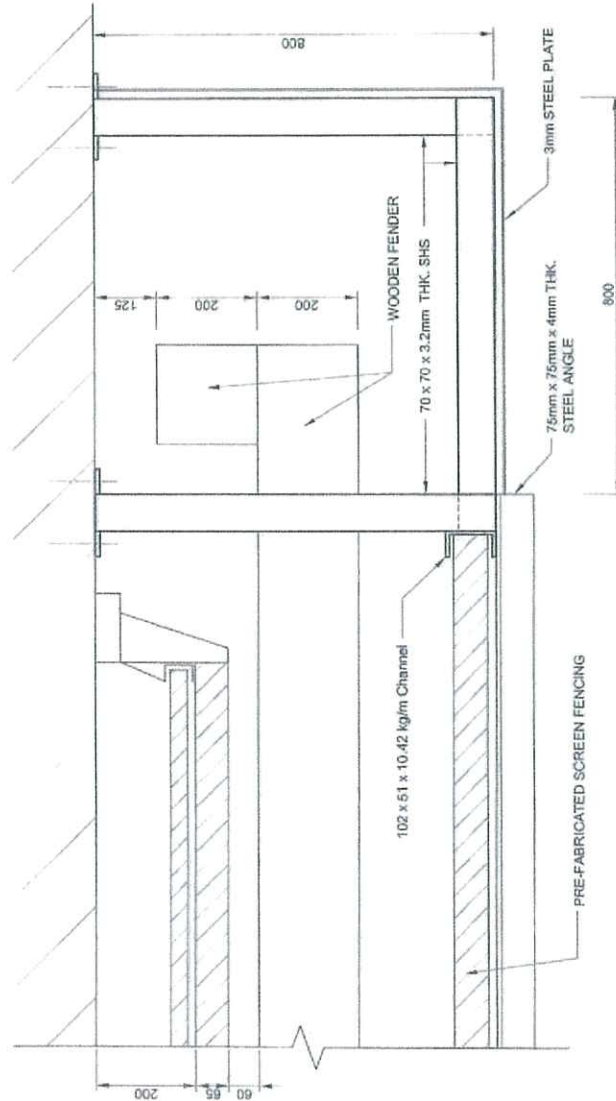

DETAIL A
SCALE 1 : 10 (A3)

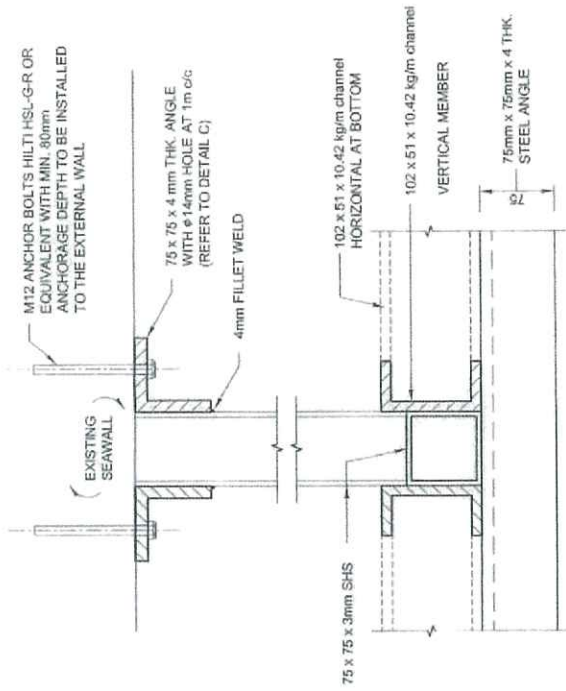

DETAIL B
SCALE 1 : 5 (A3)

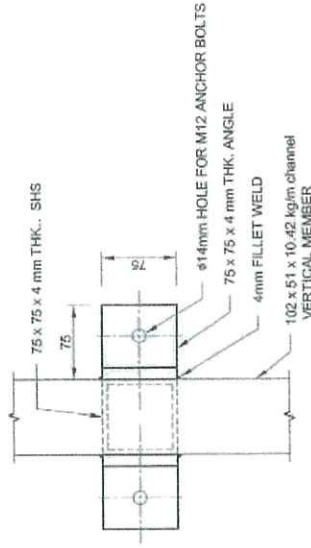

DETAIL C
SCALE 1 : 5 (A3)

CHINA 土木工程師事務所 CEDD Civil Engineering and Development Department AECOM ENGINEER'S REPRESENTATIVE	後和 - 中國中鐵聯營 CHEUN WO - CCKGL JOINT VENTURE PROJECT: WAN CHAI DEVELOPMENT PHASE II - CENTRAL - WAN CHAI BYPASS AT WAN CHAI EAST (HK200902)	JOB TITLE: FIXING DETAILS OF THE WALL MOUNTED STEEL FRAME TO THE EXTERNAL WALL OF WSD PUMP STATION INTAKES	
		AS SHOWN (A3) DATE: 30 MAR 2010 DRAWN: M.S. SIN CHECKED: - DESIGNED: - APPROVED: -	REF TO DNO NO. CW-CR/ENG/ENG-0106-R014 SKETCH NO. CWCRJV/HK200902/SY0023
SCALE DATE DRAWN CHECKED	REF TO DNO NO. SKETCH NO.	SHEET NO. of	REV A

NOTE:
ALL CONNECTION OF STEEL MEMBER BY
4mm FILLET WELD UNLESS OTHERWISE
STATED.

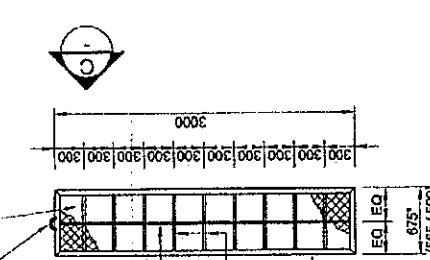
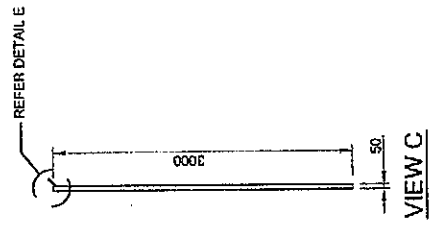

PRE-FABRICATED SILT SCREEN FENCING
(565 / 590 / 675mm WIDTH)
SCALE 1 : 50 (A3)

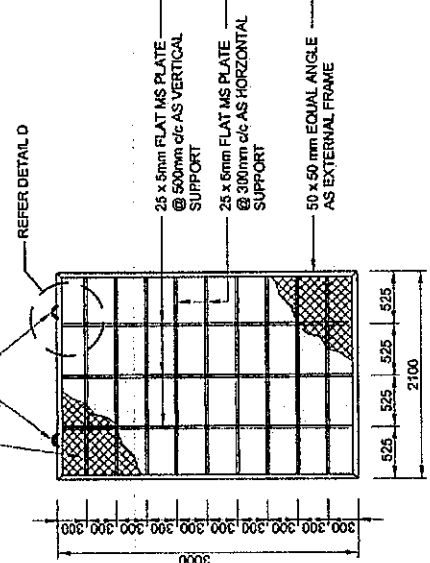

PRE-FABRICATED SILT SCREEN FENCING
(2100mm WIDTH) SCALE 1 : 50 (A3)

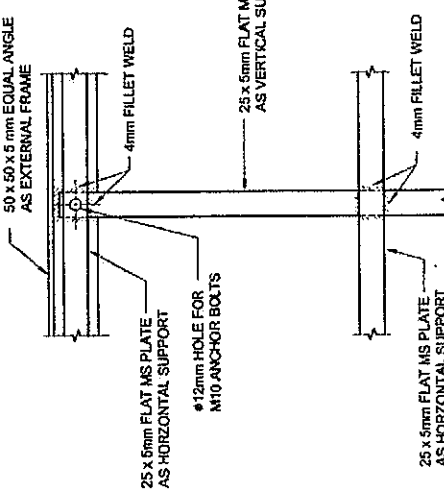

DETAIL D
SCALE 1 : 5 (A3)

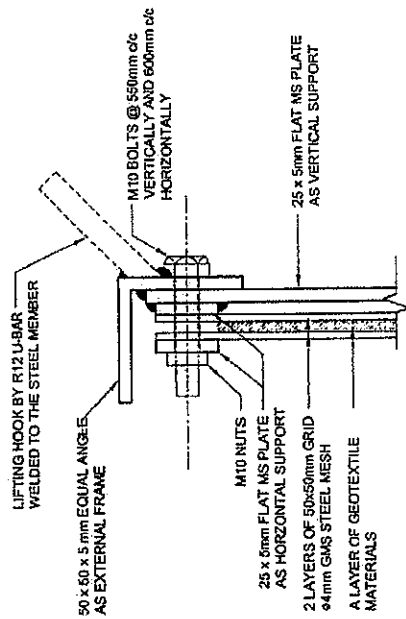

DETAIL E
SCALE 1 : 2 (A3)

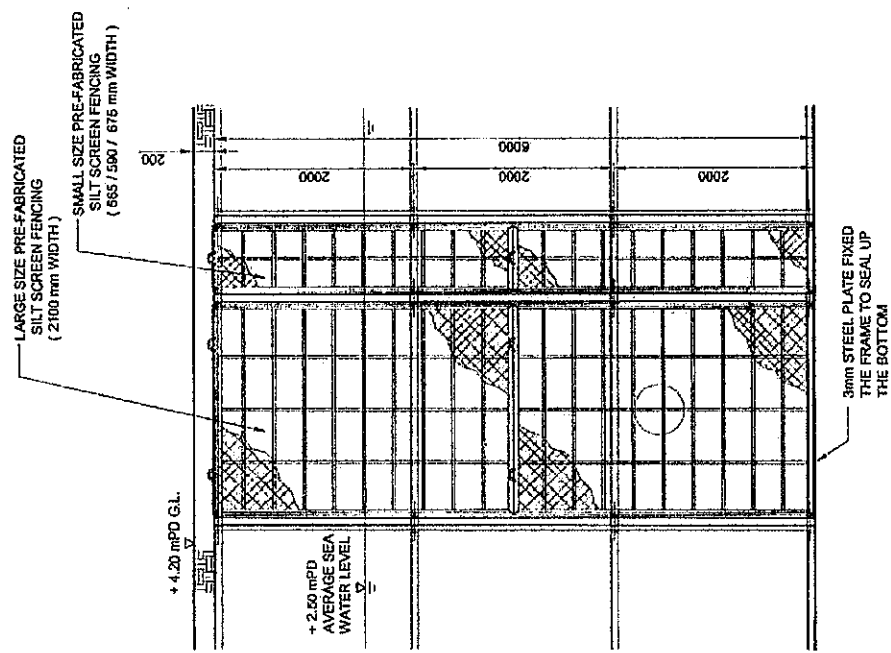

TYPICAL ARRANGEMENT OF SILT SCREEN FENCING
INSTALLATION INTO THE WALL MOUNTED FRAME
SCALE 1 : 50 (A3)

CURT 土木工務部 CEDD Civil Engineering and Development Department	CONTRACTOR 俊和 - 中國中鐵聯營 CHUN WO - CRGI JOINT VENTURE	SCALE AS SHOWN (A3)	SEC. TO DING NO. 30 MAR 2010	CW-CR/ENG/ENG-0107-R015
		DATE 30 MAR 2010	SHEET NO. SKETCH NO. CWCRCJY/HK200902/SK0024	REV A
ENGINEER REPRESENTATIVE AECOM	PROJECT WAN CHAI DEVELOPMENT PHASE II - CENTRAL - WAN CHAI BYPASS AT WAN CHAI EAST. (HK200902)	JOB TITLE PROPOSED PRE-FABRICATED SILT SCREEN FENCING AND THE TYPICAL ARRANGEMENT FOR ITS INSTALLATION INTO THE WALL MOUNTED FRAME	DRAWN U.S. SIN	DESIGNED
		CHECKED -	APPROVED	

NOTE:
DIMENSION OF THE PRE-FABRICATED
FRAME SHOULD BE ADJUSTED TO SUIT THE
ACTUAL SIZE OF EACH WATER INTAKE.

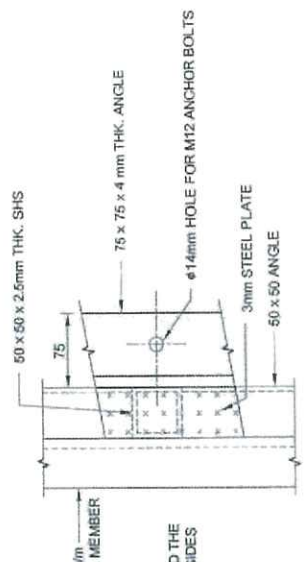
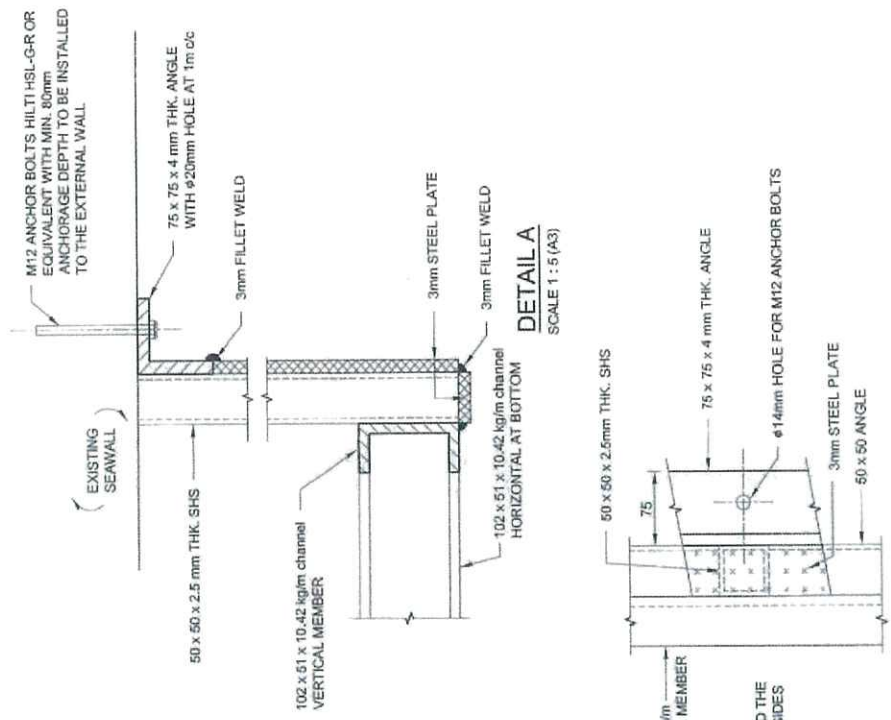
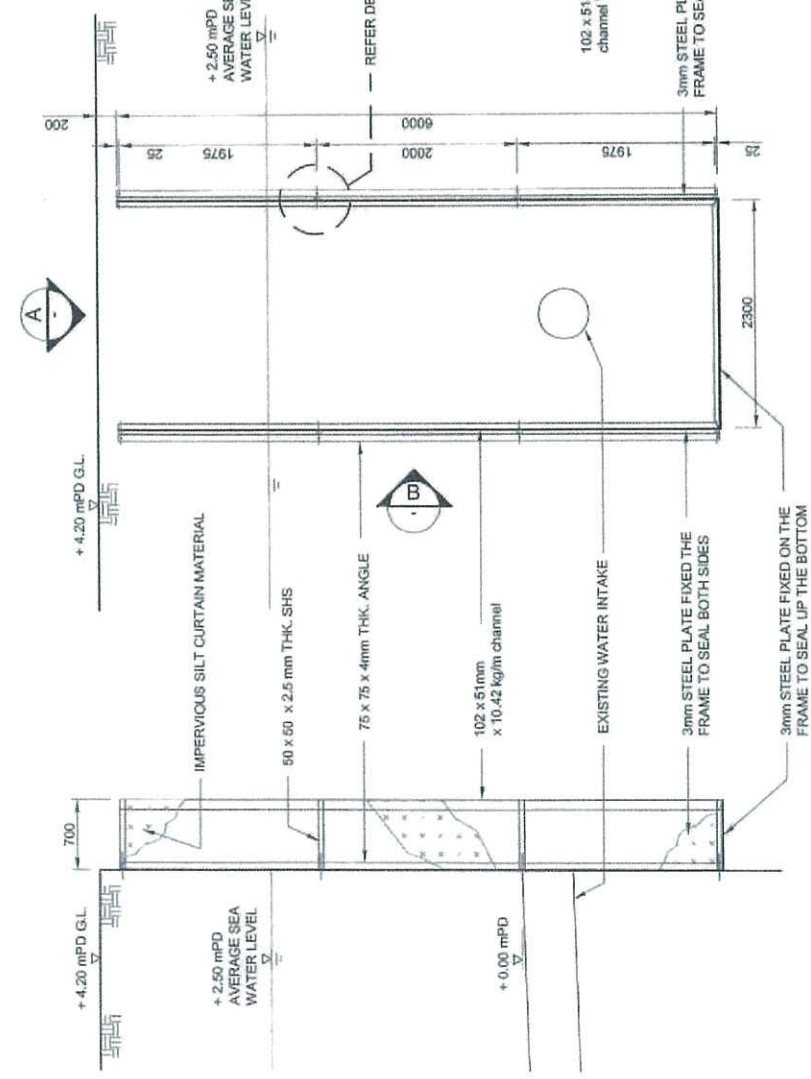
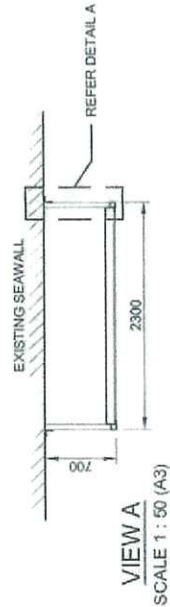

**PRE-FABRICATED WALL MOUNTED FRAME
FOR THE SILT SCREEN**
SCALE 1 : 50 (A3)

DETAIL B
SCALE 1 : 5 (A3)

CLIENT CEDD Civil Engineering and Development Department	CONTRACTOR 後和 - 中國中鐵聯響 CHUN WO - CRGL JOINT VENTURE	SCALE	AS SHOWN (A3)	REF. TO DWG NO.	CW-CRENGSK-SK0025
		DATE	11 MAR 2010	SHEET NO	of
ENGINEERS REPRESENTATIVE AECOM	PROJECT CONTRACT NO. HKZ000/02 WAN CHAI DEVELOPMENT PHASE II - CENTRAL - WAN CHAI BYPASS AT WAN CHAI EAST	DRAWN	M5 SIN	DESIGNED	SKETCH NO
		CHECKED		APPROVED	CWCRU/WHK200802SK0025
JOB TITLE FIXING DETAILS OF THE WALL MOUNTED STEEL FRAME TO THE EXTERNAL WALL OF SUN HUNG KEI PUMP STATION INTAKES		REV	A		

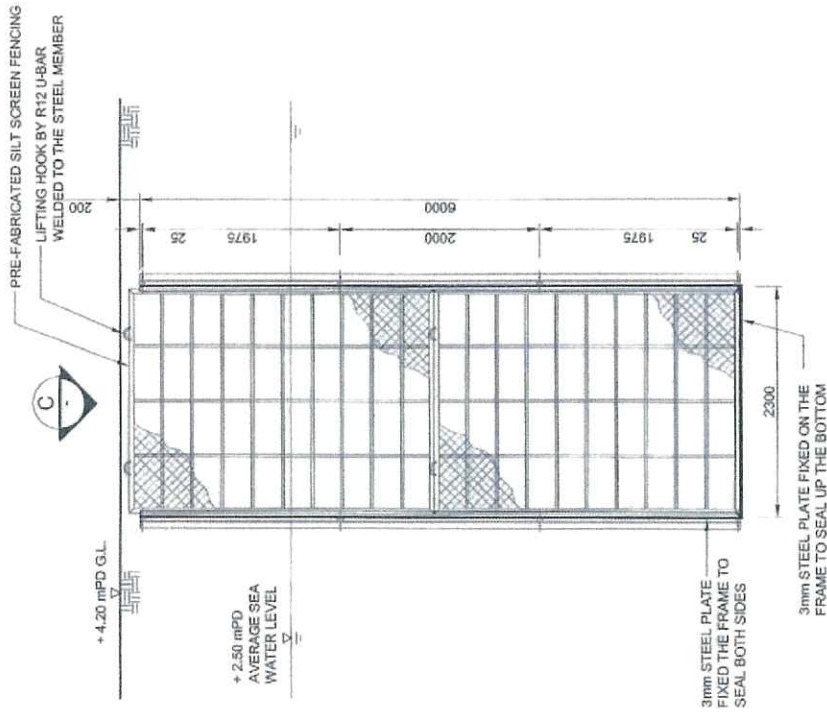
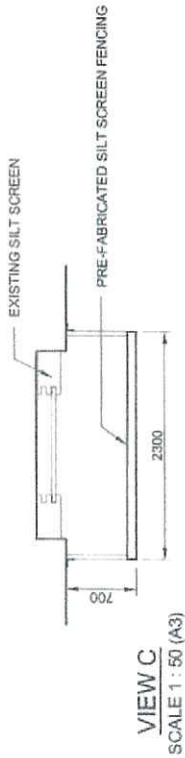

**TYPICAL ARRANGEMENT OF SILT SCREEN FENCING
INSTALLATION INTO THE WALL MOUNTED FRAME**
SCALE 1 : 50 (A3)

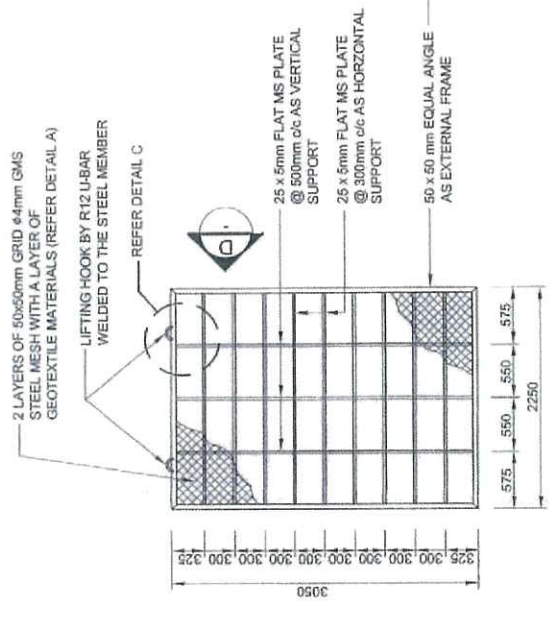

PRE-FABRICATED SILT SCREEN FENCING
SCALE 1 : 50 (A3)

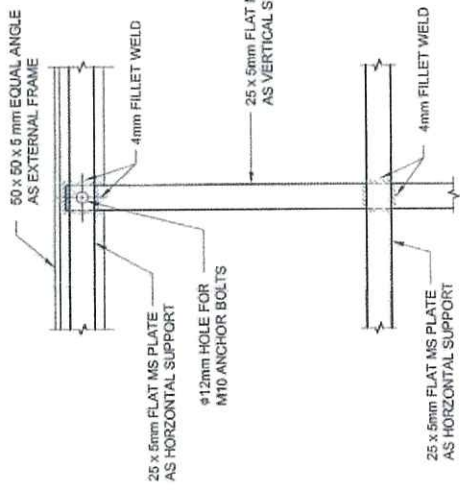

DETAIL C
SCALE 1 : 5 (A3)

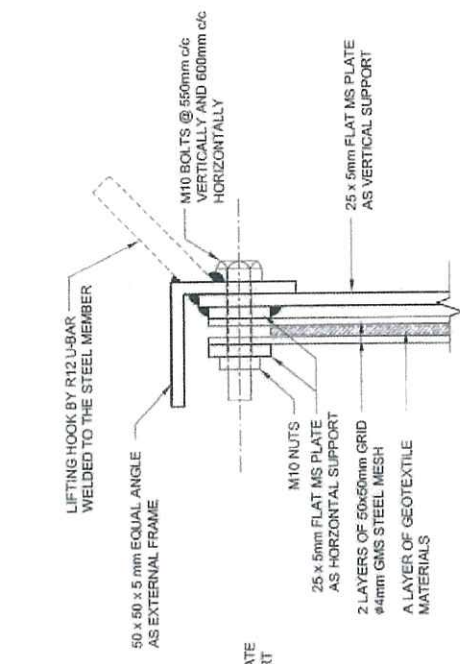

DETAIL D
SCALE 1 : 2 (A3)

NOTE:
ALL CONNECTION OF STEEL MEMBER BY
4mm FILLET WELD UNLESS OTHERWISE
STATED.

CONTRACTOR 土木工程有限公司 CDD Civil Engineering and Development Department	CONTRACTOR 後和 - 中國中鐵聯營 CHUN WO - CCKL JOINT VENTURE	REF. TO DWG NO.	CH-CRENGS/SK-SK0026
		SCALE	AS SHOWN (A3)
PROJECT CONTRACT NO. HKZ00802 WAN CHAI DEVELOPMENT PHASE II - CENTRAL - WAN CHAI BYPASS AT WAN CHAI EAST	PROJECT 後和 - 中國中鐵聯營 CHUN WO - CCKL JOINT VENTURE	DATE	11 MAR 2010
		DRAWN	M.S. SIN
		DESIGNED	DESIGNED
ENGINEER'S REPRESENTATIVE AECOM	ENGINEER'S REPRESENTATIVE 	CHECKED	XXXX
		APPROVED	APPROVED
JOB TITLE: PROPOSED PRE-FABRICATED SILT SCREEN FENCING AND THE TYPICAL ARRANGEMENT FOR ITS INSTALLATION INTO THE WALL MOUNTED FRAME		SHEET NO.	of
SKETCH NO. CHC/RU/WH/200802/SK0026		REV	A



俊和－中國中鐵聯營

CHUN WO – CRGL JOINT VENTURE

Contract No. HK/2009/02

Wan Chai Development Phase II

Central – Wan Chai Bypass at Wan Chai East

Silt Screen Deployment Plan

Appendix C

Graphical Illustration for the Installations of the Silt Screen System

Graphical Illustration for Installation of Wall Mounted Frame

1. Switch off the relevant intake pump
2. Lift the pre-fabricated steel frame to the required position

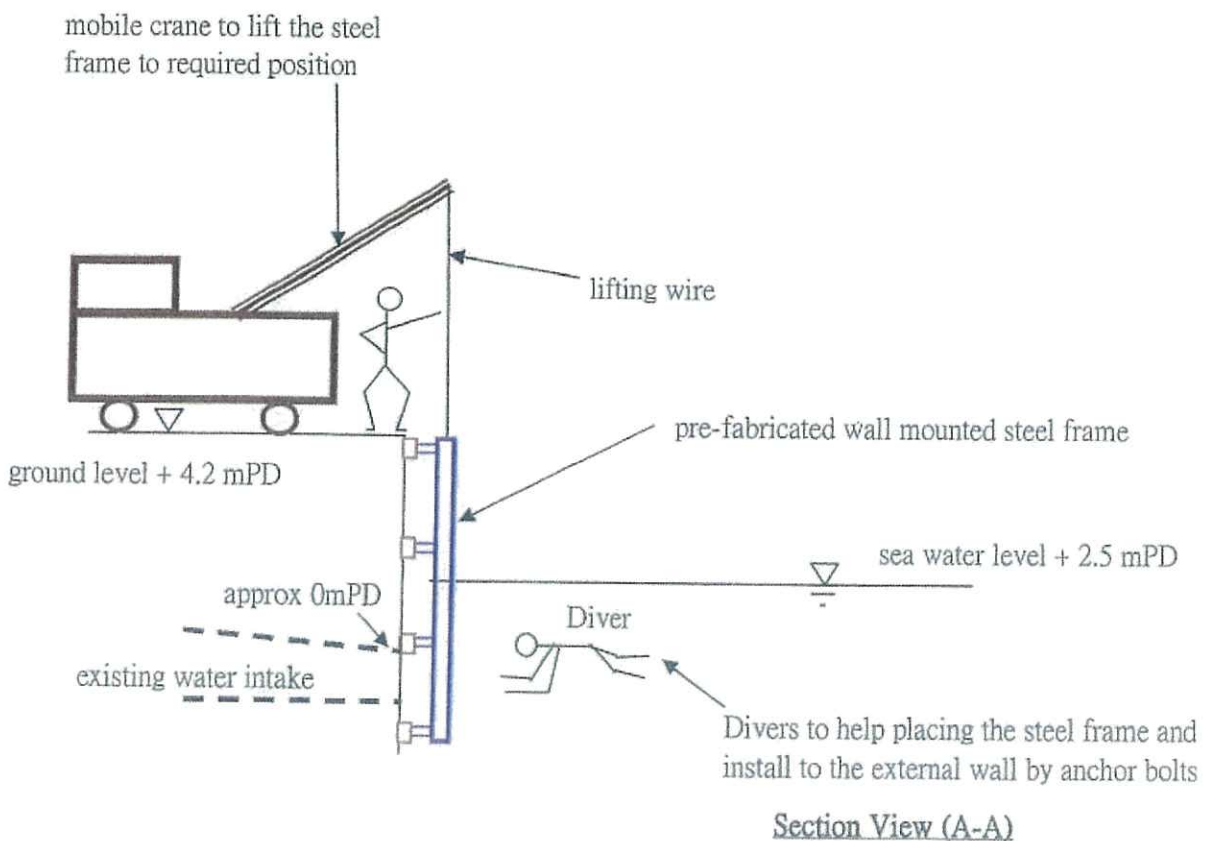
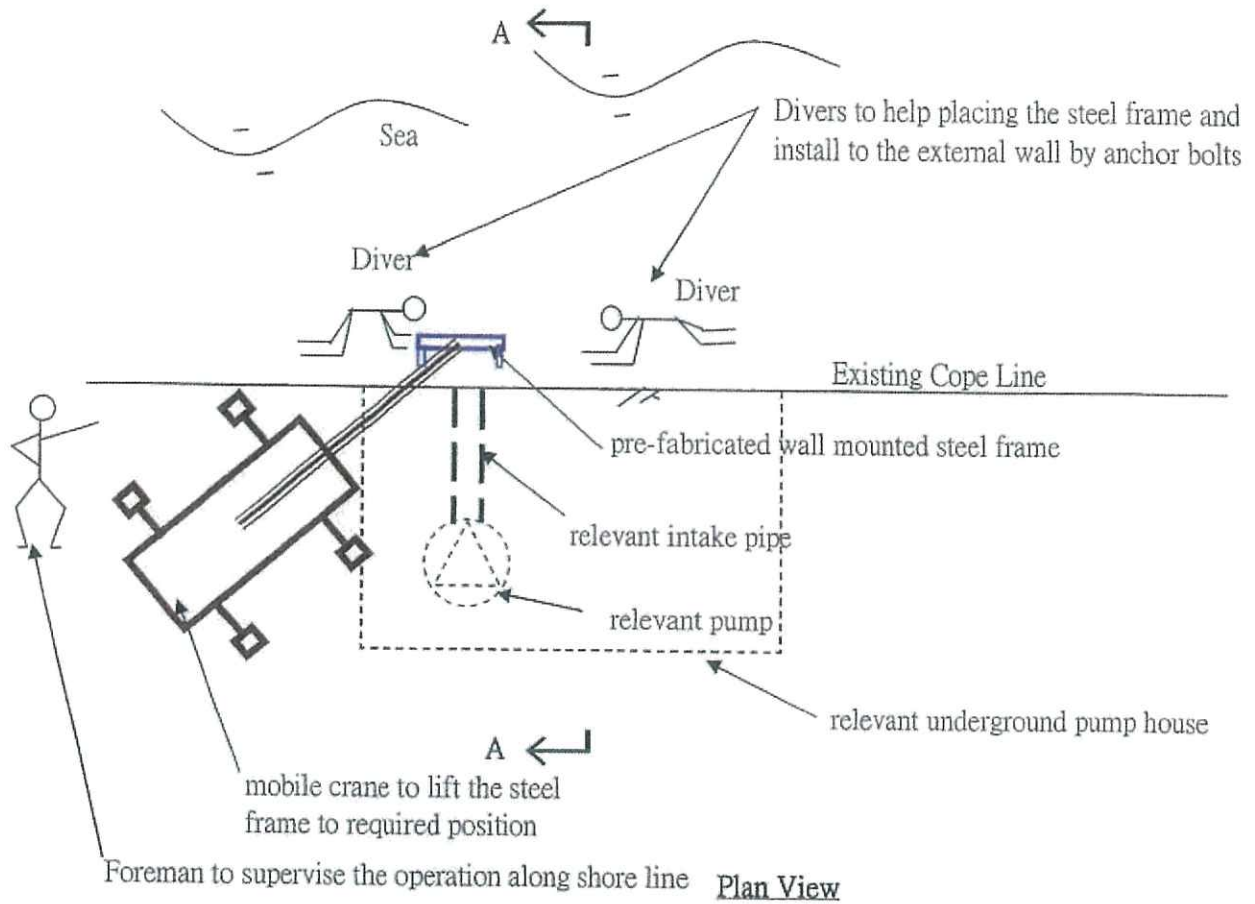

Graphical Illustration for Installation of Wall Mounted Frame

3. Drill holes to the external wall by pneumatic air driller and install Hilti type HSL-3 bolts

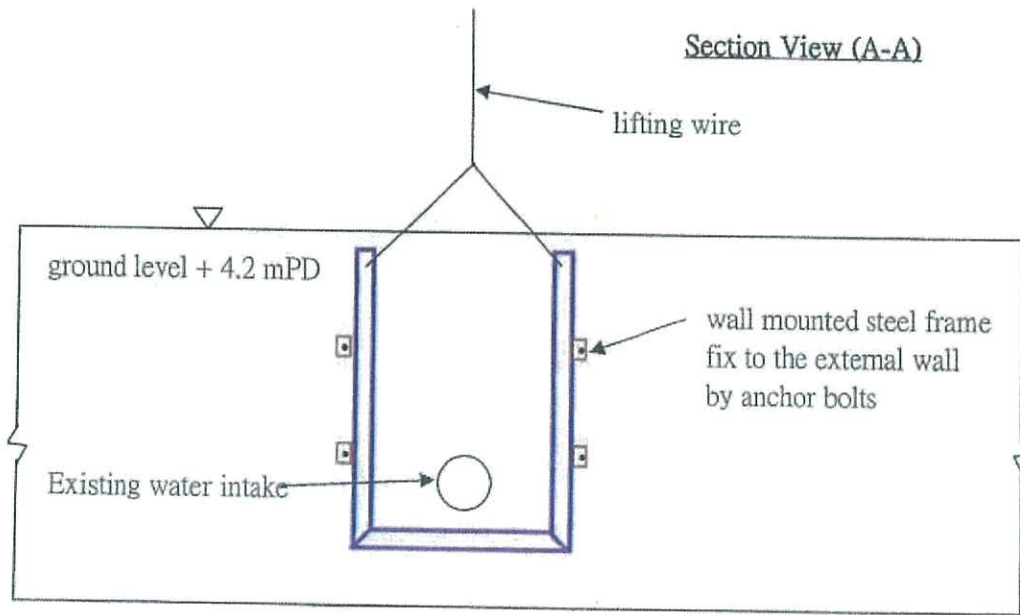
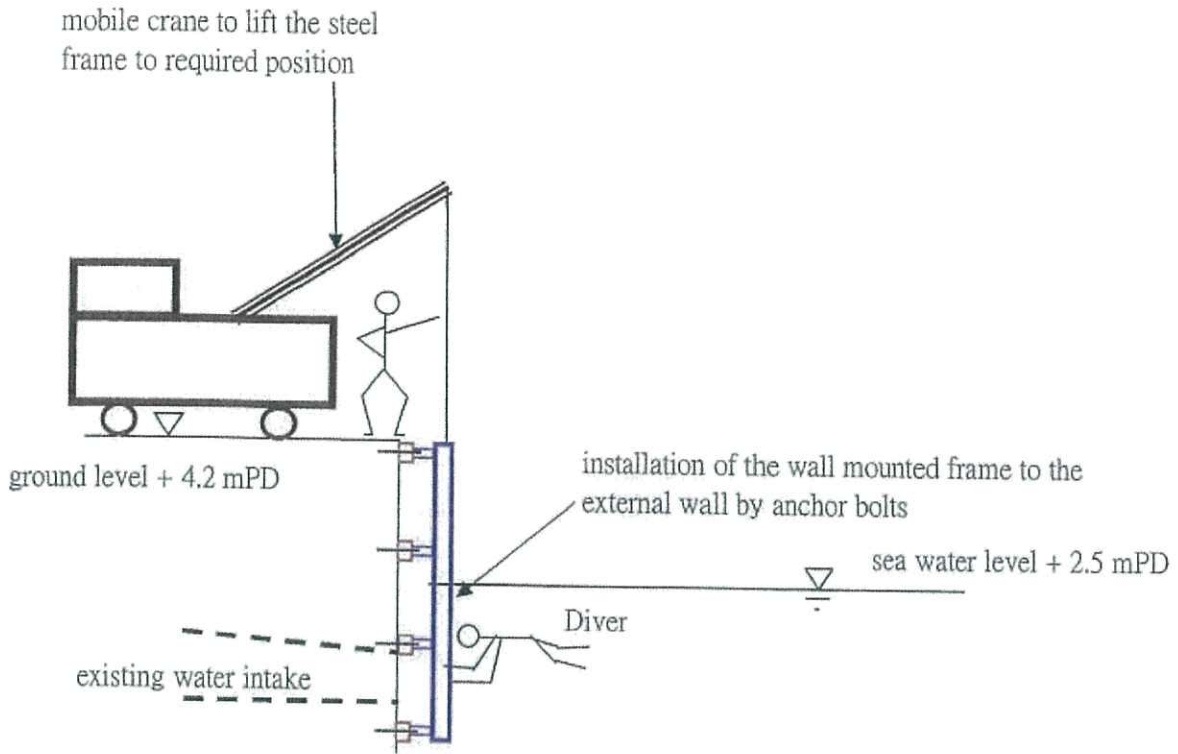

Elevation View

Graphical Illustration for Installation of the Silt Screen Fencing

1. Swith off the relevant intake pump
2. Lift the pre-fabricated silt screen fencing (bottom piece) to the required position and insert into the frame
3. Maintain a steel wire at the lifting eye of the steel fence and bring it to ground
4. Lift the other piece of pre-fabricated silt screen fencing (upper piece) and insert into the wall mounted frame
5. Maintain another piece of steel wire at the lifting eye of the steel fence and bring it to ground
6. Tie the two piece of steel wire properly at existing lifting arm of the pump house for ease of later maintenance use
7. Later maintenance would be carried out by lifting up the steel fencing by using typical chain block pulley system

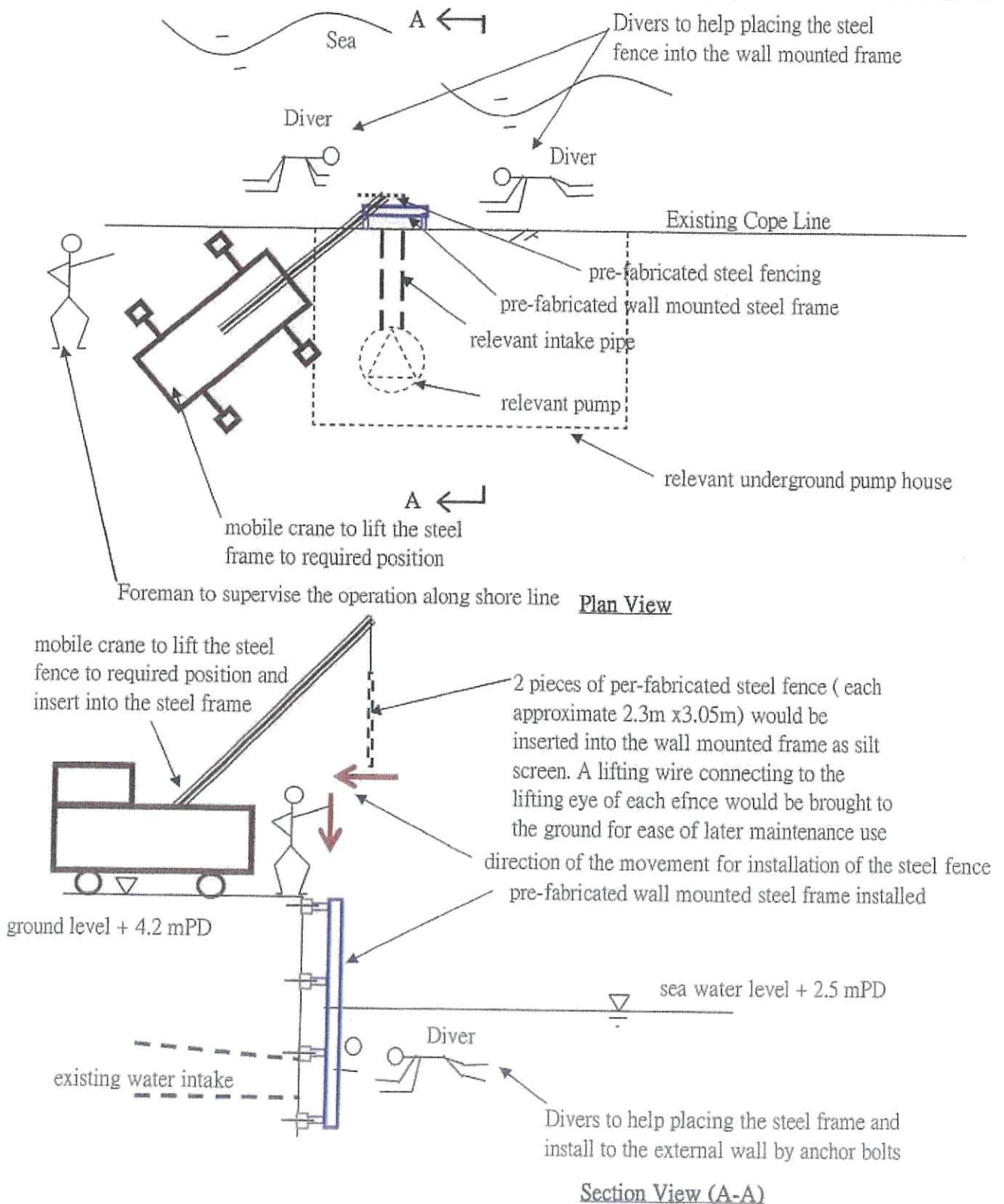

Graphical Illustration for Installation of double-layer silt curtain

1. Clean up the floation debris
2. Tug the double-layer silt curtain screen to designated location

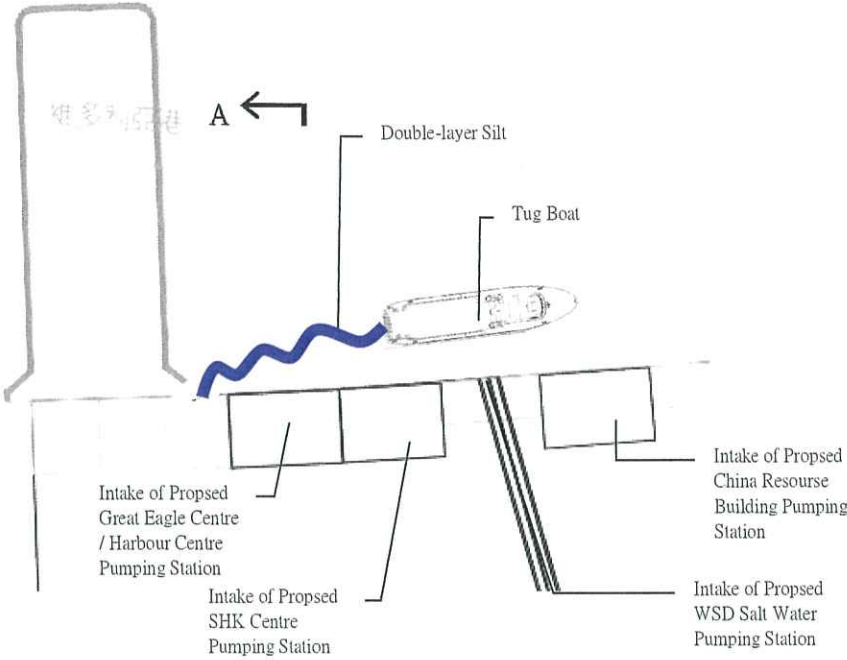

A ←

Plan View

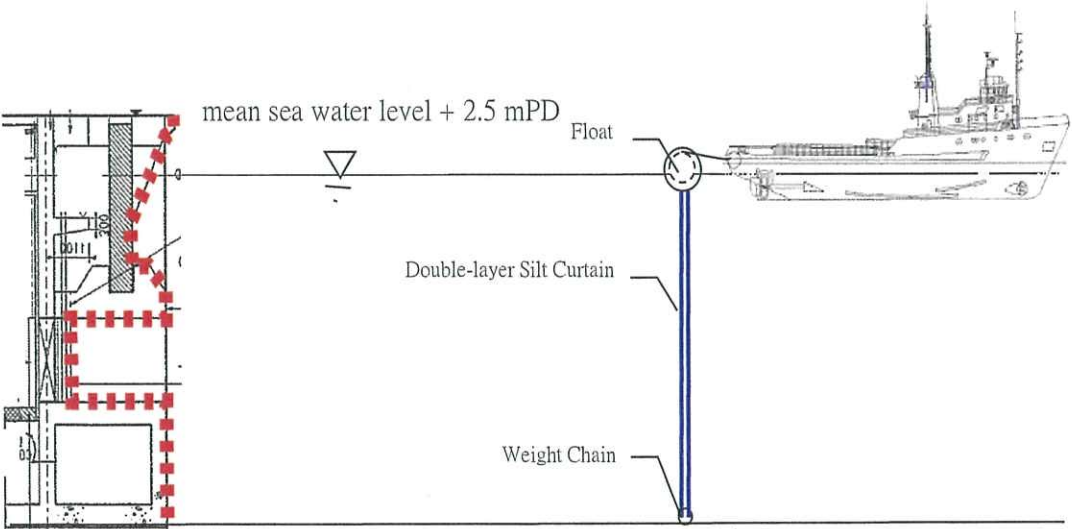

Sectional View A-A

Graphical Illustration for Removal of double-layer silt curtain

1. Tug the double-layer silt curtain screen away from intakes

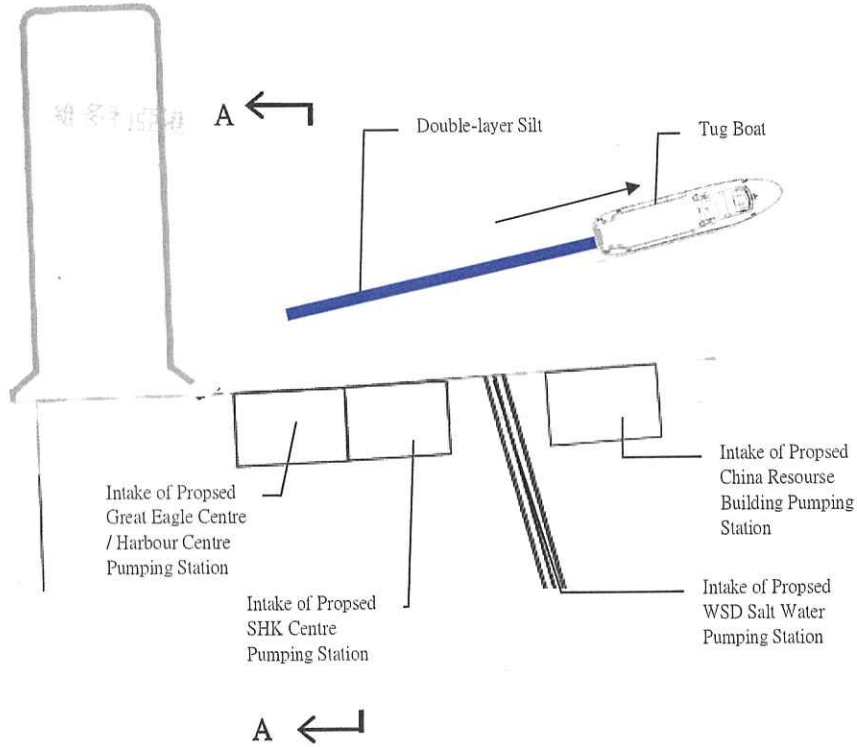

Plan View

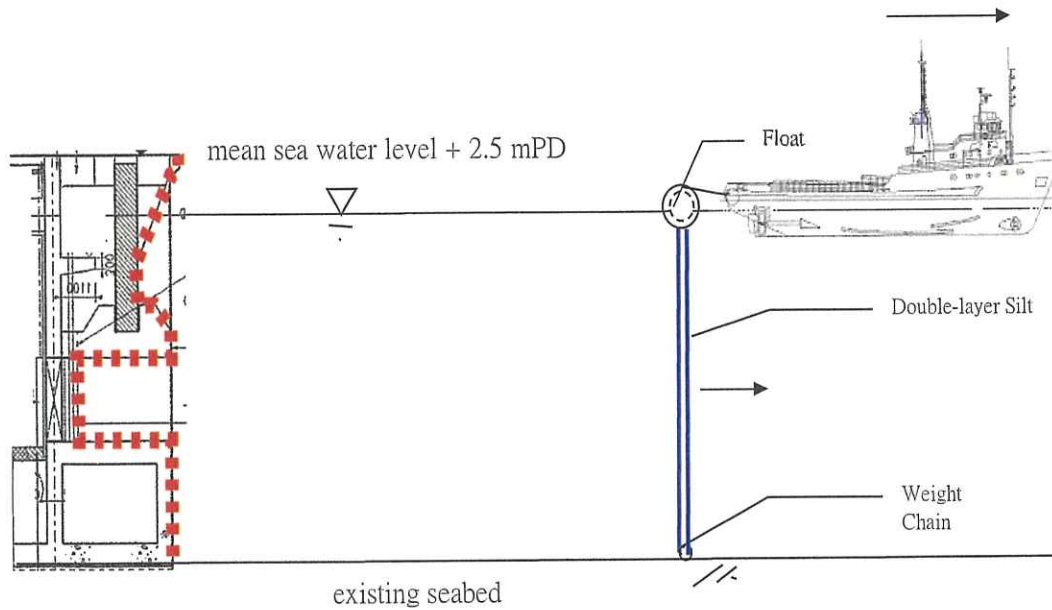

Sectional View A-A



俊和 - 中國中鐵聯營

CHUN WO - CRGL JOINT VENTURE

Contract No. HK/2009/02

Wan Chai Development Phase II

Central - Wan Chai Bypass at Wan Chai East

Silt Screen Deployment Plan

Appendix D

Daily Inspection Checklist



俊和 - 中國中鐵聯營
CHUN WO - CRGL JOINT VENTURE

Contract No. HK/2009/02

Contract Title Wan Chai Development Phase II - Central - Wan Chai By Pass at Wan Chai East

Silt Curtain每日檢查表

說明： ✓ = 滿意
 × = 不滿意，須改善
 - = 不適用

位置：_____

日期：_____ 檢查員：_____

	星 期 一	星 期 二	星 期 三	星 期 四	星 期 五	星 期 六	星 期 日
整潔							
1. 沒有垃圾在架內 <i>不用</i>							
2. 沒有泥水在架內							
3. 已清理架內垃圾 <i>已清理</i>							
其他問題(請註明)：							
鐵架狀況							
1. 鐵架沒有損壞							
2. 鐵網沒有損壞							
3. 繫緊螺絲沒有鬆脫							
其他問題(請註明)：							
隔泥布狀況							
1. 隔泥布沒有損壞							
2. 沒有隔泥布在業主的隔泥網上							
3. 隔泥布沒有鬆脫							
其他問題(請註明)：							
簽署：							

RSS: _____



俊和 - 中國中鐵聯營

CHUN WO - CRGL JOINT VENTURE

Contract No. HK/2009/02

Wan Chai Development Phase II

Central - Wan Chai Bypass at Wan Chai East

Silt Screen Deployment Plan

Appendix E

Technical Properties of the Geotextile Material – Tencate Mirafi FW300

Mirafi® FW Woven Filter Geotextiles

Properties of Mirafi® FW Woven Filter Geotextiles						
Property	Unit	FW300	FW400	FW482	FW404	FW708
Mechanical properties						
Wide width tensile strength ISO 10319, ASTM D4595						
Mean tensile strength	MD kN/m	45	35	45	45	45
Mean tensile strength	CD kN/m	45	35	30	45	30
Grab tensile strength ASTM D4632						
Mean tensile strength	MD kN	1.8	1.4	1.6	1.9	1.7
Mean tensile strength	CD kN	1.5	1.2	0.9	1.5	1.1
Extension at peak strength	MD %	20	20	25	20	25
Extension at peak strength	CD %	20	20	20	20	20
CBR puncture strength ISO 12236, ASTM D6241						
Mean puncture strength	kN	5.5	4.5	3.0	5.5	4.5
UV resistance after 500 hrs ASTM D4355						
Strength retention	%	90	90	90	90	90
Hydraulic properties						
Characteristic opening size ISO 12956						
O_{10}	mm	0.35	0.30	0.25	0.20	0.20
Percent open area GOE-22125*86						
POA	%	10	10	10	-	-
Water permeability ISO 11058						
Mean flow rate, Q_{50}	$l/m^2/s$	90	50	100	45	20
Mean permittivity, ψ	s^{-1}	1.8	1.0	2.0	0.9	0.4
Mean permeability/velocity index, k_v	cm/s	0.15	0.04	0.15	0.08	0.02
Nominal roll width	m	4.0	4.0	4.0	4.5	3.8
Nominal roll length	m	100	100	100	100	100
Estimated roll weight	kg	110	75	85	130	80

* The mean flow rate is $90/m^2/s$ which is capable to allow normal operations of the pump houses.

Mirafi® is a registered trademark of Royal Ten Cate. The information contained herein is to the best of our knowledge accurate, but since the circumstances and conditions in which it may be used are beyond our control we do not accept any liability for any loss or damage, however arising, which results directly or indirectly from use of such information nor do we offer any warranty or immunity against patent infringement.

Ten Cate Industrial Zhuhai Co., Ltd.
South of Nengang West Road,
Gaolan Port Economic Zone, Zhuhai 519050, China
Tel: +86 756 886 1816, Fax: +86 755 066 1610
Email: info.zhuhai@tencate.com

Ten Cate Geotextiles Asia Sdn. Bhd.
14, Jalan Somenia 27/51, Seksyen 27,
40400 Shah Alam, Selangor Darul Ehsan, Malaysia
Tel: +60 3 5182 8560, Fax: +60 3 5192 8575
Email: info.asia@tencate.com

TENCATE
materials that make a difference



FILTRATION



SEPARATION



EROSION PROTECTION

Mirafi™ FW-Series Woven Geotextiles for Engineered Filtration

TenCate™ develops and produces materials that function to increase performance, reduce costs and deliver measurable results by working with our customers to provide advanced solutions.

The Difference Mirafi™ FW-Series Engineered Filtration Geotextiles Make:

- **Engineered Filtration.** Resists clogging while maintaining flow rates in high gradient and dynamic flow conditions.
- **Durability.** High survivability rating in aggressive installation and loading conditions along with excellent resistance to chemicals in aggressive environments.
- **Soil Interaction.** Superior soil confinement resulting in greater load distribution.
- **Unique Constructions.** Manufactured with highly UV stabilized monofilament and multifilament fibers which provide highly uniform opening size (AOS) while maintaining high long-term flow rates. Mirafi™ FW-Series geotextiles are manufactured with highly specialized processes to produce unique physical and hydraulic properties not possible with standard geotextiles, woven or nonwoven.

- **Seams.** Panels can be sewn together in the factory or field, providing cross-roll direction strength to facilitate installation.

APPLICATIONS

Mirafi™ FW-Series engineered filtration geotextiles are designed for long-term performance in problematic soil or site conditions to ensure clogging resistance, soil retention in erosion control, and subsurface drainage applications. Mirafi™ FW-Series geotextiles are used underneath rip rap or concrete revetment systems along inland waterways and coastal shorelines to protect spillways and embankment dams from overtopping flow, encapsulating cut-off drains and collection systems surrounding landfills, filtration within dams. The geotextile is used adjacent to roadways and other critical structures, encapsulating leachate collection systems under landfills while maintaining long-term clogging resistance, and encapsulating edge drains for critical structures in problematic soils.

INSTALLATION GUIDELINES*

BANK STABILIZATION / ROCK (ARMOR) UNDERLAYMENT Geotextile Placement

Place the geotextile in close contact with the soil, eliminating folds or excessive wrinkles

Mirafi™ FW-Series Woven Geotextile

both longitudinally and transversely. The geotextile need not be placed in tension before covering with riprap or other materials. Use care in placing the geotextile to avoid possible damage.

The geotextile can be joined by overlapping or sewing. Anchor the geotextile firmly at the top of the slope using an anchor trench. For maximum effectiveness, the trench should be at least 1m (3ft) from the crest of the slope and at least 0.6m (2ft) deep. Thoroughly compact soil in the trench to ensure good anchorage. When placing the geotextile along a stream or other places where water movements are expected, anchor the toe of the geotextile in a similar fashion as at the top to prevent scour beneath it.

* These guidelines serve as a general basis for installation. Detailed instructions are available from your TenCate™ representative.

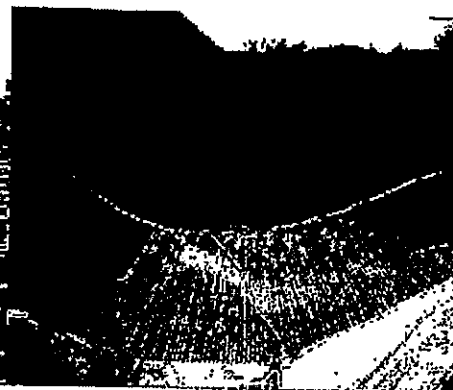
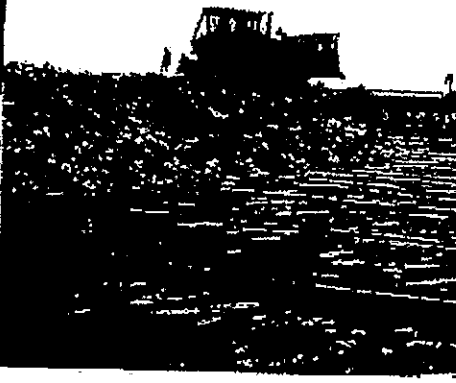

Protective & Outdoor Fabrics
Aerospace Composites
Armor Composites

Geosynthetics
Industrial Fabrics
Synthetic Grass

TENCATE Mirafi[®]

Mirafi[®] FW Woven Geotextiles for Engineered Filtration

Property / Test Method	Units	FW300	FW402	FW403	FW500	FW500	FW700
MECHANICAL PROPERTIES							
Wide Width Tensile Strength ASTM D 4595							
MD @ Ultimate	kN/m (lbs/ft)	40.3 (2760)	35.0 (2400)	47.3 (3240)	43.8 (3000)	32.1 (2196)	39.4 (2700)
CD @ Ultimate	kN/m (lbs/ft)	39.4 (2700)	24.5 (1680)	39.4 (2700)	40.3 (2760)	43.8 (3000)	25.4 (1740)
Grab Tensile Strength ASTM D 4632							
MD @ Ultimate	N (lbs)	1780 (400)	1624 (365)	1891 (425)	1780 (400)	1446 (325)	1.6 (370)
CD @ Ultimate	N (lbs)	1461 (335)	890 (200)	1558 (350)	1402 (315)	1831 (425)	1.1 (250)
MD Elongation @ Ultimate	%	15	24	21	15	15	15
CD Elongation @ Ultimate	%		10	21	15	15	15
Trapezoidal Tear Strength ASTM D 4533							
MD	N (lbs)	645 (145)	512 (115)	645 (145)	666 (150)	601 (135)	0.4 (100)
CD	N (lbs)	558 (125)	334 (75)	558 (125)	734 (165)	668 (150)	0.3 (60)
Puncture Strength ASTM D 4833							
	N (lbs)	558 (125)	401 (90)	868 (190)	668 (150)	632 (140)	0.5 (120)
UV Resistance after 500 hrs. ASTM D 4355							
	% Strength	90	90	90	90	70	90
HYDRAULIC PROPERTIES							
Apparent Opening Size (AOS) ASTM D 4751							
	mm (US Sieve)	0.08 (30)	0.43 (40)	0.43 (40)	0.43 (40)	0.30 (50)	0.212 (70)
Permittivity ASTM D 4491							
	sec ²	1.50	2.1	0.85	0.90	0.51	0.28
Percent Open Area COE-02215-86							
	%	8	10	6	1	4	4-6
Flow Rate ASTM D 4491							
	l/min/m ² (gal/min/ft ²)	4666 (115)	5907 (145)	2852 (70)	2852 (70)	1428 (35)	733.3 (18)
Packaging							
Roll Width	m (ft)	3.8 (12.5)	3.8 (12.5)	3.8 (12.5)	4.5 (15)	3.7 (12)	3.7 (12)
Roll Length	m (ft)	91 (300)	91 (300)	91 (300)	91 (300)	91 (300)	91 (300)
Est. Gross Weight	kg (lbm)	100 (221)	78.6 (169)	110 (243)	132 (292)	96 (212)	74 (164)
Area	m ² (yd ²)	348 (417)	348 (417)	348 (417)	418 (500)	334 (400)	334 (400)

*NOTE: Mechanical Properties and Hydraulic Properties shown are Minimum Average Roll Values (MARV). Apparent Opening Size (AOS) properties shown are Maximum Average Roll Values.
NP - Not Published

Mirafi[®] FW Woven Geotextiles



Shoreline Erosion Control



Leachate Collection System

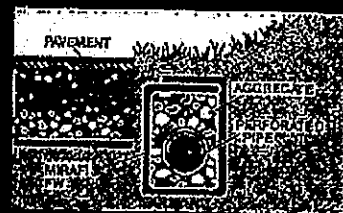

Cut-off/Interceptor Drain Along a Roadway

Mirafi[®] FW Woven Geotextiles are made from high strength, high modulus polypropylene fibers. They are available in a variety of weights and widths. Mirafi[®] FW Woven Geotextiles are designed for use in a wide range of applications, including erosion control, leachate collection, and drainage. They are available in a variety of colors and finishes. Mirafi[®] FW Woven Geotextiles are made from high strength, high modulus polypropylene fibers. They are available in a variety of weights and widths. Mirafi[®] FW Woven Geotextiles are designed for use in a wide range of applications, including erosion control, leachate collection, and drainage. They are available in a variety of colors and finishes.

POS.FW1003

365 South Holland Drive Tel 800 665 9990 Fax 705 693 4400
Pendergrass, GA 30557 Tel 708 693 2226 www.mirafi.com



TENCATE
materials that make a difference

TENCATE Mirafi



Mirafi® FW300

Mirafi® FW300 geotextile is composed of high-tenacity monofilament polypropylene yarns, which are woven into a stable network such that the yarns retain their relative position. Mirafi® FW300 geotextile is inert to biological degradation and resists naturally encountered chemicals, alkalis, and acids.

Mechanical Properties	Test Method	Unit	Minimum Average Roll Value	
			MD	CD
Wide Width Tensile Strength	ASTM D 4595	kN/m (lbs/in)	40.3 (230)	39.4 (225)
Grab Tensile Strength	ASTM D 4632	N (lbs)	1780 (400)	1491 (335)
Grab Tensile Elongation	ASTM D 4632	%	20	16
Trapezoid Tear Strength	ASTM D 4533	N (lbs)	645 (145)	556 (125)
GBR Puncture Strength	ASTM D 6241	N (lbs)	5563 (1250)	
Apparent Opening Size (AOS) ¹	ASTM D 4751	mm (U.S. Sieve)	0.60 (30)	
Percent Open Area	COE-02215	%	8	
Permittivity	ASTM D 4491	sec ⁻¹	1.5	
Permeability	ASTM D 4491	cm/sec	0.13	
Flow Rate	ASTM D 4491	l/min/m ² (gal/min/ft ²)	4685 (115)	
UV Resistance (at 500 hours)	ASTM D 4355	% strength retained	90	

¹ ASTM D 4751, AOS is a Maximum Opening Diameter Value

Physical Properties	Test Method	Unit	Typical Value
Mass/Unit Area	ASTM D 5261	g/m ² (oz/yd ²)	271 (8.0)
Thickness	ASTM D 5199	mm (mils)	0.9 (35)
Roll Dimensions (width x length)	—	m (ft)	3.8 (12.5) x 91 (300)
Roll Area	—	m ² (yd ²)	348 (417)
Estimated Roll Weight	—	kg (lbs)	100 (221)

Disclaimer: TenCate assumes no liability for the accuracy or completeness of this information or for the ultimate use by the purchaser. TenCate disclaims any and all express, implied, or statutory standards, warranties or guarantees, including without limitation any implied warranty as to merchantability or fitness for a particular purpose or arising from a course of dealing or usage of trade as to any equipment, materials, or information furnished herewith. This document should not be construed as engineering advice.



FGS000021
ETQR8

TENCATE
materials that make a difference



**INSTALLATION GUIDELINES FOR
GEOTEXTILES USED IN FILTRATION AND
DRAINAGE APPLICATIONS**

Prepared by

**TenCate Geosynthetics North America
365 South Holland Drive
Pendergrass, GA 30567
Tel: (706) 693-2226
Fax: (706) 693-2044
www.mirafi.com**

 **TENCATE**
materials that make a difference

INSTALLATION GUIDELINES FOR GEOTEXTILES USED IN FILTRATION AND DRAINAGE APPLICATIONS

GENERAL

This document is prepared to help ensure that a subsurface drainage geotextile, once installed, will perform its intended design function. To do so, the geotextile must be identified, handled, stored, and installed in such a way that its physical property values are not affected and that the design conditions are ultimately met as intended. This document contains information consistent with generally accepted methods of identifying, handling, storing and installing geotextile materials. Failure to follow these guidelines may result in the unnecessary failure of the geotextile in a properly designed application.

MATERIAL IDENTIFICATION, STORAGE AND HANDLING

The geotextile shall be rolled on cores having strength sufficient to avoid collapse or other damage from normal use. Each roll shall be wrapped with a plastic covering to protect the geotextile from damage during shipping and handling, and shall be identified with a durable gummed label or the equivalent, clearly readable on the outside of the wrapping for the roll. The label shall show the manufacturer's name, the style number, and the roll number. Roll identification corresponding to the proposed location of the roll as shown on the construction drawings and as approved by the Engineer, Owner and Contractor can be provided.

While unloading or transferring the geotextile from one location to another, prevent damage to the wrapping, core, label, or to the geotextile itself. If the geotextile is to be stored for an extended period of time, the geotextile shall be located and placed in a manner that ensures the integrity of the wrapping, core, and label as well as the physical properties of geotextile. This can be accomplished by elevating the geotextile off the ground on dunnage and ensuring that it is adequately covered and protected from ultraviolet radiation including sunlight, chemicals that are strong acids or strong bases, fire or flames including welding sparks, temperatures in excess of 60°C (140°F), and human or animal destruction.

Before unrolling the geotextile, verify the roll identification, length, and installation location with the contract drawings. While unrolling the geotextile, inspect it for damage or defects. Repair any damage that occurs during storage, handling or installation as directed by the Engineer. Normally light traffic will not damage the exposed geotextile. However, as a safety precaution, it is recommended that traffic not run on exposed geotextile.

 TENCATE
Mirafi

Mirafi® FW-Series Woven Geotextiles
High Performance Filtration Fabric



 **TENCATE**
materials that make a difference

Mirafi® FW-Series Woven Geotextiles

High Performance Filtration Fabric

The Unique Product

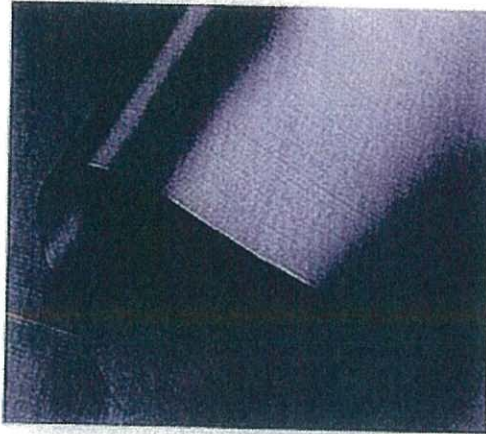

Mirafi® FW-Series geotextiles are manufactured using highly specialised fibre technology and processes to produce unique mechanical and hydraulic properties not possible with standard geotextiles, woven or nonwoven. The result is a series of geotextiles that combines the following benefits:

- High tensile strength ←
- High geotextile permeability ←
- High resistance to compression, thus permeability and pore size remain stable even when subject to high overburden loads
- Simple fabric structure that resists clogging while maintaining flow rates in high gradient and dynamic flow conditions
- Excellent durability and resistance to chemicals in aggressive environments ←
- Exceptionally high UV resistance
- Excellent survivability or damage resistance during installation

The Functions Performed

When Mirafi® FW-Series geotextiles are placed in soil, hydraulic and environmental structures they fulfill a range of functions that enhance the performance of these structures.

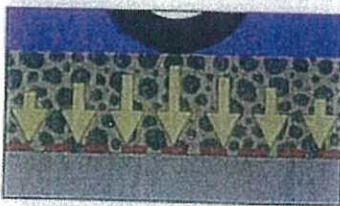

Separation: preventing the intermixing of soft foundation soils with granular materials thereby maintaining the structural integrity of the granular material.

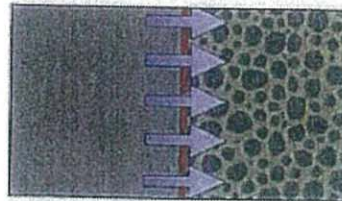

Filtration: allowing fluids to pass while preventing the migration of soil particles.

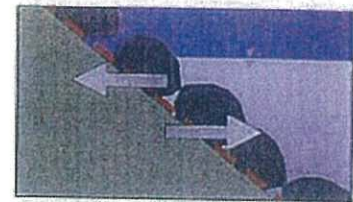

Erosion control: preventing the erosion of soil particles due to water flow, surface run-off, or wave and tidal action.

Clogging Resistance

Experience have shown that geotextile clogging may be an important design consideration under the following filtration application operating environment:

- Poorly graded fine, cohesionless, soils such as loess, rock flour, and stone quarry fines
- Cohesionless soils consisting of gap-graded, particle-size distributions and functioning under high hydraulic gradients
- Dispersive clays that separate into individual fine particles over time
- High alkalinity groundwater where the slowing of the liquid when it flows through the filter geotextile can cause a calcium, sodium, or magnesium precipitate to be deposited
- High suspended solids in the permeating liquid, as found in turbid river water or dredged water that can build up on, or within, the filter geotextile
- High suspended solids coupled with high micro-organisms content, as in landfill leachates and agricultural wastes, can combine to build up on, or within, the filter geotextile

Mirafi® FW-Series geotextiles, with a simple and open structure, offers high permeability with no complex pore space to trap particles within. They have relatively much smaller specific surface area for chemical deposits and biofilm growth. Thus Mirafi® FW-Series geotextiles have superior resistance to clogging unmatched by any conventional geotextiles in the market.

Subsurface Drainage Applications

Mirafi® FW-Series geotextiles are used as filter layer for a wide range of subsoil drainage structures; including trench drains, horizontal drainage blankets, vertical drainage behind retaining structures, chimney and toe drains to provide seepage control for earth dams and levees. Due to their high permeability even when under low hydraulic gradient conditions, they are ideally suited for sports ground drainage applications, where it is important to be able to resume play within the shortest possible time after heavy rain.

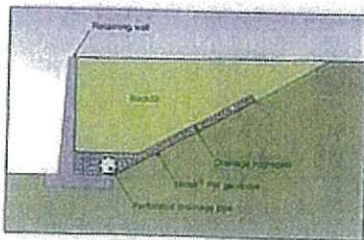

GROUND WATER SEEPAGE CONTROL

The uncontrolled movement of groundwater can be detrimental to geotechnical structures by reducing effective shear strengths in soils, lubricating failure planes, contributing to liquefaction during earthquakes and promoting soil piping. Mirafi® FW-Series geotextiles are used as filters in subsoil drainage systems for even the most problematic soils as well as groundwater seepage conditions.

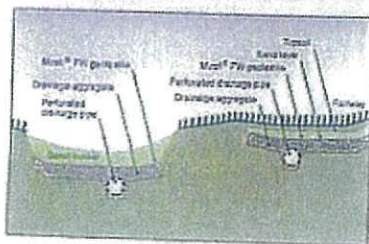

RAINWATER INFILTRATION CONTROL

Sports grounds require drainage of surface ponding of water within the shortest possible lag time after rain for early resumption of use or play. Often, that requires a drainage blanket close to the ground surface, with a highly permeable and efficient filtration system as well as minimal clogging risk over time. Mirafi® FW-Series geotextiles are ideal candidates for such applications.

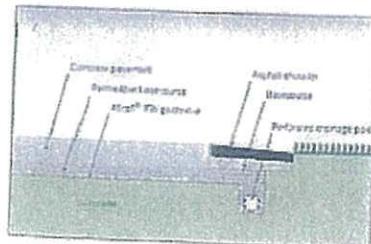

PERMEABLE PAVEMENT BASECOURSES

For pavements designed with permeable basecourses, these basecourses need to function structurally as well as hydraulically to drain away surface infiltration and groundwater seepages from the subgrade. The high strength Mirafi® FW-Series geotextiles will provide excellent ground stabilisation benefits in addition to performing the filtration function required over the lifespan of the pavement.

Marine Applications

In high gradient shoreline applications, the quick release of hydrostatic pressure through the geotextile is critical to long-term performance. Due to their low clogging potential, Mirafi® FW-Series geotextiles are also ideally suited as filter layers between soil and rock dykes as well as under armour protection layers. Mirafi® FW-Series geotextiles are extremely robust and can withstand high installation stresses. They can be easily prefabricated into large panels for quick deployment. This is done by seaming adjacent rolls of geotextiles to ensure structural continuity and integrity.

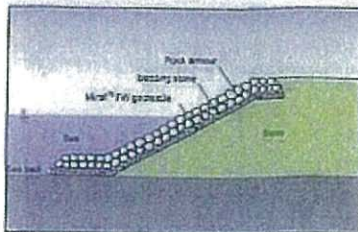
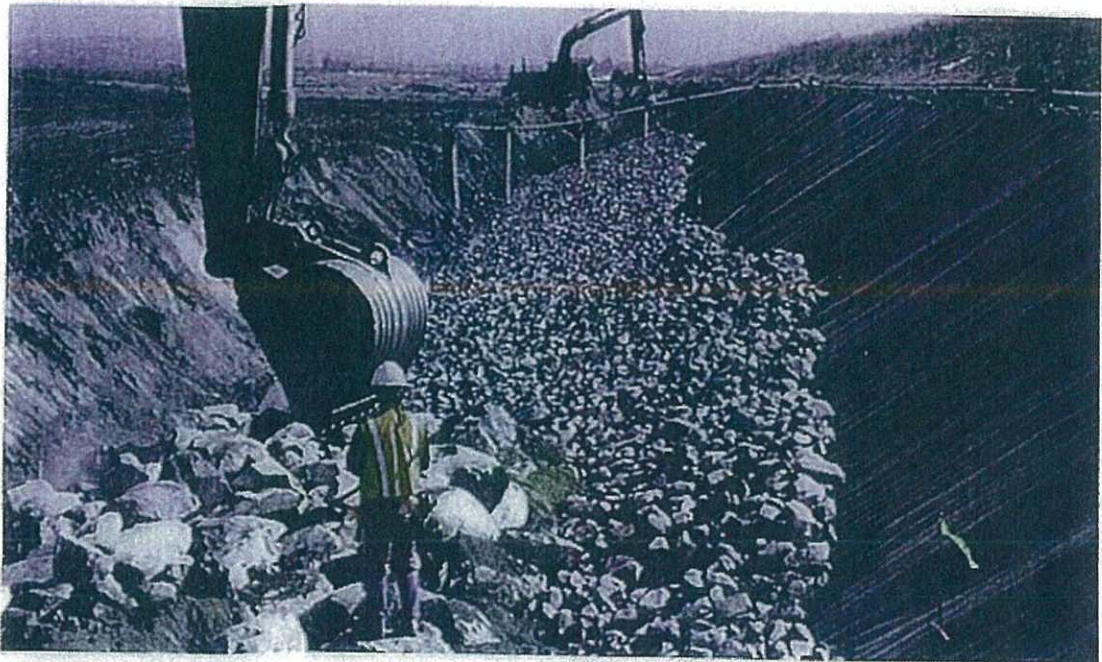

REVETMENTS

Mirafi® FW-Series geotextiles are uniquely engineered filter geotextiles that exhibit a consistent and simple pore structure along with high permeability. This makes them suitable as revetment filters for problematic soils and sands in difficult environments where quick and unimpeded release of pore water pressure is required. Mirafi® FW-Series geotextiles can be installed with ease. They have excellent resistance against ultraviolet radiation to ensure minimal loss of strength during installation exposure.

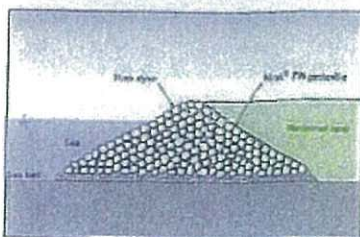

RECLAMATION DYKES

Dykes prevent soil washout by waves and currents during land reclamation works in marine environment. Mirafi® FW-Series geotextiles prevent the loss of reclamation fill through the permeable reclamation dykes, which can be an important issue especially in an environmentally sensitive area. Mirafi® FW-Series geotextiles with high permeability will ensure rapid dewatering of dredged reclamation fill.

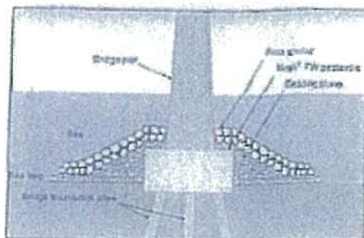

SCOUR PROTECTION LAYERS

Mirafi® FW-Series geotextiles act as filtration layer underneath scour protection armour layers. They can be prefabricated into large and unique paneling for easy underwater deployment. The high tensile strength and robust Mirafi® FW-Series geotextiles can resist high installation stresses that are normally associated with underwater installation of filtration geotextiles.

Landfill Applications

Mirafi® FW-Series geotextiles with high tensile strength are used as support layers over soft subgrades, where they act as separator and filter, before landfill liner systems are constructed. Due to their low clogging potential, they are also ideally suited as leachate filter layers prior to placement of solid wastes. Planar drainage geocomposites are often used for subsoil drainage, gas transmission and leachate detection in liner systems in landfills. Mirafi® FW geotextiles will resist caving into the drainage core space even under high compression load and are the ideal geotextiles for fabrication of the drainage composites.

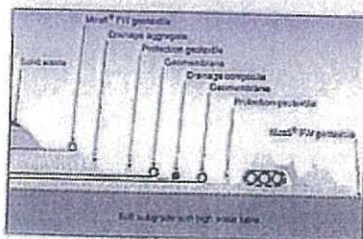

SUBGRADE STABILISATION AND DRAINAGE LAYER FILTRATION

For landfills constructed on soft ground, subgrades may need to be stabilised prior to installation of liner systems. Often, the subgrade stabilisation platform layer is required to perform a long term subsoil drainage function as well. Mirafi® FW-Series geotextiles with high tensile strength and good hydraulic properties are ideal for soft subgrade stabilisation cum drainage layer filtration in landfill engineering.

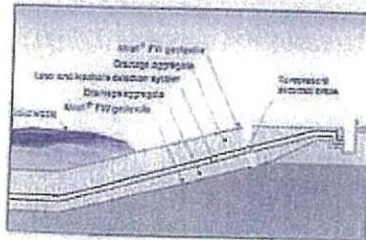

LEACHATE FILTRATION

Studies have shown that the magnitude of decrease in leachate filtration geotextile permeability in landfills depends on the openness of the geotextile, the flow rate and the concentration of the leachate. Mirafi® FW-Series geotextiles engineered with even pore sizes and a high degree of openness are the geotextiles of choice for leachate filtration in landfills.

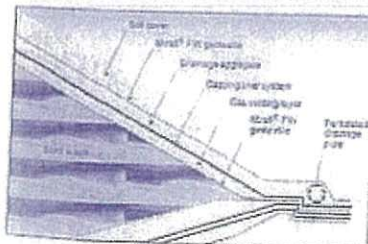

LANDFILL COVER SYSTEMS

The primary purpose of a landfill cover is to isolate waste materials from the environment by minimising the infiltration of surface water, preventing human and animal contact with waste materials, and controlling landfill gases. Mirafi® FW-Series geotextiles are ideal as filters used within cover systems for rapid removal of infiltrating water as well as generated gases from the decomposing waste matters within the landfills.

Filtration Design ⁽¹⁾

Hydraulic design criteria

There are two fundamental geotextile properties that govern how it behaves hydraulically, namely opening size (relating to the soil retention criterion) and water permeability (relating to the permeability criterion). Table 1 may be used for the hydraulic design of Mirafi® FW-Series woven geotextiles as filters and are applicable for subsurface drainage and marine applications.

	Drainage applications	Marine applications
1. Soil retention where the soil to be filtered is predominantly granular soil where the soil to be filtered is predominantly silty soil where the soil to be filtered is predominantly cohesive soil	$D_{95} \leq D_{85}$ $D_{95} \leq 2D_{50}$ $D_{95} \leq 0.22\text{mm}$	$D_{95} \leq D_{50}$ $D_{95} \leq D_{50}$ $D_{95} \leq 0.22\text{mm}$
2. Permeability	$k_t \geq A k_s$	$k_t \geq k_s$

Notes:

- (a) k_t denotes the geotextile permeability or velocity index
- (b) k_s denotes the permeability of the soil to be drained
- (c) D_{95} denotes the geotextile characteristic opening size
- (d) D_{50} denotes the soil particle size for which 50% are smaller
- (e) D_{85} denotes the soil particle size for which 85% are smaller
- (f) A denotes the safety factor applied for permeability (for normal applications, A = 1; for high clogging risk applications, A = 10)

Mechanical design criteria

In addition the filter geotextile must also survive the installation process (relating to the mechanical criteria). If the geotextile does not have adequate mechanical properties, it may become punctured or torn during installation resulting in adverse effects on its hydraulic performance. The mechanical property requirements of the geotextile filter are related to the types and magnitudes of the stresses imparted by the permeable drainage media in contact with the geotextile filter. Most applications involve the filter geotextile to be in contact with stones. The installation for subsurface drainage applications typically involves either stones dropped directly onto the geotextile (eg. trench drains) or stones tipped onto a stabilised aggregate platform that is extended further by dozing the stones over the edge of the platform (eg. subsurface blanket drains). The installation for erosion control systems typically involves either stones dropped directly onto the geotextile (eg. revetments and scour protection layers) or the geotextile is placed after the stones have been installed (eg. reclamation dykes). When stones are dropped directly onto the geotextile, the mechanical strength requirement would depend on the size of stone and the height that it is dropped from. When stones are dozed from the edge of an aggregate platform, the mechanical strength requirement would depend on the size of stone and the subgrade CBR strength beneath the aggregate platform.

Operating spectra of Mirafi® FW-Series geotextiles as filters for subsurface drainage applications

For a specific geotextile of known mechanical properties, it would be possible to develop an operating spectrum for subsurface drainage applications with a specific mode of installation of geotextile. Figure 1 shows the operating spectra of Mirafi® FW-Series geotextiles for use as filter layer at the underside of blanket drains. Figure 2 shows the operating spectra of Mirafi® FW-Series geotextiles for use as filter layer in trench drains.

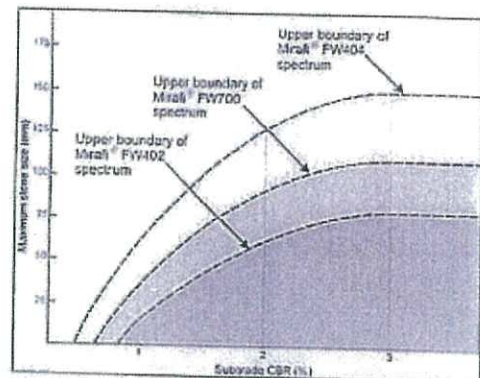

Figure 1: Operating spectra of Mirafi® FW-Series geotextiles for use at the underside of blanket drains

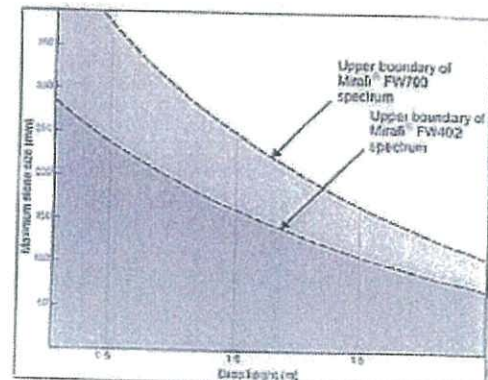

Figure 2: Operating spectra of Mirafi® FW-Series geotextiles for use in trench drains

Filtration Design ⁽²⁾

Operating spectra of Mirafi® FW-Series geotextiles as filters for marine applications

For a specific geotextile of known mechanical properties, it would be possible to develop an operating spectrum for marine applications with a specific mode of installation of geotextile. Figure 3 shows the operating spectra of Mirafi® FW-Series geotextiles for use as filter layer in revetments and scour protection applications. Figure 4 shows the operating spectra of Mirafi® FW-Series geotextiles for use as filter layer between reclamation dykes and fill.

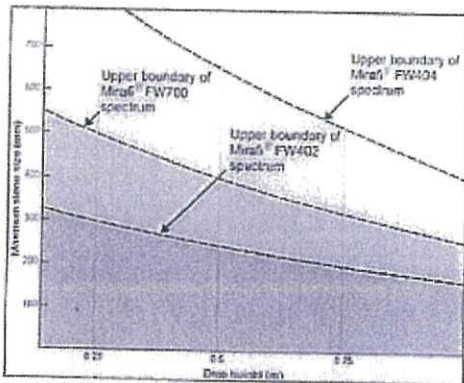

Figure 3: Operating spectra of Mirafi® FW-Series geotextiles for use in revetments and scour protection

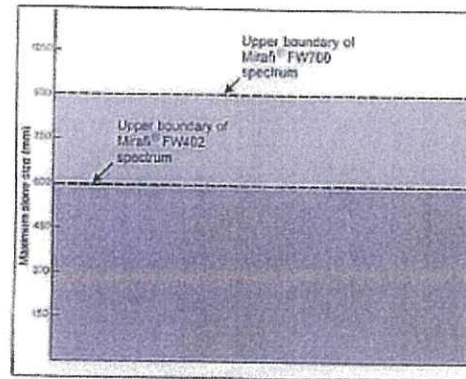

Figure 4: Operating spectra of Mirafi® FW-Series geotextiles for use between reclamation dykes and fill

Leachate filtration in landfills

The role of geotextile filter in leachate drainage and collection system is to allow adequate leachate flow from the solid waste through to the drainage blanket and at the same time prevent or reduce clogging in the drainage gravel and pipes. The use of geotextile as a filter above the drainage gravel has been reported to result in less clogging than that observed in areas with no geotextile filter (Rowe et al., 2004).

Chemical and microbiological clogging is a critical issue for leachate filter geotextiles in landfills. The rate of reduction of geotextile permeability due to chemical and microbiological clogging is dependent on the initial pore size and the solid surface area that the leachate will come into contact with while flowing through the geotextile. Woven monofilament geotextiles (eg. Mirafi® FW-Series geotextiles) are the preferred engineering choice for leachate filtration. Giroud (1996) has discussed the issue of clogging as part of a broad review of filter design. He tentatively recommends that sand and nonwoven filters should not be used even if the waste has been stabilised to produce low strength leachate by pretreatment. Rather, he recommends the use of monofilament woven geotextiles. Percent opening area (POA) should be an additional specification item for leachate filter geotextiles. Koerner and Koerner (1995) recommended that for mild leachate, monofilament woven geotextiles should have a minimum POA of 10%. For more severe leachate conditions, the minimum POA of 15% should be specified as per the recommendation of Giroud (1996).

Leachate filter geotextiles are sometimes left uncovered for significant periods of time. UV resistance of geotextile is an important consideration and should also be a specification item for leachate filter geotextiles. It is recommended that a strength retention of 90% according to the UV resistance test ASTM D4355 be specified.

Filtration is a critical element in design and geotextile filters must not be selected on cost alone. Often, the cost of geotextile filters is an insignificant contribution to the overall project cost but the consequence of problems associated with use of an inadequate geotextile filter can be very significant.

References

- Giroud, J.P. (1996). *Granular Filters and Geotextile Filters*, Proceedings Geofilters '96, pp. 565-580.
- Koerner, R.M. & Koerner, G.R. (1995). *Leachate clogging assessment of geotextile (and soil) landfill for filters*, US EPA Report, CR-619371, Merck.
- Rowe, R.K., Quigley, R.M. & Booker, J.R. (2004). *Barrier Systems for Waste Disposal Facilities*, 2nd Edition, Spon Press: London & New York, 978 pgs.

TenCate develops and produces materials that function to increase performance, reduce cost and deliver measurable results by working with our customers to provide advanced solutions.

TenCate Zhuhai Industrial Co., Ltd.
South of Nangang West Road,
Gaolan Port Economic Zone,
Zhuhai 519030, Guangdong, China
Tel +86 756 886 1616
Fax 86 756 886 1610
Email info.zhuhai@tencate.com

TenCate Geosynthetics Asia Sdn. Bhd.
14, Jalan Sementa 27/81, Seksyen 27,
40100 Shah Alam, Selangor Darul Ehsan,
Malaysia
Tel +60 3 5192 8558
Fax +60 3 5192 8575
Email info.asia@tencate.com

Royal TenCate Pacific Ltd.
Suite 3205, The Center,
89 Queen's Road Central,
Hong Kong
Tel +852 2295 0618
Fax +852 2169 0276
Email info.hongkong@tencate.com

 **TENCATE**
materials that make a difference

TenCate is a registered trademark of Royal TenCate. The information contained herein is the best of our knowledge and belief. It is provided for informational purposes only and does not constitute an offer of insurance or any other financial product. Please contact your broker for more information. Royal TenCate is not responsible for any errors or omissions in this information. Royal TenCate is not a financial institution and does not provide financial advice. Royal TenCate is not a financial institution and does not provide financial advice.



俊和 - 中國中鐵聯營

CHUN WO - CRGL JOINT VENTURE

Contract No. HK/2009/02

Wan Chai Development Phase II

Central - Wan Chai Bypass at Wan Chai East

Silt Screen Deployment Plan

Appendix F

Technical Properties of the Steel Mesh Material – Golik 228G



GALVANIZED / STAINLESS STEEL MESH 鍍鋅 / 不銹鋼網

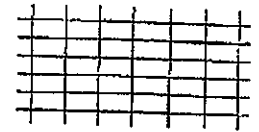

Golik Reference No. 高力編號		Diameter 鍍鋅網規格		Pitch 網眼規格		Sheet Size 網片規格		Weight 重量
Galvanized Steel 鍍鋅	Stainless Steel 不銹鋼	Main 直 (mm)	Cross 橫 (mm)	Main 直 (A) (mm)	Cross 橫 (B) (mm)	Width 闊 (W) (Metre)	Length 長 (L) (Metre)	
21G	21S	4.00	3.00	50	25	2.1	3.6	4.18
210G	210S	3.00	3.00	50	50	2.1	3.6	2.20
228G	228S	4.00	4.00	50	50	2.1	3.6	3.96
31G	31S	4.00	3.00	75	25	2.1	3.6	3.52
310G	310S	3.00	3.00	75	75	2.1	3.6	1.46
3110G	3110S	3.00	3.00	75	25	2.1	3.6	2.93
310aG	-	3.20	3.20	75	75	2.1	3.6	1.68
410G	410S	3.00	3.00	100	100	2.1	3.6	1.11
48G	48S	4.00	4.00	100	100	2.1	3.6	1.98
1111G	1111S	3.00	3.00	25	25	2.1	3.6	4.40
1112G	1112S	2.70	2.70	25	25	1.2	2.1	3.64
3315 *	- *	1.50	1.50	75	75	1.8	30.0	0.36
D31 *	D31S *	2.00	2.00	100	100	1.8	60.0	0.50
E31 *	E31S *	2.00	2.00	50	50	1.8	30.0	0.99
D49 *	D49S *	2.50	2.50	100	100	1.8	50.0	0.77
E49 *	E49S *	2.50	2.50	50	50	1.8	20.0	1.54
E49a (2212) *	E49aS *	2.70	2.70	50	50	1.8	20.0	1.40
1520G *	1520S *	1.50	1.50	20	20	0.915	30.0	1.12
1117G *	1117S *	1.50	1.50	25	25	0.915	30.0	0.72
1118G *	1118S *	1.20	1.20	25	25	0.915	30.0	0.48
1119G *	1119S *	1.00	1.00	25	25	0.915	30.0	

Remark: (1) "*" Types of mesh are supplied in form of rolls.

(2) Stainless Steel Mesh is supplied in grade of AISI 304 and AISI 316.

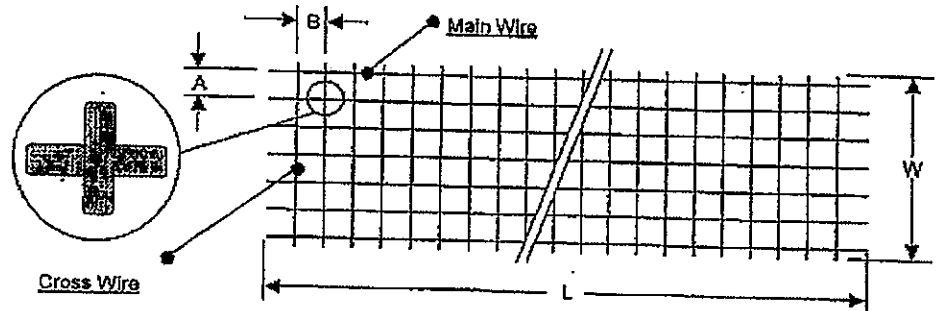

Galvanized Mesh used in Fencing
使用於圍欄之鍍鋅網



Galvanized Mesh in rolls
卷裝鍍鋅網

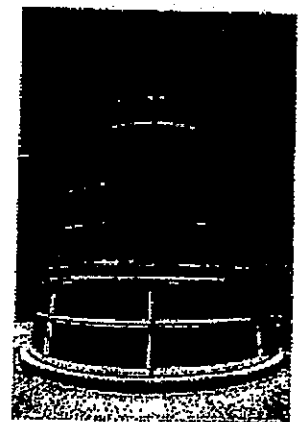

Other usage of Galvanized Mesh
鍍鋅網之其它使用方法

CONTENTS

目錄

INTRODUCTION 公司簡介	1
OUR PRODUCTS 產品介紹	2
APPLICATIONS 用途	3-5
SPECIFICATIONS 標準	6-7
STANDARD SIZES OF GOLIK FABRIC 標準規格	8
HOW TO ORDER NON-STANDARD FABRIC 怎樣訂製非標準鋼筋網	9
STRUCTURAL DRAWING 設計圖則	10-11
TECHNICAL DETAILS FOR FABRIC 鋼筋網技術細節	12-14
GALVANIZED / STAINLESS STEEL MESH 鍍鋅 / 不銹鋼網	15
OTHER PRODUCTS 其它產品	16
APPLICATIONS OF FABRIC 鋼筋網應用	17
PROJECT REFERENCES 參予工程	18-19
QUALITY ASSURANCE 質量保證	20



INTRODUCTION 公司簡介

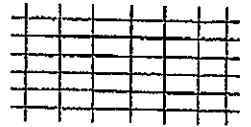

Golik Metal Manufacturing Co., Ltd. was established in 1977 and rapidly emerged as one of Hong Kong's leading manufacturers and suppliers of Welded Steel Wire Fabric and steel mesh related products used in the building and civil construction works.

Our experience has been acquired over 25 years of manufacturing Welded Steel Wire Fabric. During the Period, we have produced over 250,000 tons of Fabric and related products destined for most projects in Hong Kong, Macau and China.

Golik had successfully acquired the qualification of ISO 9002 Certification in 1995 and ISO 9001: 2000 in 2003. In addition, Golik had been approved as Quality Assured Stockist In 1998, for reinforcing steel bars.

This brochure is intended to provide product information, material specifications and some technical details of Welded Steel Wire Fabric for Architects, Designers, Engineers, and Contractors.

高力金屬製品廠有限公司創立於1977年。現已發展成為香港主要的熔接鋼筋網生產商及其它有關之鋼網產品供應商。

我們已有超過 25 年生產及供應熔接鋼筋網的經驗。其間已生產超過 250,000 噸各種熔接鋼筋網供應香港、澳門及中國地區的各项大小房屋及基建工程。

高力於一九九五年成功獲取 ISO 9002 之國際認證，並於二零零三年提升為 ISO 9001: 2000 年版本之審核認證；在一九九八年則通過 Quality Assured Stockist 認證，成為認可之熱軋鋼筋供應商。

這產品目錄主要是提供所生產鋼筋網之標準及規格，以及一些使用的技術資料，以加深各有關之技術人員（則師、設計人員、工程師）及承建商對熔接鋼筋網之了解。





OUR PRODUCTS 產品介紹

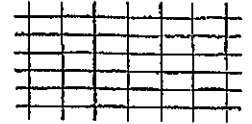

BENEFITS OF USING GOLIK FABRIC

高力鋼筋網的優點

In an environment of increased site-labour cost, Golik Fabric provides Developers, Designers, Engineers and Contractors a convenient and economical steel reinforcement for concrete structures. Golik produces wide range of mesh products include Standard Fabric, Non-standard Fabric and tailor-made Engineered Fabric. Other products such as galvanized finemesh, galvanized wire mesh and hard-drawn wires etc.

在目前建築業勞工成本上升情況下，高力鋼筋網給發展商、設計師、工程師及建築商提供了一種使用於混凝土結構上之經濟、方便及高效的建築材料。我們的產品包括標準、非標準及特定規格鋼筋網，其他產品包括有鍍鋅電焊網及冷拉鋼筋等。



GOLIK FABRIC FOR CONCRETE REINFORCEMENT

高力鋼筋網用於混凝土結構

Golik Fabric is a prefabricated steel product which replaces traditional steel cutting and fixing. The higher strength of the Golik Fabric can considerably save the quantity of steel used on a project.

高力鋼筋網主要是用以代替傳統人手裁剪及固定鋼筋的建築方法。使用高強度性能的高力鋼筋網代替傳統方法可以節省鋼材。





APPLICATIONS 用途

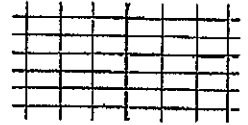

GOLIK FABRIC IS QUALITY STEEL FIXING 高力鋼筋網能保證工程質量

The spacing of the steel wires is uniformly controlled, as Golik Fabric is produced by fully computerized mesh making machines. Each wire intersection is welded with a controlled weld, not loosely fixed with tying wire. Golik Fabric eliminates human error in manual steel fixing. Golik Fabric is widely used for the following applications: **Paving, Buildings, Concrete Pipes, Shaped Fabric, Precast Components etc.**

高力鋼筋網的鋼筋排法是標準化及機械化。使用標準化的鋼筋網可以大大減少由人手綁扎而做成的錯漏。高力鋼筋網片已廣泛地被使用於：路面地台、高層建築物、水泥管、混凝土預製件等。



PAVING 路面及地台

Concrete pavements are exposed directly to atmospheric conditions, expanding and contracting with every change of temperature or moisture condition. Golik Fabric functions as shrinkage reinforcement, permitting the transfer of internal stresses and loads, maintaining an even surface, and safeguarding the strength and durability of the pavement.

一般混凝土路面龜裂的主要原因是受到溫度及濕度變化而膨脹或收縮。高力鋼筋能有效地加強路面之強度及平均分散路面所承受之壓力，有效地減少混凝土路面出現龜裂之情況。





APPLICATIONS 用途

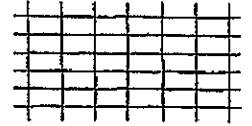

BUILDINGS

高層建築物

Golik Fabric is used successfully and economically in practically every form of concrete building such as footings, slabs, walls, staircases, refuse chutes. Golik Fabric is adaptable for use for all types of building designs, including public housing, office buildings, schools, hospitals, industrial and commercial buildings, airport hardstanding's, apartments and other residential buildings.

高力鋼筋網在高層建築工程中代替普通鋼筋都有非常成功及滿意的效果。工程包括有公共房屋、政府辦公大樓、學校、醫院、工業及商業大廈等。從數據顯示，使用高力鋼筋網能夠節省大量人手及施工時間。



CONCRETE PIPES

預製水泥管

Golik Fabric and Golik Hard Drawn Wire are standard reinforcing materials used in the manufacture of concrete pipes. Welded steel fabric is used because of its high strength and consequently, less material is required. If mild steel bars are used in the same application, about 40% more steel is required.

高力鋼筋網及冷拉鋼筋用於生產預製大型水泥管是一種堅固及標準化之材料。由於溶接鋼筋網的抗拉强度高，在製造同一產品時，比使用普通鋼筋節省高達40%之材料。





APPLICATIONS 用途

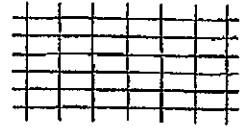

SHAPED FABRIC

成型鋼筋網

Golik Fabric can easily be bent to required shapes, U-shape or L-shape or trapezoidal to reinforce concrete walls, panels, floor slabs or drains. Use of shaped fabric ensures better quality workmanship, lower steel wastage and higher productivity.

高力鋼筋網可以加工屈成各種形狀如 U 型、L 型或其他特別形狀；以配合設計不同之結構混凝土牆、預製牆、樓面及水渠等。使用已加工成形之鋼筋網可以保證工程質量，減低鋼材損耗及能提高效率。

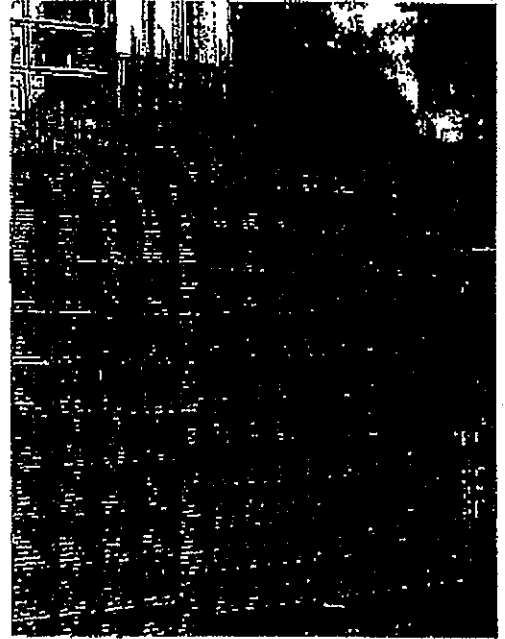

PRECAST COMPONENTS

預製混凝土產品

The quality of construction work has improved significantly with the use of precast components. Golik Fabric is widely used in precast components ranging from architectural precast facades, parapet walls, lightweight partition panels, sun shades, staircases, refuse chutes, planks (slabs), water tanks, secondary roofing, U-drains and box culverts etc.

在建築工程中使用預製混凝土件可以把工程質量大大提高。高力熔接鋼筋網是預製混凝土產品最好的結構材料；已被廣泛地使用於大部份鋼筋混凝土件如樓宇外牆、間隔牆、簷蓬、樓梯及樓面板等。

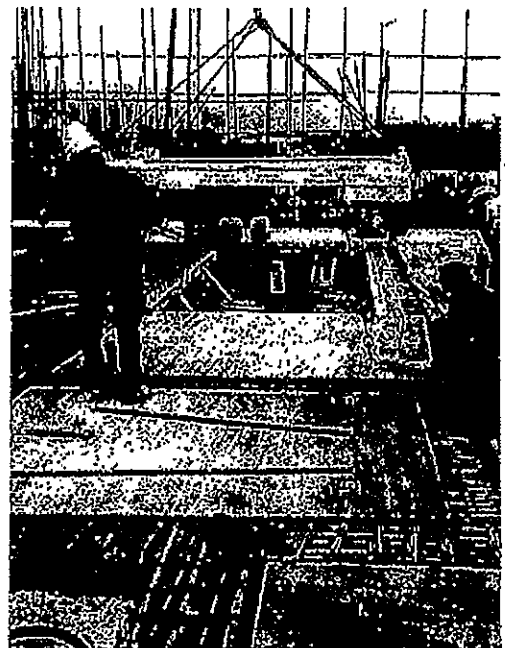



SPECIFICATIONS 標準

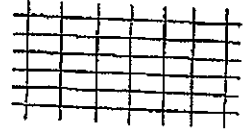

CONFORMITY TO INTERNATIONAL STANDARDS

符合國際標準

Golik Fabric is manufactured in accordance with the following standards:

- BS4482 "Cold Reduced Steel Wire for the Reinforcement of Concrete"
- BS4483 "Steel Fabric for the Reinforcement of Concrete"
- BS4466 "Scheduling, dimensioning, bending and cutting of steel reinforcement for concrete"
- ASTM A82 "Steel Wire, Plain, for Concrete Reinforcement"
- ASTM A185 "Steel Welded Wire Fabric, Plain, for Concrete Reinforcement"

高力鋼筋網是按照以下標準生產：

- 英國標準 BS4482:1985
- 英國標準 BS4483:1985
- 英國標準 BS4466:1989
- 美國標準 ASTM A82
- 美國標準 ASTM A185

TENSILE PROPERTIES

拉伸特性

The British Standards BS4482:1985 & BS4483:1985, requires that the cold-drawn steel wire used in the Welded Steel Fabric must have a minimum proof stress of 460N/mm^2 .

英國標準 BS4482:1985 及 BS4483:1985 要求用作生產熔焊鋼筋網的“冷拉鋼筋”之屈服強度不少於 460N/mm^2 。

WELD SHEAR

熔接點強度

Golik Fabric is welded into secure mats of reinforcement. The shearing load required to produce failure of a welded intersection is not less than $0.25 A_f y$ where A is the nominal cross-sectional area of the smaller wire and $f_y = 460\text{N/mm}^2$.

高力鋼筋網是利用電焊方法將縱橫鋼筋熔接。熔接點的剪斷強度要求不低於 $0.25 A_f y$ ，A 是較小的鋼筋之橫切面積， f_y 是等於 460N/mm^2 。

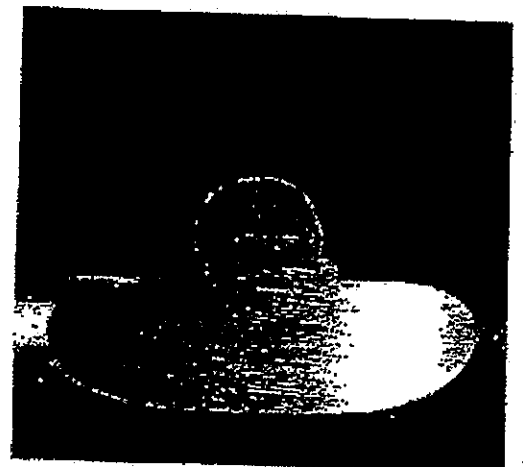
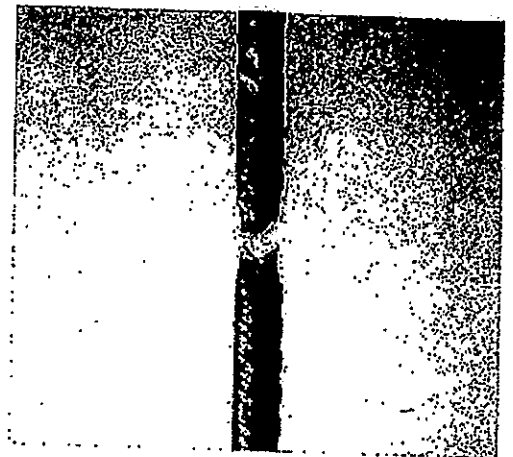
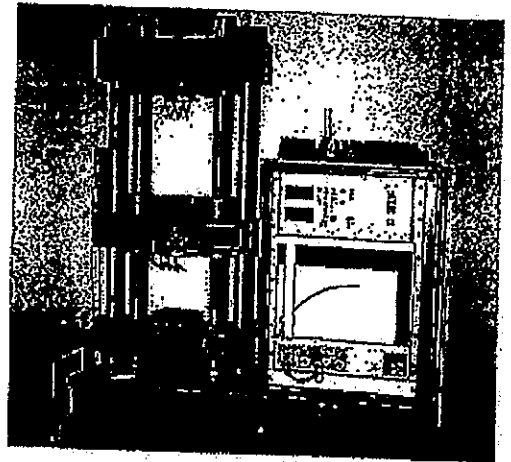



SPECIFICATIONS 標準

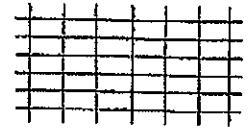

GOLIK FABRIC

高力鋼筋網

Golik Fabric is prefabricated steel reinforcement consisting of a series of parallel, longitudinal, cold-drawn high-yield steel wires welded at regular intervals to transverse wires. Golik Fabric is manufactured on automatic welding machines, ensuring uniform spacing of wires providing consistent cross sectional areas of steel.

高力鋼筋網是使用經過冷拉處理而成之高抗拉力鋼筋，進行有規則之縱橫方向排列後焊接而製成的。

高力鋼筋網是使用大型自動焊接機，按照標準大批量焊製成鋼筋網片；使用電腦控制之焊接機能保證生產出貨量及規格統一之鋼筋網片。

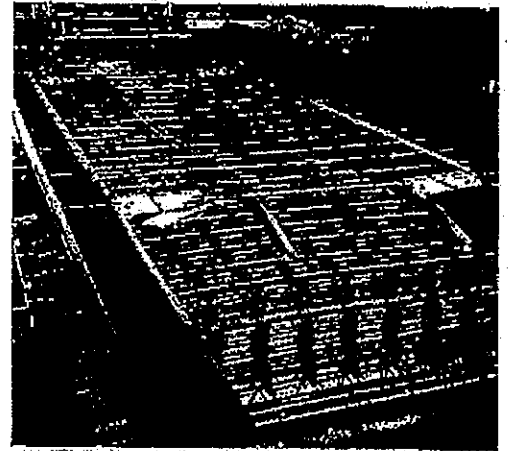

PLAIN ROUND STEEL FABRIC

光面鋼筋網

Plain round Steel Fabric has been used as prefabricated reinforcement for reinforced concrete construction around the world for more than sixty years.

光面鋼筋網片使用於鋼筋混凝土在世界各地建築工程方面已有超過60年歷史。

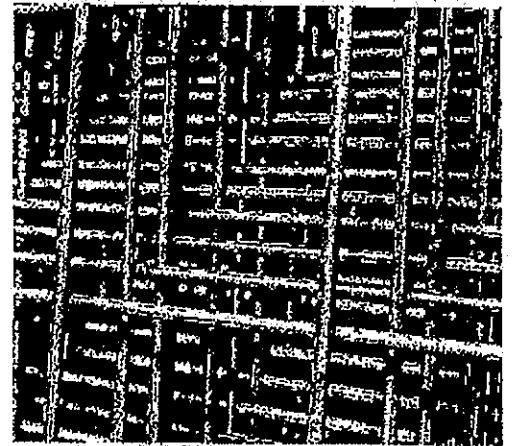

DEFORMED STEEL WIRE

帶肋鋼筋

Deformed Steel Wire is used as reinforcement for various concrete elements and structures either as wire, cut into lengths, or bent into the required shape to fix into the concrete. Deformed Wire complies to all the requirements BS4482, BS4466 and BS4449 weldable quality steel reinforcement. The deformations improve the "local bond" of the steel bars in the concrete.

帶肋鋼筋已廣泛地用於鋼筋混凝土方面，可以剪切成長短及屈成不同形狀。帶肋鋼筋符合BS4482, BS4466及BS4449標準，帶肋鋼筋可以增強鋼筋在混凝土中的"附著力"。

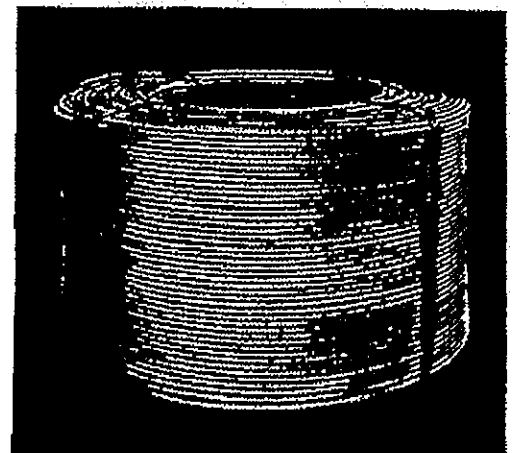



APPLICATIONS OF FABRIC 鋼筋網應用

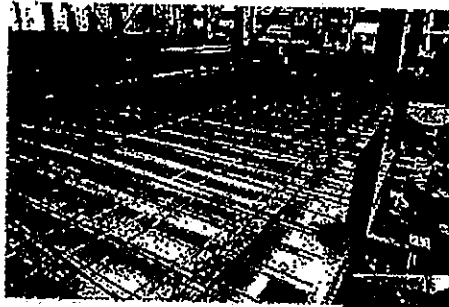

Floor Making of Buildings
多層大廈之樓面鋪設

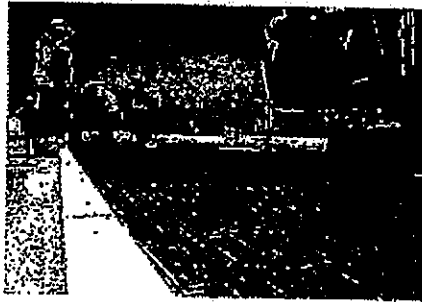

Paving of Motor way
鋪設行車公路

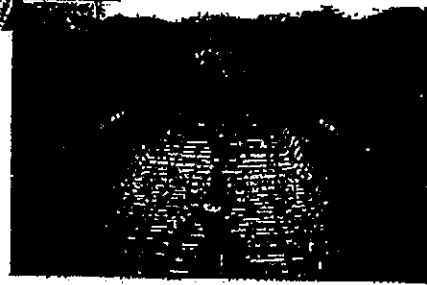

Channel of Drainage
河道橋梁

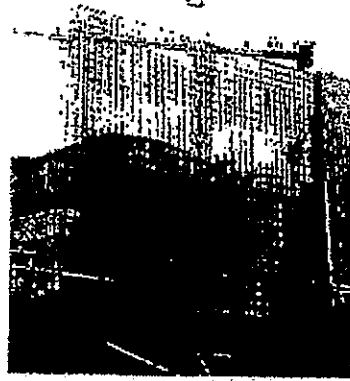

Protecting Wall Constructing
保護牆之建造

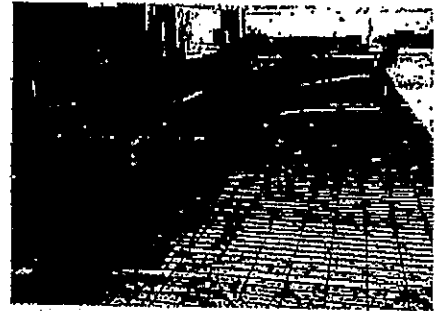

Concrete Pavement
澆築土地台



Semi-Precast Slabs
預製樓面板

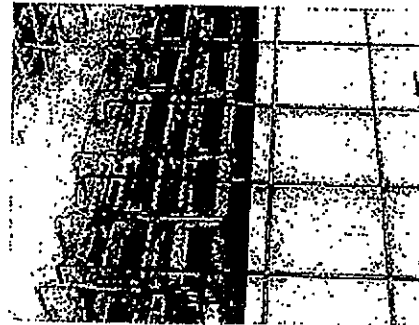

Wall and Slab Intersector
牆身與樓面接合



PROJECT REFERENCES 參予工程

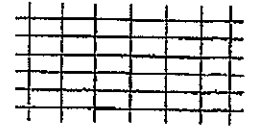

Hong Kong International Airport
香港國際機場



Central Plaza
中環廣場



Western Cross Harbour Tunnel
西隧



Hong Kong Convention & Exhibition Centre
香港會議展覽中心

Times Square
時代廣場



Tsing Ma Bridge
青馬大橋



The Hong Kong and Shanghai Banking Corporation Headquarter
香港滙豐銀行總行



PROJECT REFERENCES 參予工程

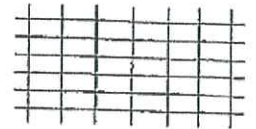

Tai Po Water Treatment and Pumping Work
大埔抽水站工程

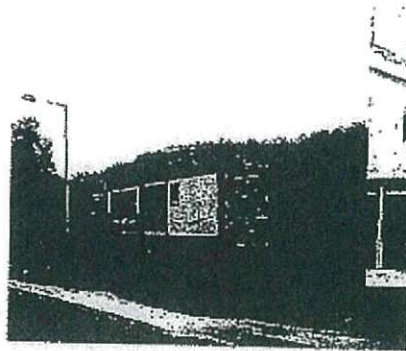

MTR Tseung Kwan O Station
地鐵將軍澳站

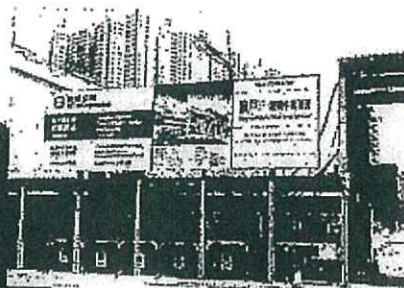

Tseung Kwan O MTR Depot
將軍澳地鐵車廠

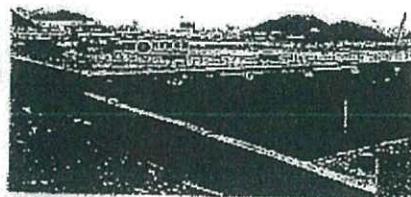

Yau Tong No.2 Reservoir
油塘二號水庫

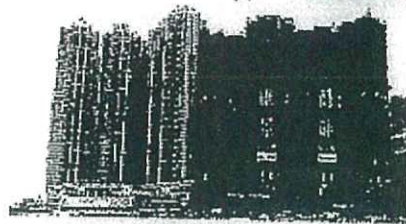
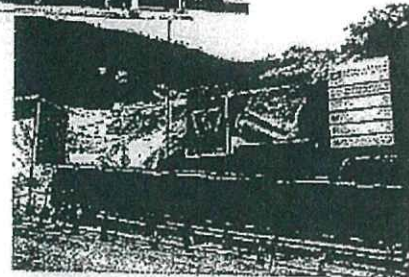

Ocean Shore Phase I & II
維景灣畔第一及二期

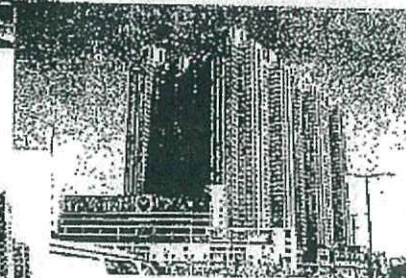

Tseung Kwan O Bauhinia Garden
將軍澳寶盈花園



Tseung Kwan O Choi Ming Court
將軍澳彩明苑



North District Hospital
北區醫院

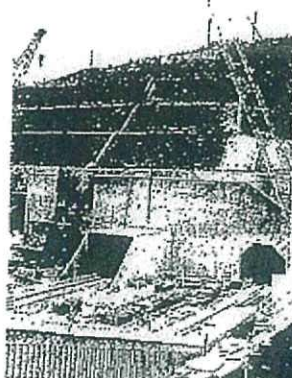

Tseung Kwan O Pak Shing Kwok Tunnels
將軍澳白樹角隧道

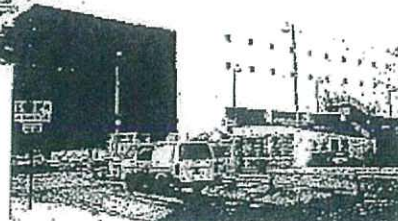

Sheung Shui Slaughterhouse
上水屠房



Yau Tong Phase 5
油塘5期



俊和 - 中國中鐵聯營

CHUN WO - CRGL JOINT VENTURE

Contract No. HK/2009/02

Wan Chai Development Phase II

Central - Wan Chai Bypass at Wan Chai East

Silt Screen Deployment Plan

Appendix G

Access of Environmental Team to carry out water measurement and sampling

Temporary access plan to/from new pumping stations (P7, P8 & P9)

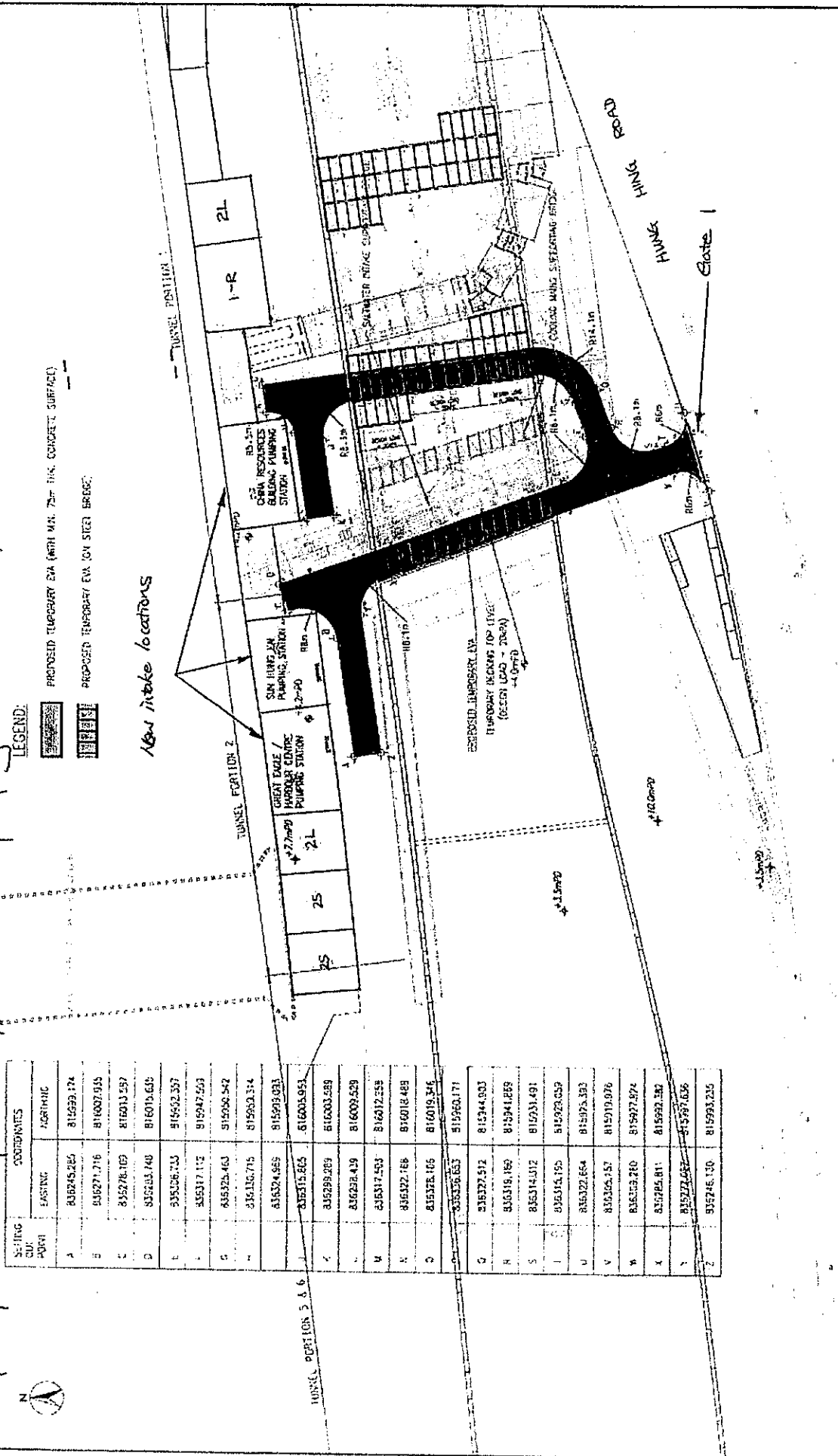



俊和 - 中國中鐵聯營

CHUN WO - CRGL JOINT VENTURE

Contract No. HK/2009/02

Wan Chai Development Phase II

Central - Wan Chai Bypass at Wan Chai East

Silt Screen Deployment Plan

Appendix H

Layout of Silt Curtain Screen to be provided to the intakes for phase 3 works.

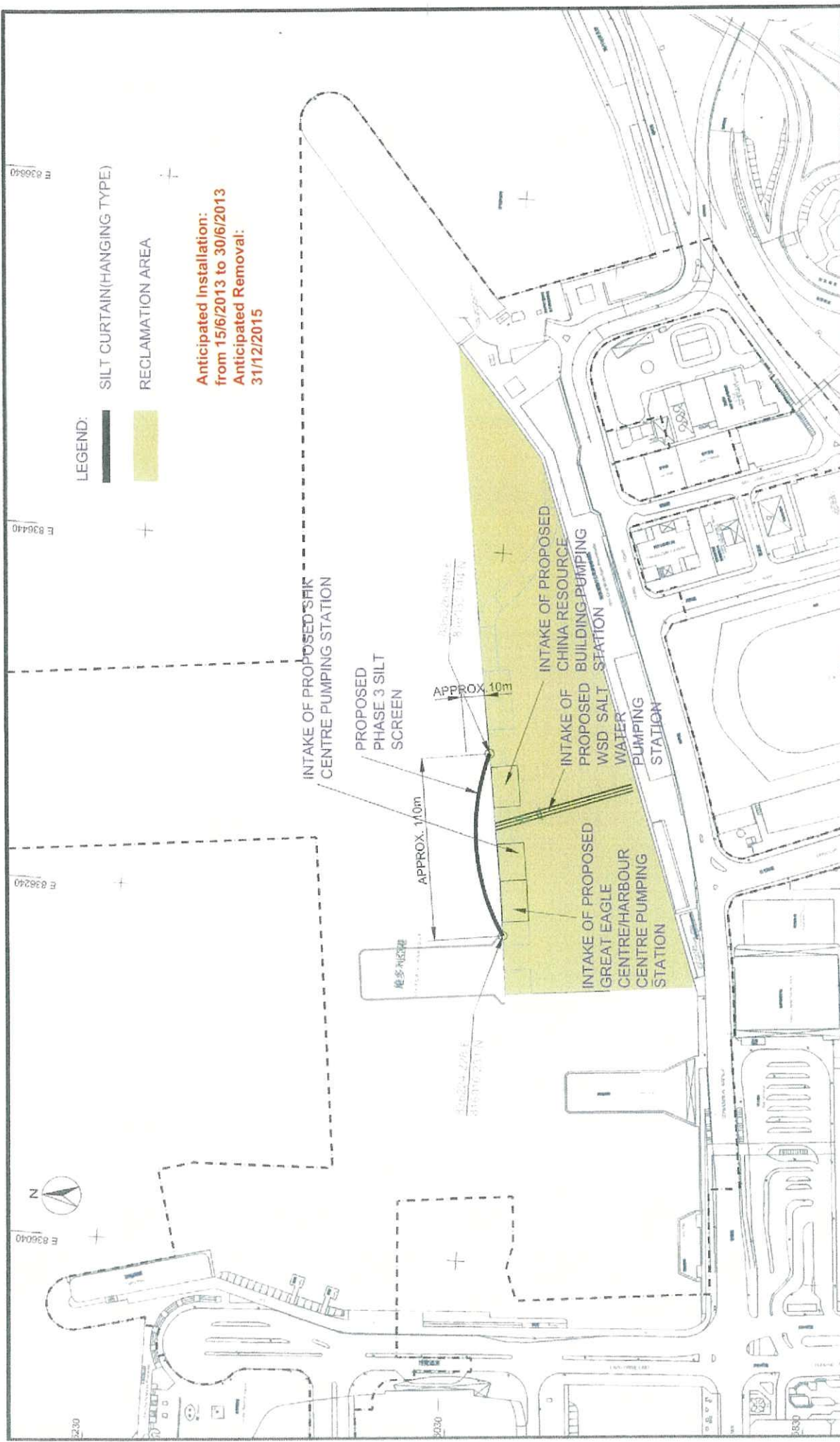

Anticipated Installation:
from 15/6/2013 to 30/6/2013
Anticipated Removal:
31/12/2015

CONTRACTOR 		CONTRACT NO. HK200902 WAN CHAI DEVELOPMENT PHASE II CENTRAL - WAN CHAI BYPASS AT WAN CHAI EAST		REV A 14 JAN 2013 GENERAL REVISION		DATE 14 JAN 2013		DESCRIPTION GENERAL REVISION	
ORG. TITLE: LAYOUT OF SILT CURTAIN SCREEN FOR GREAT EAGLE/HARBOUR PUMPING, CHINA RESOURCE BUILDING, WSD SALT WATER AND SHK CENTRE PUMPING STATION									
SCALE 1:2000		CAD REF CW-CR/ENG/ENG-2156		SCALE 1:2000		DATE 06 NOV 2012		REV A	
DRAWN YS MAK		DESIGNED YS MAK		DRAWN YS MAK		DESIGNED YS MAK		CHKD BY CECIL CHENG	
CHECKED CECIL CHENG		APPROVED CECIL CHENG		CHKD BY CECIL CHENG		DESIGNED YS MAK		APPROVED CECIL CHENG	
PROJECT WAN CHAI DEVELOPMENT PHASE II CENTRAL - WAN CHAI BYPASS AT WAN CHAI EAST		CONTRACT NO. HK200902		CONTRACTOR 俊和 - 中國中鐵聯營 CH2N WQ - CRGL JOINT VENTURE		DATE 14 JAN 2013		DESCRIPTION GENERAL REVISION	



俊和 - 中國中鐵聯營

CHUN WO - CRGL JOINT VENTURE

Contract No. HK/2009/02

Wan Chai Development Phase II

Central - Wan Chai Bypass at Wan Chai East

Silt Screen Deployment Plan

Appendix I

Technical details of Silt Curtain Screen for phase 3 works



Material Submission

**Woven Geotextile
Kimdatex CEF2101**

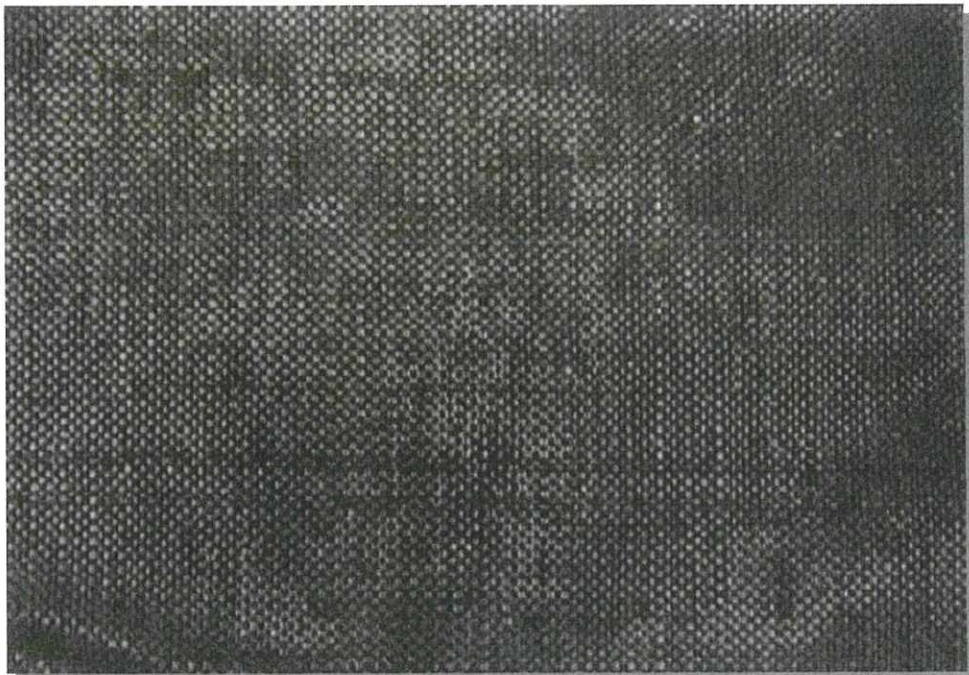

G AND E COMPANY LIMITED

14th Floor, Kiu Yin Commercial Building

361-363 Lockhart Road, Wanchai, HK

Tel: 2570 0103 Fax: 2570 0089 website: www.g-and-e.com

June 2012



Table of Contents

- 1) **Manufacturer Company Profile**

 - Yizheng Kimda Industrial Fabrics

- 2) **Product Specification**

 - Kimdatex CEF 2101 technical data sheet

- 3) **Certification**

 - ISO 9001:2008 for Quality Management System

- 4) **Installation Guideline**

 - Recommendation on Installation

- 5) **List of Project Reference**

 - Name & details of projects

- 6) **Approval Letters**

 - Yizheng Kimda's product recognition

- 7) **Photo References**

 - Project application

- 8) **About the Supplier – G and E Company Limited**

 - Introduction to G and E Company Limited



Woven Geotextile
Kimdatex CEF2101

Manufacturing Company Profile

KIMDA



WHO WE ARE

Yizheng Kimda Industrial Fabrics is a keen company in the industry, with investment of 80million RMB. The company has a large production capacity (up to 60million sqm), covering a wide range of products. We have the most advanced extrusion and lot beaming system in China, and imported, from Europe, the most advanced fibrillation and weaving equipment. Core machineries are supplied from Germany, Italy and Switzerland. We also have a complete set of accurate and reliable testing machine and equipment, which allows us to do comprehensive testing. The testing methods that we used are in accordance with the internationally recognized ISO certification.

Our company is set up to meet the demands of today's often changing requirements by introducing and utilizing the most sophisticated and efficient production facilities in the industry. We employ and train the most professional work force in the industry. The management was the group of production and

technical personnel in the early dates of Sino-US joint venture Yizheng-AMOCO (PROPEX) Fabric Company, pioneer of geotextile in China. They are experienced and highly skilled in the manufacturing of geotextile. With over 15 years of operation experience, they devoted themselves to the building and promoting of the new and reliable Kimdatex global name. The products quickly gain market share and are highly recommended by customers.

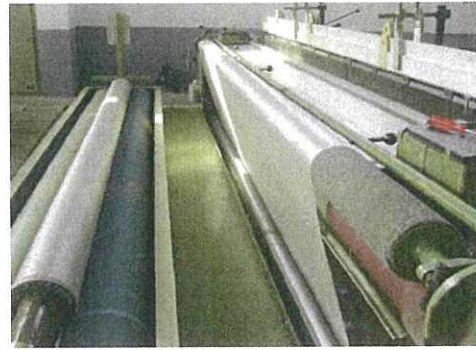

Our current production capacity is 50million square meter. Core products are geotextiles and argotextiles, carpet backing, artificial turf backing, commonly used in civil engineering works, waterworks, agricultural and environmental protection. Our products are sold widely in over 10 countries and regions of mainland China, Europe, USA and Southeast Asia.

OUR MISSION, VISION AND GOAL

The company strife to modernize and improve the efficiency based on the advanced production and technology of PROPEX, integrates a strict and better management model to maximize cost-efficiency, aggressively develop and innovate new products, enlarge product range and expand the market, matching our customers' need with a high quality and better cost efficiency.

CLIENT LIST

Major clients include:

Jiangsu Creation Artificial Turf Co.Ltd., China

MIE Investment Co., UK

Contech Products Inc. USA

Constain Carpet Co., USA

PRODUCT LIST (see attached specification)

CORE PRODUCTS INCLUDE:

PP Fibrillated Woven Fabrics, ie, carpet backing, artificial turf backing, geotextile, GCL, argrotextile.

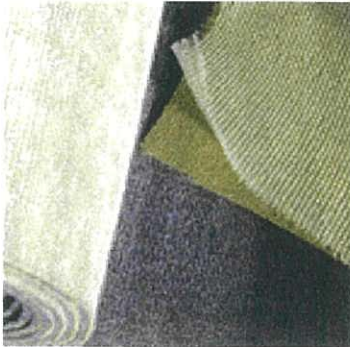

Carpet backing

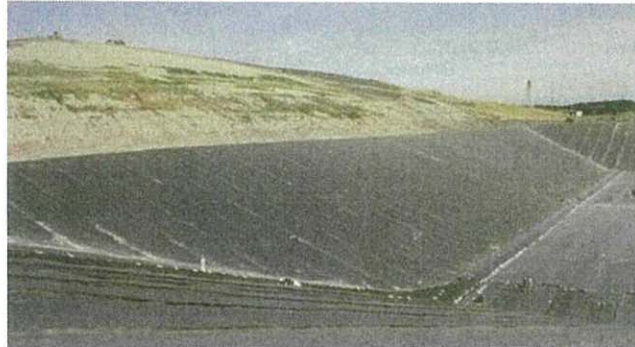

Geotextile

APPLICATION

1. Filtration and fencing
2. Separation and GCL
3. Soil reinforcement
4. Landfill
5. Landscape and drainage
6. Soft-ground stabilization

UNIQUE SELLING POINT

Our company manufactures woven geotextile, which is a geosynthetic materials, weaves from polypropylene fibrillated tape yarn, widely used in water works and civil engineering works, i.e. power plant, harbor and ports, highways, railway.

Special features of the products are:

1. **High Tensile Strength** : Due to the use of plastic tape for weaving, the materials remain strong and stretchable under wet and dry condition
2. **Durable** : do not deteriorate easily under long term exposure to various levels of acidity of mud and water
3. **High Permeability** : when the fabrics are weaved, there are controllable openings to ensure the high permeability capability

4. **Micro-organism : inert and insect proof**
5. **Easy operation : the material is light and flexible, easy to transport and install**

QUALITY CONTROL

Specific and comprehensive quality control system is adopted in production. Full implementation of ISO9001 quality management system is being undertaken. We expect to have the certification by first quarter of 2008. Internally, we use “zero defects” as our guiding principle to monitor quality control.

Every project we handle is treated with special attention, which ensures our brand range of products to test and apply to your products until they are perfect. We appreciate your comments.

Yizheng Kimda Industrial Fabrics Company Limited
No. 1 Zong San road, Xupu Industrial Area, Zhenzhou,
Yizheng City, Jiangsu
P.R. China
Tel: 86 514 83299598
Fax: 86 514 83299591
e-mail: kimdatex@gmail.com
www.kimdatex.com

Kimdatex Geotextile



Kimdatex geotextiles offers a wide, market orientated range of synthetic wovens, nonwovens and composites , for civil engineering, environmental protection and agriculture applications, utilizing the most advanced and efficient production facilities in the industry, which is ideally suited to meet the demands of today's various requirements. All Kimdatex products are the result of many years' experience in the development and manufacture of industrial textiles for technical application; we assemble the most professional team in the industry, linked with close consultation and cooperation of customers, research institutes and consulting engineers. Depending on the problems and the requirements it is possible to select from this varied range a suitable product, obtaining the quality, technical and economical solution.

Applications:

- » Stabilization of roads, railroads
- » Reinforcement and Separation
- » Landfill
- » Embankment
- » Erosion Control
- » Agricultural applications

Product Range:

- Standard CEF Geotextiles
- Standard CW Geotextiles
- Silt Fence
- Groundcover/Weedmat

Yizheng Kimda Industrial Fabrics Company Limited

#1 Zong San Road, Xupu Industrial Area, Zhenzhou,

Yizheng City, Jiangsu, P.R. China

Tel: 86 514 83299598 Fax: 86 514 83299591

Email: kimdatex@gmail.com

Website: www.kimdatex.com



Woven Geotextile
Kimdatex CEF2101

Product Specification

Standard Polypropylene CEF(flat woven) Geotextiles

Kimdatex *Geotextile*

Mechanical Properties	Testing Method	Units	CEF2080	CEF2100	CEF2101	CEF2102	CEF2103	CEF2104	CEF2105	CEF2106
Tensile Strength - MD	EN ISO 10319	kN/m	15	16	17	20	30	40	50	60
Tensile Strength - XD	EN ISO 10319	kN/m	11	12	15	20	28	32	45	50
Elongation - MD	EN ISO 10319	%	22	22	22	22	22	22	22	22
Elongation - XD	EN ISO 10319	%	14	14	14	14	13	14	14	14
CBR Puncture	EN ISO 12236	N	1500	1900	2000	2500	3000	4500	5000	6500
Hydraulic Properties										
Apparent Open Size(max)	EN ISO 12956	mm	0.1 - 0.3	0.1 - 0.3	0.1 - 0.3	0.1 - 0.3	0.1 - 0.3	0.1 - 0.3	0.1 - 0.3	0.1 - 0.3
Water Permeability	EN ISO 11058	l/m ² .sec	>15	>15	>15	>15	>15	>15	>14	>14
Physical Properties										
Mass Weight	EN 965		80	100	120	130	150	200	250	280
Roll Width		m	4.50	4.57	4.16	4.16	4.5	4.5	4.5	4.5
Roll Length		m	100	100	100	100	100	100	100	100
Full Load Volume(40'HQ)		SQ/M	180,000	160,000	130,000	120,000	100,000	80,000	60,000	56,000

*The Hydraulic values are only for reference but not ensured.

*We reserve the right to alter product specifications without prior notice.

* We can not accept responsibility for the performance of these products as the conditions of use are beyond our control.

The zealot's approach toward innovation and problem solving means there are no theoretical limits to the improvements, changes or additions we can make for your products. If you require more detailed information or you would like to advice opposite your specific requirements, please do not hesitate to contact us. **Kimdatex Geotextiles** ensures you the strength and diversity needed to create the most competitive end-use products.

Yizheng Kimda Industrial Fabrics Company Limited

#1 Zong San Road, Xupu Industrial Area, Zhenzhou,

Yizheng City, Jiangsu, P.R.China

Tel: 86 514 83299598 Fax: 86 514 83299591

Email: kimdatex@gmail.com



Woven Geotextile
Kimdatex CEF2101

Certification

仪征市金达织物有限公司

YIZHENG KIMDA INDUSTRIAL FABRICS CO.,LTD.

江苏省仪征市胥浦工业集中区纵三路一号

#1,ZONG SHAN ROAD,XUPU,YIZHENG,JIANGSU, P.R.CHINA

TEL:86-514-83299589 FAX:86-514-83299591

July 23, 2008

To Whom It May Concern

Propex 2001 is a product originated from Amoco Fabrics & Fibers Co, USA. Yizheng Amoco Fibre Co Ltd was established in 1991 by the joint venture of Amoco Fabrics & Fibers Co, USA and Sinopec Yizheng Chemical Fibre Co Ltd, PRC. The joint venture has since produced Propex 2001 geotextile under the product name of CEF2001.

Since August 1, 2002, Yi Hua International Investment, a subsidiary of Sinopec Yizheng Chemical Fibre Co Ltd has acquired the shares of Amoco Fabrics & Fibers Co in the Yizheng Amoco Fabric Company joint venture and renamed the company as Yihua Polytiles Co Ltd continuing the business subsidiary.

Propex 2001 woven geotextile has been renamed as CEF2001 under the change of ownership agreement between Yihua and BP Amoco Holdings. From December 2004, Bonar Technical Fabrics, Belgium has acquired Yihua Polytiles Company Limited and continued the production of geotextile.

However Bonar Yihua is planning to discontinue the geotextile production. Yizheng Kimda Industrial Fabrics Company Limited is taking over the manufacturing. There has been no change to the production, specification, quality and QA program to CEF2001 geotextile which has been relabeled as CEF2101 for identity.

Authorized Signature

General Manager: April Shao

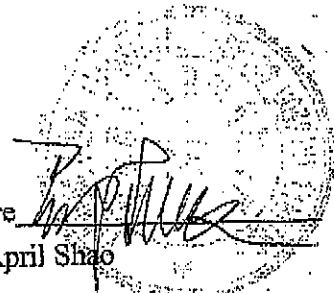



Quality Management System Certificate of Approval

This is to certify that the Quality Management System of

Yizheng Kimda Industrial Fabrics Company Limited

No.1 Zhongsan Road, Xupu Industrial Area, Zhenzhou, Yizheng City, Jiangsu, P.R.China

Has been assessed and found to meet the requirements of

ISO 9001:2008

Production and Service of the Carpet Base Fabric, Artificial Turf Special Base Cloth, Slit and Split Film Yarn Woven Geotextiles, Agricultural Environmental Protection Cloth

Certificate Number: **Q04110865**

Date of Issue: 05, August, 2011

Valid until: 04, August, 2014

Authorized by:

Senior Executive



*This Certificate is the Property of DAS Certification
The validity of the registration will be continued only
when the organization pass the annual surveillance
audit. Check the validity of certificate at www.das-china.com
Surveillance Audits*



Shanghai DAS Certification Co., Ltd

Address: 505, Tower 2, Guosheng Center, No.388 Zhongyuan Road, Shanghai, P.R. China Post Code: 200062
Tel: 0086-21-62773910 Fax: 0086-21-62080319 Website: <http://www.das-china.com> Email: info@das-china.com

DIRECT ASSESSMENT SERVICES

仪征市金达织物有限公司

YIZHENG KIMDA INDUSTRIAL FABRICS COMPANY LIMITED.

No.1 ZONG SAN ROAD,XUPU INDUSTRIAL AREA,

ZHENZHOU,YIZHENG CITY, JIANGSU,CHINA

TEL:86-514-83299589 FAX:86-514-83299591

CONFORMANCE CERTIFICATE

Jan. 18, 2012

INVOICE NO.: 11KY052G&E

We hereby certify that civil engineering mat style CEF2101 shipped to you on December 14, 2011, by vessel ASIA ZEPHYR V.1154S,meet the following minimum average roll values.

Property	Test Method	Average Roll Value
Mass Per Unit Area	ASTM D5261-92	120.1gsm/sqm
Wide Width Tensile Strength	ASTM D4595-86	9.1kN/M
Elongation at Failure	ASTM D4595-86	25.6%
Trapezoidal Tear Strength	ASTM D4533-91	322N
Grab Tensile Strength	ASTM D4632-91	519N
AOS(0 _{cc})	ASTM D4751-99	70um
Permittivity	ASTM D4491-99	0.70 SEC ¹

The values are a result of testing conducted in on-site laboratories at the time of production under the test standard. Test data is retained in the Quality Control files of Kimdatex's production facility.

Meng Qing Bin
Manager of Quality Control Department
Yizheng Kimda Industrial Fabrics Co.Ltd.





Woven Geotextile
Kimdatex CEF2101

Installation Guideline

HANDLING AND STORAGE OF GEOTEXTILE

Introduction

Geotextiles must be handled and stored properly to assure that the specified physical properties are retained to serve project needs.

Handling and Storage

Standard Guide for Identification, Storage and Handling of Geotextile as in ASTM D4873 is to be followed.

Site Unloading

Geotextile rolls may be lifted using nylon straps or rope and a crane, backhoe, or bulldozer.

Site Handling

Dragging the geotextile and operating equipment on the geotextile should be avoided at all times.

Site Storage

If stored outdoors, the geotextile should be elevated from the ground surface and covered with a tarpaulin or opaque plastic. Rolls should be kept dry during storage. Exposing geotextile rolls to moisture or water prior to installation can lead to serious handling problems.

Protective Wrapping Damage

If the outer layer of the geotextile itself is damaged, it is permissible during installation to remove the outermost wraps of the roll and discard the damaged material.

Exposure To Ultraviolet Light

It is advisable to limit geotextile exposure to sunlight until just before installation.

Geotextile exposure to ultraviolet light be limited to a time period of approximately two weeks or as directed by the engineer.

Exposure to Extreme Temperatures

It is generally recommended to limit long-term exposure of geotextiles to temperatures over 93° C.

Site Preparation

The installation area shall be prepared by clearing all debris or obstructions which may damage the geotextile. In most cases, all native vegetation, roots and topsoil must be removed from the subgrade prior to geotextile placement.

Geotextile Placement

Prior to placement of the geotextile, the surface will be prepared to a smooth condition free of debris, depressions or obstructions which may damage the geotextile. The geotextile shall be placed loosely not excessively stretch or tear upon placement of fill (not taut) with no wrinkles or folds. Care will be taken to place the geotextile in intimate contact with the soil so that no void spaces occur between the geotextile and the subgrade. Overlap or anchoring may be required as determined by the engineer. The upstream geotextile shall be overlapped over the downstream. The geotextile shall be unrolled as smoothly as possible on the prepared subgrade.

Geotextile rolls shall be overlapped or seamed in accordance with the requirements. Overlapping shall have a minimum of 450 mm except where placed underwater where the overlapping shall be 1,000 mm. Sewing is recommended where subgrade soils exhibit a CBR less than 0.5 and is preferred where subgrade soils exhibit a CBR greater than 0.5 but less than or equal to 1.0.

If required, the geotextile may be held in place prior to subbase placement with pins (on slopes), sand bags, or piles of fill or rock. On curves, the geotextile may be folded or cut to conform to the curve. If site conditions require geotextile seaming, the geotextile shall be cut and seamed on the curve. The geotextile shall not be dragged across the subgrade.

Care shall be taken during construction to avoid contamination of the geotextile with soil or other material. Contaminated geotextile shall be removed and replaced.

Damaged geotextiles, as identified by the engineer, shall be repaired immediately. The damaged area plus an additional one meter around the damaged area shall be cleared of all fill material. A geotextile patch extending beyond the perimeter of the damage shall be

constructed as directed by the engineer. Sewing of a geotextile patch may be required over soft subgrades as directed by the engineer.

Fill Placement

Fill shall be placed on the geotextile in a manner which prevents damage to the geotextile. Placement of fill shall proceed immediately following placement of the geotextile. The geotextile shall be covered with a minimum of 300 mm of loosely placed fill prior to compaction.

Aggregate Placement

The aggregate base or subbase shall be placed by end dumping adjacent to the geotextile or over previously placed aggregate. End dumping or tail gate dumping of aggregate on the geotextile will not be permitted. The aggregate shall be spread from the backdumped pile using a bulldozer or motor grader. A sufficient thickness of aggregate should be in place prior to dumping to minimize the potential of subgrade pumping and localized subgrade failure.

The aggregate shall be placed on the geotextile in lifts not less than 150 mm thick. Traffic shall not be permitted directly on the geotextile. Sudden stops or turns by equipment operating on aggregate placed over the geotextile shall be avoided. A smooth drum roller shall be used to achieve specified density.



Woven Geotextile
Kimdatex CEF2101

List of Project Reference



Yizheng Kimda Industrial Fabrics

Date	Project	Client	Consultant	Style	Quantity (Sqm)
Feb-87	HY/84/28 Lok Ma Chau Border Reclamation	Korean Shipbuilding & Engineering Corp	Binnie & Partners Ltd	2001	92,727
May-87	TPF/12/82 Fanling Development Package 4	Marple International Limited	Maunsell Consultants Asia Ltd	2001	23,870
Jun-87	TPF/27/85 Tai Po Area 6, Formation, Roads & Drainage & River Training	Skanska AB	Maunsell Consultants Asia Ltd	2001	50,050
Sep-87	Local sales	Wah Loong Metal & Building Material	-	2001	770
Nov-87	TPF/21/85 Tai Po Area 24B & 33 Formation & Seawall, Road D1 & D2	China State Construction & Engineering Corporation	Maunsell Consultants Asia Ltd	2001 2002	42,350 13,800
Dec-87	Open Space Area 37 Kwai Chung	Yiu Wing Construction Co Ltd	-	2002 2001	600 6,930
Jan-88	Queensway Office Building	Harbour Construction Limited	Pypun Group Consultants	2001	770
Jan-88	ST/24/85 Route 5, Shatin Connection Phase II	Shui On Civil Contractors Limited	Maunsell Consultants Asia Ltd	2001	29,390
Mar-88	NTDB/33/85 Tin Shui Wai Development Land Formation & Drainage	China State Construction & Engineering Corporation / B + B JV	Binnie & Partners Ltd	2002	69,000
Apr-88	TPF/26/85 Shek Wu Hui, Package 4, Area 3, Formation, Road & Drains	China Fujian Corporation Hop Kin Engineering Development Ltd	Maunsell Consultants Asia Ltd	2001	30,800
May-88	NTDB/26/85 Tin Shui Wai Drainage Works, Phase I	China International Water & Electricity Corporation	Binnie & Partners Ltd	2001	770
Jun-88	Macau Trotting Club	Shun Tak Construction Company	Maunsell Geotechnical Services Ltd	2001	44,660
Jun-88	HY/87/01 NT Circular Road Improvement, Phase 4 - Au Tau, Fan Kam Rd & Fairview Park	Infra-Int'l Foundation & Realty Associate Co Ltd	Binnie & Partners Ltd	2001	6,160
Aug-88	JB/25/86 Junk Bay Development - Hang Hau Area, Stage II Engineering Works	Aoki Corporation Lau Cheong Kee Marine Engineering Ltd	Maunsell Consultants Asia Ltd	2001 2002	100,100 30,000
Sep-88	Hydroseeding Cover	Oriental Environmental Services Ltd		RFX5000	1,000
Sep-88	Hydroseeding Cover	Blora International Ltd		RFX5000	1,000
Sep-88	TPF/36/86 Fanling South - Stage II Formation Roads & Drainage	Chun Wo Construction & Engineering Co Ltd	Maunsell Consultants Asia Ltd	2001	23,870
Feb-89	TPF/24/85 Ting Kok Road Upgrading	China Harbour Engineering Company	Maunsell Consultants Asia Ltd	2001 2002	20,000 20,000
Jan-89	ST/45/87 Shatin Road T6 & Interchange	Shui On Civil Contractors Ltd	Maunsell Consultants Asia Ltd	2001 2002	17,710 6,000
Mar-89	Tsing Yi Shell Terminal	Franki Kier Ltd	-	2002	600



Apr-89	ST/49/88 Ma On Shan Phase II, Contract F, Shatin Road T5, T7, D17 & Interchange	Shui On Civil Contractors Ltd	Maunsell Consultants Asia Ltd	2001	93,940
Aug-89	JB/17/86 Junk Bay Development	Lau Cheung Kee Marine Engineering Ltd	Maunsell Consultants Asia Ltd	2001 2002	97,020 20,400
Jan-90	ST/47/88 Ma On Shan Phase II, Contract P, Roads & Drains	Kin Shing Construction Company Ltd	Maunsell Consultants Asia Ltd	2001	154,000
Feb-90	14/WSD/88 Water Works Maintenance	Wo Hing Engineering Co Ltd	Water Supplies Department	2001	770
Feb-90	FL/3/86 Fanling Development Package 6, Area 39 Formation, Roads & Drains	Kin Shing Construction Company Ltd	Maunsell Consultants Asia Ltd	2001	10,000
Apr-90	FL/10/89 Fanling South - Stage IV Formation, Roads & Drains	Shun Yuen Construction Co Ltd	Maunsell Consultants Asia Ltd	2001	10,000
Jun-90	HY/88/26 Kowloon Park Drive Flyover & Associated Road Improvement	Shui On Civil Contractors Ltd	Maunsell Consultants Asia Ltd	2001	3,850
Aug-90	Stonecutter Island Sewage Treatment Plant	Leighton - Lama Joint Venture	Montgomery Watson HK Ltd	2002	1,800
Aug-90	TK/30/89 Tseung Kwan O, Area 48 & 59 Reclamation & Road Works	Universal Dockyard Ltd	Maunsell Consultants Asia Ltd	2001	210,980
Oct-90	TPF/30/86 Tai Po Fanling Development	Chun Wo Construction & Engineering Co Ltd	Maunsell Consultants Asia Ltd	2001	3,080
Oct-91	FL/12/89 Shek Wu Hui, Package 4 & 5, Area 1, 2A & 3 Footbridge & River Training	Sung Foo Kee Civil Ltd	Maunsell Consultants Asia Ltd	2001	47,310
Nov-91	Hydroseeding Cover	Gammon Construction Ltd	-	RFX5000	10,000
Mar-92	ST/54/89 Shatin New Town, Stage Stage II, Servicing & Minor Formation in Tai Shui Hang Village	China Road & Bridge Corporation	Maunsell Consultants Asia Ltd	2001	11,550
Nov-92	HKHA/32/92 Pak Tin Estate Development	Luen Cheong Tai Construction Co Ltd	Hong Kong Housing Authority	2001	770
Dec-92	CV/89/17 Tolo Harbour Effluent Tunnel	Vianni Seli Ltd	Montgomery Watson HK Ltd	2001	770
Dec-92	TWTL 323 Yau Kam Tau Development	Chun Wo Construction & Engineering Co Ltd	-	2001	6,530
Dec-92	TP/20/92 Tai Po Development Formation & Servicing Area 31	Luen Cheong Tai Construction Co Ltd	Maunsell Consultants Asia Ltd	2001	10,300
Dec-92	TMTL 73 Tuen Mun Development	Chun Wo Construction & Engineering Co Ltd	-	2001	770
Jan-93	TK/34/91 Tseung Kwan O Area 55, 56, 57 Reclamation & Drainage Works	Aoki Corporation	Maunsell Consultants Asia Ltd	2001 4553 4551	669,972 43,754 3,809
Jan-93	CV/90/06 Aldrich Bay Typhoon Shelter Reclamation	China Harbour Engineering Company Ltd	Civil Engineering Department	2001	245,679



Feb-93	FL/15/92 Shek Wu Hui Development Package 4, Area 30B Box Culvert	G & G (JV) Contractors Ltd	Maunsell Consultants Asia Ltd	2001	4,547
Apr-93	TP/19/92 Tai Po Development, River Training in Area 6 & Servicing in Area 37	CKCE Co Ltd	Maunsell Consultants Asia Ltd	2001	7,800
Apr-93	EP/SP/10/91 SENT Landfill, Tseung Kwan O	Leighton Contractors (Asia) Ltd	Rust Asia Pacific Ltd	4506 4551 1198 2001 2001	1,667 2,926 19,575 11,042 20,640
		Green Valley Landfill, Limited			
Jul-93	CV/92/11 East Sha Chau, Capping & Management, Mud Pit 1	Universal Dockyard Ltd	Civil Engineering Department	6074 6274	8,320 10,400
Jul-93	UA/9/91 West Kowloon Reclamation	Leighton/CSCEC/Van Oord/Lau Cheung Kee JV	Mott MacDonald HK Ltd	2001 2000	650 6,495
Dec-93	TP/24/93 Tai Po Development	Hoi Shing Construction Co Ltd	Maunsell Consultants Asia Ltd	2001	7,794
Jan-94	UA/9/91 West Kowloon Reclamation	Ever Shine Engineering Ltd	Mott MacDonald HK Ltd	2001	1,950
Mar-94	ST/65/92 Shatin Development Phase II, Contract J, Part 1	Hoi Shing Construction Co Ltd	Maunsell Consultants Asia Ltd	2001	35,723
Mar-94	FL/15/92 Fanling Development	Union Contractors Ltd	Maunsell Consultants Asia Ltd	2001	5,850
Apr-94	KCRC Project	Pollard Construction Ltd	-	2001	650
Apr-94	Tuen Mun Development	Hoi Shing Construction Co Ltd	Scott, Wilson & Kirkpatrick	2001	650
Jun-94	China Light & Power Ltd Cable Works	Kum Shing (KF) Construction Co Ltd	-	2001	650
Jun-94	CV/93/09 East Sha Chau, Capping & Management, Mud Pit 2	Universal Dockyard Ltd	Civil Engineering Department	6074	20,800
Oct-94	TK/36/93 Tseung Kwan O Area 65, 66, 67 & 68 Reclamation, Drainage & Seawall	Kin Shing Construction Lam Construction JV Geoworks Contractors (HK) Ltd	Maunsell Consultants Asia Ltd	2001 2000	413,083 137,694
Oct-94	NKIL 5924 Beacon Hill Development	Sang Hing Civil Contractors Co Ltd	Maunsell Consultants Asia Ltd	2001	45,465
Jan-95	TK/38/93 Tseung Kwan O Reclamation in Area 86	Aoki Corporation Geoworks Contractors (HK) Ltd	Maunsell Consultants Asia Ltd	2000	411,134
Mar-95	MTRC 518 Siu Ho Wan Depot, Phase 1	Shul On Civil Contractors Ltd	Maunsell Consultants Asia Ltd	4516 2002	9,197 20,400
Apr-95	MTRC 509 Kwai Chung Park Viaduct	GTM-Wan Hin-CEF JV China Harbour Engineering Company Pacific Island Engineering Ltd	Babtie Oakervee MTR Corporation	4516 4551 6074	62,318 8,887 4,160
May-95	TP/27/93 Tai Po Development	Luen Cheong Tai Construction Co Ltd Multiways Contractors Ltd	Maunsell Consultants Asia Ltd	2001	12,990
Jun-95	CV/94/06 Tuen Mun Area 38 Special Industrial Area	Wai Kee Marine Engineering & Transportation Ltd	Civil Engineering Department	2001	220,181



Sep-95	CV/95/04 East Sha Chau, Capping & Management, Mud Pit 3	Geoworks Marine Contractors Ltd	Civil Engineering Department	6274 6074	4,160 18,221
Oct-95	ST/64/92 Shatin Development	Luen Cheong Tai Construction Co Ltd Multiways Contractors Ltd	Maunsell Consultants Asia Ltd	2001 2001	2,598 1,299
Nov-95	NKIL 5924 Beacon Hill Development	Fieldworks Contractors Co Ltd	Maunsell Consultants Asia Ltd	2001	1,299
Dec-95	NKIL 5924 Beacon Hill Development	Sunrise Construction Company	Maunsell Consultants Asia Ltd	2001	3,898
Apr-96	FL/18/95 Sutej River Training, Stage II Flood Protection Scheme for Tsung Pak Long & Tai Tau Leng	Sang Hing Civil Contractors Co Ltd Ching Chit Cheung Construction Co Ltd	Maunsell Consultants Asia Ltd	2001	77,941
May-96	CV/95/55 Construction of Ferry Berth at Sok Kwu Wan, Lamma Island	Ho Hon Engineering Co Ltd	Civil Engineering Department	6074	1,040
Oct-96	15/WSD/95 Pokfulam Pumping Station	Univic Engineering Ltd	Civil Engineering Department	6074 6086	520 1,560
Dec-96	9/WSD/96 Term Contract for Waterworks, Lantau District	Yick Hing Construction Company	Water Supplies Department	2001	1,299
Feb-97	ST/72/94 Ma On Shan Development Phase II	China Fujian Engineering(HK) Ltd	Maunsell Consultants Asia Ltd	2001	9,743
May-97	EP/SP/28/95 Urban Landfill Restoration	Hong Kong Landfill Restoration Group Ltd Steel Dragon Enterprise Co Ltd	Babtie BMT Golder & Associates	2001 4551	1,299 1,260
Jun-97	TK/40/94 Tseung Kwan O Development, Ying Yip Road	Geoworks Equipment Co Ltd Beijian Jian Long Construction Engineering JV	Maunsell Consultants Asia Ltd	2001 2001	16,887 4,800
Jun-97	Area 50 & 51, Tseung Kwan O, Civil Engineering Works, Package I & II Seawall and Reclamation	Geoworks Equipment Co Ltd	Maunsell Consultants Asia Ltd	2000	29,877
Sep-97	EP/SP/19/94 Outlying Islands Transfer Facilities	Superstar Contractors Ltd	Ove Arup & Partners HK Limited	4551 6088 6083	4,209 1,040 1,560
Nov-97	28/WSD/96	Chau Mo Engineering Company	Water Supplies Department	6074	520
Feb-98	IS/8/97 Tai O Development Package 3, Stage II	Rich Sea Construction Engineering Co Ltd Beijian Jian Long Construction Engineering JV	Wilbur Smith Associates Ltd	2002	10,800
Apr-98	River Trade Terminal	Zen Pacific - Dredging International Joint Venture	Scott Wilson (HK) Ltd	6083	1,575
May-98	CV/97/03 Pak Shek Kok Reclamation for Dumping, Stage II	Dickson Construction Co Ltd	Civil Engineering Department	6088	362,960
Sep-98	TK/42/96 Engineering Infrastructure in Tseung Kwan O Town Centre	B + B Construction Co Ltd	Maunsell Consultants Asia Ltd	2001	48,064
Jan-99	Lam Tin Development	PMS Engineering Ltd	Hong Kong Housing Authority	2001	1,299



Jan-99	Contract No 99 of 1996 Tseung Kwan O Development	China State Construction Engineering Co Ltd	Hong Kong Housing Authority	2001	12,959
Apr-99	FL/22/98 Main Drainage Channel for Fanling, Sheung Shui, Hinterland River Training Works for Lower River Indus and River Beas	Sang Hing Civil Contractors Co Ltd China State Construction Engineering Corporation	Maunsell Consultants Asia Ltd	2001	252,810
May-99	HY/98/02 Widening of Tolo Highway between Island House and Ma Liu Shui	Good View Construction Engineering Ltd Hong Kong Construction (Holdings) Ltd	Maunsell Consultants Asia Ltd	2001 2001	33,750 6,450
Jun-99	CV/98/07 Deployment of Concrete and Quarry Rock Artificial Reef Units in Yan Chau Tong Marine Park	Fortress Development Ltd Law Chi Yip Construction Co Ltd	Civil Engineering Department	6088	1,040
Jun-99	TK/43/96 Tseung Kwan O Development Widening and Improvements of Wan Po Road	Bright View Engineering Limited	Maunsell Consultants Asia Ltd	2001	12,000
Aug-99	ST/75/97 Sha Tin Town Development	Wing Fai Construction Co Ltd	Maunsell Consultants Asia Ltd	2001	18,465
Aug-99	ST/82/99 Sha Tin New Town Stage II Contract for Ma On Shan Development Phase 2, Contract J, Part 2	Tsun Yip Waterworks Construction Co Ltd	Maunsell Consultants Asia Ltd	2001	2,400
Sep-99	RP/03/96 Rural Planning & Improvement Strategy Minor Rural Improvement Works, Package IC	Kin Shing Construction Co Ltd	Mouchel Asia Ltd	6088	1,560
Dec-99	FL/23/99 Main Drainage Channels for Fanling, Sheung Shui and Hinterland	Guangshing Civil Engineering Co Ltd	Maunsell Consultants Asia Ltd Mouchel Asia Ltd	2001	250,035
Dec-99	TK/48/99 Tseung Kwan O Box Culvert Construction	Bright View Engineering Limited	Maunsell Consultants Asia Ltd	2001	3,225
Dec-99	KCRC West Rail - CC302 Tsuen Wan Reclamation	Sino-European Joint Venture	Atkins (China) Ltd	2001	1,290
Jan-00	Tseung Kwan O Contract No. 97 of 1996 Site Formation and Associated Works for Tiu Keng Leng	China State Construction Engineering Corporation	Hong Kong Housing Authority	2001	645
Feb-00	EP/SP/30/95 NWNT Landfills and Gin Drinkers Bay Landfill Restoration	Gammon Construction Limited	Binnie & Partners Ltd	2000	645
Feb-00	23/WSD/97 Extension of Water Supply to Ma On Shan	Downer Construction (HK) Ltd	Maunsell Consultants Asia Ltd	2000	1,290
Mar-00	CV/98/13 Reconstruction at Tung Lung Chau Public Pier Sai Kung and Construction of Pier near Tai Pak Kok	Fortress Development Limited Law Chi Yip Construction Co Ltd	Civil Engineering Department	6088	5,200
May-00	HAD No.RP/3C/98 Rural Planning & Improvement Minor Rural Works, Package 3C	Kwan Shing Engineering & Construction Co Ltd Hong Kong & Macau Scent On Engineering & Construction Ltd	Mouchel Asia Ltd	6088	2,600
Jun-00	CV/98/01 Pak Shek Kok Reclamation Phase 3	Billion Rich Engineering Ltd	Maunsell Consultants Asia Ltd	2001	12,900



Jul-00	CV/98/11 Construction of Box Culvert Along Shung Shun Street, Lei Yue Mun	Hung Piu Development Ltd	Civil Engineering Department	2001	1,290
Aug-00	TK/45/2000 Tseung Kwan O Development Phase 3	China Civil Engineering Construction Corporation	Maunsell Consultants Asia Ltd	2001	90,300
Oct-00	CV/99/12 Penny's Bay Reclamation Stage 1	HAM Dredging and Marine Contractors Good View Construction Engineering Ltd	Scott Wilson (Hong Kong) Ltd	2001 6088 2001	5,805 6,000 6,450
Nov-00	Private project	Netten Construction Co Ltd		2001	1,290
Nov-00	RP/3D/98 RPIS Rural Improvement Works, Package 3D	Hong Kong & Macau Scent On Engineering & Construction Ltd	Mouchel Asia Ltd	6088	1,560
Dec-00	Lamma Island	Ho Hon Construction & Engineering Ltd	Hong Kong Electric Co Ltd	2001	3,870
Jan-01	CV/2000/01 Tuen Mun Area 38 Reclamation Stage II	Penta-Ocean Construction Co Ltd	Civil Engineering Department	6088	340,600
Feb-01	TIE/4/2000 Fat Tau Chau Village Resite Extension	Yick Hing Construction Co Ltd	Maunsell Consultants Asia Ltd	2001	645
Feb-01	Cyberport Development	Friendly Benefit Engineering Ltd	Maunsell Consultants Asia Ltd	2001	645
Feb-01	ST/81/99 Sha Tin New Town Development Stage II	China Civil Engineering Construction Corporation	Maunsell Consultants Asia Ltd	2001	5,805
Mar-01	Lamma Reclamation	China Infrastructure Consultants Ltd Hong Kong River Engineering Co Ltd	Hong Kong Electric Co Ltd	6088 2001	61,360 9,030
Apr-01	TK/52/2000 Tseung Kwan O Development Completion Contract for Contract No. TK40/94 - Improvement to Ying Yip Rd and Silverstrand Beach Rd	Compile Engineering & Construction Ltd	Maunsell Consultants Asia Ltd	2001	2,580
May-01	CV/99/12 Penny's Bay Reclamation Stage 1	HAM - MWS	Scott Wilson (Hong Kong) Ltd	6088	10,000
Jun-01	CV/2000/04 Reconstruction of Tai Lam Chung Pier, Hei Ling Chau Pier and Kadoorie Pier	Hung Piu Development Ltd Hong Kong & Macau Scent On Engineering & Construction Ltd Hong Kong Land & Marine Contractors Ltd Lap Kai Engineering Co Ltd	Civil Engineering Department	6088 6088 6088 6088	1,040 520 2,980
Jun-01	CV/2000/04 Reconstruction of Tai Lam Chung Pier, Hei Ling Chau Pier and Kadoorie Pier	Kwan Sing Engineering & Construction Co Ltd	Civil Engineering Department	6088	1,040
Sep-01	CV/99/10 Pak Shek Kok Reclamation for Public Filling, Remaining Works	Kumagai Gumi Co Ltd	Civil Engineering Department	6088	1,040
Oct-01	FL/26/01 River Training for Upper Indus - Completion of the Remaining Works between Man Kam to Road and KCRC Bridges	Sun Fook Kong (Civil) Ltd	Maunsell Consultants Asia Ltd	2001	416,610
Oct-01	NL/9/98 Tung Chung Development Phase 3A, Reclamation for Area 51, 52 (Part), to 56	Forbes Engineering Ltd	Mott Connell Ltd	2001	8,385



Nov-01	CV/2000/09 Infrastructure for Penny's Bay Development, Contract I	Cheery City Contractors Ltd China State Construction Engineering Corporation Adventure Engineering Ltd	Maunsell Consultants Asia Ltd	6088 2001 2001	16,640 646,328 9,945
Jan-02	CV/97/01 Tseung Kwan O Port Development at Area 137 Stage 2 Construction of Seawalls & Reclamation	Chevalier Civil Engineering (Hong Kong) Ltd	Maunsell Consultants Asia Ltd	2001	64,500
May-02	HY/99/18 Castle Peak Road Improvement between Sham Tseung and Ka Loon Tsuen, Tsuen Wan	Maeda Corporation	Mouchel Asia Ltd	6088	7,410
Aug-02	CV/2001/04 Reclamation of Ma Liu Shui Interchange & Reprovisioning of Existing Pier	Billion Rich Engineering Limited Zhuhai International Economic & Technical Co-operation Corporation	Civil Engineering Department	6088 6088 2001	25,740 15,080 13,260
Aug-02	CV/2001/05 Reclamation Works in North Tsing Yi	Gammon Skanska Limited	Civil Engineering Department	6088	69,092
Sep-02	FL/27/02 Completion of the Remaining River Training Works for Upper River Indus between Man Kam To Road and San Wai	Bilfinger Berger AG	Maunsell Consultants Asia Ltd	2001	420,130
Dec-02	TK/57/02 Tseung Kwan O Development, Phase II Grade Separated Interchange T1/P1/P2	China Civil Engineering Construction Corporation	Maunsell Consultants Asia Ltd	2001	48,900
Feb-03	HY/2000/02 Castle Peak Rd Improvement between Area 2 and Ting Kau, Tsuen Wan	China State Construction Engineering (Hong Kong) Ltd	Mouchel -Halcrow JV	6088	1,040
Mar-03	Private project	Chok Chee Kee Building Contractor		2001	645
Mar-03	LDB-201 East Rail Extensions Lok Ma Chau Spur Line Sheung Shui to Chau Tau Tunnels	Dragages (HK) Joint Venture	Ove Arup & Partners HK Ltd	2001	645
Mar-03	Disney's Hollywood Hotel, Penny Bay	Shui Wing Engineering Co Ltd	Maunsell Consultants Asia Ltd	2001	6,450
Apr-03	CV/2002/09 Tai O Development - Sheltered Boat Anchorage	China Harbour Engineering Company (Group)	Maunsell Consultants Asia Ltd	6088 2001	520 93,870
May-03	ST/89/02 Route 9 Shatin Height Tunnel & Approaches	Hin Sum Engineering Company Limited	Maunsell Consultants Asia Ltd	2001	645
Sep-03	CV/2001/10 Infrastructure for Penny's Bay Development Contract 2	China State Construction Engineering (Hong Kong) Ltd	Civil Engineering Department	2001	75,762
Sep-03	CV/2002/04 Penny's Bay Reclamation Stage 2	Gammon Skanska Limited Shun Tat Construction Engineering Ltd	Scott Wilson Ltd	6088 2001	15,600 10,808
Sep-03	Chi Ma Wan Cable Tunnel Tai Long Wan Marine Works (Stage 9)	Good View Construction Engineering Ltd	Atkins China Ltd	2001	3,870
Nov-03	HY/2002/21 Shenzhen Western Corridor	Gammon Skanska Limited	Ove Arup & Partners HK Ltd	6088	17,680



Jan-04	HY/2003/01	Tung Yat Construction Co Ltd	Maunsell Hyder	2001	8,586
	Route 9 - Lai Chi Lok Viaduct Package of	Necso Entrecanales Cubiertas, SA	Joint Venture	2001	630
	Realigned Channel at Wai Man Tsuen	Union Construction Ltd		2001	1,919
		Allied States Engineering Ltd		2001	6,999
Mar-04	132 KV Submarine Cable Circuits from		Hong Kong	6088	2,600
	Cheung Chau to Tai Long Wan	Hong Kong Land & Marine Contractors Ltd	Electric Co Ltd		
Apr-04	HY/2002/23		Ove Arup & Partners	2001	1,890
	Deep Bay Link - Southern Section	Ming Shing Construction Engineering Co Ltd	HK Ltd		
Apr-04	Lamma Channel Dredging	Howin Engineering Limited	Hong Kong	6088	520
			Electric Co Ltd		
Apr-04	Pok Oi Hospital	Hsin Chong Construction Co Ltd		2001	630
May-04	Australian Project	Apex Envirocare		2001	10,710
May-04	Lamma Channel Dredging	Penta Ocean Construction Co Ltd	Hong Kong	6088	1,560
			Electric Co Ltd		
Jun-04	10/lands/03	Kin Shing Construction Co Ltd	Lands	2001	630
	Yung Village - Nam Pin Wai		Department		
Jul-04	03/8013	Leader Marine Contractors	Hyder Consulting	6088	2,080
	Civil Works for Additional Transmission	Limited	Ltd		
	System for Lamma Power Station 275KV				
	Cable Route from Lamma Island to				
	Cyberport				
Jul-04	Subic Bay Port Development	Kwan Sing Engineering & Construction Co		2001	2,520
	Philippines	Ltd		6084	74,360
Nov-04	02/8/001	Top Union Engineering Ltd	Hong Kong	6088	1,560
	Shum Wan Road		Electric Co Ltd		
Dec-04	MTRC 584	Yee Sun Garden Ltd		2001	1,326
Dec-04	HY/99/19	Wo Yun Company Limited	Mouchel Halcrow	2001	663
	Castle Peak Road Improvement between		JV		
	Ting Kau and Sham Tseng, Tsuen Wan				
May-05	HK/12/02	Best Leader Engineering Ltd	Atkins China Ltd	2001	18,900
	CED, Central Reclamation Phase III,	Leighton - China State - Van Oord JV		2001	60,038
	Engineering Works			2101	29,120
Jun-05	TP/37/03	Leader - Wai Kee (C&T) Joint Venture	Hyder Consulting	2001	10,191
	Remaining Engineering Infrastructure		Ltd		
	Works for Pak Shek Kok Development				
	Package 2A				
Aug-05	EP/SP/12/93	Hin Sum Engineering Co Ltd	Halcrow China Ltd	2001	2,652
	(NENT) Landfill				
Sep-05	KCRC - LCC300	Arbat Construction Co Ltd	Mott Connell Ltd	2001	6,300
	East Rail Extensions Lok Ma Chau				
	Terminus & Associated Works				
Feb-06		Ka Shun Civil Engineering		2001	3,780
	Carcass Work Contract for the Proposed	Company Limited	Maunsell Consultants		
	Residential Development (Package 1)		Asia Ltd		
	TKOTL No. 70 Area 86, Site F, TKO, NT				
Mar-06	MTRC 5036	Tung Yat Construction Co Ltd	Mott Connell Ltd	2001	1,260
	Tung Chung Noise Barriers	NESCO			
Jun-06	The Hong Kong Jockey Club	Best Union Engineering Co Ltd	Atkins China Ltd	2001	5,118
	Reconstruction of Settled Service Road				
	and Storm Drain at Sha Tin Racecourse				
Aug-06	ST/2005/02	Penta Ocean - Peako JV		2001	1,280
	Shatin New Town, Stage II Road Works at		Maunsell Consultants		
	Areas 34 & 52 in Shui Chuen O & Area		Asia Ltd		
	56A in Kau To				



Sep-06	DC/2005/10 Drainage Improvement Works at Yung Shue Long New Village in Lamma Island, Tseng Lan Shue in Sai Kung and Shui Lau Hang in Tak Kwu Ling	Univic Engineering Limited	Scott Wilson Ltd	2001	6,349
Sep-06	CV/2004/09 Reconstruction of Sha Tau Kok, Wong Shek and Ko Lau Wan Public Piers	China Harbour Engineering Company (Group)	Civil Engineering and Development Department	2001	640
Oct-06	MTRC 617 Tseung Kwan O South Station and Approach Structure	Maeda Corporation	Maunsell Consultants Asia Ltd	2001	11,516
Mar-07	HY/2005/06 Castle Peak Road Improvement - West of Tsing Lung Tau	Shun Tat Construction Engineering Limited	Mouchel Halcrow JV	2001	640
May-07	CV/2004/05 Dredging Maintenance	China Harbour Engineering Co Ltd	Civil Engineering and Development Department	2001	1,890
Jun-07	CV/2006/06 Seawall Upgrading Works for Ma On Shan Waterfront Promenade	Shun Tat Construction Engineering Limited	Mannings (Asia) Consultants Ltd	2001	8,190
Aug-07	GE/2005/45 Landslide Preventive Works at Po Shan Road, Mid-Levels	Kenly Engineering Limited	Maunsell Geotechnical Services Ltd	2001	630
Aug-07	DC/2006/06 Drainage Improvement Works in Kwu Tung South and Fu Tel Au, Sheung Shui	Kwan Lee (International) Engineering Co Ltd	Mott Connell Ltd	2001 2101	19,203 582.4
Oct-07	GE/2005/50 10-Year Extended LPM Project, Phase 5, Package E - LPM Works for Slopes in Tai Po	China Geo-Engineering Corporation	CM Wong & Associated Ltd	2001	630
Feb-08	CV/2006/05 Maintenance of Seawalls and Navigation Channels	China Harbor Engineering Co Ltd	Civil Engineering and Development Department	2001 2101 2101	3,375 9,318.4 7,650
Jun-08	Private project	Works of Diver Engineer Ltd		2001	675
Jun-08	DC/2007/10 Design and Construction of HK West Drainage Tunnel	Tapco Civil Engineering Co Ltd Dragages - Nishimatsu JV	Ove Arup & Partners HK Ltd	2001 2101	3,375 1,165
Jul-08	GE/2006/31 10-year Extended LPM project Phase 6, Package L, Landslip Preventive Works for Slopes in Western New Territories and Outlying Islands	Kwan On Construction Company Ltd		2001	675
Jul-08	HY/2006/02 Improvement of Roadside Slopes/ Retaining Walls on HK Island	Geotech Engineering Ltd	Ove Arup and Partners HK Ltd	2001	675
Jul-08	GE/2006/27 10-Year Extended LPM Project Phase 6, Package K Landslip Preventive Works for Slopes in Hong Kong Island (batch A)	Geotech Engineering Ltd	Civil Engineering and Development Department	2001	675
Jul-08	GE/2006/10 Landslide hazard mitigation works in On Yam, Shek Lei, Victoria Road Nad Luk Keng Wong Uk and field instrumentation works at four selected hillsides	Carrier Construction Ltd	Ove Arup and Partners HK Ltd	2001 2101	675 510
Oct-08	GE/2006/17 10 Year Extended Landslip Preventive Measures Project, Phase 4, Packages A, Landslip Preventive Works for Slopes in Tsuen Wan and Kwai Tsing (Batch B)	China Geo-Engineering Corporation	Mannings (Asia) Consultants Ltd	2101	582



Nov-08	DC/2007/06 River Improvement Works in Upper Lam Tsuen River, She Shan River and Upper Tai Po River	Kwan Lee Construction Co Ltd	Maunsell Consultants Asia Ltd	2101 2101	16,889.60 8160
Dec-08	North Point Pier	Friendly Benefit Eng Ltd		2101	582.4
Mar-08	CV/2007/03 Construction of site formation, roads, drains and upgrading of existing infrastructure between existing Anderson Road Quarry and Sau Mau Ping Road	China State Construction Engineering (HK) Ltd	Ove Arup and Partners HK Ltd	2101 2101	57,075.20 63750
Feb-09	GE/2008/21 10 Year Extended LPM Project, Phase 7, Package G Landslip Preventive Work for Catchwater Slopes in Sha Tin and Tsuen Wan- Batch B	China Geo-Engineering Corporation	Halcrow China Limited	2101	510.0
Apr-09	CHEC247 Lamma Power Station-Navigation Channel Improvement	China Harbour Engineering Co Ltd		2101	4,659.2
Aug-09	HY/2007/10 Reconstruction and Improvement of Tuen Mun Road - Tai Lam Section	Shun Tat Construction Engineering Ltd	AECOM Asia Company Ltd	2101 2101	582.4 3570
Sep-09	TKO Landfill Bad	Green Valley Landfill Ltd		2101	2550
Sep-09	DC/2006/11 Drainage Improvement in Southern Lantau and Construction of Mui Wo Village Sewerage Phase 1	Yick Hing Construction Co Ltd	Drainage Services Department	2101	13,770 1,747.20
Oct-09	ST/2008/02 Drainage and Sewerage Works at Whitehead and Lok Wo Sha Phase 1	China Road and Bridge Corp	AECOM Asia Company Ltd	2101	5,100
Jan-10	Royal HK Yacht Club	Tak Cheong Construction Co Ltd		2101	510
Jan-10	KL/2008/07 Kai Tak Development - Advance Infrastructure Works for Developments at the Southern Part of the Former Runway, Stage 1	Friendly Benefit Engineering Ltd	AECOM	2101 2101	15,300 12,812.80
Jan-10	TK/2009/01 Infrastructure Works at Town Centre South and Tiu Keng Leng, Tseung Kwan	Shun Tat Construction Engineering Ltd	Meinhardt (C&S) Ltd	2101	1,020
Feb-10	HY/2008/09 Widening of Tolo Highway / Fanling Highway Between Island House and Fanling	China State Construction Engineering (HK) Ltd	Hyder-Arup-Black and Veatch JV	2101	4,080
Mar-10	DC/2008/06 Drainage Improvements in Southern HK Island - Package 1	Kuly Construction & Eng Co Ltd	DSD	2101	510
Mar-10	North Point Reclamation	UDL-Ship Management Ltd	AECOM Asia	2101	510
Mar-10	Hong Kong University	China State Construction Eng (HK) Ltd		2101 2101	6,120 9,318.40
Apr-10	KL/2009/01 Site Formation for Kai Tak Cruise Terminal Development	Kwan Sing Construction Ltd	Scott Wilson (HK) Ltd	2101 2101	8,160 6,406.40
Apr-10	HY/2009/11 Central Wanchai Bypass - North Point Reclamation	China Harbour Engineering Co Ltd	AECOM Asia	2101 2101	8,160 1,164.80
Jun-10	9/WSD/08 Laying of Western Cross Harbour Main and Associated Land Main Form West kowloon to Sai Ying Pun	Shun Tat Construction Engineering Ltd	Mott Connell Ltd	2101	2,329.60



Aug-10	HK/2009/01 Wan Chai Development Phase II Central Wanchai Bypass	Shun Tat Construction Engineering Ltd	AECOM Asia	2101	1,164.80
Jul-10	Proposed residential developments on TPTL 186 Pak Shek Kok, Tai Po	Tysan Foundation Ltd		2101	1,164.80
Oct-10	DC/2007/12 Design and Construction of Tsuen Wan Drainage Tunnel	Shun Tat Construction Eng Ltd	Hyder Consulting Ltd	2101	2,040.00
May-10	HK/2009/02 Wan Chai Development Phase II	Chun Wo-CRGL Joint Venture Tung Wo Eng Co Ltd	AECOM Asia	2101 2101	1,020.00 510.00
Nov-10	DC/2008/03 Sludge Treatment Facilities	China State Construction Eng (HK) Ltd		2101	1,020.00
Nov-10	CV/2010/03	China Harbour Eng Co Ltd		2101	510.00



Woven Geotextile
Kimdatex CEF2101

Approval Letters

發件人: G.E.L. 收件者: Mr. Stanley Wan / Ms. Tsui

日期: 5/8/2008 時間: 11:36:12

第1頁(共1頁)

C M WONG & ASSOCIATES LTD
Consulting Engineers

1104 UNIVERSAL TRADE CENTRE, 3-5A ARBUTHNOT ROAD, HONG KONG
TEL: (852) 2528 1068 Web-site: <http://www.cmwal.com>
FAX: (852) 2528 3111 E-mail: cmwal@cmwal.com

YOUR REF

OUR REF LPM/GE/2006/27/R20/720/RE824

31 July 2008

Geotech Engineering Limited
Room 2207,
22/F, CCT Telecom Building,
11 Wo Shing Street,
Fotan, N. T.

Attn: Mr. Tang Yiu-Pong

Dear Sir,

Contract No. GE/2006/27
10-Year Extended LPM Project, Phase 6, Package K-
Landslip Prevention Works for Slopes in Hong Kong Island (Batch A)
Material Submission - Woven Geotextile Yihua Bonar GEF2001

We refer to your letter ref. 0627/Mat/024 dated 18 July 2007 regarding the captioned subject.

We have no objection in principle to the captioned alternative material supplied by G and E Company Limited for our approved material "Mirafi 500XL Woven Geotextile". The captioned geotextile shall be installed for raking drain connections on soil slope with erosion control mat on trial basis until "Mirafi 500XL Woven Geotextile" is available in the market.

You are reminded that the handling, application and storage of the materials shall be in strict accordance with the contract requirement and the manufacturer's recommendations.

Please submit for each batch of geotextile delivered to the Site as required by G.S. Clause 7.157.

Yours faithfully,
For and on behalf of
C M WONG & ASSOCIATES LTD

Paul Au
Engineer's Representative

c.c. Head Office (Attn.: Mr. Chris Lee)

PA/CSJew

Rec. Date: *08/08*

Contract No. 06/2006/27	
File	Sign Copy
EM	
Site Agent	
Site Eng.	
Cl. Foreman	
Foreman	
Sub-Contract	
Site	

黃志明
總工程師
有限公司

TO BE COLLECTED

黃志明 Mr. C M WONG (P. Eng) 1945年10月10日 香港 註冊工程師 (專業) (CPE)
 劉偉強 Mr. BEN WY TSE (S. Eng) 1942年10月10日 香港 註冊工程師 (專業) (CPE)
 李丁強 Mr. CHRISTOPHER LEE (S. Eng) 1942年10月10日 香港 註冊工程師 (專業) (CPE)
 楊志強 Mr. ALEXIS YEUNG (S. Eng) 1942年10月10日 香港 註冊工程師 (專業) (CPE)
 梁志強 Mr. BEN CHUNG (S. Eng) 1942年10月10日 香港 註冊工程師 (專業) (CPE)
 李振強 Mr. JASON SIMPSON (S. Eng) 1942年10月10日 香港 註冊工程師 (專業) (CPE)



寄件者 : G.E.L. 收件者 : Mr. Stanley Wan / Ms. Tsui

日期 : 15/7/2008 時間 : 15:22:08

第 1 頁 (共 1 頁)

Ove Arup & Partners
奧雅遜工程顧問

Your ref HY0602/Manual/031
Site ref ARUP/HYD/(HY/2006/02)/R20/770/0934
Our ref 24506/GEO/07-01-01
Date 10 July 2008

Engineer's Principal Site Office
Floor 6, Flat F, Yan's Tower
Wong Chuk Hang Road
Hong Kong
Tel +852 3188 9740
Fax +852 3188 9746

www.arup.com

BY HAND

Geotech Engineering Limited
Room 2207, 22/F, CCT Telecom Bldg.,
11 Wo Shing Street, Fotan, N.T.
Hong Kong S.A.R.

For the attention of Mr. Franky Chan

Dear Sir

Agreement No. CES2/2004(GE)
Upgrading/Improvement of Roadside Slopes/ Retaining Walls
on Hong Kong Island (2005 to 2008 Programme)
Investigation, Design and Construction
Contract No. HY/2006/02
Material Submission - Woven Geotextile

I refer to the above letter reference dated 27 June 2008 regarding the captioned for the Contract.

I have no objection in principle to your proposal of using "Yihua Bonar CEF2001" manufactured by G & E Engineering Co. Ltd as the woven geotextile under the captioned Contract.

You are required to ensure that the application is strictly complied with manufacturer's recommendation and the Contract requirement. Should you have any queries, please contact the undersigned.

Yours faithfully



Eric Chan
Engineer's Representative

cc Works/ Hyd- Mr. K.C. Wong/ Ms. Shirley Chiu
Arup - Mr. Albert Ho

(Fax : 3188 3418)
(Fax : 2268 3970)

ARUP

Scott Wilson Ltd
保信顧問集團有限公司



DSD CONTRACT No. DC/2005/10
DRAINAGE IMPROVEMENT WORKS AT YUNG SHUE LONG NEW VILLAGE IN
LAMHA ISLAND, TSING LAN SHUE IN SAI KUNG AND SHUI LAU HANG IN TAK
KWU LING

Engineer's Representative
for the Contract

34/F, Metropia Tower 1
New Hong KONG
of Resident Engineer's Office
Yick Yuen
Tuen Mun

YOUR REF : DC20050-376

MYREF : DC2005/10/R20/120(6)

Phone : (852) 2944 2811
Fax : (852) 2944 2844
Email : rps.dsd@scottwilson.com.hk

DATE : 11 August 2006

Kwan On Construction Co. Ltd.
3E, Yiko Industrial Building
10, Ka Yip Street
Chai Wan
Hong Kong

By Fax & Mail

Attn: Mr. Ricky Ko

Dear Sir

Material Substitution - Woven Geotextile

Reference is made to your letter dated 5 August 2006 proposing the use of "CEB 2001 Woven geotextile" supplied by G&E Co. Ltd.

I have no objection to your proposal to use "CEB 2001 woven geotextile material" for this Contract.

Yours faithfully

(Simon Leung)
Engineer's Representative

SL/el

cc: SW - Mr. Oliver Au-yung

Date Recd:	14 AUG 2006
Project Name	DC2005/10
Drawn	
Checked	
Approved	
Reviewed	
By	
For	
Signature	

2005/10

10 = PAGE 25:01 61-80-8661
20' H 7101

土木工程處
Civil Engineering Office



土木工程署
Civil Engineering
Department

Telephone (852) 762 5543
Facsimile (852) 714 0113
Our reference (54) in PWO CV/90/06 PT.3
Your reference CHEC 20/173/080

21 January 1993

China Harbour Engineering Company
19/F, China Harbour Building,
370-374, King's Road,
North Point, Hong Kong.
(Attn. : Mr. HUI Kwok-sun)

Dear Sirs,

Contract No. CV/90/06
Construction of Aldrich Bay Typhoon Shelter Reclamation.
Geotextile : Propex 2001

I refer to your above quoted letter and wish to confirm that Propex 2001 is approved to be used as geotextile in this contract subject to satisfactory performance on site.

DATE	24 FEB 1993			
FILE	CHEC 20/173			
NAME	ACTN	ENR.	INITIAL	OFF
SITE AGENT				
SUB-AGENT				
ENGINEER				
Q. SURVEYOR				
SURVEYOR				

Yours faithfully,

(YUNG Chung-bun)
Engineer's Representative
Port Works Division
Civil Engineering Department

CBY/

c.c. S10W/I4
Site Agent thro' S10W/I4
Site Office

31-AUG-01 11:20

FL23/99 (GWCH)

+852 2344 7559

P.01

To: Staley

RECEIVED 06 DEC 1999

Re: for your record

COPIES

MAUNSELL CONSULTANTS ASIA LTD

茂盛(亞洲)工程顧問有限公司

8/F. GRAND CENTRAL PLAZA, TOWER 2
138 SHATIN RURAL COMMITTEE ROAD
SHATIN, N.T., HONG KONG

香港新界沙田圍新會路138號
新城市中央廣場第2座8樓

PLEASE REPLY TO:
CENTRAL SITE OFFICE,
TING KOK ROAD, YUE KOK,
TAI'PO, N.T.

Tel.: 2664 5145
Fax: 2668 8812

Resident Engineer's Site Office
(Group MDCII)

Tel.: 672 3497

Fax: 671 0319

E-mail: mdc2@newigator.com

Attn: Mr. Gary Ng

FAX: 2570 0089

Tim Kaban

3/08/01

RECEIVED
4 JUL 2000

TEL (852) 2805 6262
FAX (852) 2891 2849

Maunsell

Our Ref: NTN(FL/23/99)C21 050/10(0002)

3 December, 1999

The Site Agent,
Guangdong Water Conservancy &
Hydro-Power Engineering Development Co., Ltd.,
22/F., Guangdong Water Building,
83 Austin Road,
Tsim Sha Tsui,
Kowloon.

Attn: Mr. YIU Ming-sum, Sam

Dear Sir,

T.D.D. Contract No. FL 23/99
Main Drainage Channels for Farling, Sheung Shui and Hinterland -
River Training Works for Upper River Indus
Proposed Geotextile Type 2

I refer to the details of your proposed geotextile type 2, Propex 2001, handed by you to my
ARE Mr. C. Chan on 2 December 1999.

Relying on the information contained in your submitted details, I have no objection to your
proposed Propex 2001 for the geotextile type 2 for this Contract.

Yours faithfully,

LEUNG Kin-on Dennis
Resident Engineer

KPC/kpc

cc MCAL (Attn: Mr. Francis LEONG)
CSO
IOW

FL23梧桐河地盤

Rec'd	File No.
	A 425
Action	Info
PM	
Asst.	
Eng.	
C.S.	
Survey	
Foreman	

Handwritten notes and dates: 31/5/01, 2/9/01, 5/9/01, etc.

FROM : CCRIBJV TK45/2000

PHONE NO. : + 852 2623 6016

SEP. 26 2000 04:47PM P

MAUNSELL CONSULTANTS ASIA LTD
茂威(亞洲)工程顧問有限公司

8/F, GRAND CENTRAL PLAZA, TOWER 2
138 SHATIN RURAL COMMITTEE ROAD
SHATIN, N.T., HONG KONG
香港新界沙田鄉事會路138號
中區中區廣場第2座8樓

TEL (852) 2605 6262
FAX (852) 2691 2849

Maunsell

Chief Resident Engineer's Office
Po Lam Road
Tseung Kwan O

Tel. No. : 2701 0811
Fax No. : 2701 8155

Your Ref. :
Our Ref. : TKO/(TK45/00)/C20/510(5)

17th July 2000

China Civil, Road & Bridge Joint Venture
23/F, Railway Plaza
39 Chatham Road South
Tsimshatsui
Kowloon

Int. Circulation			
GM		DMD	
CM	<i>Propex</i>	DGM	
PM		CQS	
S/S			

Dear Sirs,

Tseung Kwan O Development Phase 3
Contract No. TK45/2000
Remaining Reclamation in the Town Centre Extension, Stage 2
and Associated Main Drainage Works
Submission of Material - Geotextile Filter Type 2 and 3

I refer to my recent letter ref. TKO/(TK45/00)/C20/510(3) dated 11.7.2000 and our subsequent discussion (Tso/Tung/Garcia/Pisano) dated 14.7.2000 regarding the above captioned.

The proposed material "Propex 2001" supplied by G & E Company Ltd is found to comply with the Specification for Geotextile Type 2 and is therefore acceptable as Geotextile Type 2.

Regarding the acceptability of the above same material as Geotextile Type 3, you are reminded to submit the outstanding information as per my letter of 11.7.2000.

Yours faithfully,

Ringo W K Tso
Resident Engineer

RECEIVED
18 JUL 2000

cc MCAL
CRB
M/F

BY: *[Signature]*

RT/LBG/ft

*please go ahead and
place order as per
cartload and 6q*

[Signature]
21-7-00



Our Ref. : WKP/cl/6215/S0019/4.0(b)

Date : 3rd September 2002

Bilfinger Berger AG
 Hong Kong Branch
 Rm. 1503, 15/F., Stanhope H
 734-738 King's Road
 Hong Kong
 Phone: (+852) 2794 6688
 Fax: (+852) 2337 1232

The Resident Engineer
 Maunsell Consultants Asia Ltd
 Central Site Office
 Ting Kok Road, Yue Kok
 Tai Po
 N.T.

Attn. : Mr. W. K. Luk

Dear Sir,

TDD Contract No. FL27/02
Completion of the Remaining River Training Works
for Upper River Indus between Man Kam To Road and San Wai
Geotextile Type 2

Pursuant to PS Clause 7.150(5) and GS Clause 7.157(1), we herewith propose the use of "Propex 2001" manufactured by Messrs. Yihua Polytiles Company Limited and supplied by Messrs. G and E Company Limited as Geotextile Type 2 in the captioned Contract. Attached herewith are the technical literatures of the material with past job references and approval letters from previous applications for your perusal and approval.

Yours faithfully
 For and on behalf of
Bilfinger Berger AG

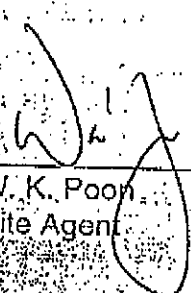

 W. K. Poon
 Site Agent

Encl.

c.c. MCAL
CSO

FROM : CCRBJV TK45/2000

PHONE NO. : + 852 2623 6016

SEP. 26 2000 04:46PM P.

MAUNSELL CONSULTANTS ASIA LTD
茂盛(亞洲)工程顧問有限公司

8/F, GRAND CENTRAL PLAZA, TOWER 2
138 SHATIN RURAL COMMITTEE ROAD
SHATIN, N.T., HONG KONG
香港新界沙田新街138號
新城市中央廣場第2座8樓

TEL (852) 2605 6262
FAX (852) 2691 2649

Maunsell

Chief Resident Engineer's Office
Po Lam Road
Tseung Kwan O

Tel. No. : 2701 0811
Fax No. : 2701 3155

Your Ref. : C146/H.T509/P6.2.2
Our Ref. : TKO/(TK45/00)/C20/510(10)

25th August 2000

China Civil, Road & Bridge Joint Venture
23/F, Railway Plaza
39 Chatham Road South
Tsimshatsui
Kowloon

RECEIVED
25 AUG 2000

BY:.....

Dear Sirs,

Tseung Kwan O Development Phase 3
Contract No. TK45/2000
Remaining Reclamation in the Town Centre Extension, Stage 2
and Associated Main Drainage Works
Submission (Material) - Geotextile Filter Type 3 "Propex 2001"

Further to your letter ref. C146/H.T509/P6.2.2 dated 1.8.2000, I write to confirm that the proposed material "Propex 2001" as supplied by G & E Company Ltd is acceptable as Geotextile Type 3 for this Contract.

Yours faithfully,

Ringo W K Tso
Resident Engineer

cc MCAL
CRE
M/F

RT/R
Silvia,
pass copy to BR
and return this
original to
circulation.

2-9-00

File No.	Info	Action	Copy
PM	✓		
SA	✓	✓	
Sub-Agent	✓		
Eng.	✓		
Q.S.	✓		
Surveyor	✓		
G.R.	✓		
S.O.			
Others			

Copy to Phillip Rich ✓
P.L.C.



Maunsell Consultants Asia Ltd
茂盛(亞洲)工程顧問有限公司

Maunsell

PRINCIPAL RESIDENT ENGINEER'S OFFICE
Cheung Tung Road
Yam O
Lantau Island

Tel. : 2643 9020
Fax : 2643 1559

8/F., Grand Central Plaza, Tower 2
138 Shear Water Corporate Road
She Tin, N.T., Hong Kong
香港新田區翠濠庭大廈 8樓
新田區翠濠庭大廈 8樓

Tel (852) 2605 6262
Fax (852) 2691 2649
www.maunsell.com.hk

8 November, 2001

Your Ref : CV/2000/09/CMS/100005/A

Our Ref : (CV/2000/09)/R20/820(1)

The Agent
China State Construction Engineering Corporation
29/F China Overseas Building
139 Hennessy Road
Wanchai
Hong Kong

Attn : Mr. W.S. Chong

Dear Sir,

CED Contract No. CV/2000/09
Infrastructure for Penny's Bay Development - Contract 1
Geotextile Propex Style 2001 Type 2 for Western Drainage Channel

I refer to your material submission dated 30 October 2001 and confirm that the proposed geotextile "Proper Style 2001" supplied by Yizheng Amoco Fabrics Company Limited is acceptable for use in this project.

Please be reminded that certificates should be submitted for each batch of geotextile delivered to the site as required by G.S. Clause 7.157.

Yours faithfully,

Henry Chan
Chief Resident Engineer

cc : MCAL - Keith Tsang

HC/PL/HY/wch
PRE/023

DIRECTOR: YIP KWONG
TECHNICAL DIRECTORS: JERUM, SA ROBINSON, KY WONG, FRANK WONG, SHUN WAI, DSI, SHI SHI, HONG, NI QIAN
ASSOCIATE DIRECTORS: FRYN, YAN, ASHROCK, P. CHONG, C. CHONG, AZIMAH, W. H. CHAN, CH. T. CHANG, Y. LING, COWLING, TSANG
OFFICES: AUSTRALIA, CHINA, HONG KONG, IRELAND, JAPAN, LIBERIA, MALAYSIA, MALTA, THE PHILIPPINES, QATAR, SINGAPORE, THAILAND, UNITED ARAB EMIRATES, UNITED KINGDOM, USA

AN ASCOM COMPANY



ISO 9001:1994
Certificate No. 00054

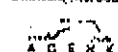

RECEIVED 23 JAN 2003

ARUP

Level 5, Festival Walk
80 Tat Chee Avenue
Kowloon Tong, Kowloon
Hong Kong
www.arup.com

FAX IN
28 JAN 2003

Tel +852 2528 3031
Fax +852 2268 3947
Direct Tel +852 2268 3171

To DML - Mr Andy Cheung 3550-3440

Date
27 January 2003

Copies RLP - Mr Patrick Chui

Job No/Ref
23398/TL/IL/023

From Teresa Lee

File Ref 15.20

Subject Hong Kong Disneyland Hotel

Page 1 of 1

The information contained in this fax message is confidential and intended only for the addressee(s).
If you are not an intended recipient please notify us and destroy this document. Thank you.

Contractor's Submissions

We refer to the following GSL's submissions:-

Item	Submission Date	GSL's reference	DML's Reference
FOSROC Supercast SW Hydrophilic Strip	13 January 2003	J2892/304.5/ D0070	WDIHK/SP-1a/AC/ea/ 2003-000376
Geotextile CEF2001	15 January 2003	J2892/304.5/ D0068	WDIHK/SP-1a/AC/ea/ 2003-000375

Please note that we have no adverse comment.

Regards

Teresa Lee

AECOM

8/F Grand Central Plaza, Tower 2, 138 Shatin Rural Committee Road, Shatin, N.T., Hong Kong
 香港新界沙田鄉事會路 138 號新城市中央廣場第 2 座 8 樓
 T +852 2605 6262 F +852 2691 2649 www.aecom.com
 (Formerly known as Maunsell AECOM / ENSR AECOM)

Your Ref : (out)CRBC/ST200802/S210(4)/033
 Our Ref : NTE(ST/2008/02)/C25/350(0002)

China Road and Bridge Corporation
 Units 1805-10
 18/F K Wah Centre
 191 Java Road
 North Point
 Hong Kong

CRE's Office, Road T3 (Shatin),
 15 Mei Tin Road, Tai Wai, Sha Tin, N.T.
 香港新界沙田大圍美田路15號
 T +852 2687 0838
 F +852 2687 2322
 E co@t3-maunsell.com.hk

(Attn: Mr. Raymond S.W. Mau)

22 September 2009

Dear Sirs,

Ma On Shan Development
Contract No. ST/2008/02
Roads, Drainage and Sewerage Works at Whitehead and Lok Wo Sha Phase 1

Geotextile Type 2 for Box Culvert

I refer to your letter referenced above dated 16 September 2009 proposing Kimdatex CEF2101 supplied by G and E Company Limited to be used as geotextile type 2 for the construction of box culvert in this Contract.

Please be advised that your proposed geotextile type 2 is accepted in principle provided that the handling, storage and use of the proposed material should be strictly in compliance with the Contract's requirement and the manufacturer's recommendations.

Yours faithfully,

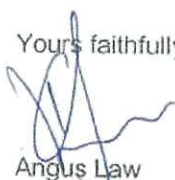

Angus Law
 Resident Engineer
 AECOM Asia Co. Ltd.
 (Formerly known as Maunsell Consultants Asia Limited)

DK/ALJH/mk



cc AACL - Attn : Mr. Francis Leong

RECEIVED
 25 SEP 2009

BY:

LETTER IN
 No. 0212

Important Message

Rebranding as AECOM

To better serve our clients, all Maunsell AECOM operations in Hong Kong have been integrated into one operating entity and rebranded as AECOM. The Maunsell Consultants Asia Ltd. operation is now part of AECOM Asia Co. Ltd.



Woven Geotextile
Kimdatex CEF2101

Photo References



G AND E COMPANY LIMITED

14/F, Kiu Yin Building Commercial,
361 - 363 Lockhart Road,
Wanchai, Hong Kong
Tel: 852-2570 0103 Fax: 852-2570 0089
website: www.g-and-e.com

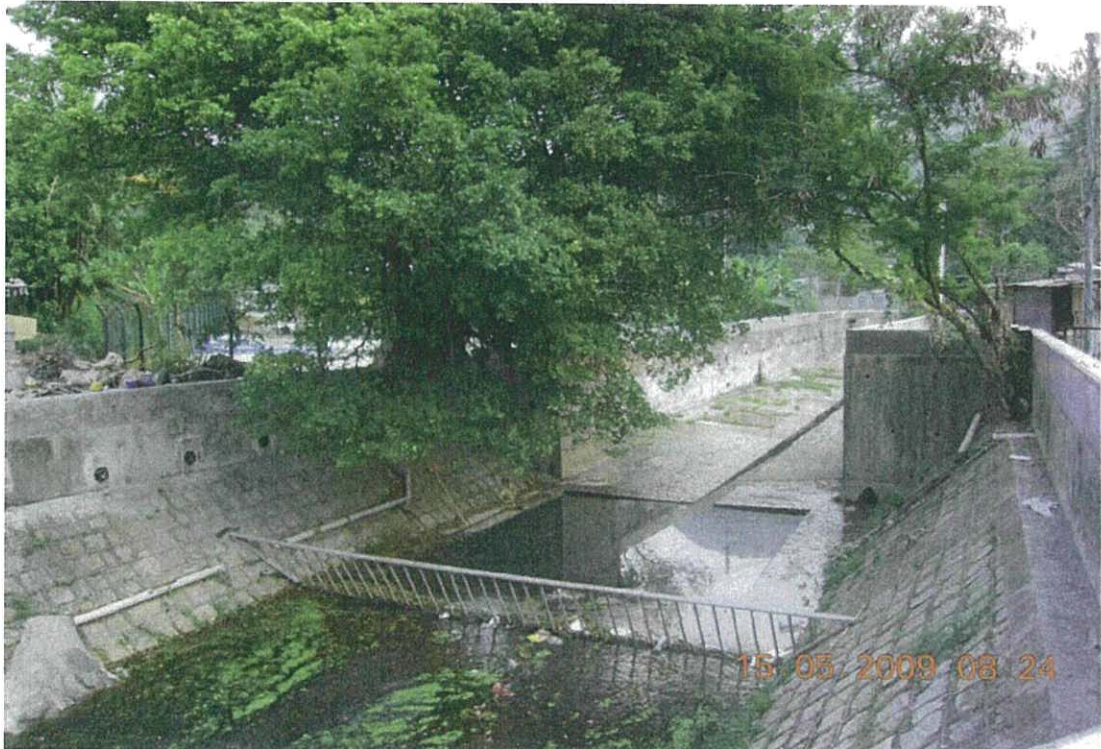

Date	March 2010
Project	Contract No. DC/2008/06 Drainage Improvements in Southern HK Island - Package 1
Client	DSD
Consultant	DSD
Main Contractor	Kuly Construction & Eng Co Ltd
Material	CEF 2101
Size	510 sq m



G AND E COMPANY LIMITED

14/F Kiu Yin Commercial Building
361 - 363 Lockhart Road,
Wanchai, Hong Kong
Tel: 852-2570 0103 Fax: 852-2570 0089
website: www.g-and-e.com



Date	January 2010
Project	KL/2008/07 Kai Tak Development-Infrastructure works at Southern part of former runway, Stage 1
Client	CEDD
Consultant	AECOM
Main Contractor	Friendly benefit Engineering Ltd
Materials	CEF2101
Size	11,220 sqm



G AND E COMPANY LIMITED

14/F Kiu Yin Commercial Building

361 - 363 Lockhart Road,

Wanchai, Hong Kong

Tel: 852-2570 0103 Fax: 852-2570 0089

website: www.g-and-e.com



Date	Jan 2004
Project	HY/2003/01 Route 9 - Lai Chi Lok Viaduct Package of Realigned Channel at Wai Man Tsuen
Client	Highways Department
Consultant	Maunsell Hyder Joint Venture
Main Contractor	Necso Entrecanales Cubiertas, SA
Materials	CEF2001
Size	18,134 sqm



G AND E COMPANY LIMITED

14/F Kiu Yin Commercial Building
361 - 363 Lockhart Road,
Wanchai, Hong Kong
Tel: 852-2570 0103 Fax: 852-2570 0089
website: www.g-and-e.com



Date	October 2002
Project	Contract No. CV/2001/10 Infrastructure for Penny's Bay Development - Contract 2, the Decommissioning of Cheoy Lee Shipyard
Client	Civil Engineering Department
Consultant	ENSR Asia (HK) Ltd
Main Contractor	China State Construction Engrg. Corp
Works	Soil Cover
Material	CEF2001
Size	75,760 sqm



G AND E COMPANY LIMITED

14th Floor, Kiu Yin Commercial Building
361-363 Lockhart Road
Wanchai, Hong Kong
Tel: 852-2570 0103 Fax: 852-2570 0089
website: www.g-and-e.com

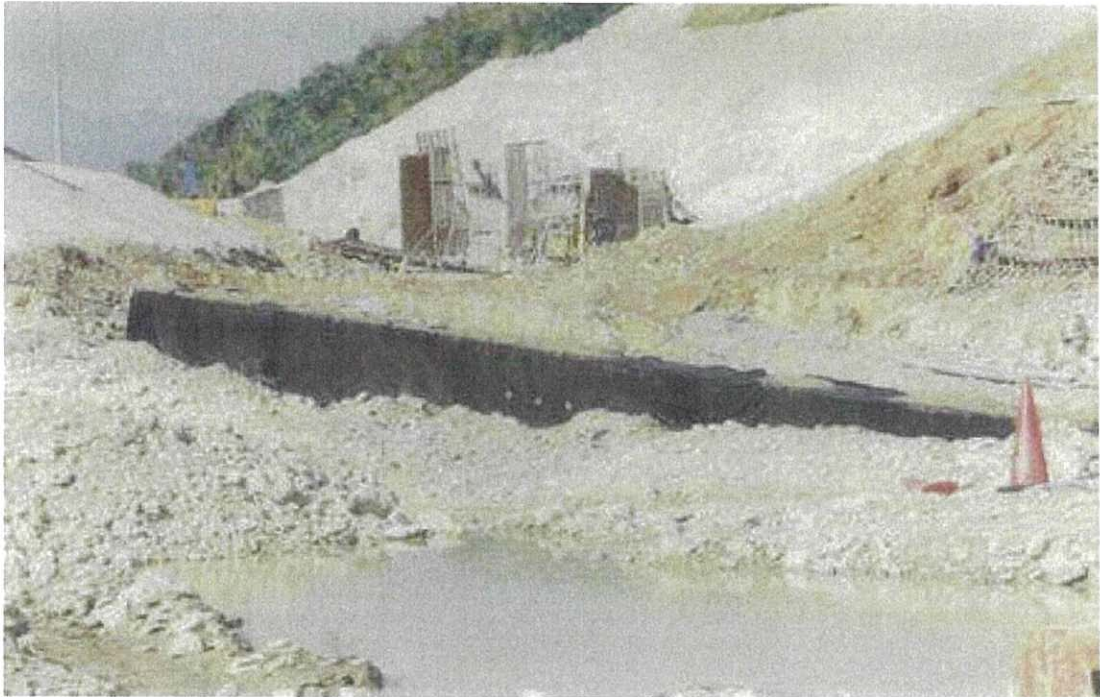

Date	April 2002
Project	Contract No. CV/2000/09 Infrastructure for Penny's Bay Development - Contract I
Client	Civil Engineering Department
Consultant	Maunsell Consultants Asia Ltd
Main Contractor	China State Construction Engrg. (Hong Kong) Ltd
Works	Separation at retaining wall
Material	CEF2001
Size	656,273 sqm



G AND E COMPANY LIMITED

14/F., Kiu Yin Commercial Building,
361 - 363 Lockhart Road,
Wanchai, Hong Kong
Tel: 852-2570 0103 Fax: 852-2570 0089
website: www.g-and-e.com

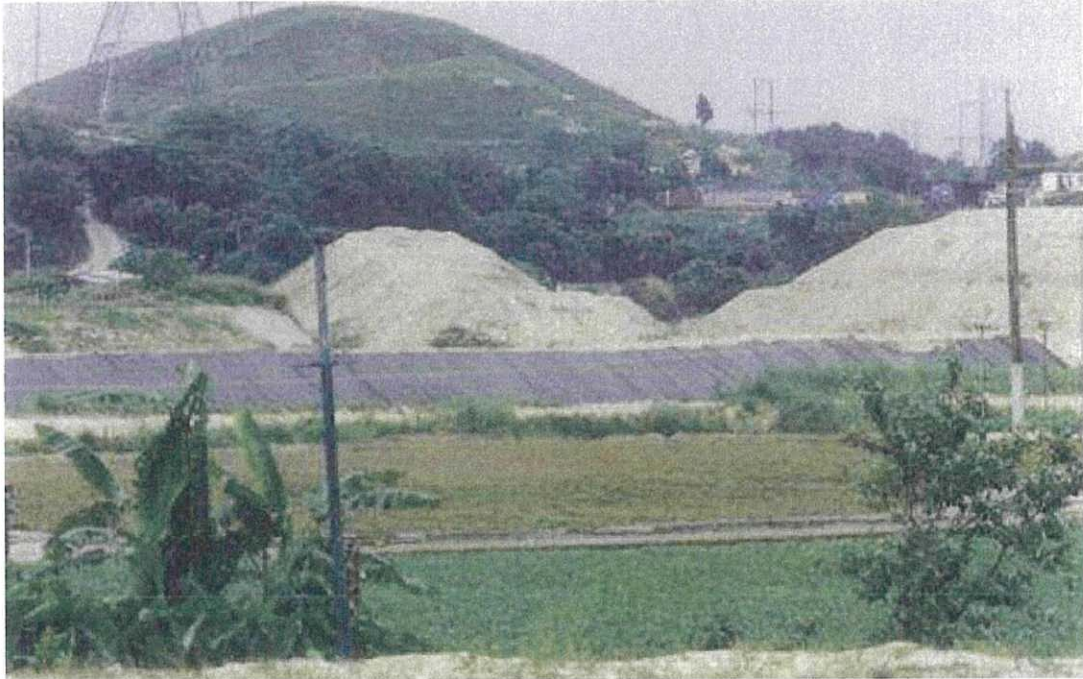

Date	December, 1999
Project	Contract No. FL/23/99 Main Drainage Channels for Fanling, Sheung Shui and Hinterland
Client	Drainage Services Department
Consultant	Maunsell Consultant Asia Ltd
Main Contractor	Guangshing Civil Eng. Co Ltd
Material	CEF2001
Works	Embankment Soil Separation
Size	200,000 sqm



G AND E COMPANY LIMITED

14th Floor, Kiu Yin Commercial Building

361-363 Lockhart Road

Wanchai, Hong Kong

Tel: 852-2570 0103 Fax: 852-2570 0089

website: www.g-and-e.com



Date	Jan 1993
Project	Contract No CV/90/06 Aldrich Bay Typhoon Shelter Reclamation
Client	Civil Engineering Department
Consultant	Civil Engineering Department
Main Contractor	China Harbour Engineering Company
Material	Woven CEF 2001
Size	245,679 sqm



Woven Geotextile
Kimdatex CEF2101

About the Supplier - G and E Co. Ltd



G AND E COMPANY LIMITED

14/F Kiu Yin Commercial Building
361 – 363 Lockhart Road,
Wanchai, Hong Kong
Tel: 2570 0103 Fax: 2570 0089

website: www.g-and-e.com

G and E Company – a Perspective

G and E, founded in 1984, is a geosynthetics specialist who distributes a wide variety of geosynthetics from a global list of renowned manufacturers. The Company also manages a competent installation contracting service. To better serve our clients, design and engineering service have also been established in our portfolio. It is our goal that we can provide comprehensive engineering solutions to our clients, from technical application and design, the supply of materials and their installation, as well as the conformance testing and system commissioning.

G and E takes a strong vision on geosynthetics application and development by working closely with international consultants, academics, professional organizations, research institutions and worldwide manufacturers in the industry, a mission to broaden the versatility of geosynthetics and its innovation.



Our product range covers:

Geotextile, geomembrane, geodrain, geogrid, geoblock, band drain, erosion control synthetic, Geosynthetic clay liner, rockfall barrier, gabion HDPE geopipe with extended application in waterproofing and environmental control as well as silt curtain, and geotextile container fabrication.

We offer our clients:

- Extensive product experience
- Comprehensive services, application, design, installation and commissioning
- Highly attentive and superior professional work
- High quality products
- Flexible & competent management



Recognized as a member of the International Association of Geosynthetic Installers and a VSRS registered subcontractor, G and E had maintained a remarkable successful working relationship with a long list of clients, the Government, project owners, contractors, designers, consultant engineers, overseas distributors and traders. The client base extends to Macau, Southeast Asia and Southern China.

Talk to us today and see how we can work together for cost-effective and time saving solutions. We are stepping into the 27th year in the field and have vast experience to share with you.

A member of



Product Endorsement



A Registered Subcontractor





THE GEOSYNTHETICS SPECIALIST

G and E is a distribution network and sourcing agent of geosynthetics as well as a provider of professional design and installation services.



Inspiration Lake with HDPE geomembrane waterproofing system, Disneyland Hong Kong, 2005

The company handles a comprehensive range of geosynthetic materials:

<u>GEOTEXTILE:</u>	Woven, non woven, thermal bonded, needle punched
<u>GEOMEMBRANE:</u>	Sheet membrane, keyed preformed, tunnel lining, concrete protection liner, gas barrier, basement waterproofing, leakage collection & fluid containment, root barrier
<u>GEODRAIN:</u>	Geonet, geocomposite, band drain, sheet drain, dimple drain
<u>GEOGRID:</u>	Soil stabilization, wrap back slope, MSEW, reinforced panel system, rockfall bund, paving reinforcement
<u>EROSION CONTROL:</u>	Erosion mat, concrete mat, coir mat, geocell, reno-mattress, gabion, rockfall mesh, flexible fence, rockfall barrier
<u>MARINE ENGINEERING:</u>	Silt curtain, mammal sound attenuation, turbidity control, trash boom, concrete former, geotextile container
<u>GCL:</u>	Geosynthetic Clay liner, bentonite liner
<u>HDPE PIPE:</u>	Sewer pipe, Spirolite, submarine outfall
<u>OTHERS:</u>	Steel fiber, polypropylene fiber
<u>SPECIAL SERVICE:</u>	Geomembrane leak location survey

GAND E COMPANY LIMITED

14th Floor, Kiu Yin Commercial Building, 361-363 Lockhart Road, Wanchai, Hong Kong
Tel: 2570 0103 Fax: 2570 0089 e-mail: wing@g-and-e.com website: www.g-and-e.com

Sep 2011

Typical Drawing

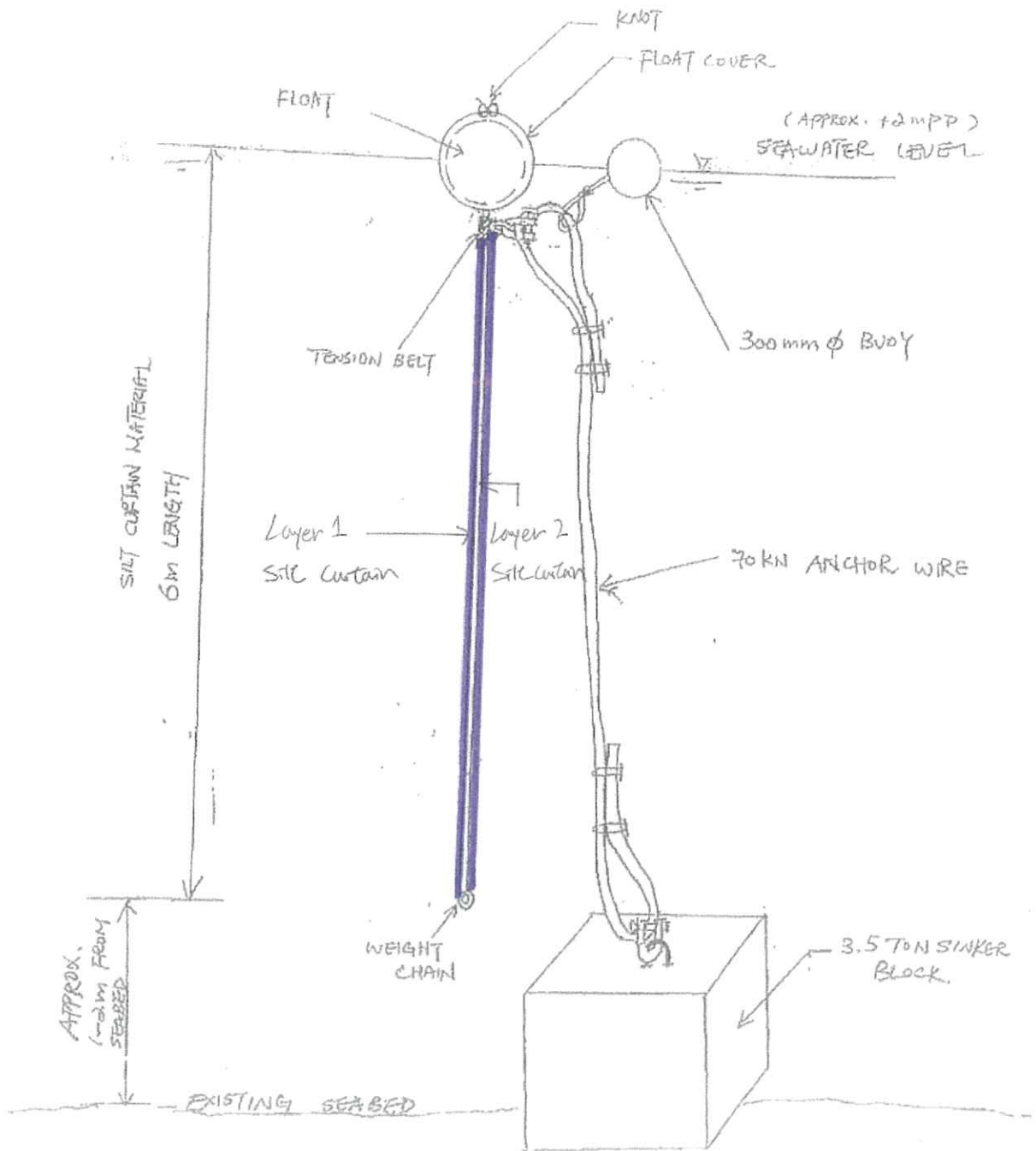

Section View of Double-layer Silt Curtain Installation Details



俊和 - 中國中鐵聯營

CHUN WO - CRGL JOINT VENTURE

Contract No. HK/2009/02

Wan Chai Development Phase II

Central - Wan Chai Bypass at Wan Chai East

Silt Screen Deployment Plan

Appendix J

Photo Records of Pumping Stations



俊和 - 中國中鐵聯營
CHUN WO - CRGL JOINT VENTURE

Contract No. HK/2009/02
Wan Chai Development Phase II
Central - Wan Chai Bypass at Wan Chai East
Silt Screen Deployment Plan

Location of
Irregular Shape

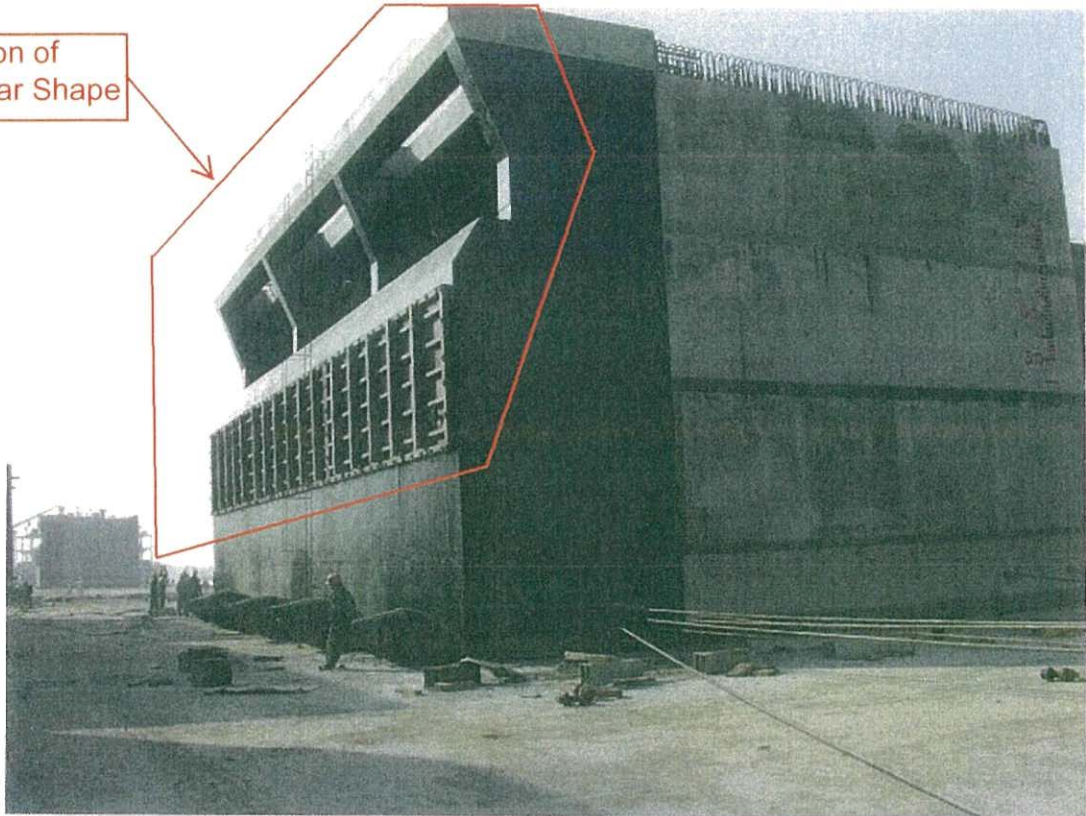

Photo record of SHK Centre Pumping Station (Great Eagle centre/ Harbour Centre Pumping Station, China Resources Building Pumping Station similar)



Lam Geotechnics Limited

Ground Investigation & Instrumentation Professionals

華益土力有限公司

Ref : G1120/CS/L428/FEP-03/356/2009
Date : 25 April 2013

Chun Wo – CRGL Joint Venture
24/F, Overseas Trust Bank Building,
160 Gloucester Road,
Wan Chai,
Hong Kong

Attn: Mr. David Lau, Deputy Project Manager

Dear Sir,

Contract No. HK/2009/02
Wanchai Development Phase II – Central –Wan Chai Bypass at Wan Chai East
Silt Screen Deployment Plan (Rev. E)

Referring to the captioned submission dated 3 April 2013 received through email on 3 April 2013, we have reviewed your submitted details and hereby certified this submission in accordance with Condition 2.9 of FEP-03/356/2009.

Should you have any enquiry, please feel free to contact the undersigned at 2839 5666.

Yours faithfully,

Raymond Dai
Environmental Team Leader

C.C.

CEDD	- Mr. Patrick Keung	(By Fax: 2577 5040)
AECOM	- Mr. Frankie Fan	(By Fax: 2587 1877)
ENVIRON	- Mr. David Yeung	(By Fax: 3548 6988)





Ref.: AACWBIECEM00_0_3856L.13

25 April 2013

Chun Wo – CRGL Joint Venture
24/F
Overseas Trust Bank Building
160 Gloucester Road
Wan Chai
Hong Kong

By Post and E-mail

Attention: Mr. David Lau (Deputy Project Manager)

Dear Sir,

Re: FEP-03/356/2009
Contract No. HK/2009/02
Wan Chai Development Phase II – Central-Wan Chai Bypass at Wan Chai East
Silt Screen Deployment Plan (Rev. E)

Reference is made to Chun Wo – CRGL Joint Venture's submission of Silt Screen Deployment Plan (Rev. E dated 3 April 2013) received through E-mail for our review and comment.

Please be informed that we have no adverse comment on the captioned submission. We write to verify the captioned submission in accordance with Condition 2.9 of FEP-03/356/2009.

Thank you for your kind attention.

Yours sincerely,

David Yeung
Independent Environmental Checker

c.c. CEDD
AECOM
AECOM
LAM

Mr. Patrick Keung
Mr. Frankie Fan
Mr. Conrad Ng
Mr. Raymond Dai

by fax: 2577 5040
by fax: 2587 1877
by fax: 2691 2649
by fax: 2882 3331

Q:\Projects\AACWBIECEM00\Corr\AACWBIECEM00_0_3856L.13.doc