

PLOT DRY: C:\ustinsb\mtr\p\driver\windows\ic\color\d14 142817  
MODELNAME: default  
FILENAME: D:\NZA\projects\60046\p2\DRAWING\000\K\ENR\NOL\_ERL\_300\_C\_WKT\_ENS\_M50\_001A.dgn

**LEGEND:**

	PROPOSED AT GRADE ROADS
	PROPOSED UNDERPASS
	OPENING OF UNDERPASS

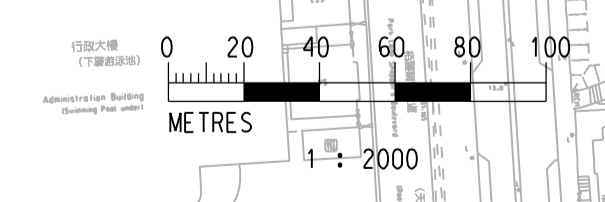

REV	DESCRIPTION	BY	DATE	APPROVED	REV	DESCRIPTION	BY	DATE	APPROVED

DRAWN	YJP
DESIGNED	TWF
CHECKED	KCC
APPROVED	PL
DATE	11/MAR./2009

**MTR**

ROAD WORKS AT WEST KOWLOON

**ENSR | AECOM**

CADD REF. NOL\_ERL\_300\_C\_WKT\_ENS\_M50\_001A.dgn

TITLE		NOL / ERL-300 ENVIRONMENTAL IMPACT ASSESSMENT PROPOSED ROAD WORKS AT WEST KOWLOON	
SCALE	FIGURE NO.	REV.	
1 : 2000 (A1)	NOL/ERL/300/C/WKT/ENS/M50/001	A	

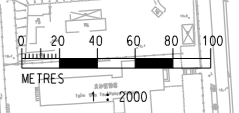
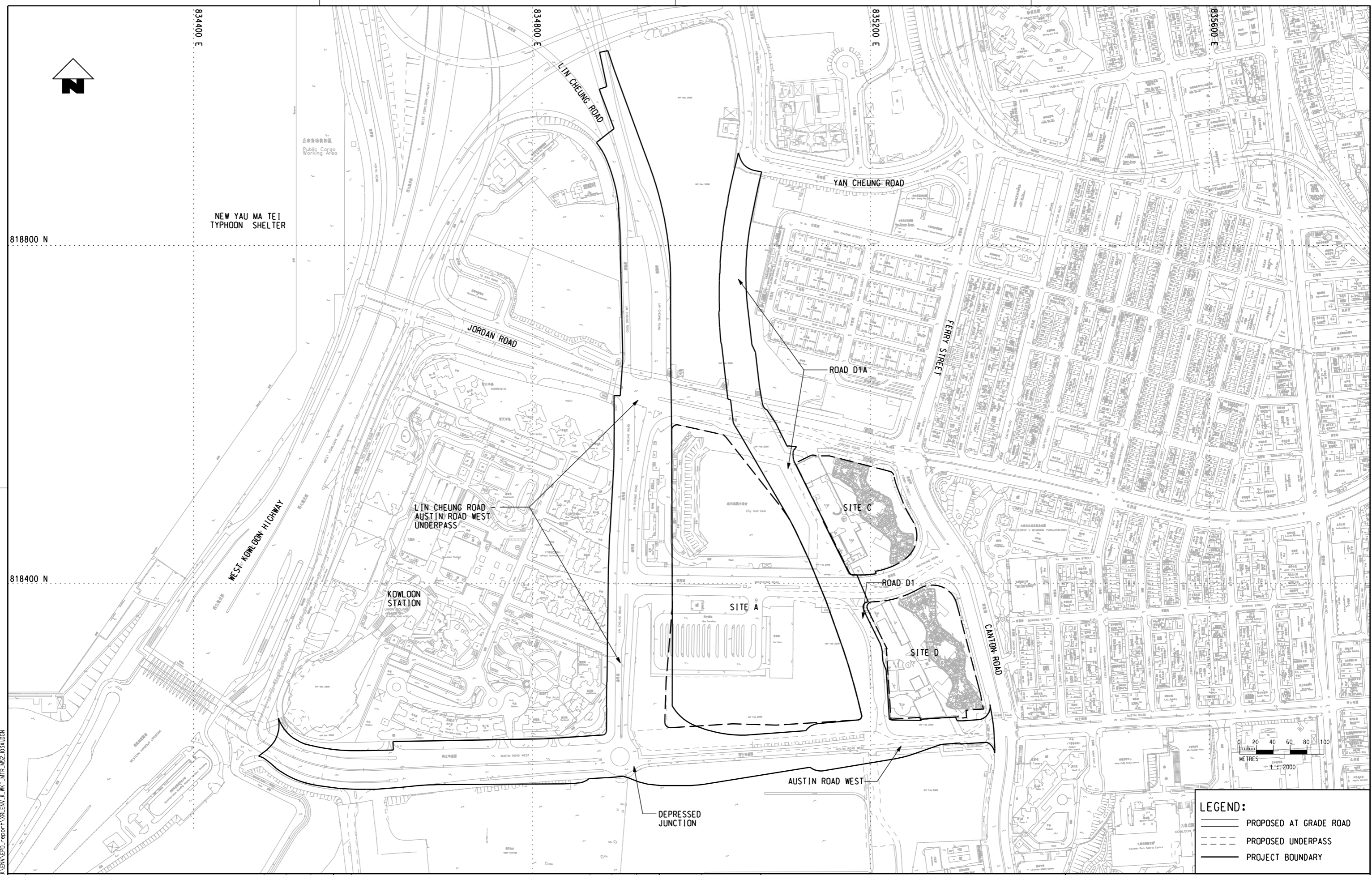

<b>LEGEND:</b>	— PROPOSED AT GRADE ROAD
	- - - PROPOSED UNDERPASS
	— PROJECT BOUNDARY

\A:\D:\DIP\Library\work\spatial\wk\area\plot\dr\PDF\_BM\_300661\_080924.dwg  
 DATE PLOTTED BY: 15/05/2011 15:05:47  
 X:\DIP\LEPHU\XRL\K\ENV\SE\JOB\MTR\M2\_103A1.DGN

DRAWN YCC				MTR	EXPRESS RAIL LINK		TITLE		
DESIGNED MC					PROJECTS DIVISION		ROADWORKS AT WEST KOWLOON		
CHECKED				ORIGINATOR		PROJECT BOUNDARY AND WORKS AREA			
APPROVED				SUSTAINABILITY DEVELOPMENT		DEPARTMENT			
DATE 03/MAY/2011				SCALE					
DO NOT SCALE DRAWINGS. ALL DIMENSIONS SHALL BE VERIFIED ON SITE. © MTR CORPORATION LIMITED 2008. COPYRIGHT IN RESPECT OF THIS DRAWING / DOCUMENT IS OWNED BY MTR CORPORATION LIMITED OF HONG KONG. NO REPRODUCTION OF THE DRAWING / DOCUMENT OR ANY PART BY WHATEVER MEANS IS PERMITTED WITHOUT THE PRIOR WRITTEN CONSENT OF THE MTR CORPORATION LIMITED.				CADD REF. XRLNV_K_WKT_MTR_M52_103A1.DGN				DRAWING NO. XRLNV/K/WKT/MTR/M62/103	
REV	DESCRIPTION	BY	DATE	APPROVED	BY	DATE	REV. A1		
A1	FIRST DRAFT	YCC	19MAY11						

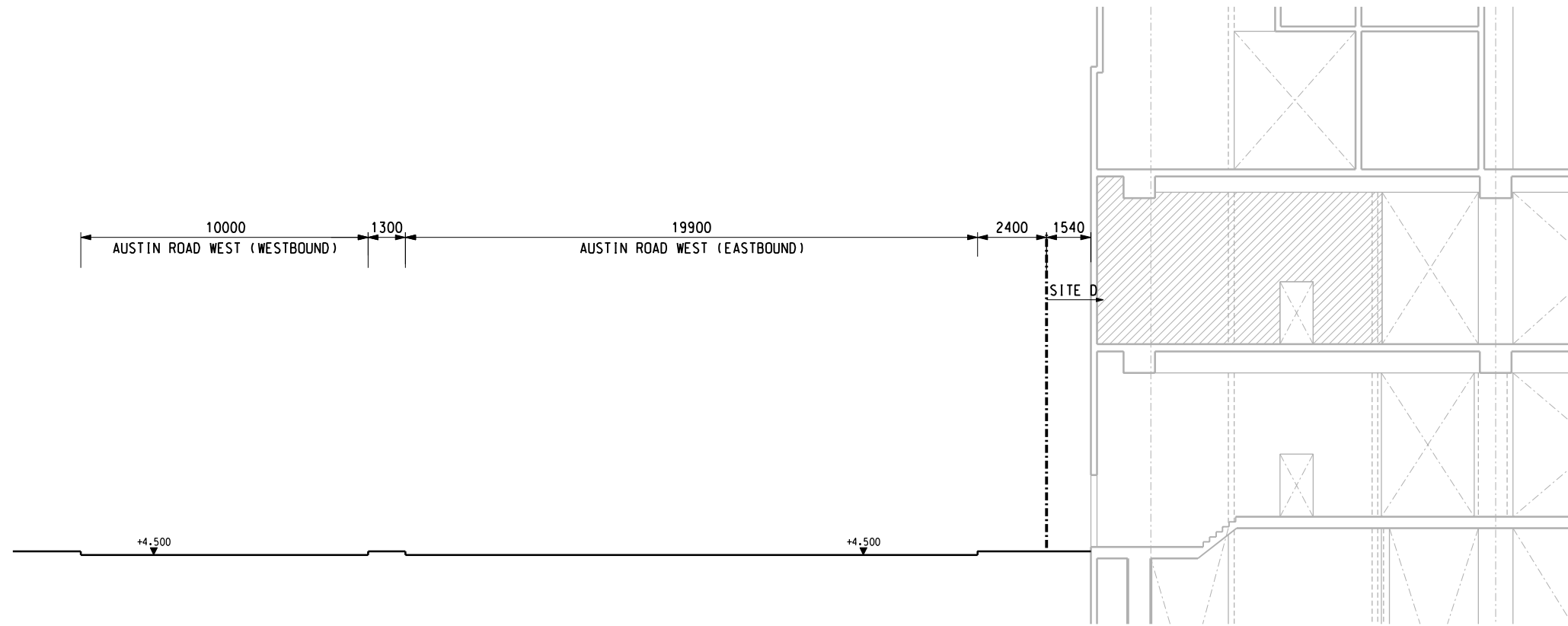

SECTION 9  
SCALE 001

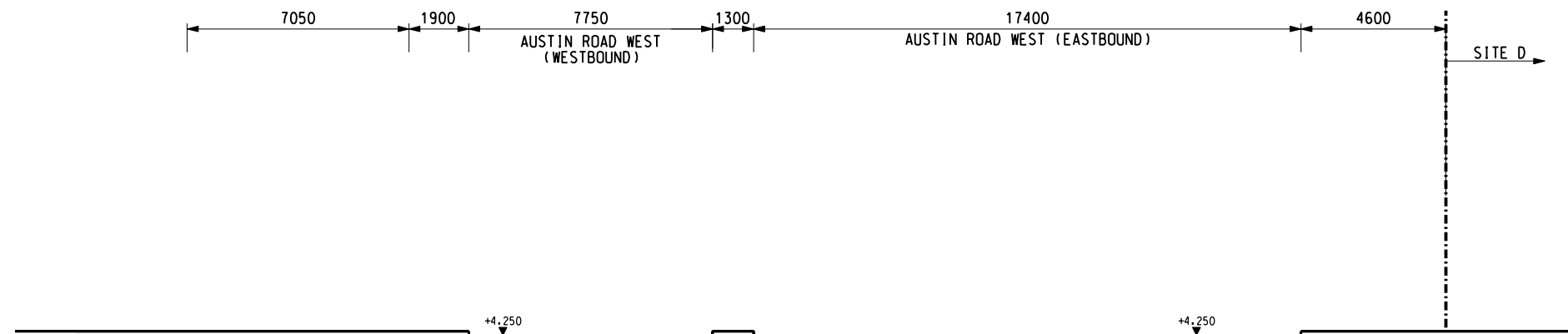

SECTION 10  
SCALE 1 : 200 001

**NOTE:**  
THE DIMENSION SHOWN ON THE DRAWING IS INDICATIVE ONLY AND WILL BE CONFIRMED IN DETAILED DESIGN

PLOT DIR: R:\ustmshet\MTR\PILOTDRIVER\WINDOWS.X3\COLOUR.pht  
 MODELNAME: M50\_010A.dgn  
 FILENAME: R:\ustmshet\MTR\PILOTDRIVER\WINDOWS.X3\COLOUR.pht  
 PRINTED BY: MINGSI  
 2009-5-14 14:47:59  
 PR: D:\projects\60066\42\DRAWING\000\A\ENSR\NOL\_ERL\_300\_C\_WKT\_ENS\_M50\_010A.dgn

REV	DESCRIPTION	BY	DATE	APPROVED	REV	DESCRIPTION	BY	DATE	APPROVED
A	-				---	DDMMYY	---		

DRAWN	HBF		<b>ROAD WORKS AT WEST KOWLOON</b>	
DESIGNED	TWF			
CHECKED	KCC			
APPROVED	PL			
DATE	05/MAY./2009	ORIGINATOR		
<small>DO NOT SCALE DRAWINGS. ALL DIMENSIONS SHALL BE VERIFIED ON SITE.          (C) MTR CORPORATION LIMITED 2008. COPYRIGHT IN RESPECT OF THIS DRAWING / DOCUMENT IS OWNED BY THE MTR CORPORATION LIMITED OF HONG KONG. NO REPRODUCTION OF THE DRAWING / DOCUMENT OR ANY PART BY WHATEVER MEANS IS PERMITTED WITHOUT THE PRIOR WRITTEN CONSENT OF THE MTR CORPORATION LIMITED.</small>			CADD REF.	NOL_ERL_300_C_WKT_ENS_M50_010A.dgn

TITLE		<b>NOL / ERL-300          ENVIRONMENTAL IMPACT ASSESSMENT          SECTIONS OF PROPOSED ROAD WORKS</b>	
SCALE	FIGURE NO.	REV.	
1 : 200 (A3)	NOL/ERL/300/C/WKT/ENS/M50/010	A	

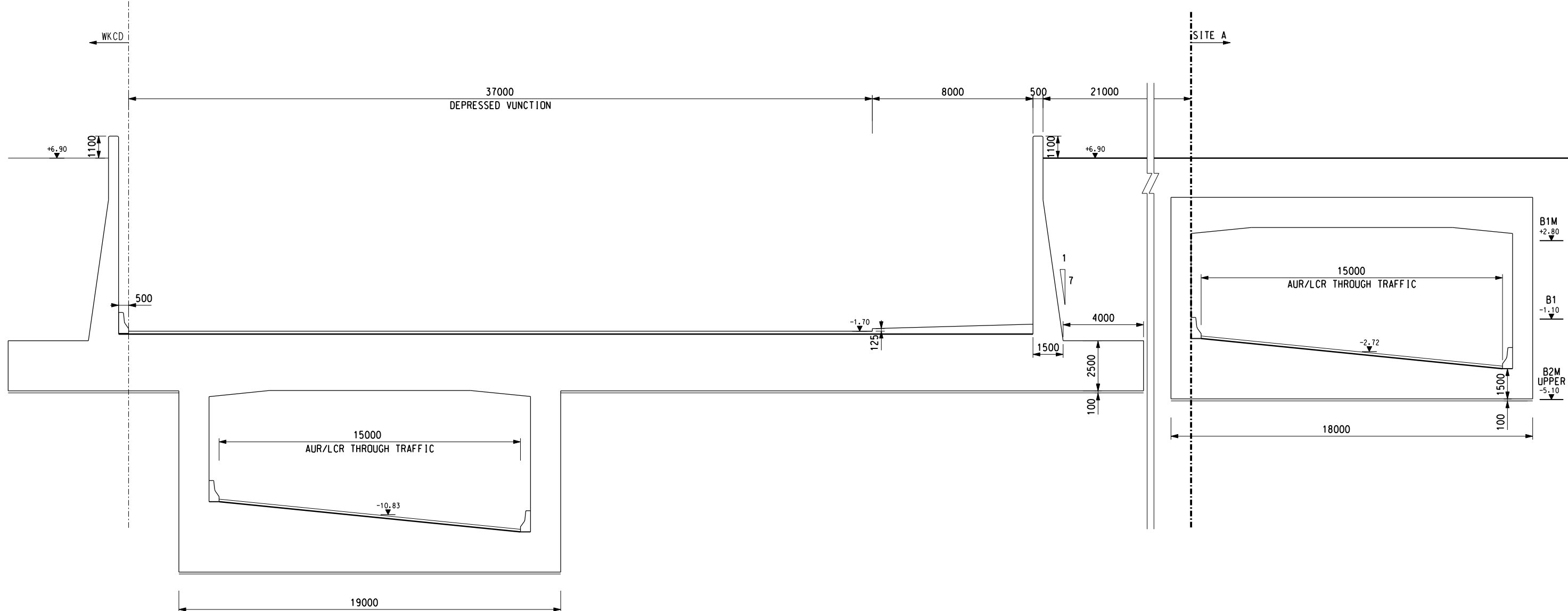



SECTION 8  
SCALE 1 : 200

**NOTE:**  
THE DIMENSION SHOWN ON THE DRAWING IS INDICATIVE ONLY AND WILL BE CONFIRMED IN DETAILED DESIGN

PLOT DIR: R:\usr\mstr\MTR\PROJECTS\NOL\ERL\300\CAD\09A.dgn  
 MODEL NAME: NOL\_ERL\_300\_C\_WKT\_ENS\_M50\_009A.dgn  
 FILE NAME: NOL\_ERL\_300\_C\_WKT\_ENS\_M50\_009A.dgn  
 PRINTED BY: TIANP  
 DATE: 2009-5-13 15:26:53

REV	DESCRIPTION	BY	DATE	APPROVED	REV	DESCRIPTION	BY	DATE	APPROVED

DRAWN	HBF
DESIGNED	TWF
CHECKED	KCC
APPROVED	PL
DATE	05/MAY./2009

ROAD WORKS AT WEST KOWLOON

ORIGINATOR

CADD REF. NOL\_ERL\_300\_C\_WKT\_ENS\_M50\_009A.dgn

TITLE		NOL / ERL-300 ENVIRONMENTAL IMPACT ASSESSMENT SECTIONS OF PROPOSED ROAD WORKS	
SCALE	FIGURE NO.	REV.	
1 : 200 (A3)	NOL/ERL/300/C/WKT/ENS/M50/009	A	

EXISTING BUILDING

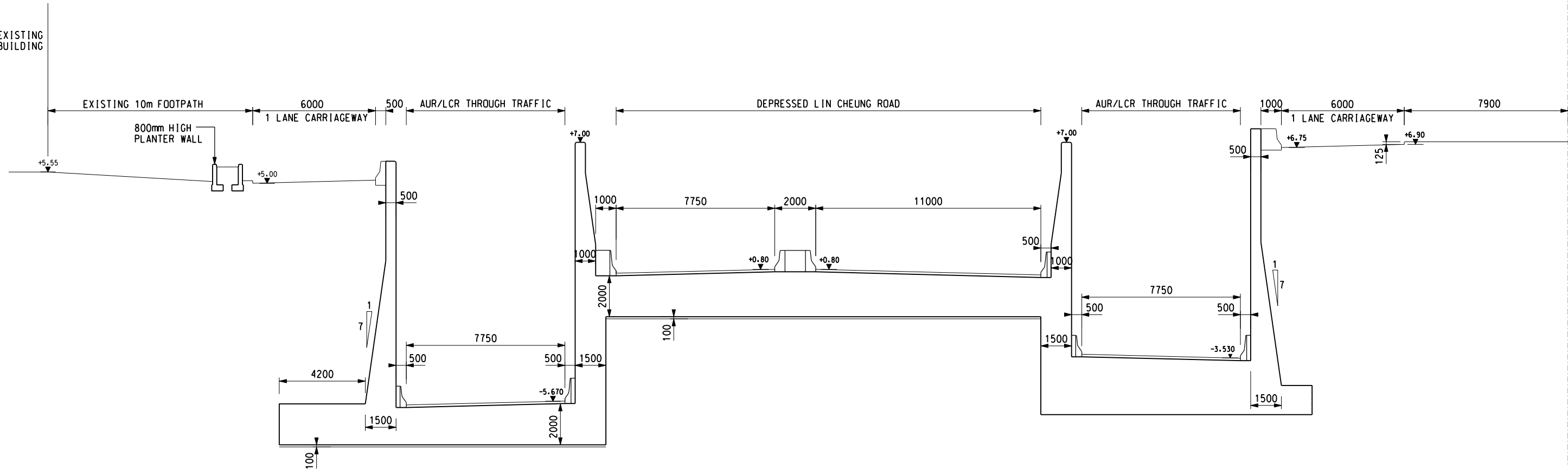

SECTION 7  
SCALE 1 : 200

**NOTE :**  
THE DIMENSION SHOWN ON THE DRAWING IS INDICATIVE ONLY AND WILL BE CONFIRMED IN DETAILED DESIGN

PLOT DIR: R:\ust\mst\mtr\p\ot\DRIVER\WINDOWS\13 COL\016.dwg  
 MODELNAME: D:\GUTJ 2009-5-20 10:43:35  
 FILENAME: P:\pr\016\13\6006\42\URAMING\000\A\ENSR\NOL\_ERL\_300.C\WKT\_ENS\_M50\_008A.dgn

				DRAWN LZG DESIGNED TWF CHECKED KCC APPROVED PL DATE 05/MAY/2009 <small>DO NOT SCALE DRAWINGS. ALL DIMENSIONS SHALL BE VERIFIED ON SITE.          © MTR CORPORATION LIMITED 2008. COPYRIGHT IN RESPECT OF THIS DRAWING / DOCUMENT IS OWNED BY THE MTR CORPORATION LIMITED OF HONG KONG. NO REPRODUCTION OF THE DRAWING / DOCUMENT OR ANY PART BY WHATEVER MEANS IS PERMITTED WITHOUT THE PRIOR WRITTEN CONSENT OF THE MTR CORPORATION LIMITED.</small>						TITLE <b>NOL / ERL-300          ENVIRONMENTAL IMPACT ASSESSMENT          SECTIONS OF PROPOSED ROAD WORKS</b>	
				ORIGINATOR 				SCALE 1 : 200 (A3)			
A FIRST ISSUE				PTC 27FEB09 KC				FIGURE NO. NOL/ERL/300/C/WKT/ENS/M50/008			
REV	DESCRIPTION	BY	DATE	APPROVED	REV	DESCRIPTION	BY	DATE	APPROVED	REV.	
										A	

CADD REF. NOL\_ERL\_300.C\_WKT\_ENS\_M50\_008A.dgn

PLOT DRW: R:\usr\msh\mtr\p\d\DRAWING\WINDOWS\13 COL\019.dwg 15:05:45  
 MODEL NAME: XUCF 2009-5-15  
 FILE NAME: P:\proj\erl\300\300\DRAWING\000\X\ENSR\NOL\_ERL\_300.C\WKT.ENS\_M50\_007A.dgn

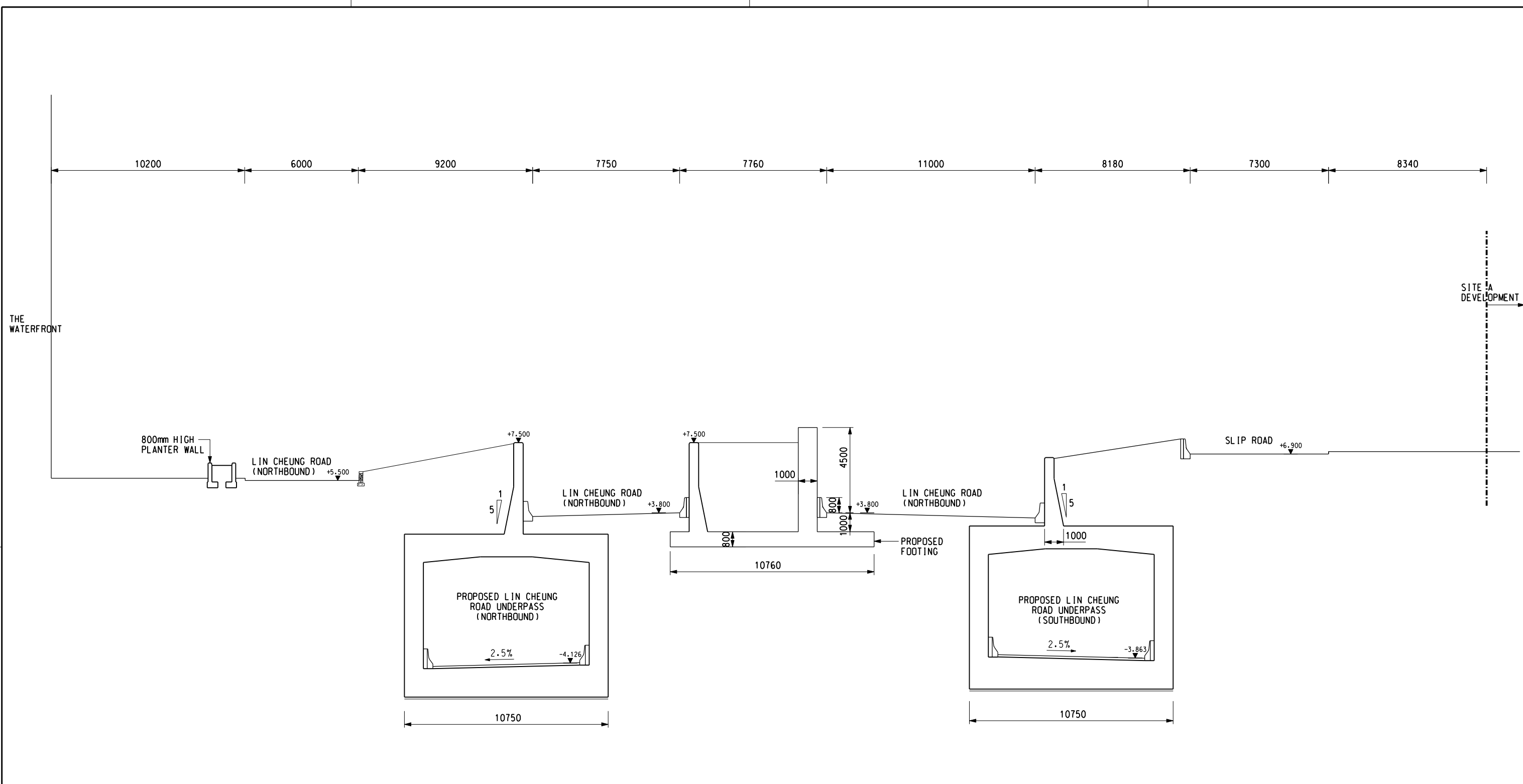

SECTION **6**  
 SCALE 1 : 200

**NOTE:**  
 THE DIMENSION SHOWN ON THE DRAWING IS INDICATIVE ONLY AND WILL BE CONFIRMED IN DETAILED DESIGN

DRAWN LZG					DESIGNED FMH					CHECKED PTC					APPROVED KC					DATE 05/MAY/2009					ORIGINATOR					TITLE																													
										<b>MTR</b> <b>ROAD WORKS AT WEST KOWLOON</b>										<b>NOL / ERL-300</b> <b>ENVIRONMENTAL IMPACT ASSESSMENT</b> <b>SECTIONS OF PROPOSED ROAD WORKS</b>																																							
										<b>ENSR   AECOM</b>																																																	
DO NOT SCALE DRAWINGS. ALL DIMENSIONS SHALL BE VERIFIED ON SITE. © MTR CORPORATION LIMITED 2008. COPYRIGHT IN RESPECT OF THIS DRAWING / DOCUMENT IS OWNED BY THE MTR CORPORATION LIMITED OF HONG KONG. NO REPRODUCTION OF THE DRAWING / DOCUMENT OR ANY PART BY WHATEVER MEANS IS PERMITTED WITHOUT THE PRIOR WRITTEN CONSENT OF THE MTR CORPORATION LIMITED.										CADD REF.										NOL_ERL_300.C\WKT.ENS_M50_007A.dgn										SCALE										FIGURE NO.										REV.									
1 : 200 (A3)										NOL/ERL/300/C/WKT/ENS/M50/007										A																																							

REV	DESCRIPTION	BY	DATE	APPROVED	REV	DESCRIPTION	BY	DATE	APPROVED
A	FIRST ISSUE	PTC	27FEB09	KC					

PLOT DIR: R:\us\msh\mtr\p1\DRIVER\WINDOWS\13 COL\016.dgn  
 MODELNAME: 2009-5-13 15:24:57  
 FILENAME: P:\projects\60066742\DRAWING\000\N\ENSR\NOL\_ERL\_300\_C\_WKT\_ENS\_M50\_006A.dgn

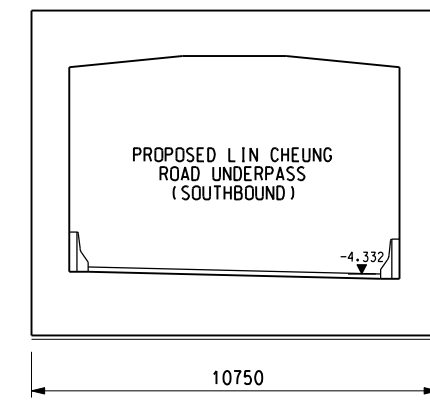
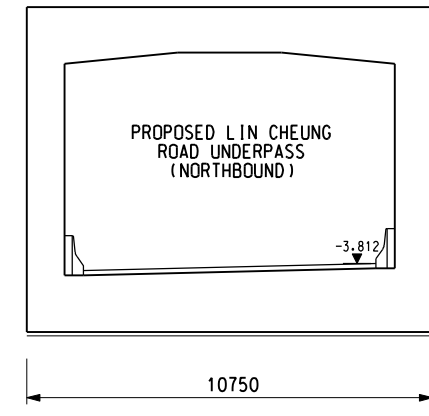
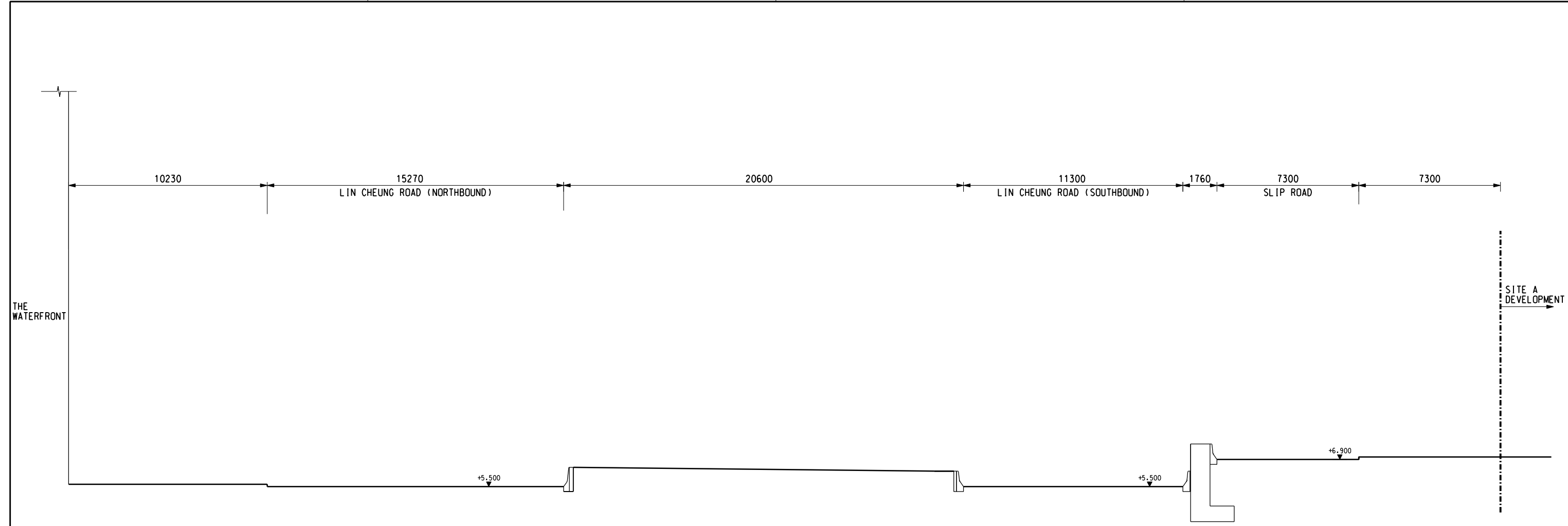

**SECTION 5**  
 SCALE 1 : 200

**NOTE:**  
 THE DIMENSION SHOWN ON THE DRAWING IS INDICATIVE ONLY AND WILL BE CONFIRMED IN DETAILED DESIGN

DRAWN: HBF			TITLE: NOL / ERL-300 ENVIRONMENTAL IMPACT ASSESSMENT SECTIONS OF PROPOSED ROAD WORKS					
DESIGNED: TWF			ROAD WORKS AT WEST KOWLOON					
CHECKED: KCC								
APPROVED: PL			ORIGINATOR					
DATE: 05/MAY./2009		CADD REF.: NOL_ERL_300_C_WKT_ENS_M50_006A.dgn		SCALE: 1 : 200 (A3)				
<small>DO NOT SCALE DRAWINGS. ALL DIMENSIONS SHALL BE VERIFIED ON SITE.        © MTR CORPORATION LIMITED 2008. COPYRIGHT IN RESPECT OF THIS DRAWING / DOCUMENT IS OWNED BY THE MTR CORPORATION LIMITED OF HONG KONG. NO REPRODUCTION OF THE DRAWING / DOCUMENT OR ANY PART BY WHATEVER MEANS IS PERMITTED WITHOUT THE PRIOR WRITTEN CONSENT OF THE MTR CORPORATION LIMITED.</small>		<small>FIGURE NO. NOL/ERL/300/C/WKT/ENS/M50/006</small>		REV. A				
REV	DESCRIPTION	BY	DATE	APPROVED	DESCRIPTION	BY	DATE	APPROVED

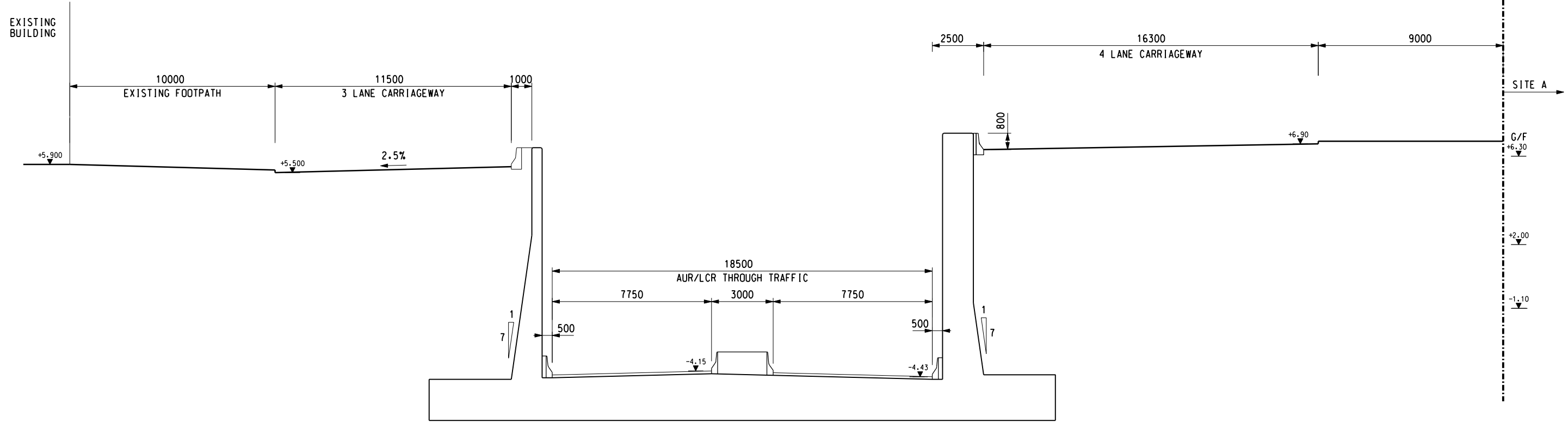

SECTION 4  
SCALE 1 : 200

**NOTE:**  
THE DIMENSION SHOWN ON THE DRAWING IS INDICATIVE ONLY AND WILL BE CONFIRMED IN DETAILED DESIGN

PLOT DIR: R:\ust\set\MTR\PILOT\DRIVER\WINDOWS\13 COL\016.dgn  
 MODELNAME: M50.dgn  
 FILENAME: P:\projects\600642\DRAWING\000\A\ENSR\NOL\_ERL\_300\_C\_WKT\_ENS\_M50\_005A.dgn

DRAWN: HBF DESIGNED: TWF CHECKED: KCC APPROVED: PL DATE: 05/MAY./2009								TITLE: NOL / ERL-300 ENVIRONMENTAL IMPACT ASSESSMENT SECTIONS OF PROPOSED ROAD WORKS	
ORIGINATOR: ENSR   AECOM				ROAD WORKS AT WEST KOWLOON				SCALE: 1 : 200 (A3)	
CADD REF.: NOL_ERL_300_C_WKT_ENS_M50_005A.dgn				FIGURE NO.: NOL/ERL/300/C/WKT/ENS/M50/005				REV.: A	
REV	DESCRIPTION	BY	DATE	APPROVED	REV	DESCRIPTION	BY	DATE	APPROVED



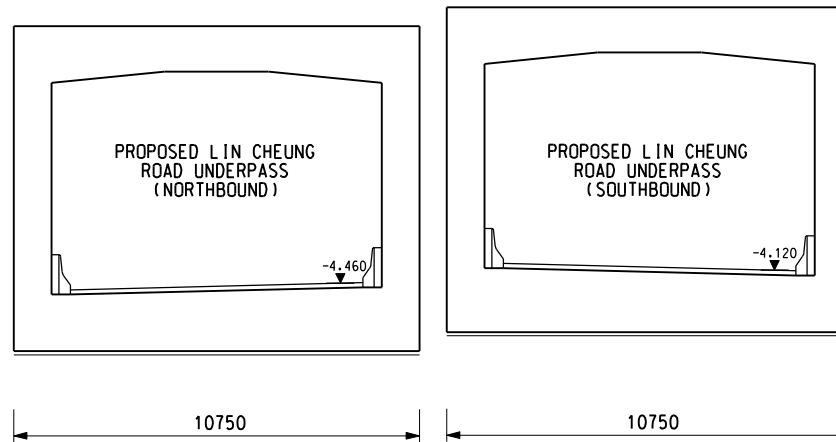
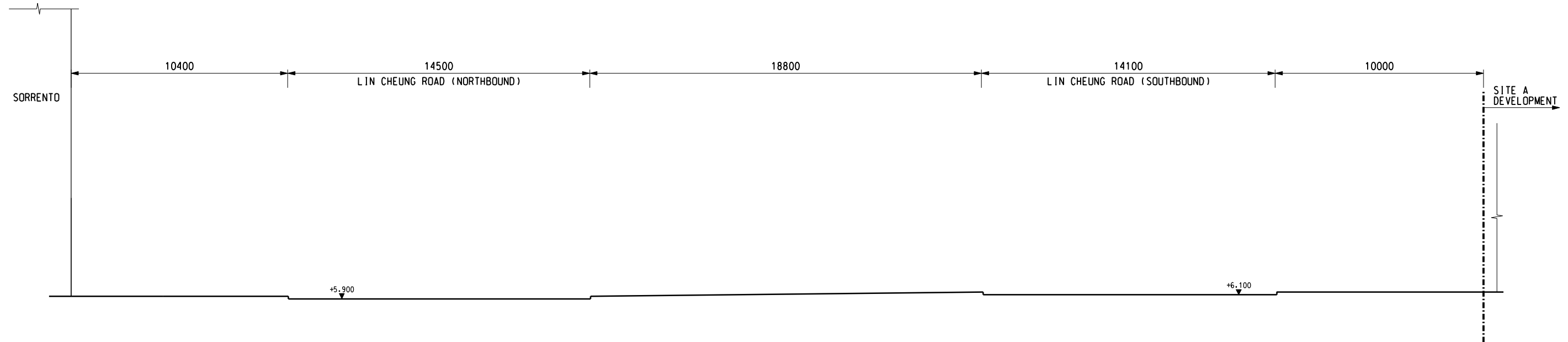

SECTION 3  
SCALE 1 : 200

**NOTE:**  
THE DIMENSION SHOWN ON THE DRAWING IS INDICATIVE ONLY AND WILL BE CONFIRMED IN DETAILED DESIGN

PLOT DIR: R:\us\msh\mtr\p1\DRIVER\WINDOWS\13 COLOUR.ppt 2009-5-13 15:23:32  
 MODELNAME: D:\proj\erl\300\C\WKT\ENS\M50\004.dgn  
 FILENAME: P:\proj\erl\300\C\WKT\ENS\M50\004.dgn

REV	DESCRIPTION	BY	DATE	APPROVED	REV	DESCRIPTION	BY	DATE	APPROVED

DRAWN	HBF
DESIGNED	TWF
CHECKED	KCC
APPROVED	PL
DATE	05/MAY./2009

**MTR**  
**ROAD WORKS AT WEST KOWLOON**  
**ENSR | AECOM**  
 ORIGINATOR  
 CADD REF. NOL\_ERL\_300\_C\_WKT\_ENS\_M50\_004.dgn

TITLE NOL / ERL-300 ENVIRONMENTAL IMPACT ASSESSMENT SECTIONS OF PROPOSED ROAD WORKS	
SCALE 1 : 200 (A3)	FIGURE NO. NOL/ERL/300/C/WKT/ENS/M50/004
REV. A	



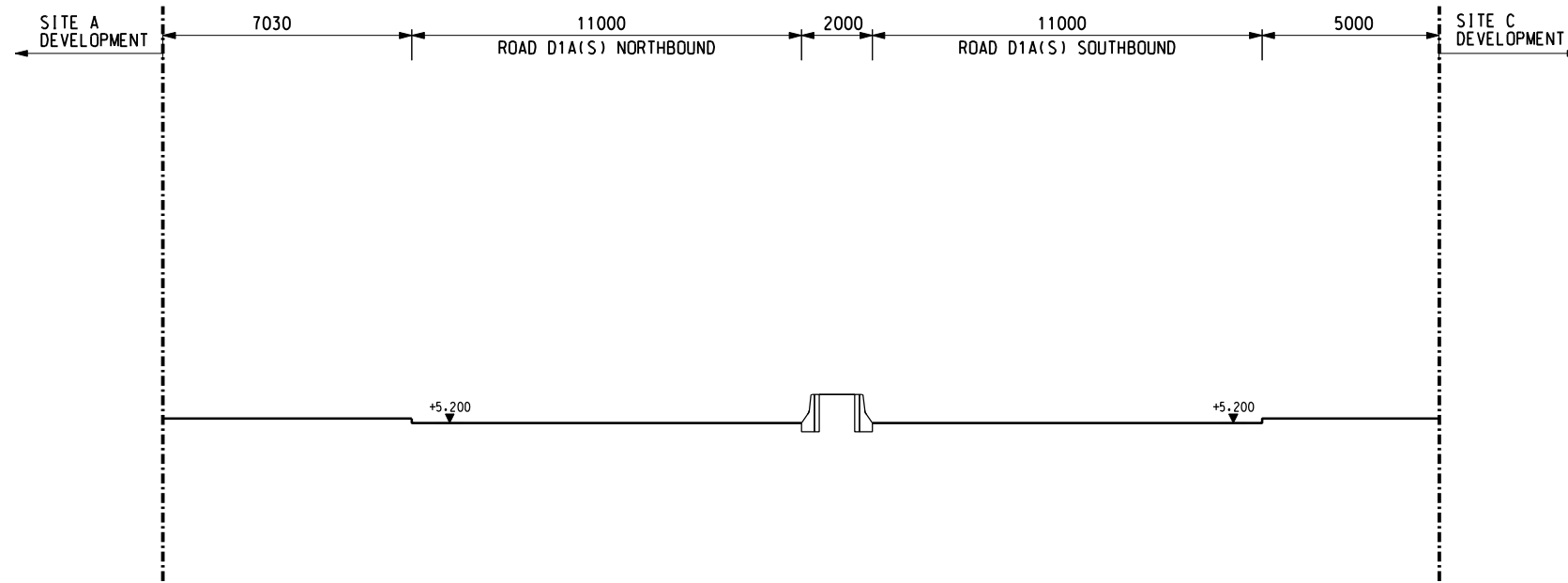

SECTION 1  
SCALE 1 : 200

**NOTE:**  
THE DIMENSION SHOWN ON THE DRAWING IS INDICATIVE ONLY AND WILL BE CONFIRMED IN DETAILED DESIGN

PLOT DIR: R:\usr\msh\mtr\p1\driver\windows\13\color\p1h 2009-5-13 15:26:59  
 MODELNAME: PRJ\PROJECTS\60066742\DRAWING\000\A\ENSR\NOL\_ERL\_300\_C\_WKT\_ENS\_M50\_002A.dgn  
 FILENAME:

REV	DESCRIPTION	BY	DATE	APPROVED	REV	DESCRIPTION	BY	DATE	APPROVED
A	-								

DRAWN	HBF
DESIGNED	TWF
CHECKED	KCC
APPROVED	PL
DATE	05/MAY./2009

**MTR**

ROAD WORKS AT WEST KOWLOON









**ENSR | AECOM**

ORIGINATOR

CADD REF. NOL\_ERL\_300\_C\_WKT\_ENS\_M50\_002A.dgn

TITLE		NOL / ERL-300	
ENVIRONMENTAL IMPACT ASSESSMENT		SECTIONS OF PROPOSED ROAD WORKS	
SCALE	FIGURE NO.	REV.	
1 : 200 (A3)	NOL/ERL/300/C/WKT/ENS/M50/002	A	

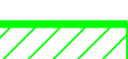
**LEGEND:**

-  5.5m HIGH VERTICAL BARRIER
-  5.5m HIGH CANTILEVER BARRIER WITH 2.5m CANTILEVER AT 45°
-  5.5m HIGH CANTILEVER BARRIER WITH 3m CANTILEVER AT 45°
-  5.5m HIGH CANTILEVER BARRIER WITH 4m CANTILEVER AT 45°
-  5.5m HIGH CANTILEVER BARRIER WITH 4.5m CANTILEVER AT 45°
-  5.5m HIGH SEMI-ENCLOSURE
-  LANDSCAPE DECK / SEMI - ENCLOSURE
-  LANDSCAPE DECK AND ELEVATED WALKWAY

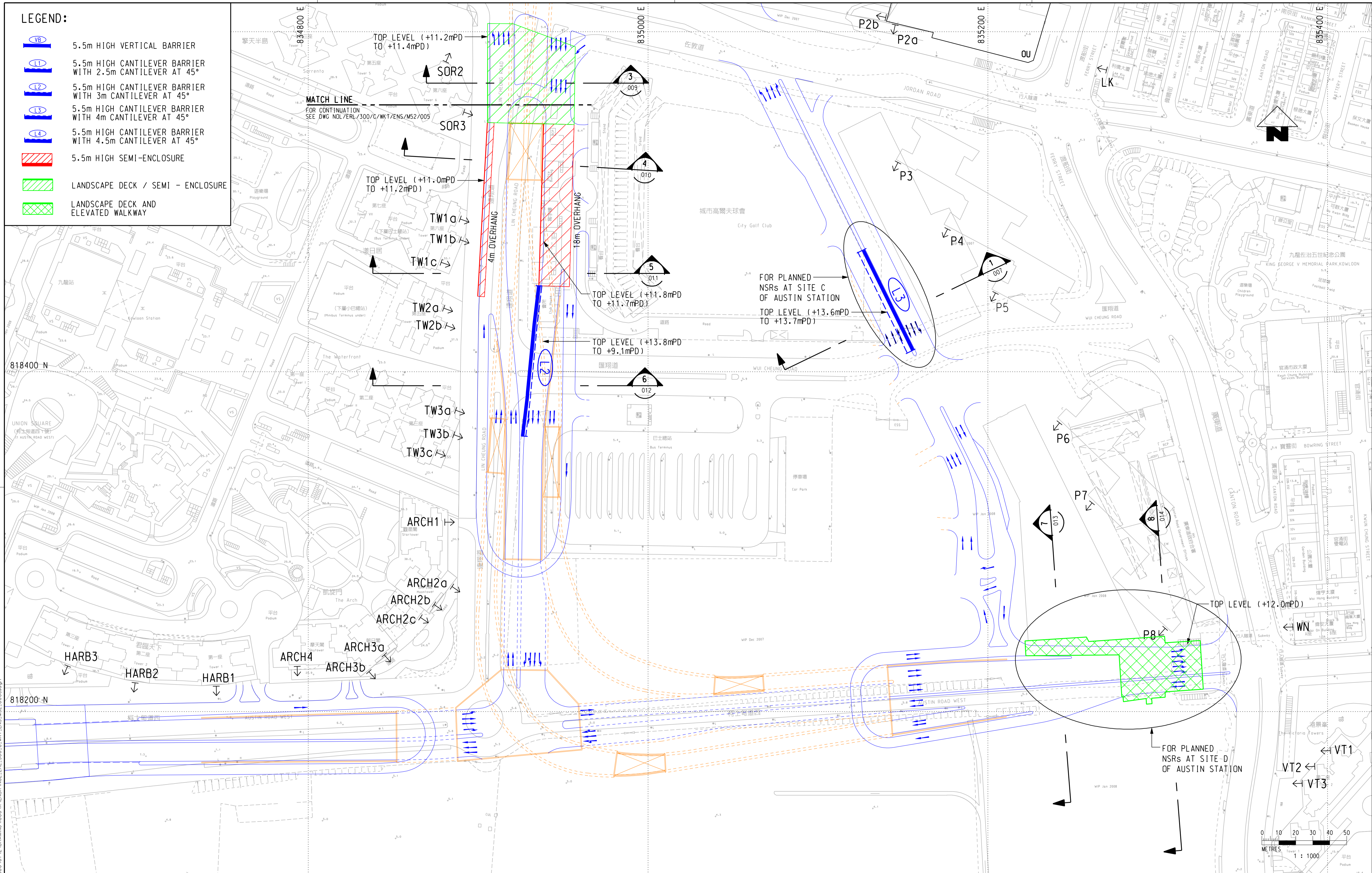

PLOT DRW: C:\usr\mtr\p1\DRIVER\WINDOWS\MICROSOFT\...  
 MODELNAME: NOL\_ERL\_300\_C\_WKT\_ENS\_M52\_006C.dgn  
 FILENAME:

REV	DESCRIPTION	BY	DATE	APPROVED	REV	DESCRIPTION	BY	DATE	APPROVED

DRAWN	HY
DESIGNED	TWF
CHECKED	KCC
APPROVED	PL
DATE	30/JUL/2009







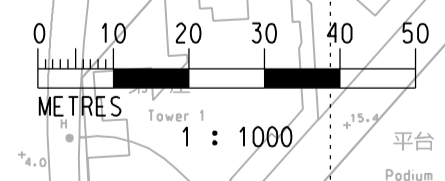



**MTR**  
 ROAD WORKS AT WEST KOWLOON  

 ENSR | AECOM  
 ORIGINATOR  
 CADD REF. NOL\_ERL\_300\_C\_WKT\_ENS\_M52\_006C.dgn

TITLE  
**NOL / ERL-300 ENVIRONMENTAL IMPACT ASSESSMENT LOCATIONS OF PROPOSED NOISE SCREENING STRUCTURES**  
 SCALE 1 : 1000 (A1)  
 FIGURE NO. NOL/ERL/300/C/WKT/ENS/M52/006  
 REV. C

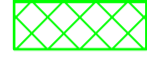

**LEGEND:**

-  5.5m HIGH VERTICAL BARRIER
-  5.5m HIGH CANTILEVER BARRIER WITH 2.5m CANTILEVER AT 45°
-  5.5m HIGH CANTILEVER BARRIER WITH 3m CANTILEVER AT 45°
-  5.5m HIGH CANTILEVER BARRIER WITH 4m CANTILEVER AT 45°
-  5.5m HIGH CANTILEVER BARRIER WITH 4.5m CANTILEVER AT 45°
-  6m HIGH CANTILEVER BARRIER WITH 3m CANTILEVER AT 45°
-  5.5m HIGH SEMI-ENCLOSURE
-  LANDSCAPE DECK / SEMI-ENCLOSURE
-  LANDSCAPE DECK AND ELEVATED WALKWAY

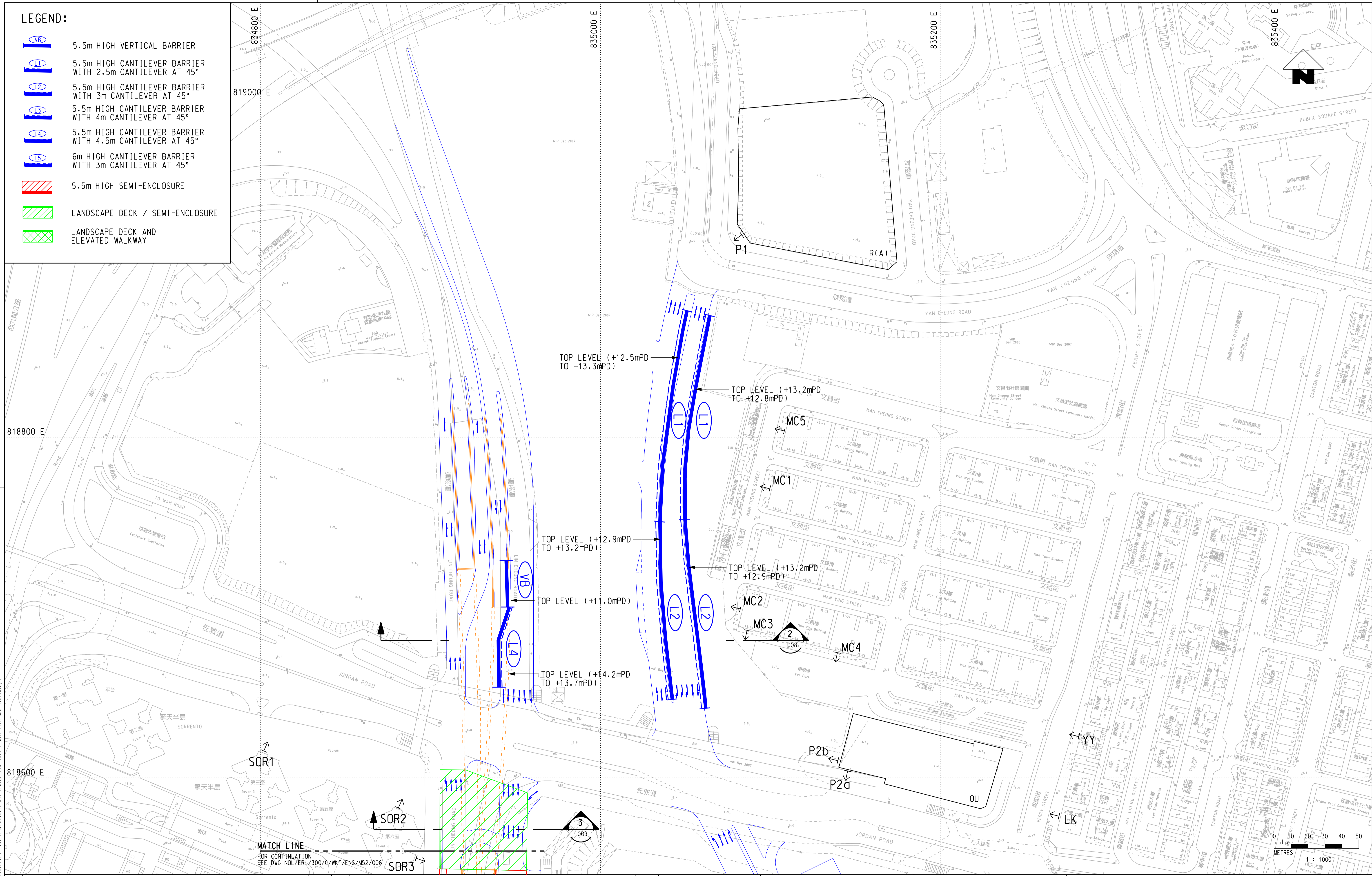

PLOT DRW: C:\usr\mtr\p1\DRIVER\WINDOWS\MICROSOFT\...  
 MODELNAME: NOL/ERL/300/C/WKT/ENS/M52/005B.dgn  
 PLENAME:

DRAWN	YJP
DESIGNED	TWF
CHECKED	KCC
APPROVED	PL
DATE	18/JUN./2009
DO NOT SCALE DRAWINGS. ALL DIMENSIONS SHALL BE VERIFIED ON SITE. © MTR CORPORATION LIMITED 2008. COPYRIGHT IN RESPECT OF THIS DRAWING / DOCUMENT IS OWNED BY THE MTR CORPORATION LIMITED OF HONG KONG. NO REPRODUCTION OF THE DRAWING / DOCUMENT OR ANY PART BY WHATEVER MEANS IS PERMITTED WITHOUT THE PRIOR WRITTEN CONSENT OF THE MTR CORPORATION LIMITED.	

**MTR**

**ROAD WORKS AT WEST KOWLOON**

**ENSR | AECOM**

CADD REF. NOL\_ERL\_300\_C\_WKT\_ENS\_M52\_005B.dgn

TITLE		NOL / ERL-300 ENVIRONMENTAL IMPACT ASSESSMENT LOCATIONS OF PROPOSED NOISE SCREENING STRUCTURES	
SCALE	FIGURE NO.	REV.	
1 : 1000 (A1)	NOL/ERL/300/C/WKT/ENS/M52/005	B	



834000 E

834800 E

835200 E

835600 E

818800 N

818400 N

公眾貨物積卸區  
Public Cargo Working Area

新油麻地避風塘  
New Yau Ma Tei  
Typhoon Shelter

R(A)

OU

SITE A

SITE C  
R(A)2

SITE D  
R(A)2

**LEGEND:**

 LOW NOISE ROAD SURFACING  
ON NEW ROADS UNDER THE  
PROJECT

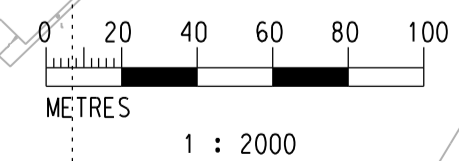

PLOT DRY: C:\usr\mtr\p1\DRIVER\WINDOWS\MICROSOFT\...  
 MODELNAME: NOL\_ERL\_300\_C\_WKT\_ENS\_M52\_004A.dgn  
 FILENAME:

REV	DESCRIPTION	BY	DATE	APPROVED	REV	DESCRIPTION	BY	DATE	APPROVED

DRAWN	DK
DESIGNED	FMH
CHECKED	PTC
APPROVED	KC
DATE	21/APR/2009

**MTR**

ROAD WORKS AT WEST KOWLOON

**ENSR | AECOM**

ORIGINATOR

CADD REF. NOL\_ERL\_300\_C\_WKT\_ENS\_M52\_004A.dgn

TITLE		NOL / ERL-300 ENVIRONMENTAL IMPACT ASSESSMENT EXTENT OF LOW NOISE ROAD SURFACE ON NEW ROADS UNDER THE PROJECT	
SCALE	FIGURE NO.	SCALE	FIGURE NO.
1 : 2000 (A1)	NOL/ERL/300/C/WKT/ENS/M52/004	1 : 2000 (A1)	NOL/ERL/300/C/WKT/ENS/M52/004
REV.	A	REV.	A