



CONTRACT NO: SD 15/2022

**OUTLYING ISLAND SEWERAGE STAGE 2 – SOUTH LANTAU SEWAGE
WORKS – ENVIRONMENTAL TEAM SERVICES (2023 – 2024)**

UNDER ENVIRONMENTAL PERMIT NO. EP-538/2017

MONTHLY ENVIRONMENTAL MONITORING & AUDIT REPORT

**MARCH 2024
REVISION 1**

CLIENTS:

Drainage Services Department

PREPARED BY:

Lam Environmental Services Limited

19/F, Remex Centre,
42 Wong Chuk Hang Road,
Hong Kong

Telephone: (852) 2882-3939
Facsimile: (852) 2882-3331
E-mail: info@lamenviro.com
Website: <http://www.lamenviro.com>

CERTIFIED BY:

Derek Lo
Environmental Team Leader

DATE:

11 April 2024



Member of the Surbana Jurong Group

local people
global experience

Our Ref: 7076811/L30811/AG/KL/TK/KCL/rw

11 April 2024

Drainage Services Department
Sewage Services Branch
Special Duty Division Group 3
42/F Revenue Tower
5 Gloucester Road
Wan Chai, Hong Kong

By Email and Post
(kschan04@dsd.gov.hk)

Attn: Mr. Silas CHAN

Dear Sir

Contract No. SD 7/2020
Independent Environmental Checker ("IEC") for Environmental Monitoring Work for
South Lantau Sewerage Works
Verification of Monthly EM&A Report (March 2024)

With reference to the Monthly EM&A Report (March 2024) Revision 1 dated and certified by the ET Leader on 11 April 2024, please note that we have no adverse comments on the captioned and we hereby verify the captioned in accordance with Condition 3.4 of the Environmental Permit No. EP-538/2017.

Should you have questions please do not hesitate to contact the undersigned at tel. 3995-8140 or by email to kitty.lee@smec.com

Yours faithfully

Kitty LEE
Independent Environmental Checker

CC	Binnies	- Mr. Kevin CHAN	by email
	Lam	- Mr. Derek LO / Mr. Raymond DAI	by email
	KLCW-JV	- Mr. Charles Yeung	by email

SMEC ASIA LIMITED
27/F Ford Glory Plaza, 37-39 Wing Hong Street
Cheung Sha Wan, Kowloon, Hong Kong
T +852 3995 8100
F +852 3995 8101
E hongkong@smec.com
W www.smec.com



ECO-Healthy
WORKPLACE



TABLE OF CONTENTS

1	Introduction	6
1.1	Scope of the Report.....	6
1.2	Structure of the Report.....	6
2	Basic project Information and Environmental Status	8
2.1	Basic Project Information.....	8
2.2	Construction Programme.....	8
2.3	Works undertaken during the month.....	9
2.4	Drawing showing the project area, environmental sensitive receivers and monitoring locations.....	9
3	Implementation Status	9
3.1	Advice on the implementation status of environmental protection and pollution control/mitigation measures	9
3.2	Environmental Mitigation Measures.....	10
3.3	Environmental monitoring requirements and contractual requirements	10
3.4	Site Inspection and Audit Reports	11
4	Monitoring Results	13
4.1	Noise Monitoring	13
4.2	Water Quality Monitoring	16
4.3	Ecology	20
4.4	Waste Management	21
5	Complaints, Notification of Summons and Prosecution.....	23
6	Future Key Issues	25
7	Conclusion	26
7.1	Noise Monitoring	26
7.2	Water Quality Monitoring	26
7.3	Ecological Impact Monitoring	26
7.4	Review of the Reasons for and the Implications of Non-compliance	27
7.5	Summary of action taken in the event of and follow-up on non-compliance	27

LIST OF TABLES

Table 3.1	Summary of submission status under EP-538/2017
Table 3.2	Summary of the current status on licences and/or permits on environmental protection pertinent to the Project
Table 3.3	Summary of Environmental Inspections
Table 4.1	Noise Monitoring Equipment
Table 4.2	Noise Monitoring Station
Table 4.3	Water Quality Monitoring Equipment
Table 4.4	Marine Water Quality Stations for Water Quality Monitoring
Table 4.5	Action and Limit Levels of Water Quality
Table 4.6	Summary of Marine Water Quality Exceedances
Table 4.7	Summary of Quantities of Waste Material
Table 5.1	Cumulative Statistics on Complaints
Table 5.2	Summary of Complaints
Table 5.3	Cumulative Statistics on Successful Prosecutions
Table 6.1	Construction Activities and Recommended Mitigation Measures in Coming Reporting 3 Months

LIST OF FIGURES

- [Figure 2.1 Master Layout Plan](#)
- [Figure 2.2 Contract Layout Plan](#)
- [Figure 2.3 Locations of Noise Monitoring Station](#)
- [Figure 2.4 Locations of Water Quality Monitoring Stations](#)
- [Figure 2.5 Mark up Figure 5.4i extracted from approved EIA Report \(AEIAR-210/2017\)](#)
- [Figure 2.6 Location Plan for Temporary Holding Nursery](#)
- [Figure 2.7 Typical Details of Proposed Silt Curtain](#)

LIST OF APPENDICES

- [Appendix 4.1 Copies of Calibration Certificates](#)
- [Appendix 4.2 Impact Monitoring Schedule for Reporting Month and Next Month](#)
- [Appendix 4.3 Noise Monitoring Results and Graphical Presentations](#)
- [Appendix 4.4 Marine Water Quality Monitoring Results and Graphical Presentations](#)
- [Appendix 4.5 Monthly Summary Waste Flow Table](#)
- [Appendix 6.1 3 Months Rolling Programme](#)

EXECUTIVE SUMMARY

- i. This is the Monthly Environmental Monitoring and Audit (EM&A) Report – **March 2024** for the Outlying Islands Sewerage Stage 2 – South Lantau Sewerage Works under Environmental Permit No. EP-538/2017 (Hereafter as “the Project”). The construction works of the Project was commenced on **3 November 2021** and the tentative completion date is **Q1 2026**. This Monthly EM&A Report presents the environmental monitoring findings and information recorded during the period of **1 to 31 March 2024**. The cut-off date of reporting is at the end of each reporting month.
- ii. In the reporting period, the principal work activities undertaken are as follows:
 - **Excavation, sewer laying, construction of manhole at Pui O Lo Uk Tsuen, South Lantau road, Pui O Beach**
 - **Excavation and site formation at San Shek Wan Sewage Treatment Works (SSWSTW) and Pui O Sewage Pumping Station (POSPS)**
 - **Horizontal Directional Drilling (HDD) works at marine**
 - **Removal works of Excavation and Lateral Support (ELS)**
 - **Excavation and Lateral Support (ELS) works**
 - **Superstructure Reinforced Concrete (RC) Works**

Exceedances of Action/Limit Levels

Noise Monitoring

- iii. Noise monitoring was conducted at **eight (8)** noise monitoring stations (*N12a, N12b, N13, N14, N15b, N16a, N16b and N17*) once per week in the reporting period.
- iv. **School examination was taken place at N17 – Bui O Public School from 4 to 6 March 2024 in the reporting period, the limit level of noise monitoring station N17-Bui O Public School was adjusted accordingly to 65dB(A) during the period.**
- v. **No Action/Limit Level exceedances were recorded in this reporting period.**

Water Quality Monitoring

- vi. **Water quality monitoring (WQM) had been commenced on 12 April 2022 the designated monitoring stations three days per week with respect to marine-based construction works commenced on 19 April 2022. HDD casing works commenced on 30 May 2022.**
- vii. **Water quality monitoring on 9 (mid-ebb and mid-flood), 13 (mid-ebb) March 2024 were cancelled due to Strong Monsoon Signal. No substitution would be arranged for such cancellation since it is impossible to maintain the monitoring frequency as three times a week for the event of marine water quality monitoring cancellation in between time with respect to the fact that not less than 36 hours interval shall be followed for two monitoring days as required by the EM&A Manual Clause 5.1.6 (b) for the project.**

- viii. In accordance with the action level and limit level in Baseline Monitoring Report Rev. 9.2 agreed by EPD on 2 September 2022, no action level and limit level exceedances were recorded in the reporting month.

Ecological Impact Monitoring

- ix. Transplanting of the trees of *Aquilaris sinensis* was completed on 26 April 2022. Maintenance works for trees in holding nursery have commenced.
- x. As per latest version of PTP, four tree found (1 no. of *Aquilaria sinensis* and 3 nos. of *Gmelina chinensis*) within the site of SSWSTW which are considered to be the plant species with conservative importance for temporarily transplanted to the nursery at Kam Tin and eventually be transplanted to Pui O Pumping Station.
- xi. The weekly site audit was carried out by ET include checking whether good site practices are being properly implemented by the Contractor.
- xii. The extent of the work site boundaries was checked by the ET during the weekly site audit.

Complaint log

- xiii. No environmental complaint regarding the construction works was recorded in the reporting period.

Notifications of Any Summons and Successful Prosecutions

- xiv. No environmental notification of any summons and successful prosecution regarding the construction works was recorded in the reporting period.

Reporting Changes

- xv. There are no particular reporting changes.

Future Key Issues

- xvi. In coming reporting 3 months, the scheduled construction activities are listed as follows:
- Excavation, sewer laying, construction of manhole at Pui O Lo Uk Tsuen, South Lantau Road, Pui O Beach
 - Dredging at marine
 - Site formation works
 - Drilling works
 - Excavation works
 - ELS works
 - Superstructure RC Works
 - Removal works of ELS
- xvii. Key construction activities for the next three months with the recommended mitigation measures to be implemented are presented as follows:



Key Construction Works	Recommended Mitigation Measures
<ul style="list-style-type: none">Excavation, sewer laying, construction of manhole at Pui O Lo Uk Tsuen, South Lantau Road, Pui O BeachDredging at marineSite formation worksDrilling worksExcavation worksELS worksSuperstructure RC WorksRemoval works of ELS	<ul style="list-style-type: none">Implementation of noise pollution control in accordance with Construction Noise Mitigation Plan;Dust control during dust generating works;Silt curtain should be maintained in good condition;Adopt surface drainage and sediment control facilities for sewage installation in village and public roads;Adopt temporary drainage and sediment control facilities on Site;Vehicle wheel-washing and body washing facilities should be provided at the site entrance;Regular water spraying on excavation works for dust control; andProper waste handling, recycling and storage.

Introduction

1.1 Scope of the Report

- 1.1.1. Lam Environmental Services Limited (LES) has been appointed to work as the Environmental Team (ET) under Environmental Permit (EP) No. EP-538/2017 to implement the Environmental Monitoring and Audit (EM&A) programme as stipulated in the EM&A Manual of the approved Environmental Impact Assessment (EIA) Report for the Outlying Islands Sewerage Stage 2 – South Lantau Sewerage Works (Register No.: AEIAR-210/2017).
- 1.1.2. In accordance with Clause 3.4 stated in EP-538/2017, 4 hard copies and 1 electronic copy of Monthly EM&A Report shall be submitted to the Director within 2 weeks after the end of each reporting month.
- 1.1.3. According to Section 12.2 of the Project EM&A Manual, the Monthly EM&A Report should be submitted within 10 working days of the end of each reporting month, with the first report due in the month after construction commences.

1.2 Structure of the Report

Section 1 *Introduction* – details the scope and structure of the report.

Section 2 *Basic project Information and Environmental Status* – summarizes project organization and key personnel contact, construction programme and works undertaken for the month. Construction programme, works undertaken during the month with illustrations, drawing showing the project area, environmental sensitive receivers and monitoring locations.

Section 3 *Implementation Status* – advice on the implementation status of environmental protection and pollution control/mitigation measures, as recommended in the EIA Report and summarised in the updated implementation schedule.

Section 4 *Monitoring Results* – summarizes the monitoring results obtained in the reporting period, including monitoring methodology, name of laboratory and equipment used and calibration details, parameters monitored, monitoring locations (and depth), monitoring date, frequency, and duration.

Section 5 *Report on Complaints, Notification of Summons and Successful Prosecutions* – summarizes:

Record of all complaints received (written or verbal) for each media, including locations and nature of complaints investigation, liaison and consultation undertaken, actions and follow-up procedures taken, results and summary;
Record of notifications of summons and successful prosecutions for breaches of the current environmental protection/pollution control legislations, including locations and nature of the breaches, investigation, follow-up actions taken,

results and summary;

Review of the reasons for and the implications of non-compliance, complaints, summons and prosecutions including review of pollution sources and working procedures; and

Description of the actions taken in the event of non-compliance and deficiency reporting and any follow-up procedures related to non-compliance.

Section 6 ***Future Key Issues*** – An account of the future key issues as reviewed from the works programme and work method statements.

Section 7 ***Conclusion***

2 Basic project Information and Environmental Status

2.1 Basic Project Information

2.1.1. Drainage Services Department is the overall project controllers for the Project. For the construction phase of the Project, Contractor(s), Environmental Team and Independent Environmental Checker are appointed to manage and control environmental issues. Key personnel and contact particulars are summarized in **Table 2.1**:

Table 2.1 Contact Details of Key Personnel

Party	Role	Post	Name	Contact No.	Contact Fax
Drainage Services Department (DSD)	The Engineer for the Contract	Engineer	Mr. Silas Chan	2594 7272	3104 6426
Binnies Hong Kong Limited	Engineer's Representative	Resident Engineer	Mr. Kevin Chan	3529 3013	-
Kwan Lee – Chun Wo Joint Venture	Contractor	Site Agent	Mr. Charles Yeung	6128 2606	2744 6937
		Environmental Officer	Ms. Shirley Kong	5162 5933	
SMEC Hong Kong	Independent Environmental Checker (IEC)	Independent Environmental Checker (IEC)	Ms. Kitty Lee	3995 8140	3995 8101
Lam Environmental Services Limited	Environmental Team (ET)	Environmental Team Leader (ETL)	Mr. Derek Lo	2882 3939	2882 3331

2.2 Construction Programme

2.2.1. The proposed sewerage works will collect the sewage generated from the unsewered areas of Shui Hau, Tong Fuk, Cheung Sha, San Shek Wan, Pui O and Ham Tin in South Lantau (i.e. within the Project Catchment Area) and convey it to a proposed sewage treatment works at San Shek Wan for treatment and disposal into outer bay of Pui O/ Chi Ma Wan via a submarine outfall.

2.2.2. The entire Project are divided into three contracts. Contract No. DC/2020/20 (the Contract) would have the following implementations as demonstrated in [Figure 2.1](#).

2.2.3. The major components of the Contract under Environmental Permit (EP) (EP No. EP-538/2017) comprises: (i) construction of secondary sewage treatment works (STW) at San Shek Wan in South Lantau; (ii) construction of sewage pumping station (SPS) at Pui O, San Shek Wan, Cheung Sha and Cheung Fu Street; (iii) construction of about 1.4 kilometres (km) of submarine outfall with a diameter of 350 millimetres (mm) for the disposal of treated effluent from the STW

at San Shek Wan; (iv) construction of about 10.1 km of gravity sewers with diameters ranging from 150 mm to 375 mm along South Lantau Road and Chi Ma Wan road and at Pui O; and (v) construction of about 3.1 km twin rising mains with a diameter of 200 mm to 250 mm along South Lantau Road and Chi Ma Wan Road.

2.2.4. The performance of the environmental management system of the reporting period was generally satisfied. Mitigation measures according to the environmental mitigation implementation schedule and the EIA were generally implemented by the Contractor. Hence, the EM&A programme was considered effective and shall be maintained.

2.3 Works undertaken during the month

2.3.1. In the reporting month, the principal work activities conducted are as follow:

- Excavation, sewer laying, construction of manhole at Pui O Lo Uk Tsuen, South Lantau road, Pui O Beach
- Excavation and site formation at San Shek Wan Sewage Treatment Works (SSWSTW) and Pui O Sewage Pumping Station (POSPS)
- Horizontal Directional Drilling (HDD) works at marine
- Removal works of Excavation and Lateral Support (ELS)
- Excavation and Lateral Support (ELS) works
- Superstructure Reinforced Concrete (RC) Works

The locations of works are shown in [Figure 2.2](#).

2.4 Drawing showing the project area, environmental sensitive receivers and monitoring locations

2.4.1. Noise and water monitoring location plans with sensitive receivers are shown in [Figure 2.3](#) and [Figure 2.4](#).

3 Implementation Status

3.1 Advice on the implementation status of environmental protection and pollution control/mitigation measures

3.1.1. Mitigation measures according to the environmental mitigation implementation schedule in Annex A of EM&A Manual were generally implemented by the Contractor. Hence, the EM&A programme was considered effective and shall be maintained.

3.2 Environmental Mitigation Measures

3.2.1. Environmental mitigation measures mentioned the EIA Report were weekly reviewed and recorded in Weekly Environmental Site Audit Checklist. Also, a summary of the current status on submissions and measures mentioned in Environmental Permit (EP-538/2017) are shown in **Table 3.1**.

Table 3.1 Summary of submission status under EP-538/2017

EP Condition	Submission	Date of Latest Submission to EPD [^] / EPD Approval [#]
Condition 2.10	Waste Management Plan (Rev. 5) (electronic copy)	4 April 2022 [#]
Condition 2.11	Submission of Preservation and/or Transplantation Plan for Plant Species of Conservation Importance (Rev. 23)	9 September 2022 [#]
Condition 2.12	Submission of Compensatory Woodland Planting Plan (Rev. 23)	15 May 2023 [^]
Condition 2.13	Silt Curtain Deployment Plan (Rev. 11)	1 June 2022 [#]
Condition 2.14	Landscape Mitigation Plan	To be confirmed
Condition 2.15	Construction Noise Mitigation Plan (Rev. 20)	4 August 2022 [#]

3.3 Environmental monitoring requirements and contractual requirements

3.3.1. A summary of the current status on licences and/or permits on environmental protection pertinent to the Project is shown in **Table 3.2**.

Table 3.2 Summary of the current status on licences and/or permits on environmental protection pertinent to the Project

Permits and/or Licences	Permit. No. / Account No.	Issued Date	Valid Period & Expiry Date	Status
Notification of Works Under APCO	466408	14 Apr 2021	N/A	Valid
Wastewater Discharge Licence under <i>Water Pollution Control Ordinance</i>	SSWSTW: WT00039636-2021	30 Dec 2021	30-12-2021 to 31-12-2026	Valid
	POPS: WT00039820-2021	31 Dec 2021	31-12-2021 to 31-12-2026	Valid
	SSWSTW: Gravity Sewer & Raising Main: WT00042613-2022	09 Jan 2023	09-01-2023 to 31-01-2028	Valid
Billing account under Waste Disposal Ordinance	Account No.: 7040411	05 May 2021	N/A	Valid
Registration as a Chemical Waste Producer	0000-931-K3428-01	13 May 2021	N/A	Valid
Construction Noise Permit under Noise Control Ordinance for SSWSTW	GW-RS0065-24	30 Jan 2024	09-02-2024 to 08-08-2024	Valid
Construction Noise Permit under Noise Control Ordinance for POSPS	GW-RS0822-23	25 Sep 2023	27-09-2023 to 26-03-2024	Expired
	GW-RS0213-24	15 Mar 2024	27-03-2024 to 26-09-2024	Valid
Marine Dumping Permit (Dredged Sediment Requiring Type 1 – Open Sea Disposal)	EP/MD/24-060	27 Feb 2024	01-03-2024 to 31-08-2024	Valid

Note: Only include those valid or under application; fill in "N/A" for non-applicable item(s).

3.4 Site Inspection and Audit Reports

3.4.1. Within this reporting month, weekly environmental site inspections were conducted on **07, 12, 18 and 25 March 2024**. IEC attended the SSEMC meeting held on **18 February 2024**. Holding nursery visit for transplanted trees on **22 March 2024**.

3.4.2. **No** non-compliance was found during the site inspection while reminders on environmental measures were recommended. Results and findings of these inspections in this reporting month are listed below in **Table 3.3**.

Table 3.3 Summary of Environmental Inspections

Inspection Date	Reminder and Recommendations	Close-out Date / Status
7 March 2024	<u>Pui O Sewage Pumping Station(POSPS):</u> 1. Drip tray should be provided to chemical container	Rectified by the Contractor on 7 Mar 2024
12 March 2024	<u>Pui O Sewage Pumping Station(POSPS):</u> 1. Contractor was reminded to avoid surface runoff into public road.	N.A
18 March 2024	<u>Pui O Sewage Pumping Station(POSPS):</u> 1. Waste impervious sheet outside site boundary should be removed. 2. Housekeeping should be enhanced 3. Drip tray should be provided to chemical container	Rectified by the Contractor on 23 Mar 2024
25 March 2024	<u>Pui O Sewage Pumping Station(POSPS):</u> 1. Exposed soil outside at site boundary should be covered properly by tarpaulin sheet.	Rectified by the Contractor on 26 Mar 2024

4 Monitoring Results

4.1 Noise Monitoring

MONITORING METHODOLOGY

4.1.1 Monitoring Procedure

- (a) The impact noise monitoring should be carried out at all the designated monitoring stations when there are project-related construction activities undertaken within a radius of 300m from the monitoring stations.
- (b) The monitoring station shall normally be at a point 1m from the exterior of the sensitive receiver’s building façade and be at a position 1.2m above the ground.
- (c) Façade measurements were made at the monitoring locations. For free-field measurement, a correction factor of +3 dB (A) would be applied.
- (d) The battery condition was checked to ensure the correct functioning of the meter.
- (e) Parameters such as frequency weighting, the time weighting and the measurement time were set as follows:
- (f) Frequency weighting: A, Time weighting: Fast, Measurement time set: continuous 5 mins
- (g) Prior and after to the noise measurement, the meter was checked using the acoustic calibrator for 94dB (A) at 1000 Hz. If the difference in the calibration level before and after measurement was more than ± 1.0 dB (A), the measurement would be considered invalid and repeat of noise measurement would be required after re-calibration or repair of the equipment.
- (h) Noise measurements will be made in accordance with standard acoustical principles and shall not be made in fog, rain, wind with a steady speed exceeding 5m/s or wind with gusts exceeding 10m/s. The wind speed shall be checked with a portable wind speed meter capable of measuring the wind speed in m/s.

NAME OF LABORATORY AND EQUIPMENT USED AND CALIBRATION DETAILS

4.1.2 Noise monitoring was performed using sound level meter at the designated monitoring locations. The sound level meters shall comply with the International Electrotechnical Commission Publications 651:1979 (Type 1) and 804:1985 (Type 1) specifications. Acoustic calibrator shall be deployed to check the sound level meters at a known sound pressure level. Brand and model of the equipment is given in **Table 4.1**.

Table 4.1 Noise Monitoring Equipment

Equipment	Brand and Model	Series Number
Integrated Sound Level Meter	Larson Davis LxT1	0005062
Acoustic Calibrator	Larson Davis CAL200	13128

4.1.3 The calibration certificates of the noise monitoring equipment are attached in [Appendix 4.1](#).

4.1.4 Calibration Details

- (a) The microphone head of the sound level meter was cleaned with soft cloth at regular intervals.
- (b) The sound level meter and calibrator were calibrated at yearly intervals.

PARAMETERS MONITORED

4.1.5 The construction noise level shall be measured in terms of the A-weighted equivalent continuous sound pressure level (L_{eq}). $L_{eq(30min)}$ should be used as the monitoring parameter. Supplementary information for data auditing, statistical results such as L10 and L90 shall also be obtained for reference.

4.1.6 For impact monitoring for construction of village sewers / rising main, noise monitoring should be undertaken on weekly basis. One set of $L_{eq(30min)}$ noise level as six consecutive $L_{eq(5min)}$ between 07:00-19:00 hours on normal weekdays.

MONITORING STATIONS

4.1.7 The noise monitoring stations for the Project are listed and shown in **Table 4.2**, impact noise monitoring was conducted at **Eight (8)** noise monitoring stations N12a, N12b, N13, N14, N15b, N16a, N16b and N17 once per week in the reporting month.

Table 4.2 Noise Monitoring Station

Monitoring Station ID ⁽¹⁾	Monitoring Location	Measurement Type	Level (in terms of no. of floor)
N01a	Shui Hau Village	Free-Field	G/F
N01c	Shui Hau Village	Free-Field	G/F
N03a	Tong Fuk Village	Free-Field	G/F
N05a	Residences at Cheung Fu Street	Free-Field	G/F
N07	Government Holiday Bungalows	Free-Field	G/F
N08	Cheung Sha Ha Tsuen	Free-Field	G/F
N10	Cheung Sha Sheung Tsuen	Façade	G/F
N11b	San Shek Wan – Ming Garden	Free-Field	G/F
N12a	Lo Uk Tsuen	Free-Field	G/F
N12b	Lo Uk Tsuen	Façade	G/F
N13	Pui O San Wai Tsuen	Façade	G/F
N14	South Lantau Community Centre	Free-Field	G/F
N15b	Pui O Lo Wai Tsuen	Façade	G/F
N16a	Residences at Ham Tin	Free-Field	G/F

Monitoring Station ID ⁽¹⁾	Monitoring Location	Measurement Type	Level (in terms of no. of floor)
N16b	Residences at Ham Tin	Free-Field	G/F
N17	Bui O Public School	Façade	R/F

Remarks (1): Fine adjustment of noise monitoring stations at all locations was proposed as per EP Condition 3.1.

MONITORING DATE, TIME, FREQUENCY AND DURATION

4.1.8 For daytime construction work on normal weekdays, monitoring of $L_{eq(30min)}$ should be carried out at each station at 0700-1900 hours on normal weekdays at a frequency of once a week. Impact monitoring schedule can be referred to [Appendix 4.2](#).

NOISE MONITORING RESULTS

4.1.9 Noise monitoring results measured in this reporting period are reviewed and summarized. Details of noise monitoring results and graphical presentation can be referred in [Appendix 4.3](#).

4.1.10 School examination was taken place at N17 – Bui O Public School from 4 to 6 March 2024 in the reporting period, the limit level of noise monitoring station N17-Bui O Public School was adjusted accordingly to 65dB(A) during the period.

4.1.11 No action or limit level exceedance was recorded in construction noise level in this reporting period.

4.2 Water Quality Monitoring

MONITORING METHODOLOGY

4.2.1 Monitoring Procedure

- (a) The condition near the monitoring stations shall be observed and recorded on the data log sheet.
- (b) Check of sensors and electrodes with certified standard solutions before each use.
- (c) Wet bulb calibration for a DO meter should be carried out before measurement.
- (d) Water depth should be recorded by detector before sampling.
- (e) Sample would be taken using bucket sampler at surface level.
- (f) Transfer the sampled water carefully into cleaned water bottles (2x 1000ml) provided by the laboratory at the spot after the collection of the water sample for the subsequent laboratory Suspended Solid testing.
- (g) Transfer the sampled water from the bucket sampler to the rinsed water container for in-situ measurement (In case of the in-situ measurement cannot be carried at spot due to safety and adverse weather condition, sampled water from the bucket sampler will be transfer to cleaned water bottles provided by laboratory. Then, In-situ measurement will be conducted at a safe location which sampled water inside cleaned water bottle will be transfer to the rinsed water container for in-situ measurement) In-situ measurement shall be measured in duplicate.
- (h) Parameters including Water Temperature (°C), pH (units), Salinity (ppt), DO (mg/L), DO saturation (%) will be measured by the Multifunctional Meter and Turbidity (NTU) will be measured by turbid meter. (Water Temperature and Salinity will be measured as reference parameters)
- (i) Record the result on the data log sheet and record any special finding during / after in-situ measurement.
- (j) The water sample bottles will be stored in a cool box (at cooled to 4°C without being frozen), which shall be delivered to HOKLAS laboratory (ALS Technichem (HK) Pty Ltd) for further testing to determine the level of SS.

NAME OF LABORATORY AND EQUIPMENT USED AND CALIBRATION DETAILS

LABORATORY MEASUREMENT / ANALYSIS

- 4.2.2 Analysis of suspended solids will be carried out in a HOKLAS accredited laboratory, which is ALS Technichem (HK) Pty Ltd.

EQUIPMENT USED

Dissolved Oxygen, pH And Temperature Measuring Equipment

- 4.2.3 Multifunctional Meter and Turbid Meter are used at each designated monitoring station. They are capable of measuring:

- (a) a dissolved oxygen level in the range of 0-20mg/L and 0-200% saturation (Detection Limit: 0.1mg/L)
- (b) a temperature of 0-45 degree Celsius (Detection Limit: 0.1 degree Celsius)
- (c) turbidity level between 0-1000NTU (Detection Limit: 0.1NTU)
- (d) salinity in the range of 0-40ppt (Detection Limit: 0.1ppt)
- (e) pH value in range of 0.0 – 14.0 (Detection Limit: 0.1units)

Other monitoring equipment namely water depth meter, water current meter, dGPS positioning device, water sampler listed below were also deployed,

- (a) Water depth meter (Range: 0.6 -100m, Resolution: 0.1m)
- (b) Water current meter (Range: 0-360°, Detection Limit: 1mm/s)
- (c) dGPS positioning device (Resolution: Horizontal: 0.25m; Vertical: 0.50 m)
- (d) Water sampler (Horizontal discrete type, Capacity: 2.2L)

Sampler Container and Storage

4.2.4 A water sampler, Water samples for suspended solids measurement should be collected in high-density polythene bottles, packed in ice (cooled to 4°C without being frozen), and delivered to ALS Technichem (HK) Pty Ltd. as soon as possible after collection for analysis.

Water Depth Detector

4.2.5 A portable, battery-operated echo sounder shall be used for the determination of water depth at each designated monitoring station. This unit can either be handheld or affixed to the bottom of the workboat, if the same vessel is to be used throughout the monitoring programme.

CALIBRATION DETAILS

4.2.6 Maintenance and Calibration

- (a) The responses of sensors and electrodes of the water quality monitoring equipment were cleaned and checked at regular intervals.
- (b) DO meter (Multifunctional Meter) and turbid meter was certified by a laboratory accredited under HOKLAS or any other international accreditation scheme, and subsequently re-calibrated at three monthly intervals.

4.2.7 Brand and model of the equipment are given in **Table 4.3**.

Table 4.3 Water Quality Monitoring Equipment

Equipment	Brand and model	Series Number
Multifunctional Meter	YSI Professional Plus	16J104708/17F100236
Turbid meter	WGZ-3B	1807073

Calibration certificates of the water quality monitoring equipment are attached in [Appendix 4.1](#).

PARAMETERS MONITORED

4.2.8 In construction phase, the levels of dissolved oxygen (DO), temperature, turbidity and salinity should be measured in situ while suspended solids (SS) is determined by laboratory analysis.

MONITORING STATIONS

4.2.9 Water quality monitoring involves 9 monitoring stations. The locations of water quality monitoring station are shown in **Table 4.4**.

Table 4.4 Marine Water Quality Stations for Water Quality Monitoring

Station	Description	Easting	Northing
CE	Upstream control station at ebb tide	810838	807538
CF	Upstream control station at flood tide	815886	808081
SR4 ⁽¹⁾	Ecological Sensitive Receiver (Coral Communities) at Pui O Wan	814938	810975
SR5	Ecological Sensitive Receiver (Coral Communities) at Pui O Wan	814326	810540
SR6	Gazetted Bathing Beach at Lower Cheung Sha	810553	810475
SR9 ⁽¹⁾	Ecological Important Stream at Tong Fuk	811325	809787
SR10	Secondary Contact Recreational Zones at South Lantau	810561	809494
SR12 ⁽¹⁾	Proposed Special Site of Scientific Interest (SSSI) at Shui Hau Wan	810359	808989
SR15	Gazetted Bathing Beach at Pui O and Ecologically Important Stream at Pui O	816037	810722

Remarks (1): Fine adjustment of water quality monitoring stations at SR4, SR9 and SR12 was proposed as per EP Condition 3.1, and baseline monitoring was conducted at corresponding fine adjusted locations.

MONITORING DATE, TIME, FREQUENCY AND DURATION

4.2.10 Water quality monitoring had been commenced on 12 April 2022 the designated monitoring stations three days per week with respect to marine-based construction works commenced on 19 April 2022. HDD casing works commenced on 30 May 2022.

4.2.11 To support water quality monitoring, the silt curtain deployment plan has minor updates to include an additional brand of geosynthetic material as alternative for selection and adopt underwater robot for inspecting condition of silt curtain.

4.2.12 For the upcoming marine works (stage 3 and stage 4), new silt curtain extension to be applied at diffuser and emergency bypass constructions has been proposed and supplemented in the revised silt curtain deployment plan. Typical details of proposed silt curtain are shown in [Figure 2.7](#).

4.2.13 The levels of dissolved oxygen (DO), temperature, turbidity and salinity were measured in situ

- while suspended solids (SS) is determined by laboratory analysis at all the monitoring stations in **Table 4.4** three times a week. Impact monitoring schedule can be referred to [Appendix 4.2](#).
- 4.2.14 In association with the water quality parameters, other relevant data shall also be recorded, such as monitoring location / position, time, water temperature, DO saturation, weather conditions, and any special phenomena underway near the monitoring station.
- 4.2.15 Impact Monitoring shall be carried out three days per week, at mid-flood and mid-ebb tides (within ± 1.75 hour of the predicted time). The interval between two sets of monitoring shall not be less than 36 hours. The monitoring period should avoid concurrent marine project in the vicinity.
- 4.2.16 The sampling frequency of at least three days per week should be undertaken. Upon completion of the construction works, the monitoring exercise at the designated monitoring locations should be continued for four weeks in the same manner as the impact monitoring. In case exceedance of Action/Limit Level is recorded, the frequency shall be increased as per the Event and Action Plan.
- 4.2.17 To ensure the robustness of in-situ measurement, parameters shall be measured in duplicate. In case the difference between duplicates is larger than 25%, a third set of measurement shall be carried out.

MONITORING RESULTS

- 4.2.18 Marine water quality monitoring results measured in this reporting period are reviewed and summarized. Details of marine water quality monitoring results and graphical presentation can be referred in [Appendix 4.4](#)
- 4.2.19 [Water quality monitoring is evaluated against Action and Limit Levels. The derived Action and Limit Level proposed in Baseline Monitoring Report Rev. 9.2 was agreed by EPD on 2 September 2022. Action and Limit Levels of marine water quality monitoring have been set with reference to the derived criteria as shown in **Table 4.5** below for reference.](#)

Table 4.5 Action and Limit Levels of Water Quality

Parameters	Action Level	Limit Level
<i>Construction Phase Marine Water Monitoring - derived criteria</i>		
DO in mg/L ^B	Surface and Middle: 5.8 mg/L Bottom: 5.9 mg/L	Surface and Middle: 4 mg/L Bottom: 2 mg/L
Turbidity in NTU (Depth-averaged A) ^C	14.4 NTU <u>and</u> 20% exceedance of value at any impact station compared with corresponding data from control station ^D	23.5 NTU <u>and</u> 30% exceedance of value at any impact station compared with corresponding data from control station ^D
SS in mg/L (Depth-averaged A) ^C	13.1 mg/L <u>and</u> 20% exceedance of value at any impact station compared with corresponding data from control station ^D	30.4 mg/L <u>and</u> 30% exceedance of value at any impact station compared with corresponding data from control station ^D

Notes (with proposed amendments in AL/LL in underlined text):

A. "Depth-averaged" is calculated by taking the arithmetic means of reading of all three depths.

B. For DO, non-compliance of the water quality limits occurs when monitoring result is lower than the limits.

C. For SS and turbidity, non-compliance of the water quality limits occurs when monitoring result is higher than the limits.

D. Action Level and Limit Level with 95%-ile / 99%-ile derived from baseline data “and” 20% / 30% exceedance of control station proposed in Baseline Monitoring Report.

4.2.20 Number of exceedances recorded during the reporting month are summarized in **Table 4.6**.

Table 4.6 Summary of Marine Water Quality Exceedances

Station	Parameter	DO (S&M)		DO (Bottom)		Turbidity		SS		Exceedance count	
		Level exceeded	Mid Ebb	Mid Flood	Mid Ebb	Mid Flood	Mid Ebb	Mid Flood	Mid Ebb	Mid Flood	Mid Ebb
SR4	Action	/	/	/	/	/	/	/	/	0	0
	Limit	/	/	/	/	/	/	/	/	0	0
SR5	Action	/	/	/	/	/	/	/	/	0	0
	Limit	/	/	/	/	/	/	/	/	0	0
SR6	Action	/	/	/	/	/	/	/	/	0	0
	Limit	/	/	/	/	/	/	/	/	0	0
SR9	Action	/	/	/	/	/	/	/	/	0	0
	Limit	/	/	/	/	/	/	/	/	0	0
SR10	Action	/	/	/	/	/	/	/	/	0	0
	Limit	/	/	/	/	/	/	/	/	0	0
SR12	Action	/	/	/	/	/	/	/	/	0	0
	Limit	/	/	/	/	/	/	/	/	0	0
SR15	Action	/	/	/	/	/	/	/	/	0	0
	Limit	/	/	/	/	/	/	/	/	0	0
Total	Action	0	0	0	0	0	0	0	0	0	0
	Limit	0	0	0	0	0	0	0	0	0	0

4.2.21 Water quality monitoring on 9 (mid-ebb and mid-flood), 13 (mid-ebb) March 2024 were cancelled due to Strong Monsoon Signal. No substitution would be arranged for such cancellation since it is impossible to maintain the monitoring frequency as three times a week for the event of marine water quality monitoring cancellation in between time with respect to the fact that not less than 36 hours interval shall be followed for two monitoring days as required by the EM&A Manual Clause 5.1.6 (b) for the project.

4.2.22 In accordance with the action level and limit level in Baseline Monitoring Report Rev. 9.2 agreed by EPD on 2 September 2022, no action level and limit level exceedances were recorded in the reporting month.

4.3 Ecology

MONITORING METHODOLOGY

4.3.1 The weekly site audit to be carried out by the ET should include checking whether good site practices are being properly implemented by the Contractor.

4.3.2 Impact monitoring of the transplanted *Aquilaris sinensis* at holding nursery and one retain tree of *Aquilaris sinensis* in SSWSTW Project Site, establishment and after-establishment caring measures of the compensatory mixed woodland to ensure the affected tree would not be affected by any unacceptable construction works. The trees would be treated with establishment works immediately after transplanting.

PARAMETERS MONITORED

- 4.3.3 The extent of the work site boundaries should be checked by the ET during the weekly site audit. Any disturbance by the Contractor outside the works area especially any damage to the vegetation and surrounding habitats outside the Project area shall be reported to ER and IEC.
- 4.3.4 To identify any unacceptable construction works for the trees of *Aquilaris sinensis* during transplanting, establishment and after-establishment caring measures of the compensatory mixed woodland.

MONITORING LOCATION

- 4.3.5 As per latest version of PTP, four tree found (1 no. of *Aquilaria sinensis* and 3 nos. of *Gmelina chinensis*) within the site of SSWSTW ([Figure 2.5](#)) which are considered to be the plant species with conservative importance for temporarily transplanted to the nursery ([Figure 2.6](#)) at Kam Tin and eventually be transplanted to Pui O Pumping Station.

MONITORING DATE, TIME, FREQUENCY AND DURATION

- 4.3.6 The recommended good site practices to be audited once every week as part of the site audit programme. The weekly site audit to be carried out by the ET includes checking whether good site practices are being properly implemented by the Contractor. Results are recorded in Weekly Environmental Site Audit Checklist.
- 4.3.7 Monitoring programme for post-transplantation was conducted on [22 March 2024](#) once per month.

MONITORING RESULTS

- 4.3.8 The weekly site audit was carried out by ET include checking whether good site practices are being properly implemented by the Contractor.
- 4.3.9 The extent of the work site boundaries was checked by the ET during the weekly site audit.
- 4.3.10 Results and findings of site audit in this reporting month are listed in **Table 3.3**.

4.4 Waste Management

- 4.4.1 The quantities of waste for disposal in the Reporting Period are summarized in **Table 4.7**. The Monthly Summary Waste Flow Table is shown in [Appendix 4.5](#).

Table 4.7 Summary of Quantities of Waste Material



Waste Type	Quantity this month	Quantity (the end of last month)	Cumulative Quantity-to-Date
Hard Rock and Large Broken Concrete (Inert) (in '000m ³)	0	0	0
Reused in this Contract (Inert) (in '000m ³)	0	0	0
Reused in other Projects (Inert) (in '000m ³)	0	0	0
Disposal as Public Fill (Inert) (in '000m ³)	0.19468	0.17578	16.99626
Metals (in '000kg)	0.00530	8.15540	15.68900
Paper / Cardboard Packing (in '000kg)	0.04540	0.04180	0.67588
Plastics (in '000kg)	0.00170	0.00110	0.07006
Chemical Wastes (in '000kg)	0	0	0
General Refuses (in '000kg)	13.31	17.86	600.68
Marine Sediment (Type 1 – Open Sea Disposal) , m3	0	0	60.2

5 Complaints, Notification of Summons and Prosecution

5.1.1 No environmental complaint was recorded in the reporting month.

5.1.2 No notification of summons and successful prosecution regarding construction works were recorded in the reporting month.

5.1.3 Cumulative statistic on complaints, summary of complaints and successful prosecutions are summarized in **Table 5.1**, **Table 5.2** and **Table 5.3** respectively.

Table 5.1 Cumulative Statistics on Complaints

Reporting Period	No. of Complaints
March 2024	0
Project commencement to the end of last reporting month	2
Total	2

Table 5.2 Summary of Complaints

Date of Notification from EPD	Date of Complaint	Description of Complaint	Validity of Complaint	Close-Out Date / Status
26 May 2022	22 May 2022	A complaint is regarding noise nuisance from marine site of San Shek Wan, Lantau Island.	Based on the investigation, the works activities of marine works did not result in any noise nuisance to Noise Sensitive Receivers (NSRs), noise nuisance from the Project is unlikely to be valid.	The interim report was submitted to EPD in June 2022. EPD replied no further comments on the final investigation report on 13 July 2022.
23 Dec 2022	21 Dec 2022	A complaint is regarding to the water quality for Pui O Beach, Lantau Island.	Based on the investigation, the works activities at POPS did not result in any water quality impacts to the Pui O Beach.	The interim report was submitted to EPD on 4 Jan 2023.

Table 5.3 Cumulative Statistics on Successful Prosecutions

Environmental Parameters	Cumulative No. Brought Forward	No. of Successful Prosecutions this month (Offence Date)	Cumulative No. Project-to-Date
Air	-	0	0
Noise	-	0	0
Water	-	0	0
Waste	-	0	0
Other	-	0	0
Total	-	0	0

6 Future Key Issues

6.1.1 In coming reporting 3 months, the scheduled construction activities are listed as follows:

- Excavation, sewer laying, construction of manhole at Pui O Lo Uk Tsuen, South Lantau Road, Pui O Beach
- Dredging at marine
- Site formation works
- Drilling works
- Excavation works
- ELS works
- Superstructure RC Works
- Removal works of ELS

6.1.2 The scheduled construction activities and the recommended mitigation measures for the coming 3 months are listed in **Table 6.1**. The major construction activities for the next 3 months are summarized in Three Months Rolling Programme – April 2024 to June 2024 in [Appendix 6.1](#).

Table 6.1 Construction Activities and Recommended Mitigation Measures in Coming Reporting 3 Months

Key Construction Works	Recommended Mitigation Measures
<ul style="list-style-type: none"> • Excavation, sewer laying, construction of manhole at Pui O Lo Uk Tsuen, South Lantau Road, Pui O Beach • Dredging at marine • Site formation works • Drilling works • Excavation works • ELS works • Superstructure RC Works • Removal works of ELS 	<ul style="list-style-type: none"> • Implementation of noise pollution control in accordance with Construction Noise Mitigation Plan; • Dust control during dust generating works; • Silt curtain should be maintained in good condition; • Adopt surface drainage and sediment control facilities for sewage installation in village and public roads; • Adopt temporary drainage and sediment control facilities on Site; • Vehicle wheel-washing and body washing facilities should be provided at the site entrance; • Regular water spraying on excavation works for dust control; and • Proper waste handling, recycling and storage.

7 Conclusion

7.1 Noise Monitoring

7.1.1 School examination was taken place at N17 – Bui O Public School from 4 to 6 March 2024 in the reporting period, the limit level of noise monitoring station N17-Bui O Public School was adjusted accordingly to 65dB(A) during the period.

7.1.2 No action or limit level exceedance was recorded in construction noise level in this reporting period.

7.2 Water Quality Monitoring

7.2.1 Marine-based construction works commenced on 19 April 2022, HDD casing works commenced on 30 May 2022.

7.2.2 Water quality monitoring on 9 (mid-ebb and mid-flood), 13 (mid-ebb) March 2024 were cancelled due to Strong Monsoon Signal. No substitution would be arranged for such cancellation since it is impossible to maintain the monitoring frequency as three times a week for the event of marine water quality monitoring cancellation in between time with respect to the fact that not less than 36 hours interval shall be followed for two monitoring days as required by the EM&A Manual Clause 5.1.6 (b) for the project.

7.2.3 In accordance with the action level and limit level in Baseline Monitoring Report Rev. 9.2 agreed by EPD on 2 September 2022, no action level and limit level exceedances were recorded in the reporting month.

7.3 Ecological Impact Monitoring

7.3.1 Transplanting of the trees of *Aquilaris sinensis* was completed on 26 April 2022. Maintenance works for trees in holding nursery have commenced.

7.3.2 As per latest version of PTP, four tree found (1 no. of *Aquilaria sinensis* and 3 nos. of *Gmelina chinensis*) within the site of SSWSTW which are considered to be the plant species with conservative importance for temporarily transplanted to the nursery at Kam Tin and eventually be transplanted to Pui O Pumping Station.

7.3.3 The weekly site audit was carried out by ET include checking whether good site practices are being properly implemented by the Contractor.

7.3.4 The extent of the work site boundaries was checked by the ET during the weekly site audit.

7.3.5 Within this reporting period, holding nursery visit for transplanted trees on 22 March 2024.

7.3.6 No non-compliance was found during the site inspection while reminders on environmental measures were recommended. Results and findings of these inspections in this reporting period are listed below in **Table 7.1**.

Table 7.1 Summary of Ecological Impact Monitoring

Inspection Date	Reminder and Recommendations	Close-out Date / Status
22 March 2024	<p>Transplanted trees in holding nursery at Kam Tin Remainder:</p> <ol style="list-style-type: none"> The Contractor was reminded to provide watering to all tree species temporarily transplanted in the holding nursery. 	Will be rectified in early April 2024

Note: Previous finding during site inspection on 28 Feb 2024 was rectified on 8 March 2024.

7.4 Review of the Reasons for and the Implications of Non-compliance

7.4.1 No environmental non-compliance was recorded in the reporting month.

7.5 Summary of action taken in the event of and follow-up on non-compliance

7.5.1 There was no particular action taken since no non-compliance was recorded in the reporting period.



Figure 2.1

Master Layout Plan

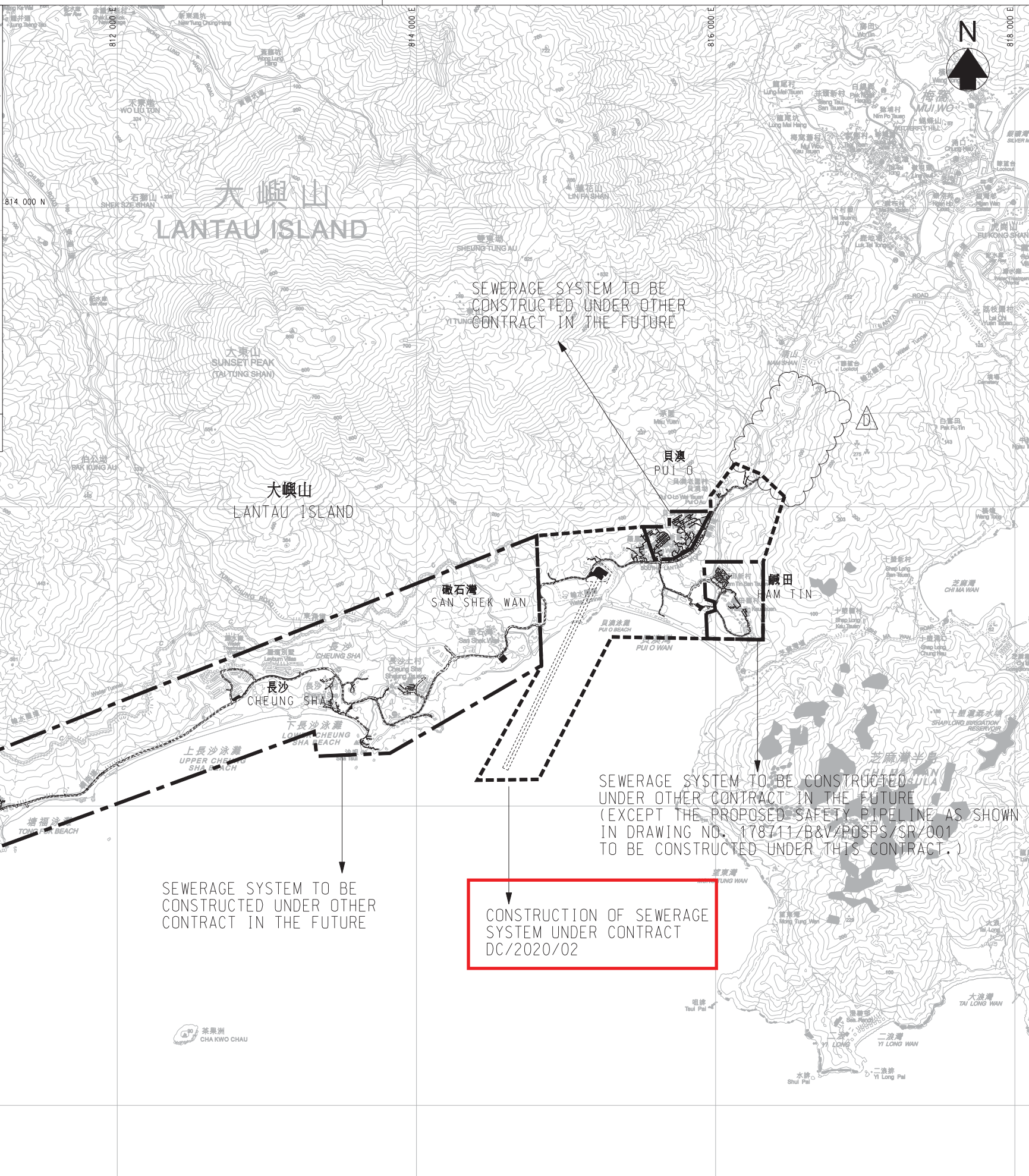
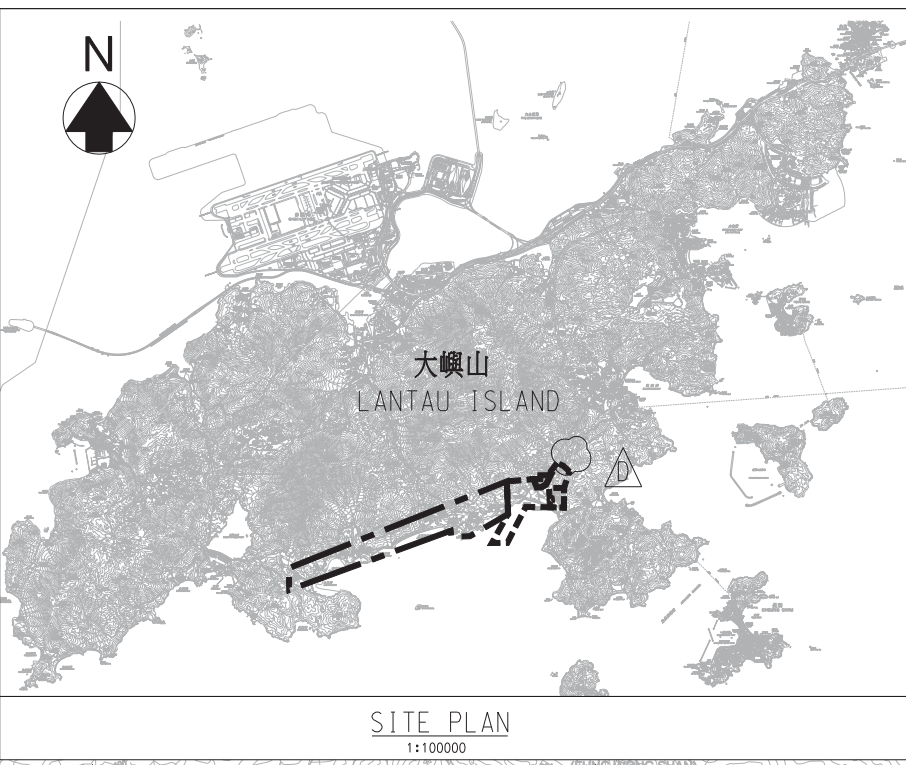

Revision	Date	Description	Initial
D	11/20	TENDER ADDENDUM NO.6	BL
C	11/20	TENDER ADDENDUM NO.5	BL
B	11/20	TENDER ADDENDUM NO.4	BL
A	09/20	TENDER ADDENDUM NO.2	TFL
Designed	Checked	Drawn	Checked
Initial	TFL	BL	SZ
Date	04/20	04/20	04/20

Approved: *Christina*

Contract no. DC/2020/02

Contract title
CONSTRUCTION OF SAN SHEK WAN SEWAGE TREATMENT WORKS, ASSOCIATED SUBMARINE OUTFALL AND PUI O SEWERAGE WORKS

Drawing title
SOUTH LANTAU SEWERAGE WORKS - MASTER LAYOUT PLAN

Drawing no. 178711/B&V/GN/001
Revision D

Scale 1 : 15000



BLACK & VEATCH HONG KONG LIMITED
博威工程顧問有限公司

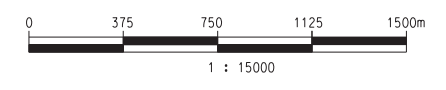
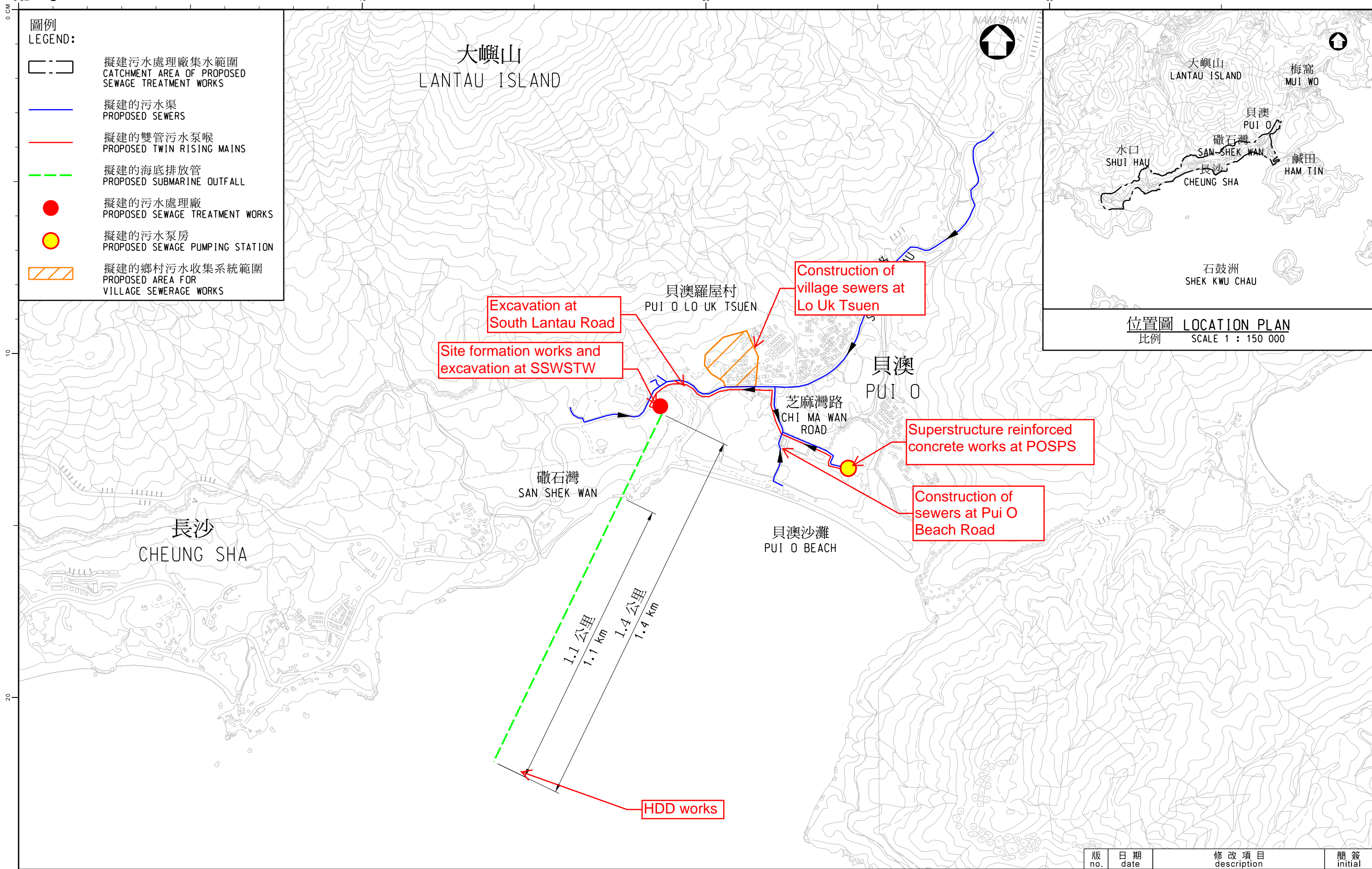



Figure 2.2
Contract Layout Plan

Figure 2.2



圖則名稱 drawing title
 工務工程計劃編號331DS - 離島污水收集系統第2階段
 - 南大嶼山污水收集系統工程
 PWP ITEM NO.331DS - OUTLYING ISLANDS SEWERAGE, STAGE 2
 - SOUTH LANTAU SEWERAGE WORKS

繪畫 drawn	SIGNED W. H. CHAN	日期 date	27 APR 2020
核對 checked	SIGNED Ir K. S. CHAN	日期 date	27 APR 2020
批核 approved	SIGNED Ir L. CHEN	日期 date	27 APR 2020
部門 office	特別職務部 SPECIAL DUTY DIVISION		







版 no.	日期 date	修改項目 description	簡簽 initial
圖則編號 drawing no.		比例 scale	
DVD/2020/001		1:12 500	
保留版權 COPYRIGHT RESERVED			
香港特別行政區政府渠務署 DRAINAGE SERVICES DEPARTMENT GOVERNMENT OF THE HONG KONG SPECIAL ADMINISTRATIVE REGION			





Figure 2.3

Locations of Noise Monitoring Station

圖例 LEGEND:

-  擬建污水處理廠集水範圍
CATCHMENT AREA OF PROPOSED SEWAGE TREATMENT WORKS
-  擬建的污水渠
PROPOSED SEWERS
-  擬建的雙管污水泵喉
PROPOSED TWIN RISING MAINS
-  擬建的海底排放管
PROPOSED SUBMARINE OUTFALL
-  擬建的污水處理廠
PROPOSED SEWAGE TREATMENT WORKS
-  擬建的污水泵房
PROPOSED SEWAGE PUMPING STATION
-  擬建的鄉村污水收集系統範圍
PROPOSED AREA FOR VILLAGE SEWERAGE WORKS

-  FINE ADJUSTED NOISE MONITORING LOCATIONS
-  AREA OF A RADIUS OF 300m OFFSET FROM CONSTRUCTION AREA
-  AREA OF A RADIUS OF 300m OFFSET FROM CONSTRUCTION AREA FOR VILLAGE SEWERAGE WORKS

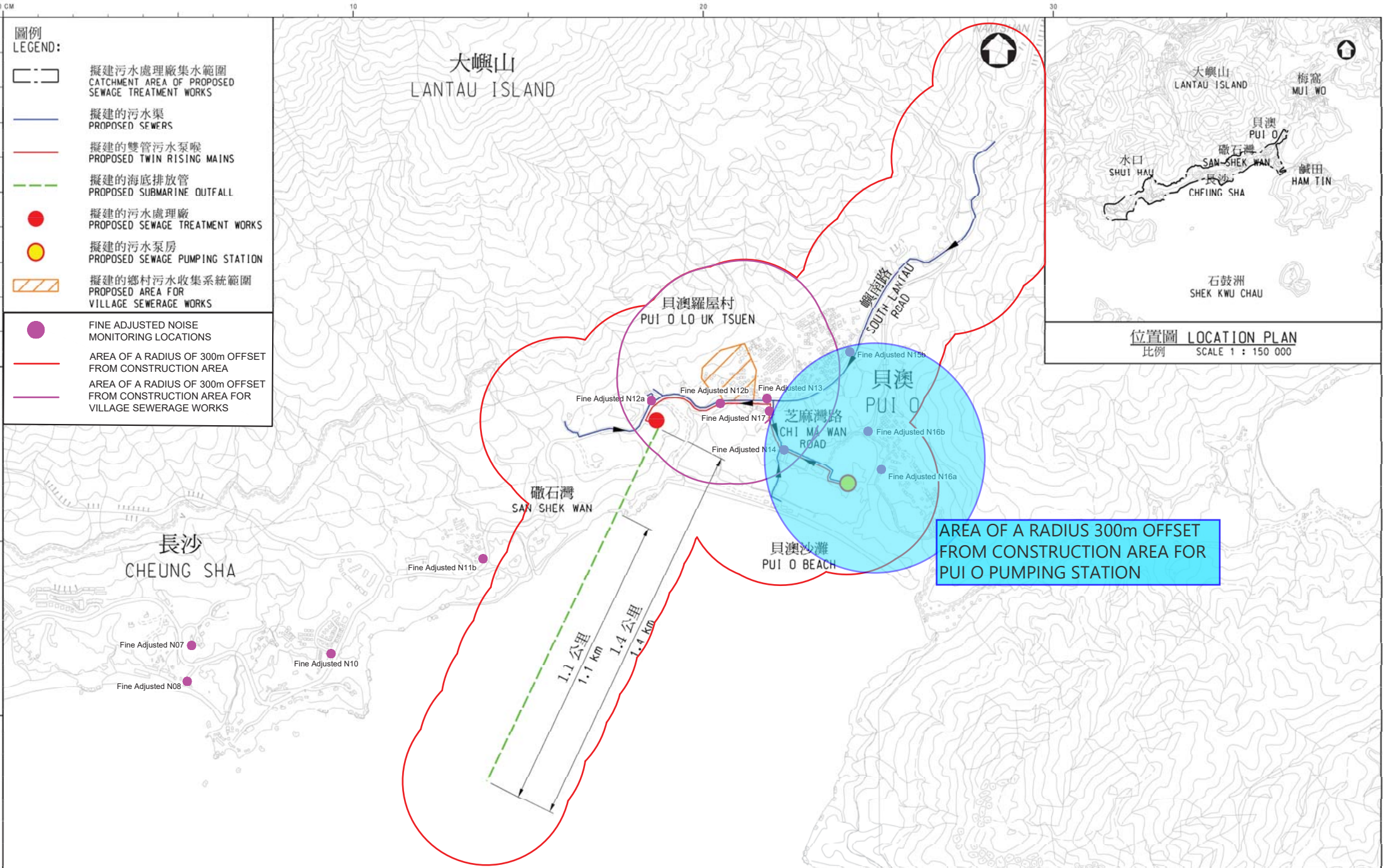
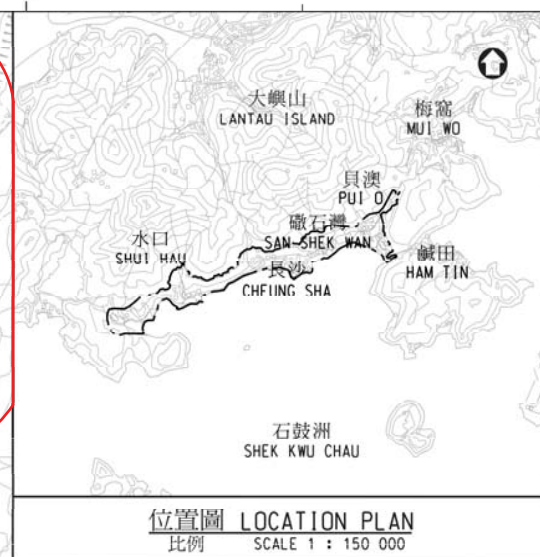

AREA OF A RADIUS 300m OFFSET FROM CONSTRUCTION AREA FOR PUI O PUMPING STATION



Figure 2.4

Locations of Water Quality Monitoring Stations

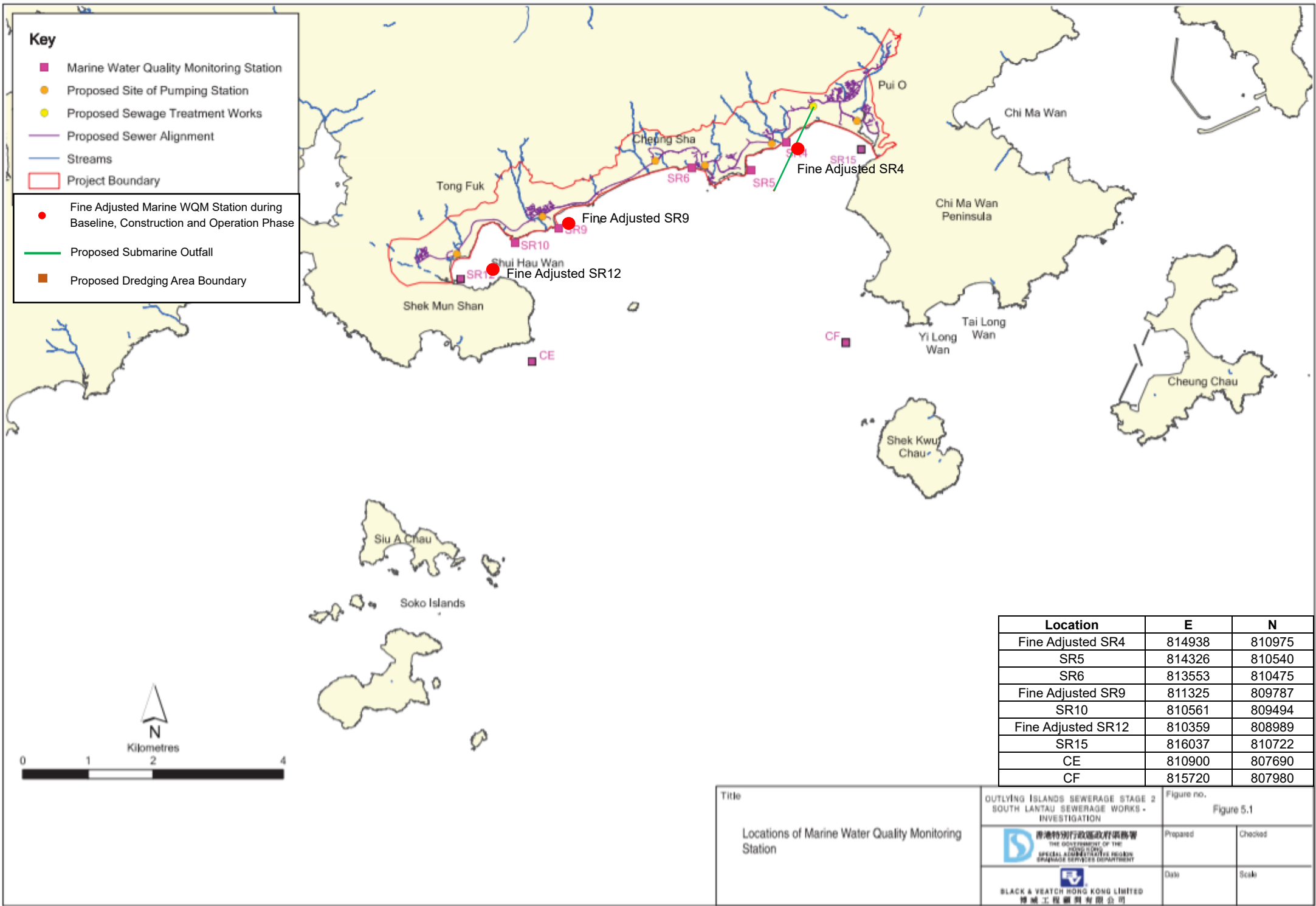

Key

- Marine Water Quality Monitoring Station
- Proposed Site of Pumping Station
- Proposed Sewage Treatment Works
- Proposed Sewer Alignment
- Streams
- Project Boundary
- Fine Adjusted Marine WQM Station during Baseline, Construction and Operation Phase
- Proposed Submarine Outfall
- Proposed Dredging Area Boundary

Location	E	N
Fine Adjusted SR4	814938	810975
SR5	814326	810540
SR6	813553	810475
Fine Adjusted SR9	811325	809787
SR10	810561	809494
Fine Adjusted SR12	810359	808989
SR15	816037	810722
CE	810900	807690
CF	815720	807980

Title Locations of Marine Water Quality Monitoring Station	OUTLYING ISLANDS SEWERAGE STAGE 2 SOUTH LANTAU SEWERAGE WORKS - INVESTIGATION		Figure no. Figure 5.1	
			Prepared	Checked
			Date	Scale



Figure 2.5

Mark up Figure 5.4i extracted from approved EIA Report (AEIAR-210/2017)

Figure 2.5 - Mark up Figure 5.4i extracted from approved EIA Report (AEIAR-210/2017)

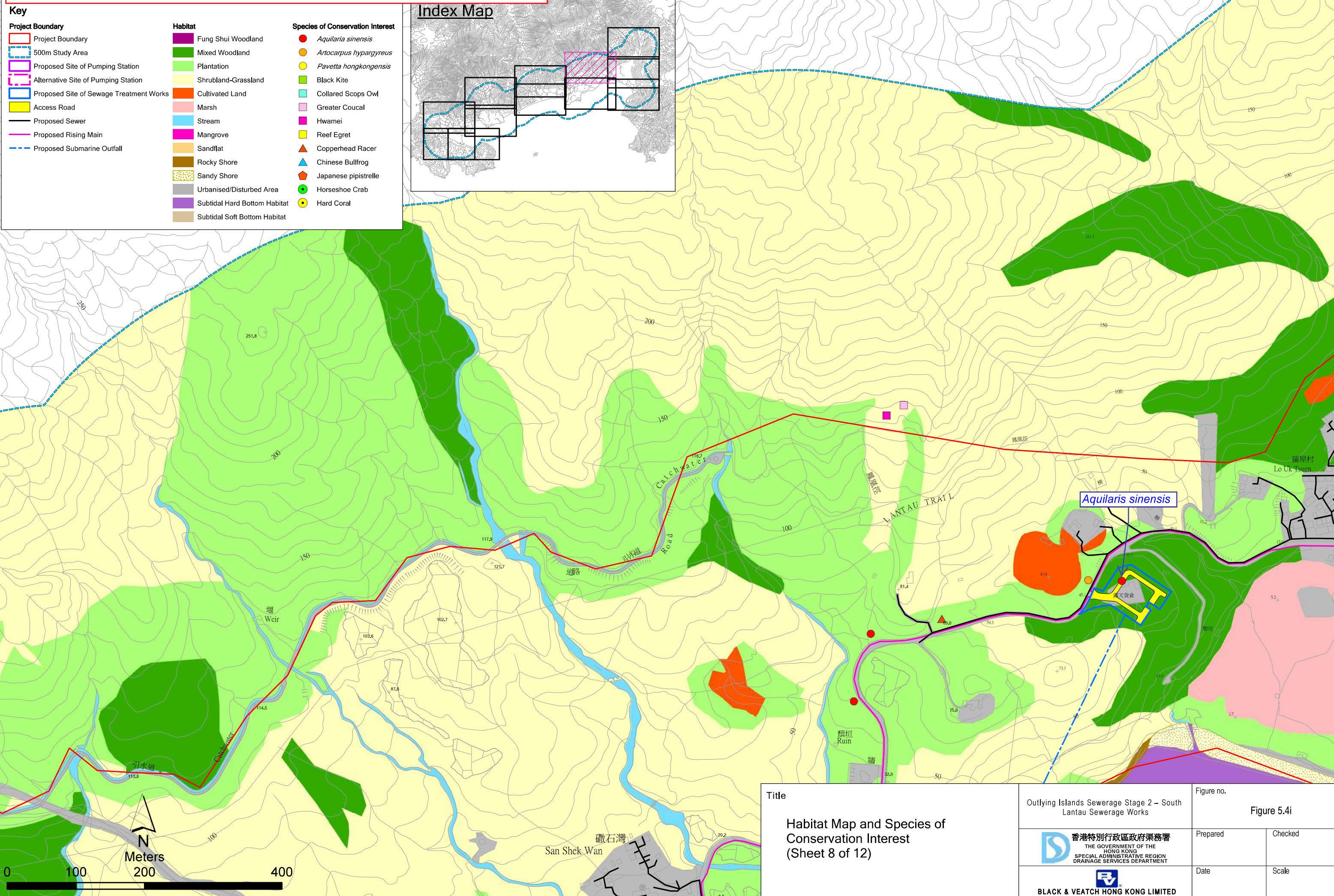

- Key**
- Project Boundary**
- Project Boundary
 - 500m Study Area
 - Proposed Site of Pumping Station
 - Alternative Site of Pumping Station
 - Proposed Site of Sewage Treatment Works
 - Access Road
 - Proposed Sewer
 - Proposed Rising Main
 - Proposed Submarine Outfall
- Habitat**
- Fung Shui Woodland
 - Mixed Woodland
 - Plantation
 - Shrubland-Grassland
 - Cultivated Land
 - Marsh
 - Stream
 - Mangrove
 - Sandflat
 - Rocky Shore
 - Sandy Shore
 - Urbanised/Disturbed Area
 - Subtidal Hard Bottom Habitat
 - Subtidal Soft Bottom Habitat
- Species of Conservation Interest**
- Aquilaria sinensis*
 - Artocarpus hypargyreus*
 - Pavetta hongkongensis*
 - Black Kite
 - Collared Scops Owl
 - Greater Coucal
 - Hwamei
 - Reef Egret
 - Copperhead Racer
 - Chinese Bullfrog
 - Japanese pipistrelle
 - Horseshoe Crab
 - Hard Coral

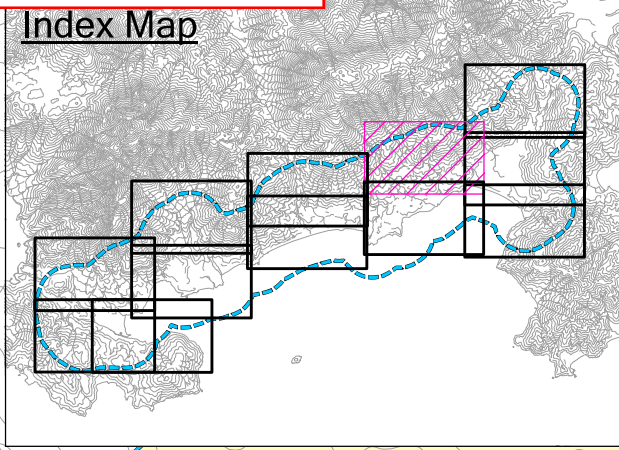

<p>Title</p> <p>Habitat Map and Species of Conservation Interest (Sheet 8 of 12)</p>	<p>Outlying Islands Sewerage Stage 2 – South Lantau Sewerage Works</p>		Figure no.	Figure 5.4i
	<p>香港特別行政區政府渠務署 THE GOVERNMENT OF THE HONG KONG SPECIAL ADMINISTRATIVE REGION DRAINAGE SERVICES DEPARTMENT</p>		Prepared	Checked
	<p>BLACK & VEATCH HONG KONG LIMITED</p>		Date	Scale

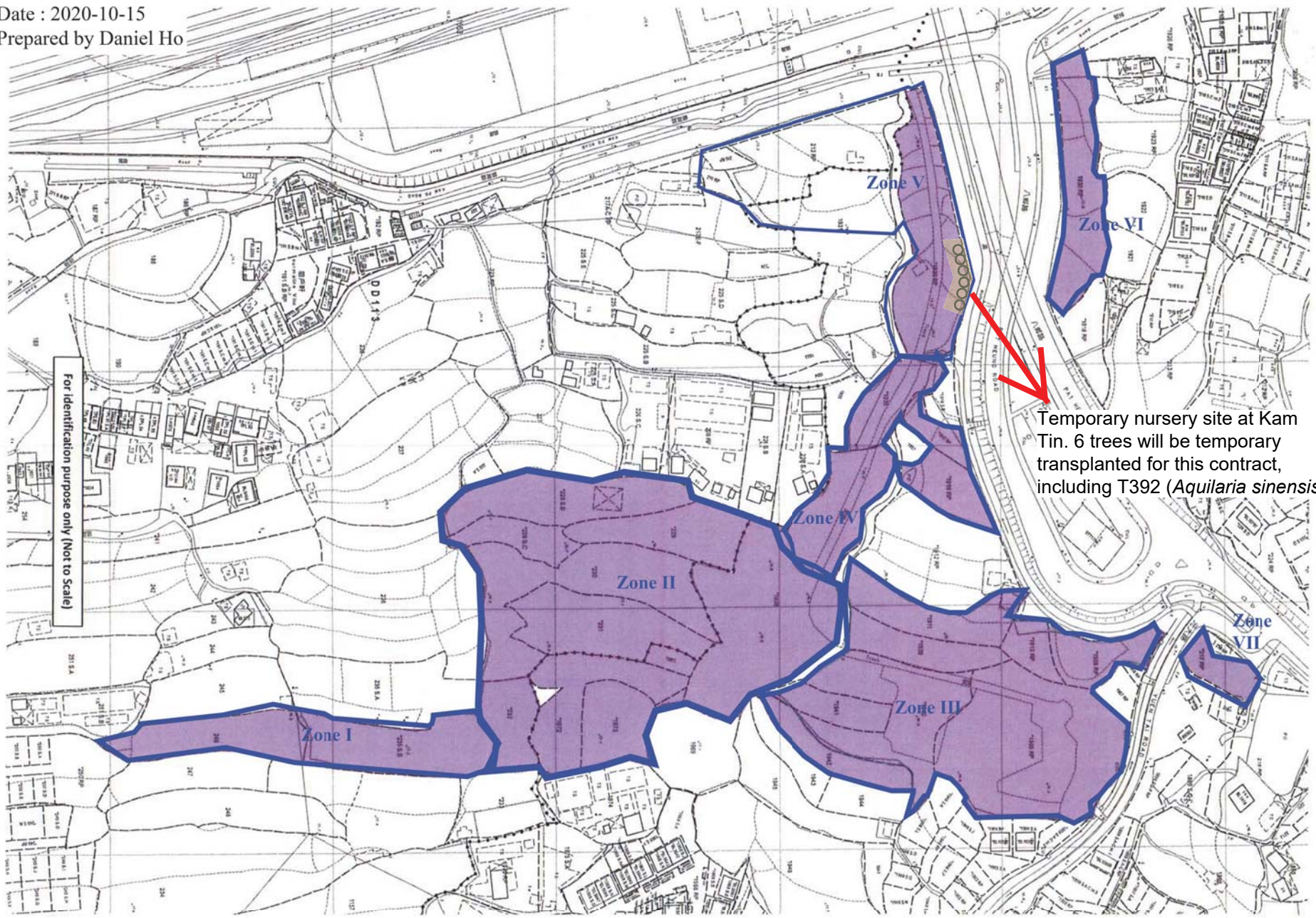

Figure 2.6

Location Plan for Temporary Holding Nursery

Figure 2.6

Date : 2020-10-15
Prepared by Daniel Ho



COPY RIGHT®

Project : Contract No.: DC/2020/02
Construction of San Shek Wan Sewage Treatment Works,
Associated Submarine Outfall and Pui O Sewerage Works

 **Toyo Greenland Co., Ltd.**

Drawing Title : Location Plan for 6 nos. Trees on Kam Tin Nursery

Check : Ho Tat Pui, Daniel

Scale : N.T.S.

Rev.

Ref: C3109/22/TGD0164

Date : 10 January 2022

00

Figure 2.7

Typical Details of Proposed Silt Curtain

Stage 1 & Stage 2

Marine supporting platform & HDD works

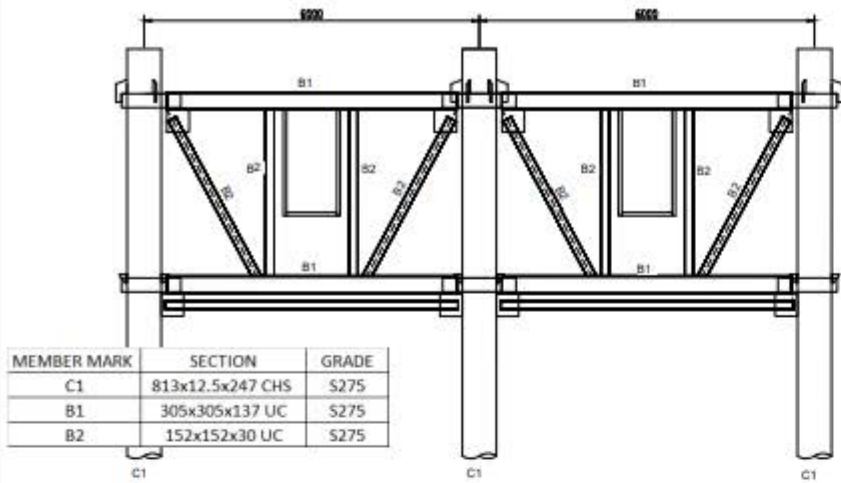

MEMBER MARK	SECTION	GRADE
C1	813x12.5x247 CHS	S275
B1	305x305x137 UC	S275
B2	152x152x30 UC	S275

SECTION B-B
SCALE 1:50

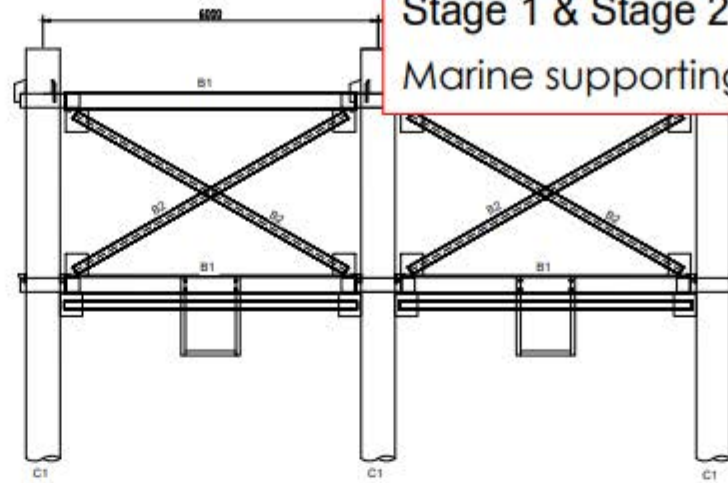

SECTION C-C
SCALE 1:50

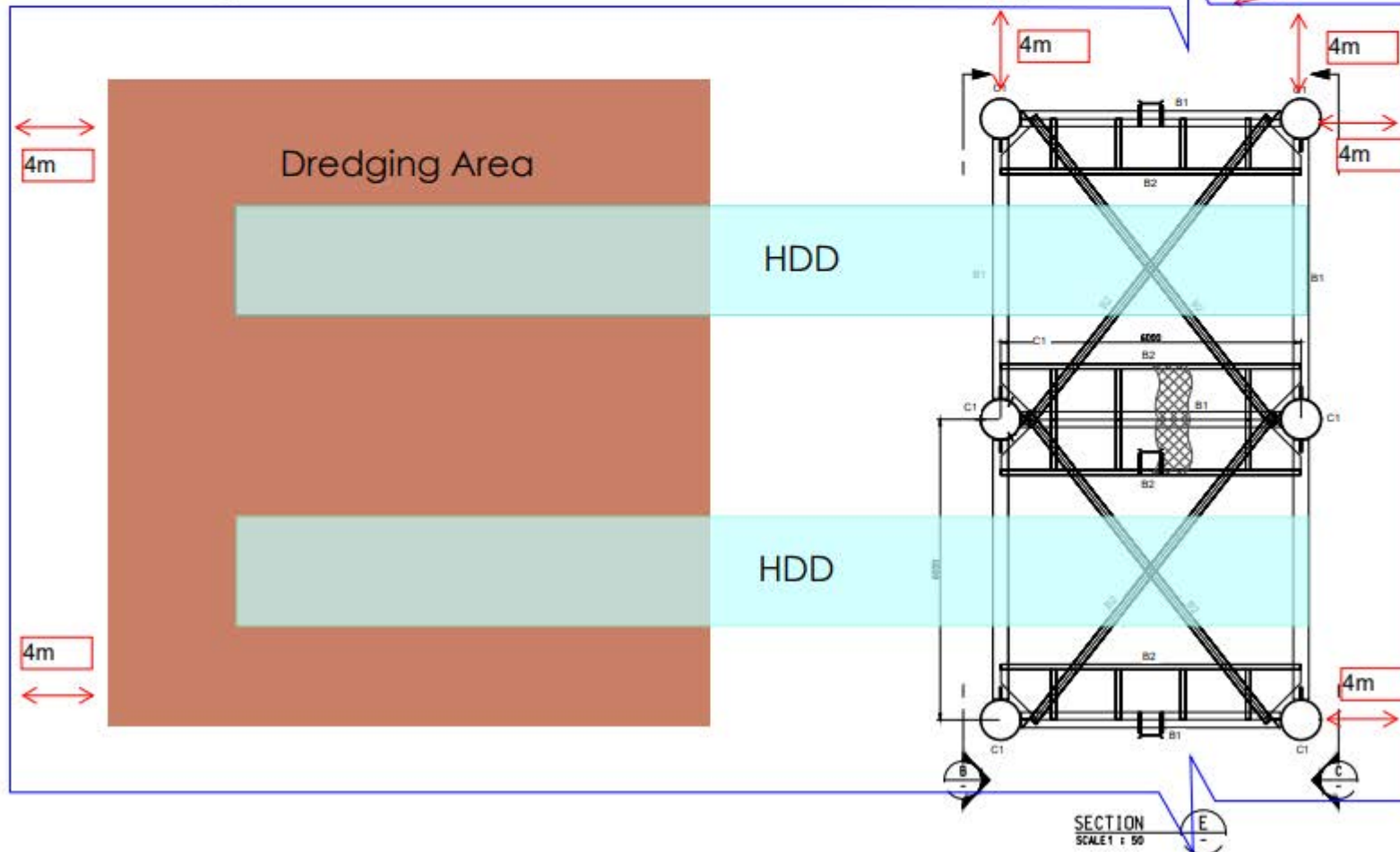

Silt curtain extent

Rev.	Description	By	Date

Project Manager's Representative

 Contractor
 群利-俊和聯營體

 Supported by

 Member of the STV Lend Lease Group

Project title
 Contract No. DC/2020/02
 CONSTRUCTION OF SAN SHEK WAN SEWAGE TREATMENT WORKS, ASSOCIATED SUBMARINE OUTFALL AND PUI O SEWERAGE WORKS

Drawing title
 DETAILS OF HDD TEMPORARY STEEL SCAFFOLD (SEA SIDE)

Drawing no. CJ2103DC1-SK-001 Rev. 001
 Drawn By JC Checked By FT Approved By JC
 Scale 1:50 Status

Printed by Jimmy Cheung, Binnie Group, October 15, 2020, 04:02:27 PM.
 File name: \\03_0000_Projects\DC1-SK\BIBS\1 - HDD Temporary Steel Scaffold\03_Drawing\03_000001-01.dwg



Appendix 4.1

Copies of Calibration Certificates



CERTIFICATE OF CALIBRATION

Certificate No.: 23CA0508 02-04

Page 1 of 2

Item tested

Description:	Sound Level Meter (Class 1)	Microphone	Preamp
Manufacturer:	Larson Davis	PCB	PCB
Type/Model No.:	LxT1	377B02	PRMLxT1L
Serial/Equipment No.:	0005062	173734	042836
Adaptors used:	-	-	-

Item submitted by

Customer Name:	Lam Environmental Services Limited
Address of Customer:	-
Request No.:	-
Date of receipt:	08-May-2023

Date of test: 11-May-2023

Reference equipment used in the calibration

Description:	Model:	Serial No.	Expiry Date:	Traceable to:
Multi function sound calibrator	B&K 4226	2288444	23-Aug-2023	CIGISMEC
Signal generator	DS 360	61227	08-Jun-2023	CEPREI

Ambient conditions

Temperature:	22 ± 1 °C
Relative humidity:	55 ± 10 %
Air pressure:	1005 ± 5 hPa

Test specifications

- 1, The Sound Level Meter has been calibrated in accordance with the requirements as specified in BS 7580: Part 1: 1997 and the lab calibration procedure SMTP004-CA-152.
- 2, The electrical tests were performed using an electrical signal substituted for the microphone which was removed and replaced by an equivalent capacitance within a tolerance of ±20%.
- 3, The acoustic calibration was performed using an B&K 4226 sound calibrator and corrections was applied for the difference between the free-field and pressure responses of the Sound Level Meter.

Test results

This is to certify that the Sound Level Meter conforms to BS 7580: Part 1: 1997 for the conditions under which the test was performed.

Details of the performed measurements are presented on page 2 of this certificate.

Actual Measurement data are documented on worksheets.

Approved Signatory:

Feng Junqi

Date: 13-May-2023

Company Chop:



Comments: The results reported in this certificate refer to the condition of the instrument on the date of calibration and carry no implication regarding the long-term stability of the instrument. The results apply to the item as received.



CERTIFICATE OF CALIBRATION

(Continuation Page)

Certificate No.: 23CA0508 02-04 Page 2 of 2

1, Electrical Tests

The electrical tests were performed using an equivalent capacitance substituted for the microphone. The results are given in below with test status and the estimated uncertainties. The "Pass" means the result of the test is inside the tolerances stated in the test specifications. The "-" means the result of test is outside these tolerances.

Test:	Subtest:	Status:	Expanded Uncertainty (dB)	Coverage Factor
Self-generated noise	A	Pass	0.3	
	C	Pass	0.8	2.1
	Lin	Pass	1.6	2.2
Linearity range for Leq	At reference range, Step 5 dB at 4 kHz	Pass	0.3	
	Reference SPL on all other ranges	Pass	0.3	
	2 dB below upper limit of each range	Pass	0.3	
	2 dB above lower limit of each range	Pass	0.3	
Linearity range for SPL	At reference range, Step 5 dB at 4 kHz	Pass	0.3	
	A	Pass	0.3	
	C	Pass	0.3	
	Lin	Pass	0.3	
Time weightings	Single Burst Fast	Pass	0.3	
	Single Burst Slow	Pass	0.3	
Peak response	Single 100µs rectangular pulse	Pass	0.3	
R.M.S. accuracy	Crest factor of 3	Pass	0.3	
Time weighting I	Single burst 5 ms at 2000 Hz	Pass	0.3	
	Repeated at frequency of 100 Hz	Pass	0.3	
Time averaging	1 ms burst duty factor 1/10 ³ at 4kHz	Pass	0.3	
	1 ms burst duty factor 1/10 ⁴ at 4kHz	Pass	0.3	
Pulse range	Single burst 10 ms at 4 kHz	Pass	0.4	
Sound exposure level	Single burst 10 ms at 4 kHz	Pass	0.4	
Overload indication	SPL	Pass	0.3	
	Leq	Pass	0.4	

2, Acoustic tests

The complete sound level meter was calibrated on the reference range using a B&K 4226 acoustic calibrator with 1000Hz and SPL 94 dB. The sensitivity of the sound level meter was adjusted. The test result at 125 Hz and 8000 Hz are given in below with test status and the estimated uncertainties.

Test:	Subtest	Status	Expanded Uncertainty (dB)	Coverage Factor
Acoustic response	Weighting A at 125 Hz	Pass	0.3	
	Weighting A at 8000 Hz	Pass	0.5	

3, Response to associated sound calibrator

N/A

The expanded uncertainties have been calculated in accordance with the ISO Publication "Guide to the expression of uncertainty in measurement", and gives an interval estimated to have a level of confidence of 95%. A coverage factor of 2 is assumed unless explicitly stated.

Calibrated by:

Date:

Fung Chi Yip
11-May-2023

- End -

Checked by:

Date:

Chan Yuk Yiu
13-May-2023

The standard(s) and equipment used in the calibration are traceable to national or international recognised standards and are calibrated on a schedule to maintain the required accuracy level.



Test Data for Sound Level Meter

Page 1 of 5

Sound level meter type:	LxT1	Serial No.	0005062	Date	11-May-2023
Microphone type:	377B02	Serial No.	173734		
Preamp type:	PRMLxT1L	Serial No.	042836	Report:	23CA0508 02-04

SELF GENERATED NOISE TEST

The noise test is performed in the most sensitive range of the SLM with the microphone replaced by an equivalent impedance.

Noise level in A weighting	8.5	dB
Noise level in C weighting	12.5	dB
Noise level in Lin	19.5	dB

LINEARITY TEST

The linearity is tested relative to the reference sound pressure level using a continuous sinusoidal signal of frequency 4 kHz. The measurement is made on the reference range for indications at 5 dB intervals starting from the 94 dB reference sound pressure level. And until within 5 dB of the upper and lower limits of the reference range, the measurements shall be made at 1 dB intervals. (SLM set to LEQ/SPL)

Reference/Expected level	Actual level		Tolerance	Deviation	
	non-integrated	integrated		non-integrated	integrated
dB	dB	dB	+/- dB	dB	dB
94.0	94.0	94.0	0.7	0.0	0.0
99.0	99.0	99.0	0.7	0.0	0.0
104.0	104.0	104.0	0.7	0.0	0.0
109.0	109.0	109.0	0.7	0.0	0.0
114.0	114.0	114.0	0.7	0.0	0.0
115.0	115.0	115.0	0.7	0.0	0.0
116.0	116.0	116.0	0.7	0.0	0.0
117.0	117.0	117.0	0.7	0.0	0.0
118.0	118.0	118.0	0.7	0.0	0.0
119.0	118.9	118.9	0.7	-0.1	-0.1
120.0	120.0	120.0	0.7	0.0	0.0
89.0	89.0	89.0	0.7	0.0	0.0
84.0	84.0	84.0	0.7	0.0	0.0
79.0	79.0	79.0	0.7	0.0	0.0
74.0	74.0	74.0	0.7	0.0	0.0
69.0	69.0	69.0	0.7	0.0	0.0
64.0	64.0	64.0	0.7	0.0	0.0
59.0	59.0	59.0	0.7	0.0	0.0
54.0	54.0	54.0	0.7	0.0	0.0
49.0	49.0	49.0	0.7	0.0	0.0
44.0	44.0	44.0	0.7	0.0	0.0
39.0	38.9	38.9	0.7	-0.1	-0.1
34.0	33.9	33.9	0.7	-0.1	-0.1
33.0	32.9	32.9	0.7	-0.1	-0.1



Test Data for Sound Level Meter

Page 2 of 5

Sound level meter type: LxT1 Serial No. 0005062 Date 11-May-2023
Microphone type: 377B02 Serial No. 173734
Preamp type: PRMLxT1L Serial No. 042836 Report: 23CA0508 02-04

32.0	31.9	31.9	0.7	-0.1	-0.1
31.0	30.9	30.9	0.7	-0.1	-0.1
30.0	29.8	29.9	0.7	-0.2	-0.1

Measurements for an indication of the reference SPL on all other ranges which include it

Other ranges	Expected level	Actual level	Tolerance	Deviation
dB	dB	dB	+/- dB	dB
20-120	94.0	94.0	0.7	0.0

Measurements on all level ranges for indications 2 dB below the upper limit and 2 dB above the lower limit

Ranges	Reference/Expected level	Actual level	Tolerance	Deviation
dB	dB	dB	+/- dB	dB
20-120	30.0	29.9	0.7	-0.1
	118.0	118.0	0.7	0.0

FREQUENCY WEIGHTING TEST

The frequency response of the weighting networks are tested at octave intervals over the frequency ranges 31.5 Hz to 12500 Hz. The signal level at 1000 Hz is set to give an indication of the reference SPL.

Frequency weighting A:

Frequency	Ref. level	Expected level	Actual level	Tolerance(dB)		Deviation
				+	-	
Hz	dB	dB	dB			dB
1000.0	94.0	94.0	94.0	0.0	0.0	0.0
31.6	94.0	54.6	54.6	1.5	1.5	0.0
63.1	94.0	67.8	67.8	1.5	1.5	0.0
125.9	94.0	77.9	77.9	1.0	1.0	0.0
251.2	94.0	85.4	85.4	1.0	1.0	0.0
501.2	94.0	90.8	90.7	1.0	1.0	-0.1
1995.0	94.0	95.2	95.2	1.0	1.0	0.0
3981.0	94.0	95.0	95.0	1.0	1.0	0.0
7943.0	94.0	92.9	92.9	1.5	3.0	0.0
12590.0	94.0	89.7	89.7	3.0	6.0	0.0

Frequency weighting C:

Frequency	Ref. level	Expected level	Actual level	Tolerance(dB)		Deviation
				+	-	
Hz	dB	dB	dB			dB
1000.0	94.0	94.0	94.0	0.0	0.0	0.0
31.6	94.0	91.0	91.0	1.5	1.5	0.0
63.1	94.0	93.2	93.1	1.5	1.5	-0.1
125.9	94.0	93.8	93.8	1.0	1.0	0.0
251.2	94.0	94.0	94.0	1.0	1.0	0.0
501.2	94.0	94.0	94.0	1.0	1.0	0.0



Test Data for Sound Level Meter

Page 3 of 5

Sound level meter type: LXT1 Serial No. 0005062 Date 11-May-2023
Microphone type: 377B02 Serial No. 173734
Preamp type: PRMLxT1L Serial No. 042836 Report: 23CA0508 02-04

1995.0	94.0	93.8	93.8	1.0	1.0	0.0
3981.0	94.0	93.2	93.2	1.0	1.0	0.0
7943.0	94.0	91.0	91.0	1.5	3.0	0.0
12590.0	94.0	87.8	87.7	3.0	6.0	-0.1

Frequency weighting Lin:

Frequency Hz	Ref. level dB	Expected level dB	Actual level dB	Tolerance(dB)		Deviation dB
				+	-	
1000.0	94.0	94.0	94.0	0.0	0.0	0.0
31.6	94.0	94.0	94.0	1.5	1.5	0.0
63.1	94.0	94.0	93.9	1.5	1.5	-0.1
125.9	94.0	94.0	94.0	1.0	1.0	0.0
251.2	94.0	94.0	94.0	1.0	1.0	0.0
501.2	94.0	94.0	94.0	1.0	1.0	0.0
1995.0	94.0	94.0	94.0	1.0	1.0	0.0
3981.0	94.0	94.0	94.0	1.0	1.0	0.0
7943.0	94.0	94.0	94.0	1.5	3.0	0.0
12590.0	94.0	94.0	94.0	3.0	6.0	0.0

TIME WEIGHTING FAST TEST

Time weighting F is tested on the reference range with a single sinusoidal burst of duration 200 ms at a frequency 2000 Hz and an amplitude which produces an indication 4 dB below the upper limit of the primary indicator range when the signal is continuous. (Weight A, Maximum hold)

Ref. level dB	Expected level dB	Actual level dB	Tolerance(dB)		Deviation dB
			+	-	
116.0	115.0	115.0	1.0	1.0	0.0

TIME WEIGHTING SLOW TEST

Time weighting S is tested on the reference range with a single sinusoidal burst of duration 500 ms at a frequency 2000 Hz and an amplitude which produces an indication 4 dB below the upper limit of the primary indicator range when the signal is continuous. (Weight A, Maximum hold)

Ref. level dB	Expected level dB	Actual level dB	Tolerance(dB)		Deviation dB
			+	-	
116.0	111.9	111.8	1.0	1.0	-0.1

PEAK RESPONSE TEST

The onset time of the peak detector is tested on the reference range by comparing the response to a 100 us rectangular test pulse with the response to a 10 ms reference pulse of the same amplitude. The amplitude of the 10 ms reference pulse is such as to produce an indication 1 dB below the upper limit of the primary indicator range. Positive polarities: (Weighting Z, set the generator signal to single, Lzpeak)

Ref. level dB	Response to 10 ms dB	Response to 100 us dB	Tolerance +/- dB	Deviation dB



Test Data for Sound Level Meter

Page 4 of 5

Sound level meter type: LxT1 Serial No. 0005062 Date 11-May-2023
Microphone type: 377B02 Serial No. 173734
Preamp type: PRMLxT1L Serial No. 042836 Report: 23CA0508 02-04

Negative polarities:

Ref. level	Response to 10 ms	Response to 100 us	Tolerance	Deviation
dB	dB	dB	+/- dB	dB
119.0	119.0	119.4	2.0	0.4

RMS ACCURACY TEST

The RMS detector accuracy is tested on the reference range for a crest factor of 3.

Test frequency: 2000 Hz
Amplitude: 2 dB below the upper limit of the primary indicator range.
Burst repetition frequency: 40 Hz
Tone burst signal: 11 cycles of a sine wave of frequency 2000 Hz. (Set to INT)

	Ref. Level	Expected level	Tone burst signal	Tolerance	Deviation
Time weighting	dB	dB	indication(dB)	+/- dB	dB
Slow	114.0+6.6	114.0	113.8	0.5	-0.2

TIME WEIGHTING IMPULSE TEST

Time weighting I is tested on the reference range (Set the SLM to LAImax)

Test frequency: 2000 Hz
Amplitude: The upper limit of the primary indicator range.

Single sinusoidal burst of duration 5 ms:

Ref. Level	Single burst indication		Tolerance	Deviation
dB	Expected (dB)	Actual (dB)	+/- dB	dB
120.0	111.2	111.1	2.0	-0.1

Repeated at 100 Hz

Ref. Level	Repeated burst indication		Tolerance	Deviation
dB	Expected (dB)	Actual (dB)	+/- dB	dB
120.0	117.3	117.1	1.0	-0.2

TIME AVERAGING TEST

This test compares the SLM reading for continuous sine signals with readings obtained from a sine tone burst sequence having the same RMS level. The test level is 30 dB below the upper limit of the linearity range and repeated for Type 1 SLM with 40 dB below the upper limit of the linearity.

Frequency of tone burst: 4000 Hz

Duration of tone burst: 1 ms

Repetition Time	Level of tone burst	Expected Leq	Actual Leq	Tolerance	Deviation	Remarks
msec	dB	dB	dB	+/- dB	dB	
1000	90.0	90.0	89.8	1.0	-0.2	60s integ.
10000	80.0	80.0	79.8	1.0	-0.2	6min. integ.

PULSE RANGE AND SOUND EXPOSURE LEVEL TEST

The test tone burst signal is superimposed on a baseline signal corresponding to the lower limit of reference range

Test frequency: 4000 Hz

Integration time: 10 sec



Test Data for Sound Level Meter

Page 5 of 5

Sound level meter type: LxT1 Serial No. 0005062 Date 11-May-2023
Microphone type: 377B02 Serial No. 173734
Preamp type: PRMLxT1L Serial No. 042836 Report: 23CA0508 02-04

The integrating sound level meter set to Leq:

Duration	Rms level of	Expected	Actual	Tolerance	Deviation
msec	tone burst (dB)	dB	dB	+/- dB	dB
10	90.0	60.0	60.0	1.7	0.0

The integrating sound level meter set to SEL:

Duration	Rms level of	Expected	Actual	Tolerance	Deviation
msec	tone burst (dB)	dB	dB	+/- dB	dB
10.0	90.0	70.0	70.0	1.7	0.0

OVERLOAD INDICATION TEST

For SLM capable of operating in a non-integrating mode.

Test frequency: 2000 Hz
Amplitude: 2 dB below the upper limit of the primary indicator range.
Burst repetition frequency: 40 Hz
Tone burst signal: 11 cycles of a sine wave of frequency 2000 Hz.

Level	Level reduced by	Further reduced	Difference	Tolerance	Deviation
at overload (dB)	1 dB	3 dB	dB	dB	dB
113.3	112.3	109.3	3.0	1.0	0.0

For integrating SLM, with the instrument indicating Leq.

For integrating SLM, with the instrument indicating Leq and set to the reference range. The test signal as following:
The test tone burst signal is superimposed on a baseline signal corresponding to the lower limit of reference range
Test frequency: 4000 Hz
Integration time: 10 sec
Single burst duration: 1 msec

Rms level	Level reduced by	Expected level	Actual level	Tolerance	Deviation
at overload (dB)	1 dB	dB	dB	dB	dB
120.0	119.0	79.0	79.0	2.2	0.0

ACOUSTIC TEST

The acoustic test of the complete SLM is tested at the frequency 125 Hz and 8000 Hz using a B&K type 4226 Multifunction Acoustic Calibrator. The test is performed in A weighting.

Frequency	Expected level	Actual level	Tolerance (dB)		Deviation
Hz	dB	Measured (dB)	+	-	dB
1000	94.0	94.0	0.0	0.0	0.0
125	77.9	77.9	1.0	1.0	0.0
8000	92.9	90.8	1.5	3.0	-2.1

-----END-----



CERTIFICATE OF CALIBRATION

Certificate No.: 24CA0205 01-02

Page: 1 of 2

Item tested

Description: Acoustical Calibrator (Class 1)
Manufacturer: Larson Davis
Type/Model No.: CAL200
Serial/Equipment No.: 13128
Adaptors used: -

Item submitted by

Customer: Lam Environmental Services Ltd.
Address of Customer: -
Request No.: -
Date of receipt: 05-Feb-2024

Date of test: 06-Feb-2024

Reference equipment used in the calibration

Description:	Model:	Serial No.	Expiry Date:	Traceable to:
Lab standard microphone	B&K 4180	3257888	15-Aug-2024	SCL
Preamplifier	B&K 2673	3353200	13-Jun-2024	CEPREI
Measuring amplifier	B&K 2610	2346941	13-Jun-2024	CEPREI
Signal generator	DS 360	61227	28-Jun-2024	CEPREI
Digital multi-meter	34401A	US36087050	01-Jun-2024	CEPREI
Audio analyzer	8903B	GB41300350	13-Jun-2024	CEPREI
Universal counter	53132A	MY40003662	07-Jun-2024	CEPREI

Ambient conditions

Temperature: 21 ± 1 °C
Relative humidity: 55 ± 10 %
Air pressure: 1005 ± 5 hPa

Test specifications

- The Sound Calibrator has been calibrated in accordance with the requirements as specified in IEC 60942 1997 Annex B and the lab calibration procedure SMTP004-CA-156.
- The calibrator was tested with its axis vertical facing downwards at the specific frequency using insert voltage technique.
- The results are rounded to the nearest 0.01 dB and 0.1 Hz and have not been corrected for variations from a reference pressure of 1013.25 hectoPascals as the maker's information indicates that the instrument is insensitive to pressure changes.

Test results

This is to certify that the sound calibrator conforms to the requirements of annex B of IEC 60942: 1997 for the conditions under which the test was performed. This does not imply that the sound calibrator meets IEC 60942 under any other conditions.

Details of the performed measurements are presented on page 2 of this certificate.

Approved Signatory:

Feng Junqi

Date: 07-Feb-2024

Company Chop:



Comments: The results reported in this certificate refer to the condition of the instrument on the date of calibration and carry no implication regarding the long-term stability of the instrument. The results apply to the item as received.



CERTIFICATE OF CALIBRATION

(Continuation Page)

Certificate No.: 24CA0205 01-02

Page: 2 of 2

1, Measured Sound Pressure Level

The output Sound Pressure Level in the calibrator head was measured at the setting and frequency shown using a calibrated laboratory standard microphone and insert voltage technique. The results are given in below with the estimated uncertainties.

Frequency Shown Hz	Output Sound Pressure Level Setting dB	Measured Output Sound Pressure Level dB	(Output level in dB re 20 μ Pa)
			Estimated Expanded Uncertainty dB
1000	94.00	93.74	0.10

2, Sound Pressure Level Stability - Short Term Fluctuations

The Short Term Fluctuations was determined by measuring the maximum and minimum of the fast weighted DC output of the B&K 2610 measuring amplifier over a 20 second time interval as required in the standard. The Short Term Fluctuation was found to be:

At 1000 Hz STF = 0.016 dB

Estimated expanded uncertainty 0.005 dB

3, Actual Output Frequency

The determination of actual output frequency was made using a B&K 4180 microphone together with a B&K 2673 preamplifier connected to a B&K 2610 measuring amplifier. The AC output of the B&K 2610 was taken to an universal counter which was used to determine the frequency averaged over 20 second of operation as required by the standard. The actual output frequency at 1 KHz was:

At 1000 Hz Actual Frequency = 999.4 Hz

Estimated expanded uncertainty 0.1 Hz Coverage factor k = 2.2

4, Total Noise and Distortion

For the Total Noise and Distortion measurement, the unfiltered AC output of the B&K 2610 measuring amplifier was connected to an Agilent Type 8903 B distortion analyser. The TND result at 1 KHz was:

At 1000 Hz TND = 0.8%

Estimated expanded uncertainty 0.7 %

The expanded uncertainties have been calculated in accordance with the ISO Publication "Guide to the expression of uncertainty in measurement", and gives an interval estimated to have a level of confidence of 95%. A coverage factor of 2 is assumed unless explicitly stated.

- End -

Calibrated by:

Date:

Fung Chi Yip
06-Feb-2024

Checked by:

Date:

Chan Yuk Yiu
07-Feb-2024

The standard(s) and equipment used in the calibration are traceable to national or international recognised standards and are calibrated on a schedule to maintain the required accuracy level.



ALS Technichem (HK) Pty Ltd

11/F., Chung Shun Knitting Centre,

1 - 3 Wing Yip Street,

Kwai Chung, N.T., Hong Kong

T: +852 2610 1044

F: +852 2610 2021

www.alsglobal.com

REPORT OF EQUIPMENT PERFORMANCE CHECK/CALIBRATION

CONTACT: DEREK LO
CLIENT: LAM ENVIRONMENTAL SERVICES LTD
ADDRESS: 19/F, REMEX CENTRE,
42 WONG CHUK HANG ROAD,
HONG KONG

WORK ORDER: HK2406440
SUB-BATCH: 0
LABORATORY: HONG KONG
DATE RECEIVED: 16-Feb-2024
DATE OF ISSUE: 27-Feb-2024

GENERAL COMMENTS

The performance of the equipment stated in this report is checked with independent reference material and results compared against a calibrated secondary source.

The "Tolerance Limit" quoted is the acceptance criteria applicable for similar equipment used by the laboratory or quoted from relevant international standards.

The "Next Calibration Date" is recommended according to best practice principle as practised by the laboratory or quoted from relevant international standards.

The validity of equipment/ meter performance only applies to the result(s) stated in the report.

This report superseded any previous report(s) with same work order number.

EQUIPMENT INFORMATION

Equipment information (Brand name, Model No., Serial No. and Equipment No.) is provided by client.

Equipment Type: Multifunctional Meter

Service Nature: Performance Check

Scope: Dissolved Oxygen, pH Value, Salinity and Temperature

Brand Name/ Model No.: [YSI]/ [Professional Plus]

Serial No./ Equipment No.: [16J104708/17F100236]/ [N/A]

Date of Calibration: 23-February-2024

Ms. Lin Wai Yu, Iris
Assistant Manager - Inorganics

This report may not be reproduced except with prior written approval from ALS Technichem (HK) Pty Ltd.

REPORT OF EQUIPMENT PERFORMANCE CHECK/CALIBRATION



WORK ORDER: HK2406440
SUB-BATCH: 0
DATE OF ISSUE: 27-Feb-2024
CLIENT: LAM ENVIRONMENTAL SERVICES LTD

Equipment Type: Multifunctional Meter
Brand Name/ Model No.: [YSI]/ [Professional Plus]
Serial No./ Equipment No.: [16J104708/17F100236]/ [N/A]
Date of Calibration: 23-February-2024 Date of Next Calibration: 23-May-2024

PARAMETERS:

Dissolved Oxygen Method Ref: APHA (23rd edition), 4500O: G

Expected Reading (mg/L)	Displayed Reading (mg/L)	Tolerance (mg/L)
2.99	2.84	-0.15
5.58	5.50	-0.08
7.11	7.15	+0.04
	Tolerance Limit (mg/L)	±0.20

pH Value Method Ref: APHA (23rd edition), 4500H: B

Expected Reading (pH unit)	Displayed Reading (pH unit)	Tolerance (pH unit)
4.0	4.08	+0.08
7.0	7.09	+0.09
10.0	10.00	+0.00
	Tolerance Limit (pH unit)	±0.20

Salinity Method Ref: APHA (23rd edition), 2520B

Expected Reading (ppt)	Displayed Reading (ppt)	Tolerance (%)
0	0.01	--
10	9.84	-1.6
20	19.76	-1.2
30	29.54	-1.5
	Tolerance Limit (%)	±10.0

Remark: "Displayed Reading" presents the figures shown on item under calibration / checking regardless of equipment precision or significant figures.

Ms. Lin Wai Yu, Iris
Assistant Manager - Inorganics

REPORT OF EQUIPMENT PERFORMANCE CHECK/CALIBRATION



WORK ORDER: HK2406440
SUB-BATCH: 0
DATE OF ISSUE: 27-Feb-2024
CLIENT: LAM ENVIRONMENTAL SERVICES LTD

Equipment Type: Multifunctional Meter
Brand Name/ Model No.: [YSI]/ [Professional Plus]
Serial No./ Equipment No.: [16J104708/17F100236]/ [N/A]
Date of Calibration: 23-February-2024 Date of Next Calibration: 23-May-2024

PARAMETERS:

Temperature

Method Ref: Section 6 of International Accreditation New Zealand Technical Guide No. 3 Second edition March 2008: Working Thermometer Calibration Procedure.

Expected Reading (°C)	Displayed Reading (°C)	Tolerance (°C)
6.5	6.4	-0.1
22.5	22.4	-0.1
43.5	42.5	-1.0
	Tolerance Limit (°C)	±2.0

Remark: "Displayed Reading" presents the figures shown on item under calibration / checking regardless of equipment precision or significant figures.

Ms. Lin Wai Yu, Iris
Assistant Manager - Inorganics



Calibration Report

Calibration No. : 52508051- A29E3201

Laboratory : FT LaboratoriesLtd.

Address : Lot No. DD77 Section 1552 S.Ass 1RP, Ng Chow South Road, Ping Che, Fanling, New Territories

Telephone : (852) 2758 4861

Facsimile : (852) 2758 8962

Customer : Lam Environmental Services Limited

Address : 19/F., Remex Centre, 42 Wong Chuk Hang Road, Hong Kong

Item Calibrated : Name/Description: Turbidimeter

Manufacturer: Shanghai Xinrui Instruments & Meters co.,Ltd

Model no: WGZ-3B

Equipment no.: 1807073

Reference Standard / : C23/01 under NCRM reference material number GBW(E) 120125.

Major Measurement : Standard Solution of Formazine Turbidity

Equipment

Calibration Method : In-house calibration method according to Ref: APHA22nd ed 213 OB

Date of item received : 29 Jan.,2024

Date of Calibration : 05 Feb.,2024

Location of Calibration : Chemical Laboratory of FT LaboratoriesLtd.

Calibration Conditions

Temperature : 20 ± 3 °C

Relative Humidity : 30% to 80%

Test Results : The test results are detailed in the subsequent page(s).

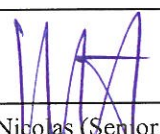
Certified by :  Date of Issue: - 9 FEB 2024

CHAN Joseph Nicolas (Senior Technical Engineer)

Notes: (1) The above equipment has been calibrated against standards which are traceable to internationally recognized standards.

(2) This certificate shall not be reproduced, except in full, without the written approval of FT LaboratoriesLtd.



Calibration Report

Calibration No. : 52508051- A29E3201

Results

Turbidity of standard solution used (NTU)	Measured value (NTU)	Error (%)
0	0	---
4	4.00	0.00%
10	10.00	0.00%
40	39.98	-0.05%
100	99.96	-0.04%
400	399.1	-0.22%
1000	999.2	-0.08%

Remarks:

- (A) Each reported result is the mean of three measurements on UUT (unit-under-test).
- (B) The values given in this Calibration Report only relate to the unit-under-test and the values measured at the time of the test. Any uncertainties quoted will not include allowances for the environmental changes, variation and shock during transportation, or the capability of any other laboratory to repeat the measurement.
- (C) Before calibration, UUT and reference equipment was placed in the laboratory for at least one hour.

< End of Report >

Calibrated by: CH Cheung
Date: 05 Feb., 2024

Checked by: Joseph Chan
Date: 9 FEB 2024



Appendix 4.2

Impact Monitoring Schedule for Reporting Month and Next Month



CONTRACT NO: SD 15/2022
OUTLYING ISLAND SEWERAGE STAGE 2 – SOUTH LANTAU SEWAGE WORKS –
ENVIRONMENTAL TEAM SERVICES (2023 – 2024)
Impact Environmental Monitoring Schedule
Mar 2024

Note:

*Mid-tide time during daylight period of the ebb/flood tide is scheduled in consideration of navigation safety and to capture major marine works operation.

Sunday	Monday	Tuesday	Wednesday	Thursday	Friday	Saturday
25 Feb	26 Feb	27 Feb	28 Feb	29 Feb	01 Mar	02 Mar
	Mid-Ebb 13:31 Mid-Flood 7:52		Mid-Ebb 14:29 Mid-Flood 8:32	Noise Monitoring	Mid-Ebb 15:38 Mid-Flood 9:16	
03 Mar	04 Mar	05 Mar	06 Mar	07 Mar	08 Mar	09 Mar
		Mid-Ebb 18:45* Mid-Flood 8:18		Mid-Ebb 10:40* Mid-Flood 15:06		WQM for Mid-Flood and Mid-Edd suspended due to Strong Monsoon Signal Mid-Ebb 12:07 Mid-Flood 17:23
10 Mar	11 Mar	12 Mar	13 Mar	14 Mar	15 Mar	16 Mar
	Mid-Ebb 13:15 Mid-Flood 7:22		WQM for Mid-ebb suspended due to Strong Monsoon Signal Mid-Ebb 14:29 Mid-Flood 8:17	Noise Monitoring	Mid-Ebb 16:01 Mid-Flood 9:15	
17 Mar	18 Mar	19 Mar	20 Mar	21 Mar	22 Mar	23 Mar
		Mid-Ebb 18:45* Mid-Flood 8:52		Noise Monitoring		Mid-Ebb 11:56 Mid-Flood 17:31
24 Mar	25 Mar	26 Mar	27 Mar	28 Mar	29 Mar	30 Mar
	Mid-Ebb 12:36 Mid-Flood 18:44		Mid-Ebb 13:30 Mid-Flood 7:22	Noise Monitoring	Mid-Ebb 14:30 Mid-Flood 8:01	



CONTRACT NO: SD 15/2022
OUTLYING ISLAND SEWERAGE STAGE 2 – SOUTH LANTAU SEWAGE WORKS –
ENVIRONMENTAL TEAM SERVICES (2023 – 2024)
Tentative Impact Marine Water Quality Monitoring Schedule (Rev. 3)
Apr 2024

Note:

*Mid-tide time during daylight period of the ebb/flood tide is scheduled in consideration of navigation safety and to capture major marine works operation.

Sunday	Monday	Tuesday	Wednesday	Thursday	Friday	Saturday
31 Mar	01 Apr	02 Apr	03 Apr	04 Apr	05 Apr	06 Apr
	Mid-Ebb 16:53 Mid-Flood 9:00*		Mid-Ebb 18:45* Mid-Flood 8:00*		Mid-Ebb 10:25* Mid-Flood 15:13	
07 Apr	08 Apr	09 Apr	10 Apr	11 Apr	12 Apr	13 Apr
	Mid-Ebb 12:09 Mid-Flood 18:12		Mid-Ebb 13:24 Mid-Flood 7:03		Mid-Ebb 14:50 Mid-Flood 8:03	
14 Apr	15 Apr	16 Apr	17 Apr	18 Apr	19 Apr	20 Apr
	Mid-Ebb 17:43 Mid-Flood 8:00*		Mid-Ebb 18:45* Mid-Flood 9:30*		Mid-Ebb 10:41 Mid-Flood 15:49	
21 Apr	22 Apr	23 Apr	24 Apr	25 Apr	26 Apr	27 Apr
	Mid-Ebb 11:42 Mid-Flood 17:57		Mid-Ebb 12:34 Mid-Flood 18:05*		Mid-Ebb 13:31 Mid-Flood 6:52	
28 Apr	29 Apr	30 Apr	01 May	02 May	03 May	04 May
	Mid-Ebb 15:30 Mid-Flood 7:44			Mid-Ebb 17:40* Mid-Flood 9:00*		Mid-Ebb 9:50 Mid-Flood 15:08



Appendix 4.3

Noise Monitoring Results and Graphical Presentations

Graphic Presentation of Noise Monitoring Result
 Day Time (0700 - 1900hrs on normal weekdays)

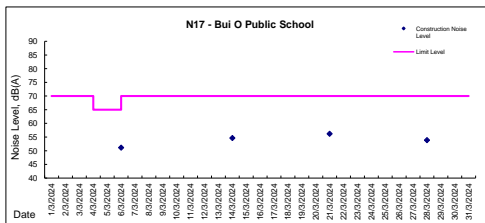
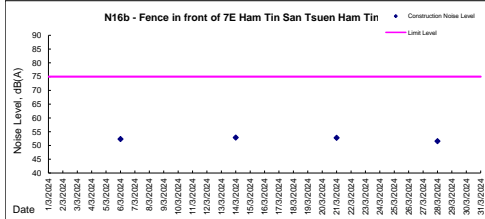
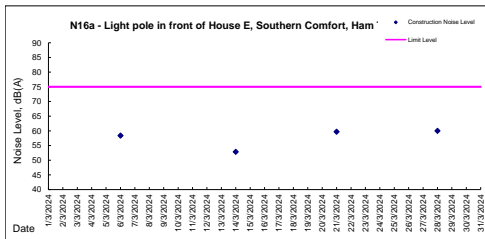
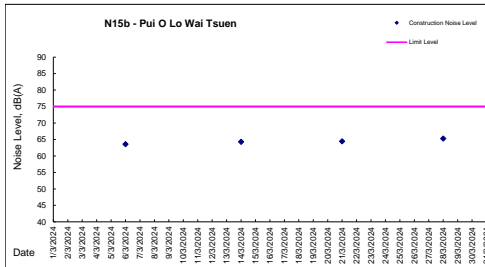
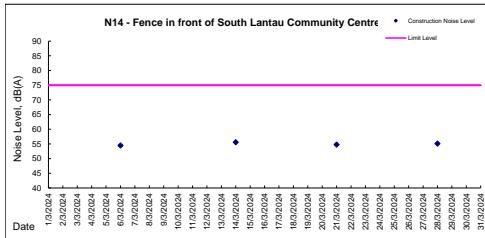
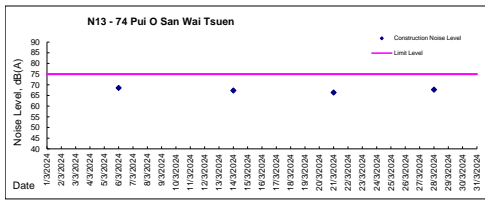
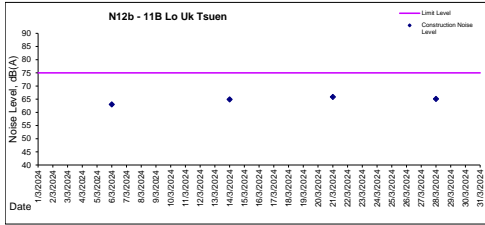
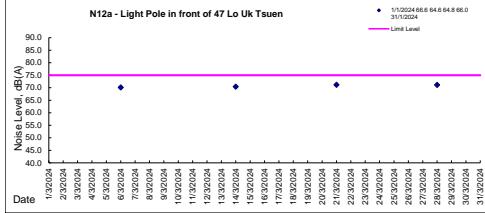



Noise Monitoring Result

Day Time (0700 - 1900hrs on normal weekdays)

Location: N12a - Light Pole in front of 47 Lo Uk Tsuen

Date	Weather	Wind Speed	Calibration Check	Time	Measurement Noise Level			Average Noise Level	Baseline Level	Construction Noise Level	Action Level	Major Construction Noise Source(s)*	Other Noise Source(s)
					Leq	L10	L90						
					Unit: dB(A), (5-min)								
6 Mar 2024	Sunny	0.0	94.1	14:15	68.6	71.8	58.4	70.1	73.3	<Baseline Level	75	N/A	Traffic
				14:20	73.1	75.6	59.5						
				14:25	67.8	71.3	56.8						
				14:30	71.8	73.5	60.2						
				14:35	67.3	70.5	67.2						
				14:40	68.6	71.6	67.5						
14 Mar 2024	Sunny	0.0	94.1	14:15	70.2	73.1	61.2	70.4	73.3	<Baseline Level	75	N/A	Traffic
				14:20	71.7	74.4	61.3						
				14:25	66.9	70.2	63.4						
				14:30	71.3	73.4	61.4						
				14:35	70.6	73.6	66.4						
				14:40	70.3	73.3	65.6						
21 Mar 2024	Sunny	0.0	94.1	14:15	71.3	74.5	62.6	71.2	73.3	<Baseline Level	75	N/A	Traffic
				14:20	70.6	73.6	61.8						
				14:25	65.5	68.6	56.7						
				14:30	70.5	73.5	61.7						
				14:35	73.8	77.2	65.1						
				14:40	71.8	75.1	63.2						
28 Mar 2024	Sunny	0.0	94.1	14:15	71.5	75.5	61.2	71.1	73.3	<Baseline Level	75	N/A	Traffic
				14:20	69.9	73.4	65.1						
				14:25	67.8	72.2	62.3						
				14:30	70.6	74.7	62.6						
				14:35	74.1	77.5	63.5						
				14:40	70.3	74.5	63.6						

* N/A refers to no major construction noise observed during noise monitoring



Noise Monitoring Result

Day Time (0700 - 1900hrs on normal weekdays)

Location: N12b - 11B Lo Uk Tsuen

Date	Weather	Wind Speed	Calibration Check	Time	Measurement Noise Level			Average Noise Level	Baseline Level	Construction Noise Level	Action Level	Major Construction Noise Source(s)*	Other Noise Source(s)
					Leq	L10	L90						
					Unit: dB(A), (5-min)								
6 Mar 2024	Sunny	0.0	94.1	13:40	62.9	67.4	55.5	63.0	76.8	<Baseline Level	75	N/A	Traffic
				13:45	62.8	68.5	55.6						
				13:50	61.3	67.6	55.2						
				13:55	64.5	64.8	54.3						
				14:00	63.5	68.4	55.8						
14 Mar 2024	Sunny	0.0	94.1	14:05	62.3	65.3	56.4	64.9	76.8	<Baseline Level	75	N/A	Traffic
				13:40	63.8	68.3	56.1						
				13:45	65.2	69.1	56.4						
				13:50	64.0	69.2	55.7						
				13:55	64.8	70.2	58.2						
21 Mar 2024	Sunny	0.0	94.1	14:00	66.4	71.0	56.3	65.9	76.8	<Baseline Level	75	N/A	Traffic
				14:05	64.8	68.5	56.7						
				13:40	62.8	67.9	54.2						
				13:45	63.5	68.4	56.8						
				13:50	64.6	69.5	55.5						
28 Mar 2024	Sunny	0.0	94.1	13:55	68.1	73.2	59.7	65.1	76.8	<Baseline Level	75	N/A	Traffic
				14:00	67.8	72.6	54.2						
				14:05	65.6	70.3	53.2						
				13:40	63.5	66.5	53.1						
				13:45	64.5	68.8	55.8						

* N/A refers to no major construction noise observed during noise monitoring



Noise Monitoring Result

Day Time (0700 - 1900hrs on normal weekdays)

Location: N13 - 74 Pui O San Wai Tsuen

Date	Weather	Wind Speed	Calibration Check	Time	Measurement Noise Level			Average Noise Level Leq	Baseline Level Leq	Construction Noise Level Leq	Action Level Leq	Major Construction Noise Source(s)*	Other Noise Source(s)
					Leq	L10	L90						
					Unit: dB(A), (5-min)								
6 Mar 2024	Sunny	0.0	94.1	11:30	67.8	71.5	60.6	68.6	73.6	<Baseline Level	75	N/A	Traffic
				11:35	70.2	73.5	62.4						
				11:40	66.5	70.2	60.3						
				11:45	66.4	70.6	62.5						
				11:50	71.3	75.6	64.4						
11:55	66.2	67.5	59.8										
14 Mar 2024	Sunny	0.0	94.1	11:30	68.4	72.1	61.4	67.3	73.6	<Baseline Level	75	N/A	Traffic
				11:35	67.2	71.8	61.0						
				11:40	66.7	71.5	60.3						
				11:45	65.2	68.3	58.6						
				11:50	68.7	72.2	62.0						
11:55	66.7	69.4	60.0										
21 Mar 2024	Sunny	0.0	94.1	11:30	68.7	72.8	61.2	66.4	73.6	<Baseline Level	75	N/A	Traffic
				11:35	65.9	70.2	58.6						
				11:40	66.4	70.6	59.1						
				11:45	61.3	65.7	53.8						
				11:50	65.8	68.9	58.6						
11:55	67.2	71.2	59.1										
28 Mar 2024	Sunny	0.0	94.1	11:30	68.4	73.0	62.0	67.8	73.6	<Baseline Level	75	N/A	Traffic
				11:35	69.6	74.3	62.5						
				11:40	67.1	70.0	59.8						
				11:45	65.4	69.8	57.3						
				11:50	67.2	71.5	59.9						
11:55	67.7	72.6	59.6										

* N/A refers to no major construction noise observed during noise monitoring



Noise Monitoring Result

Day Time (0700 - 1900hrs on normal weekdays)

Location: N14 - South Lantau Community Centre

Date	Weather	Wind Speed	Calibration Check	Time	Measurement Noise Level			Average Noise Level	Baseline Level	Construction Noise Level	Action Level	Major Construction Noise	Other Noise Source(s)
					Leq	L10	L90	Leq	Leq	Leq	Leq		
					Unit: dB(A), (5-min)			Unit: dB(A), (30-min)					
6 Mar 2024	Sunny	0.0	94.1	10:55	53.5	55.7	44.9	54.5	62.2	<Baseline Level	75	N/A	Traffic
				11:00	54.1	56.3	45.6						
				11:05	54.6	56.8	46.9						
				11:10	55.9	58.1	45.7						
				11:15	54.2	56.5	45.6						
				11:20	54.2	56.5	46.8						
14 Mar 2024	Sunny	0.0	94.1	10:55	54.6	56.8	47.1	55.6	62.2	<Baseline Level	75	N/A	Traffic
				11:00	54.9	58.9	46.7						
				11:05	56.7	58.1	48.2						
				11:10	56.7	58.2	46.6						
				11:15	55.0	57.3	47.3						
				11:20	55.3	57.5	47.3						
21 Mar 2024	Sunny	0.0	94.1	10:55	53.9	56.5	47.0	54.8	62.2	<Baseline Level	75	N/A	Traffic
				11:00	54.0	56.7	47.2						
				11:05	55.4	58.0	47.2						
				11:10	56.1	58.8	45.1						
				11:15	54.1	56.8	46.7						
				11:20	54.8	57.1	47.4						
28 Mar 2024	Sunny	0.0	94.1	10:55	54.3	57.2	44.7	55.1	62.2	<Baseline Level	75	N/A	Traffic
				11:00	53.4	56.2	44.8						
				11:05	55.2	56.9	45.5						
				11:10	56.8	57.5	44.5						
				11:15	53.9	58.6	45.2						
				11:20	56.2	57.3	46.4						

* N/A refers to no major construction noise observed during noise monitoring



Noise Monitoring Result

Day Time (0700 - 1900hrs on normal weekdays)

Location: N15b - Pole in front of 7A Pui O Lo Wai Tsuen

Date	Weather	Wind Speed	Calibration Check	Time	Measurement Noise Level			Average Noise Level	Baseline Level	Construction Noise Level	Limit Level	Major Construction Noise Source(s)*	Other Noise Source(s)
					Leq	L10	L90						
					Unit: dB(A), (5-min)								
6 Mar 2024	Sunny	0.0	94.1	15:00	64.3	67.9	60.5	63.6	70.7	<Baseline Level	75	N/A	Traffic
				15:05	62.7	66.4	58.6						
				15:10	64.1	67.8	59.4						
				15:15	64.1	67.7	60.0						
				15:20	62.6	66.3	58.5						
15:25	63.4	67.0	58.9										
14 Mar 2024	Sunny	0.0	94.1	15:00	64.2	67.5	60.3	64.3	70.7	<Baseline Level	75	N/A	Traffic, Beverage Factory
				15:05	63.1	66.4	58.7						
				15:10	66.2	68.7	58.7						
				15:15	64.7	68.0	59.4						
				15:20	63.4	66.8	58.4						
15:25	63.4	66.7	58.4										
21 Mar 2024	Sunny	0.0	94.1	15:00	64.1	67.3	59.7	64.5	70.7	<Baseline Level	75	N/A	Traffic
				15:05	63.2	66.6	58.6						
				15:10	66.4	69.8	57.2						
				15:15	65.3	68.6	59.5						
				15:20	63.6	67.3	57.6						
15:25	63.2	66.6	57.3										
28 Mar 2024	Sunny	0.0	94.1	15:00	65.3	69.1	60.6	65.3	70.7	<Baseline Level	75	N/A	Traffic
				15:05	63.2	67.9	59.8						
				15:10	66.2	70.2	58.6						
				15:15	66.0	69.7	61.7						
				15:20	64.5	67.5	58.7						
15:25	65.9	69.2	58.5										

* N/A refers to no major construction noise observed during noise monitoring



Noise Monitoring Result

Day Time (0700 - 1900hrs on normal weekdays)

Location: N16a - Light pole in front of House E, Southern Comfort, Ham Tin

Date	Weather	Wind Speed	Calibration Check	Time	Measurement Noise Level			Average Noise Level	Baseline Level	Construction Noise Level	Action Level	Major Construction Noise Source(s)*	Other Noise Source(s)
					Leq	L10	L90						
					Unit: dB(A), (5-min)								
6 Mar 2024	Sunny	0.0	94.1	9:45	58.5	60.9	43.5	58.4	68.1	<Baseline Level	75	Crane	Traffic
				9:50	58.6	57.9	45.2						
				9:55	56.9	59.7	45.3						
				10:00	58.2	61.0	47.4						
				10:05	57.8	60.7	48.0						
10:10	59.9	62.8	48.2										
14 Mar 2024	Sunny	0.0	94.1	9:45	60.4	63.2	45.8	60.9	68.1	<Baseline Level	75	N/A	Traffic
				9:50	61.2	62.0	47.1						
				9:55	61.8	64.2	48.6						
				10:00	61.3	64.2	47.5						
				10:05	59.9	63.2	48.3						
10:10	60.4	63.4	47.9										
21 Mar 2024	Sunny	0.0	94.1	9:45	59.0	61.6	47.6	59.7	68.1	<Baseline Level	75	N/A	Traffic
				9:50	59.9	62.4	48.2						
				9:55	61.5	64.1	49.1						
				10:00	60.6	63.2	48.6						
				10:05	58.7	61.3	47.0						
10:10	57.4	60.0	46.7										
28 Mar 2024	Sunny	0.0	94.1	9:45	59.6	61.0	48.4	60.0	68.1	<Baseline Level	75	N/A	Traffic
				9:50	58.8	61.3	49.2						
				9:55	61.6	63.0	50.1						
				10:00	60.3	63.8	48.2						
				10:05	59.8	61.3	48.1						
10:10	59.5	61.8	48.6										

* N/A refers to no major construction noise observed during noise monitoring



Noise Monitoring Result

Day Time (0700 - 1900hrs on normal weekdays)

Location: N16b - Fence in front of 7E Ham Tin San Tsuen, Ham Tin

Date	Weather	Wind Speed	Calibration Check	Time	Measurement Noise Level			Average Noise Level	Baseline Level	Construction Noise Level	Action Level	Major Construction Noise	Other Noise Source(s)
					Leq	L10	L90						
					Unit: dB(A), (5-min)			Unit: dB(A), (30-min)					
6 Mar 2024	Sunny	0.0	94.1	10:20	50.6	52.7	43.4	52.3	68.5	<Baseline Level	75	N/A	Traffic
				10:25	51.5	53.6	44.2						
				10:30	53.3	55.2	45.3						
				10:35	53.0	55.0	45.6						
				10:40	52.1	54.2	45.1						
14 Mar 2024	Sunny	0.0	94.1	10:20	51.0	53.1	41.5	52.9	68.5	<Baseline Level	75	N/A	Traffic
				10:25	52.1	54.8	43.2						
				10:30	53.2	56.4	44.5						
				10:35	53.2	55.7	44.8						
				10:40	52.6	55.2	43.8						
21 Mar 2024	Sunny	0.0	94.1	10:20	51.2	53.3	42.5	52.8	68.5	<Baseline Level	75	N/A	Traffic
				10:25	52.7	54.6	44.3						
				10:30	52.2	55.0	43.9						
				10:35	52.6	54.9	44.7						
				10:40	52.3	54.7	44.5						
28 Mar 2024	Sunny	0.0	94.1	10:20	51.2	52.9	44.5	51.6	68.5	<Baseline Level	75	N/A	Traffic
				10:25	51.5	53.2	46.5						
				10:30	51.6	53.6	45.1						
				10:35	50.6	52.8	44.4						
				10:40	51.3	53.4	44.3						
10:45	52.8	56.1	45.0										

* N/A refers to no major construction noise observed during noise monitoring



Noise Monitoring Result

Day Time (0700 - 1900hrs on normal weekdays)

Location: N17 - Bui O Public School

Date	Weather	Wind Speed	Calibration Check	Time	Measurement Noise Level			Average Noise Level	Baseline Level	Construction Noise Level	Limit Level	Major Construction Noise Source(s)*	Other Noise Source(s)
					Leq	L10	L90						
					Unit: dB(A), (5-min)								
6 Mar 2024	Sunny	0.2	94.1	13:00	52.1	54.7	48.0	51.1	62.3	<Baseline Level	65	N/A	Traffic
				13:05	51.4	54.1	46.9						
				13:10	50.7	53.9	46.3						
				13:15	50.2	54.3	46.6						
				13:20	51.5	54.3	47.7						
13:25	50.6	53.5	46.4										
14 Mar 2024	Sunny	0.1	94.1	13:00	54.2	56.8	49.5	54.6	62.3	<Baseline Level	70	N/A	Traffic
				13:05	54.1	56.9	49.2						
				13:10	54.6	58.2	49.0						
				13:15	55.3	58.2	48.9						
				13:20	54.9	57.8	49.7						
13:25	54.6	57.1	49.5										
21 Mar 2024	Sunny	0.0	94.1	13:00	54.6	57.8	48.8	56.2	62.3	<Baseline Level	70	N/A	Traffic
				13:05	55.1	58.1	49.5						
				13:10	57.3	60.7	49.6						
				13:15	56.6	60.9	49.2						
				13:20	56.6	59.8	49.6						
13:25	56.3	59.3	50.5										
28 Mar 2024	Sunny	0.0	94.1	13:00	51.6	55.6	46.2	53.9	62.3	<Baseline Level	70	N/A	Traffic
				13:05	52.5	55.8	47.3						
				13:10	53.2	56.7	46.5						
				13:15	54.9	58.7	48.1						
				13:20	54.9	58.1	48.3						
13:25	54.9	58.7	48.6										

* N/A refers to no major construction noise observed during noise monitoring



Appendix 4.4

Marine Water Quality Monitoring Results and Graphical Presentations



Graphic Presentation of WQM Result

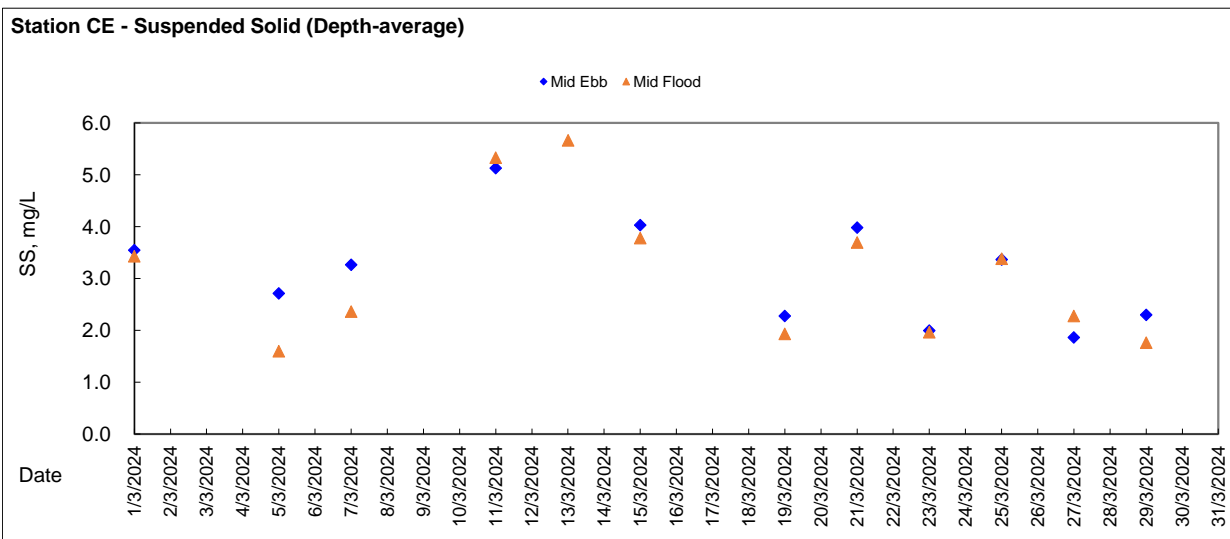
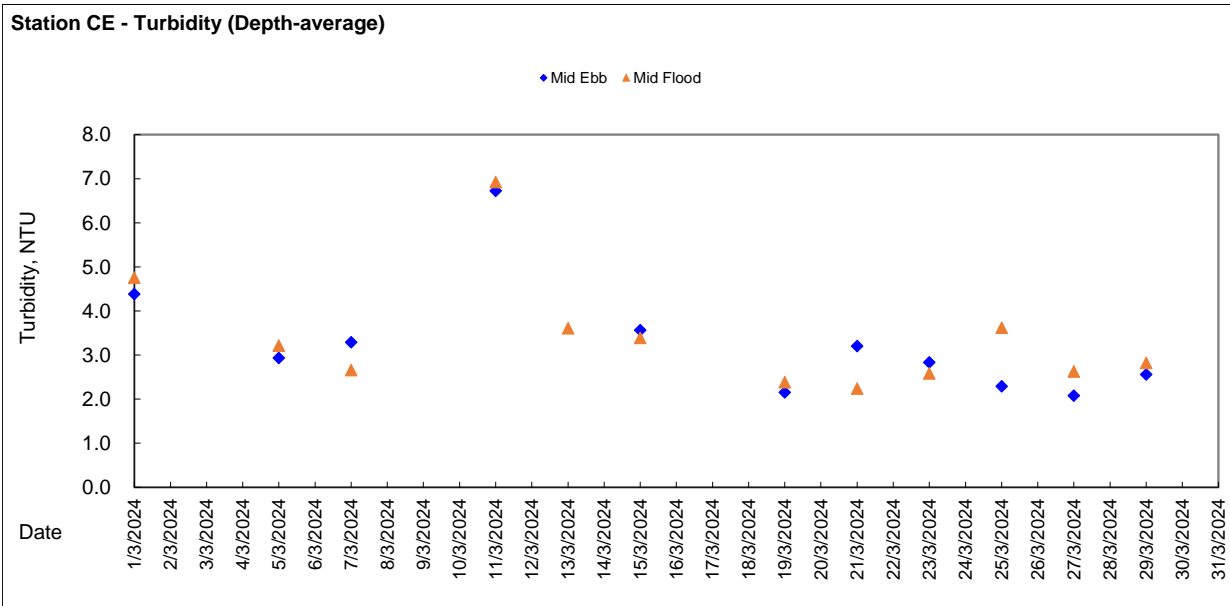
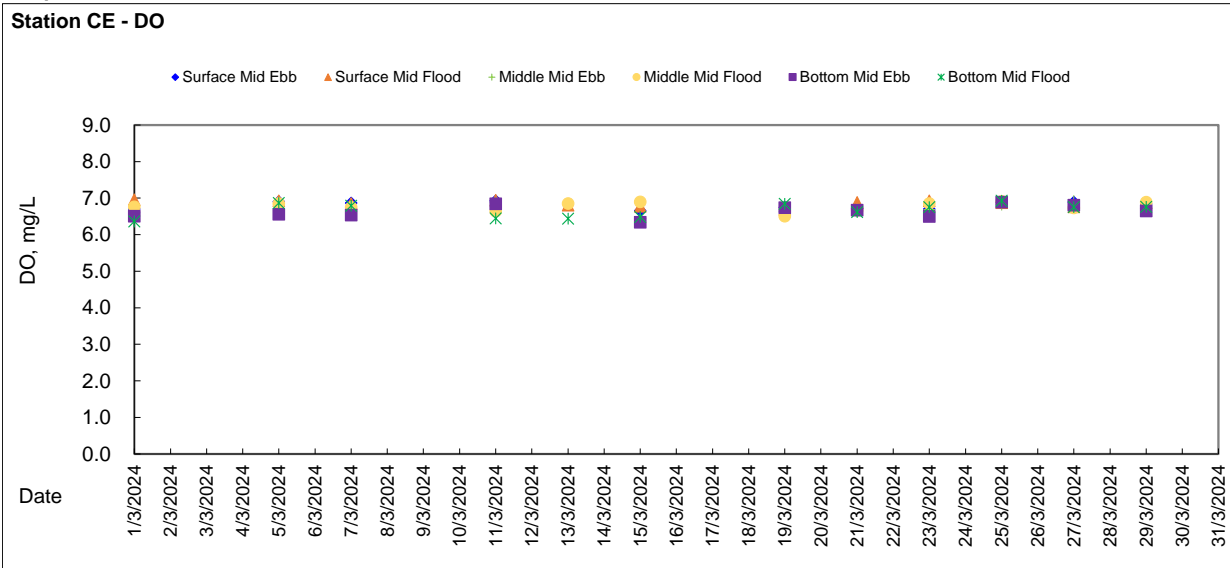



Graphic Presentation of WQM Result

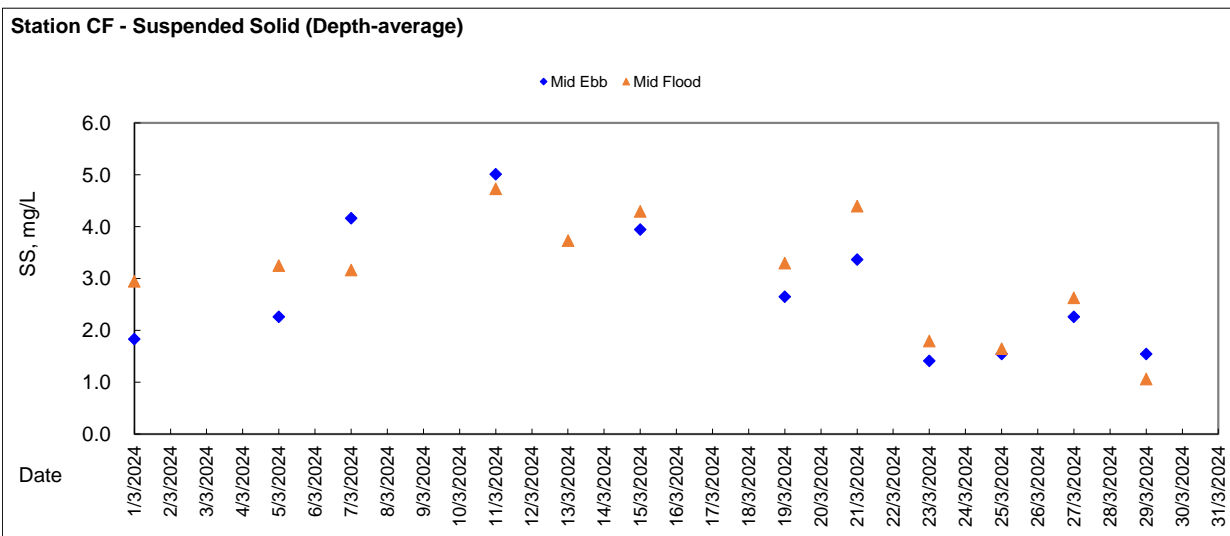
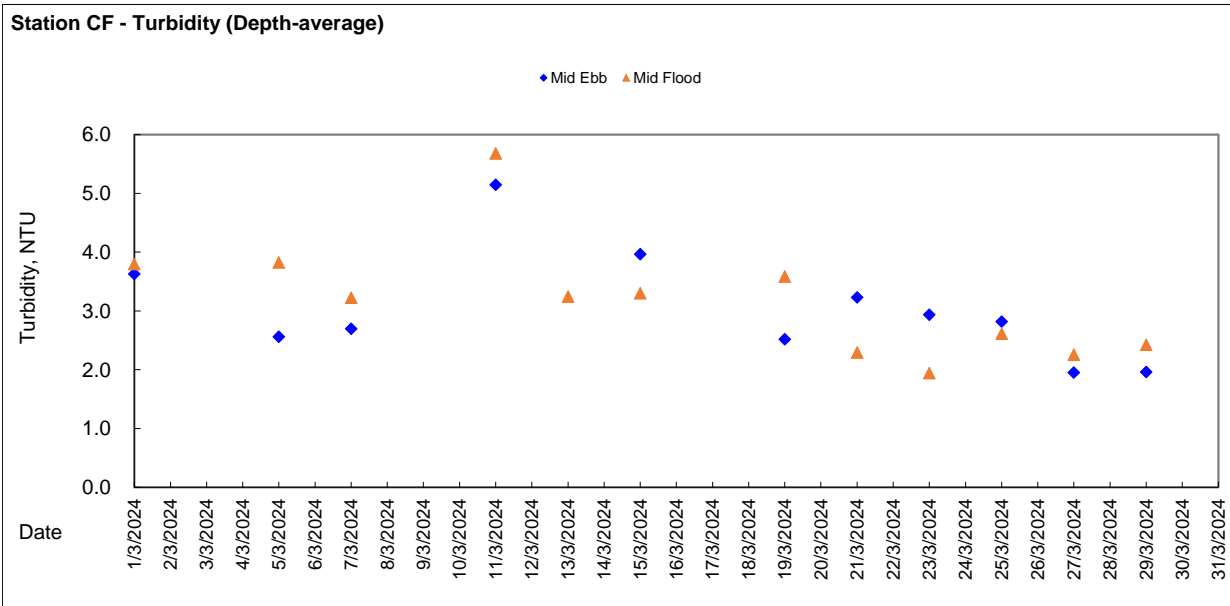
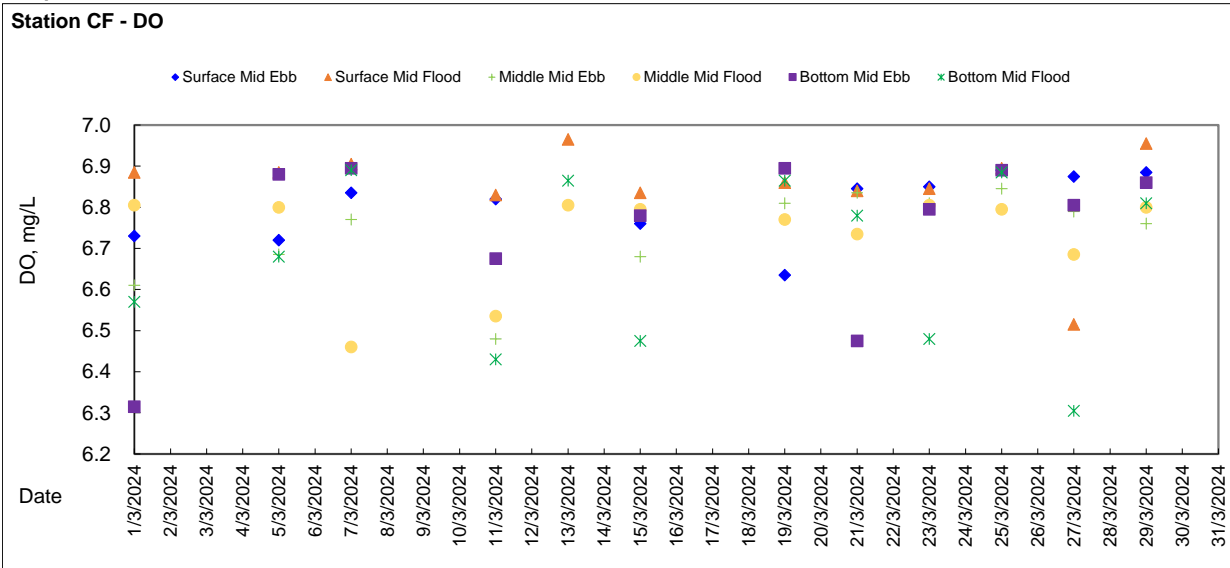



Graphic Presentation of WQM Result

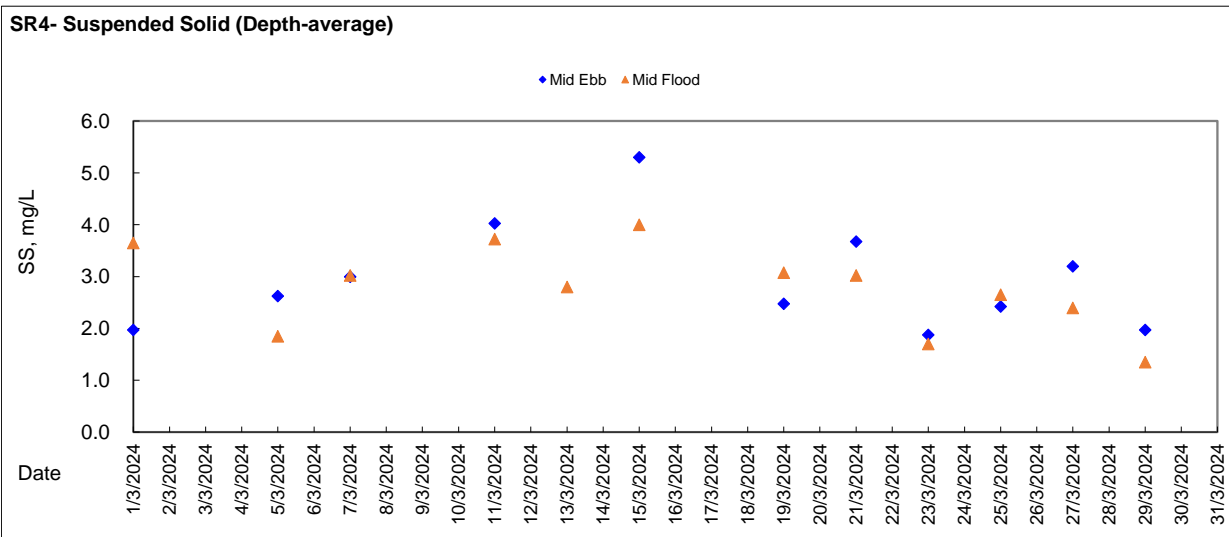
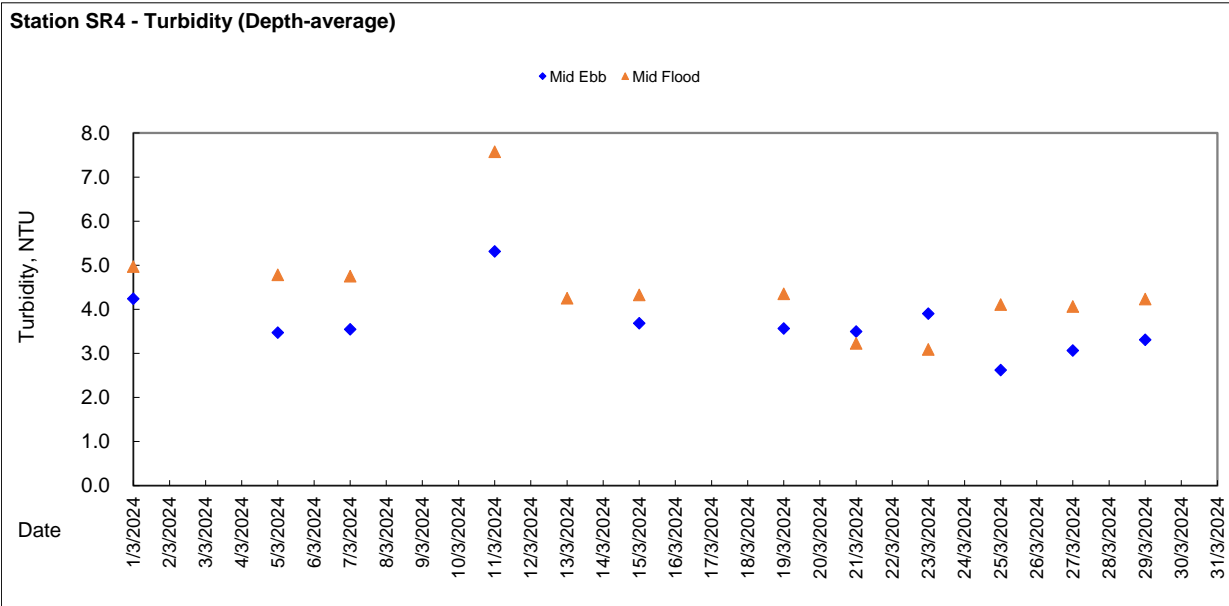
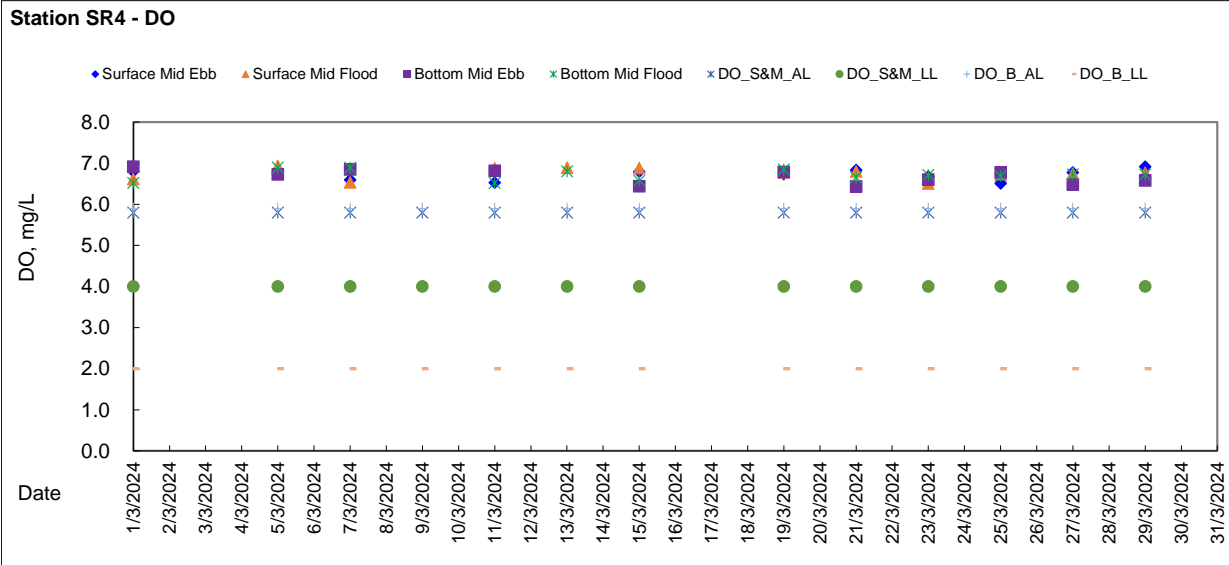



Graphic Presentation of WQM Result

Station SR5 - DO

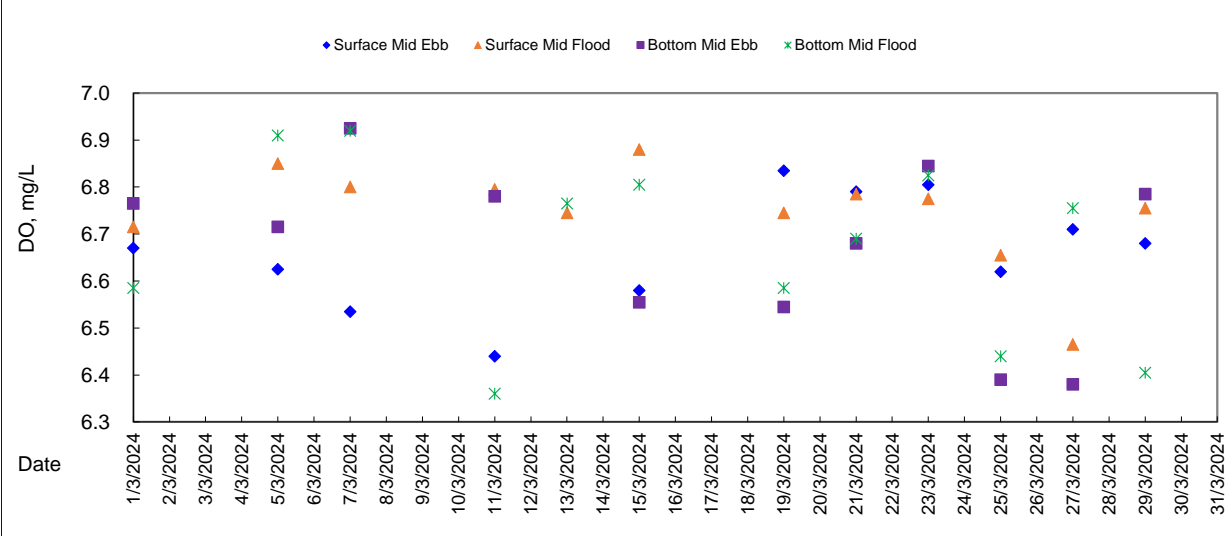

Station SR5 - Turbidity (Depth-average)

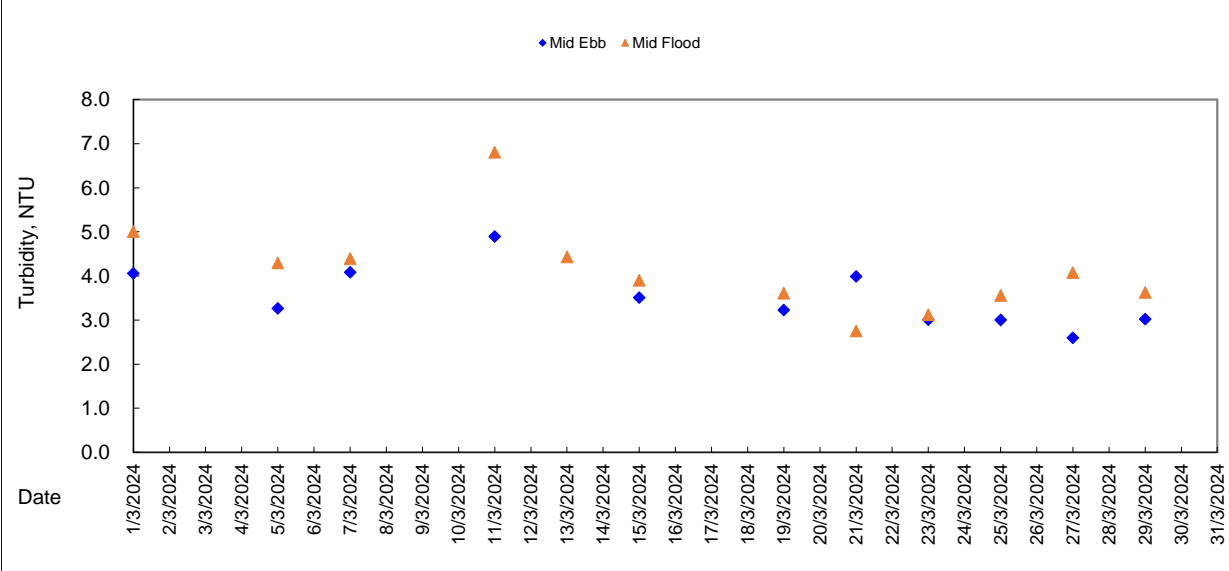

Station SR5 - Suspended Solid (Depth-average)

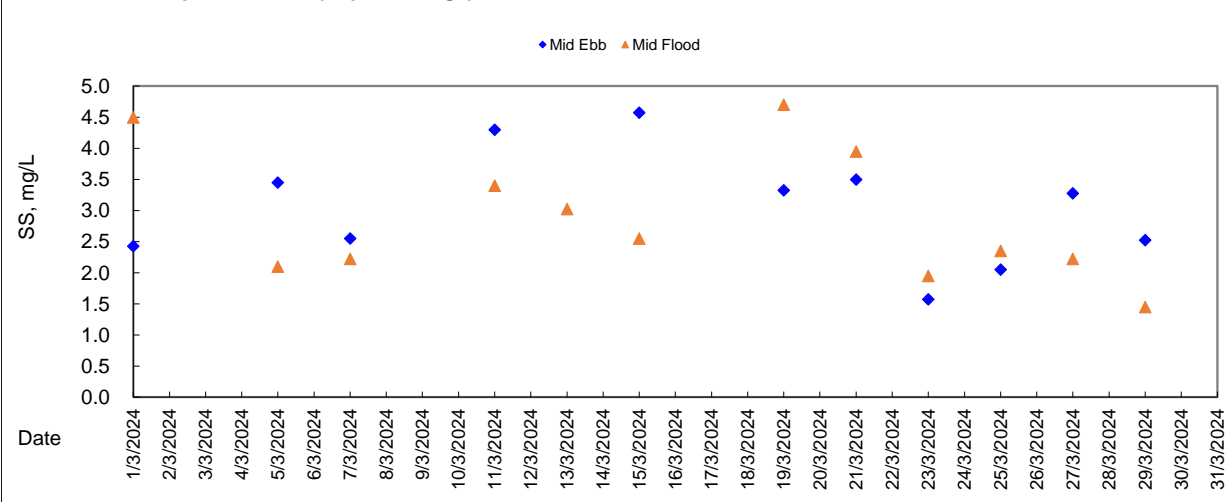



Graphic Presentation of WQM Result

Station SR6 - DO

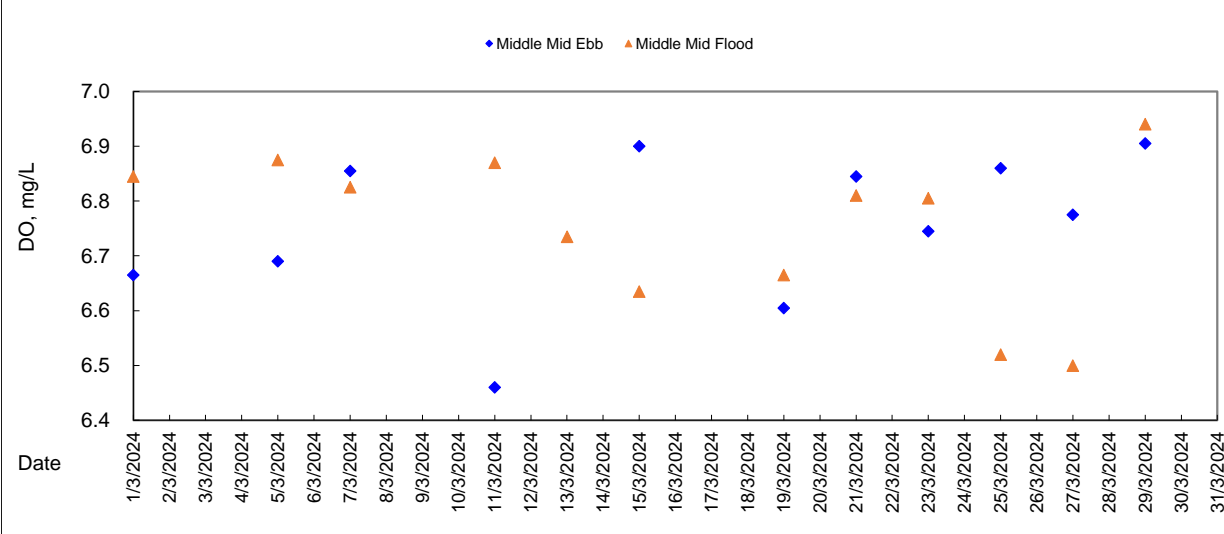

Station SR6 - Turbidity (Depth-average)

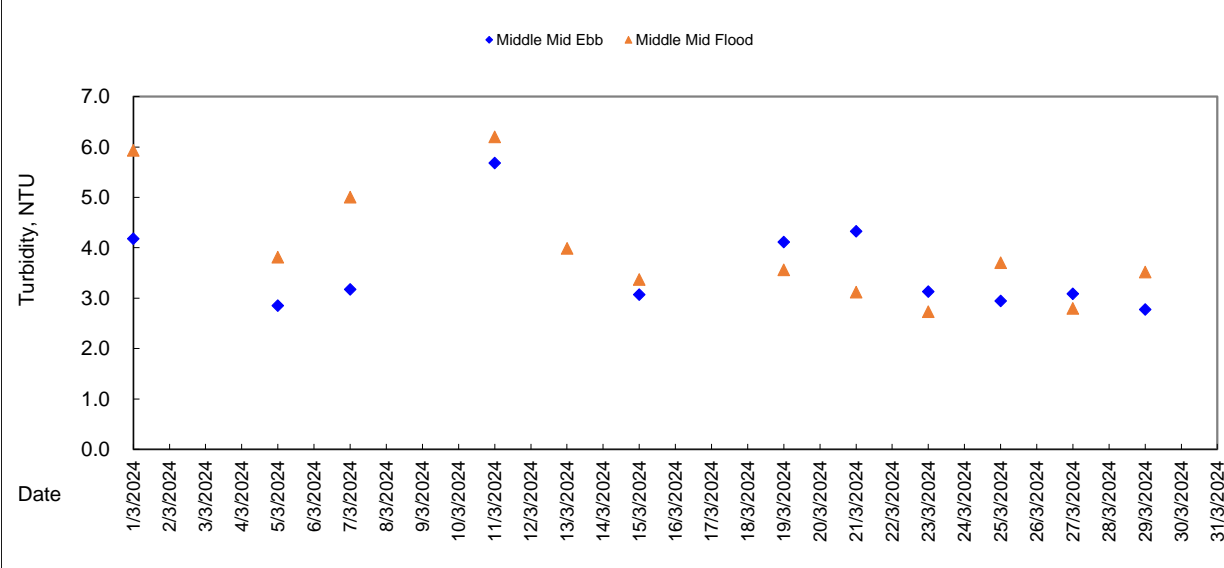

Station SR6 - Suspended Solid (Depth-average)

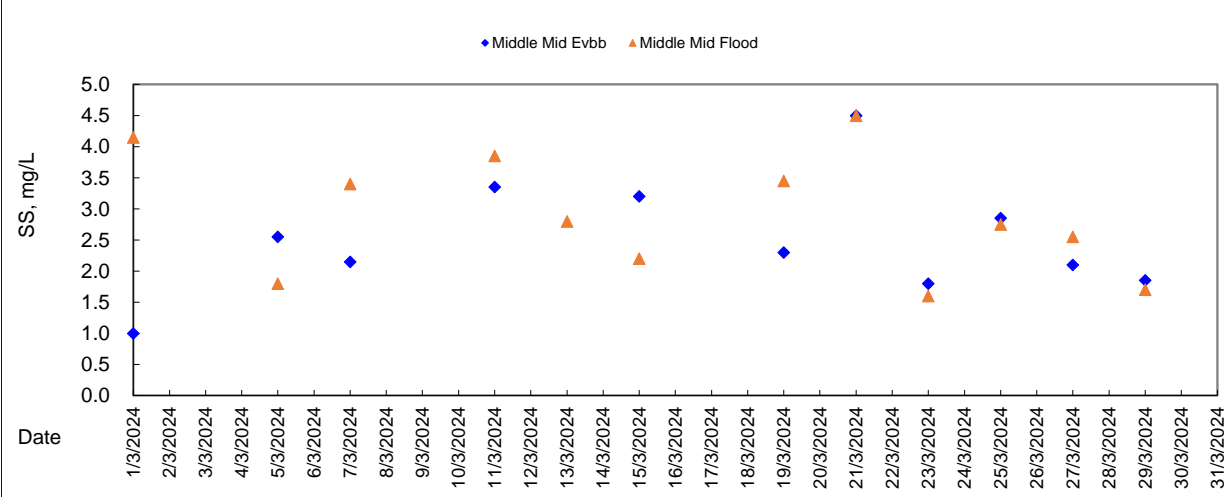



Graphic Presentation of WQM Result

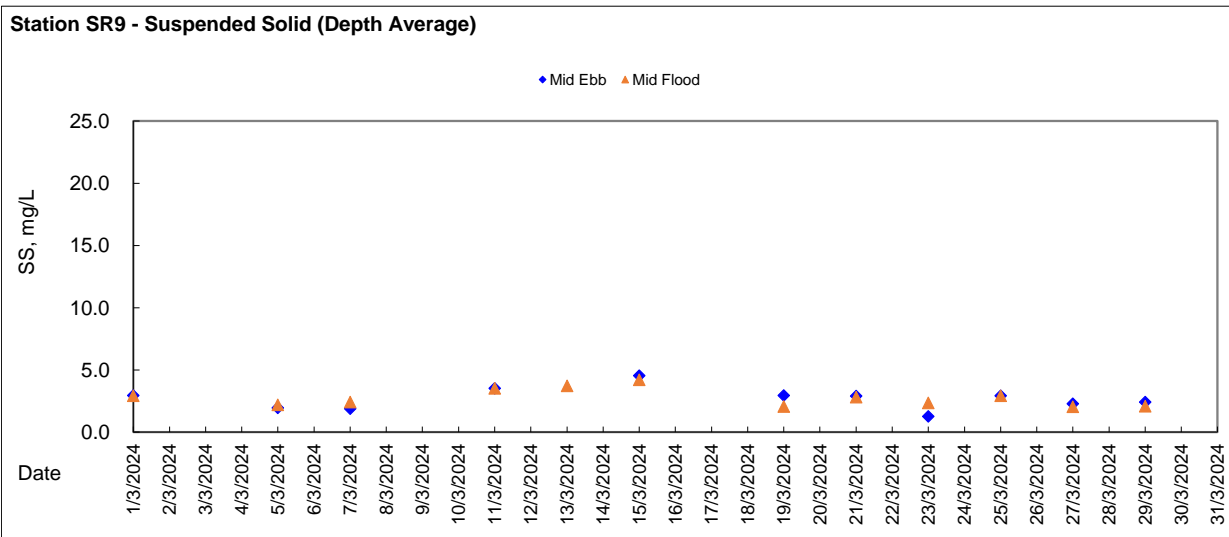
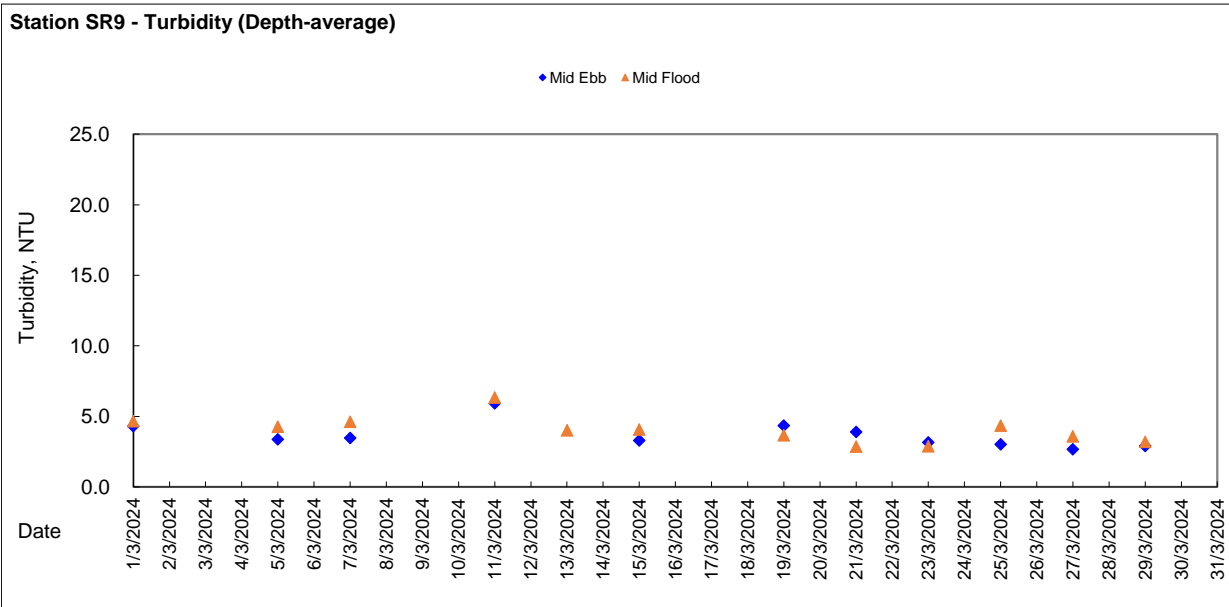
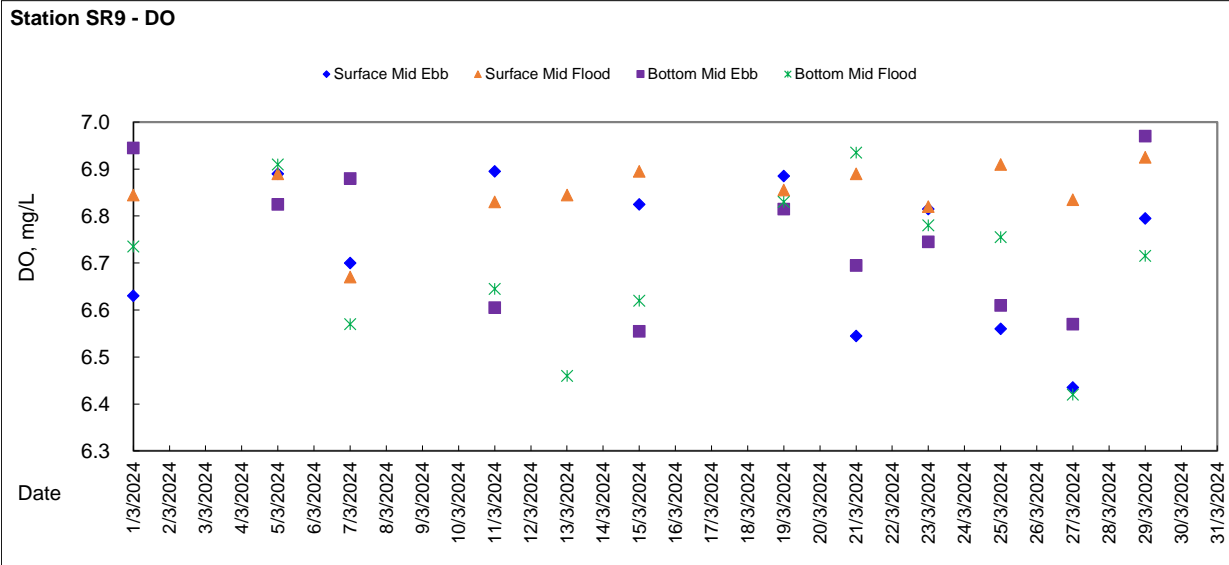



Graphic Presentation of WQM Result

Station SR10 - DO

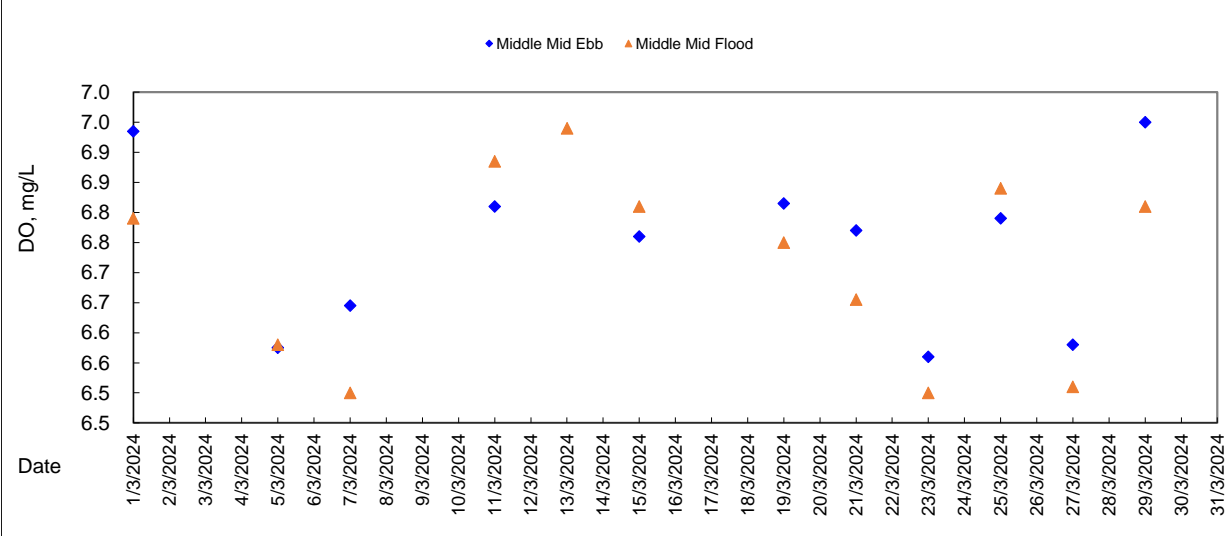

Station SR10 - Turbidity (Depth-average)

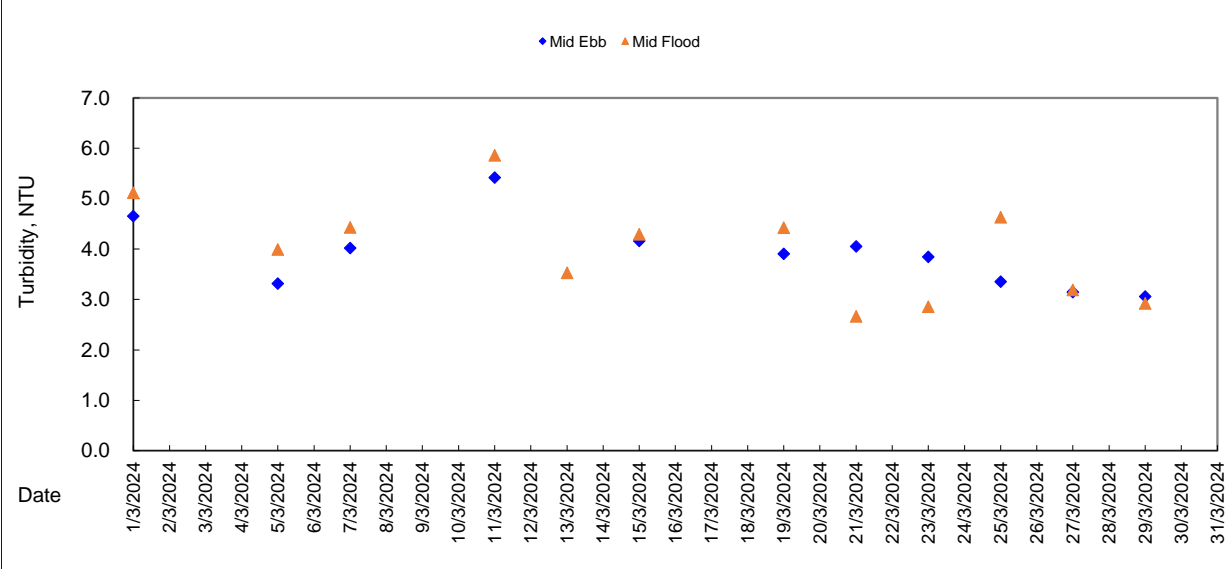

Station SR10 - Suspended Solid (Depth-average)

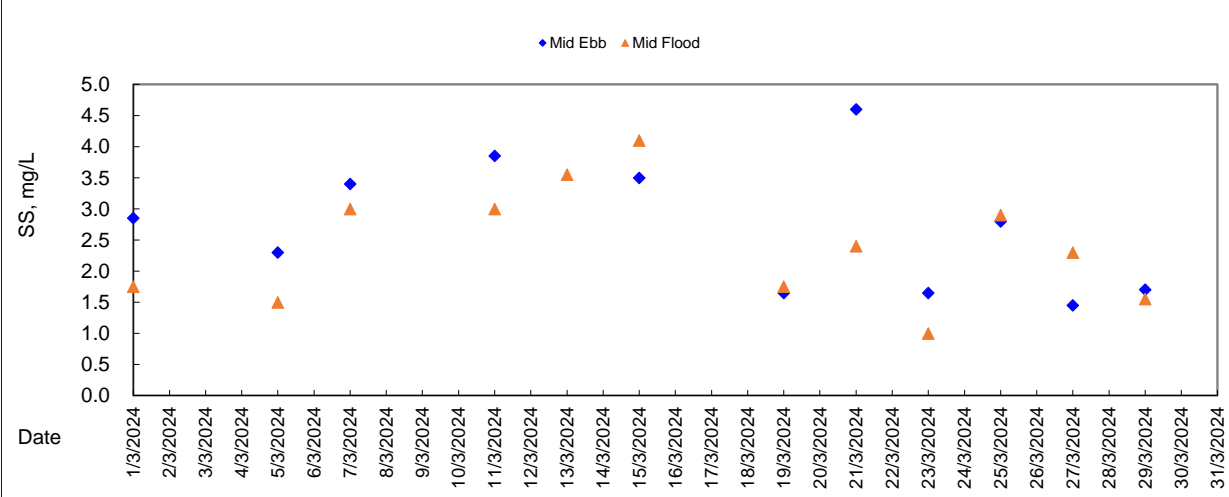



Graphic Presentation of WQM Result

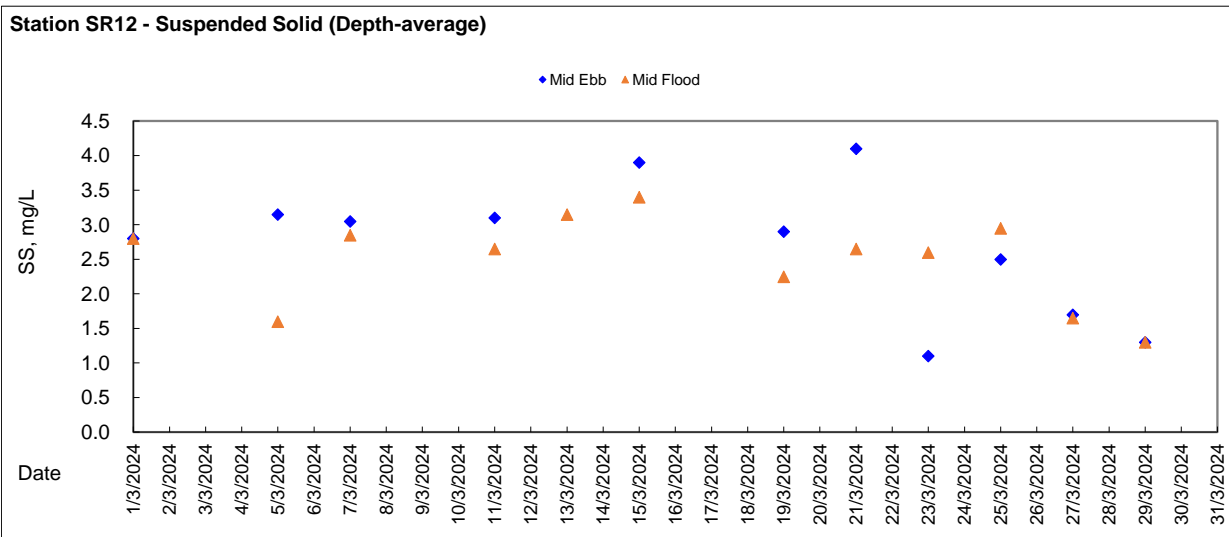
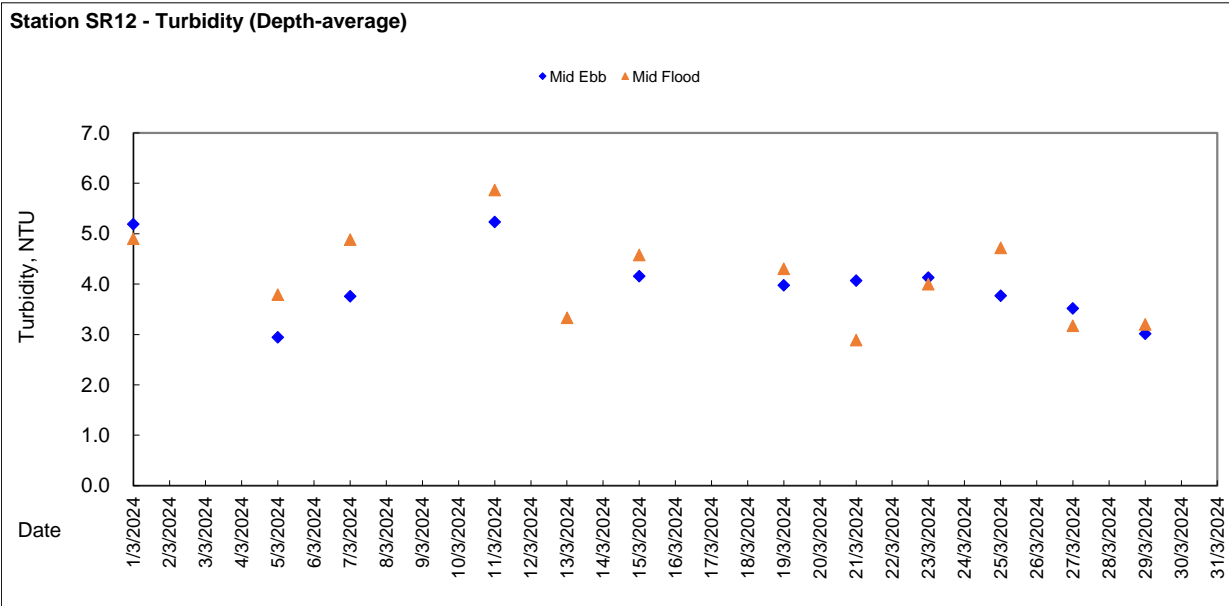
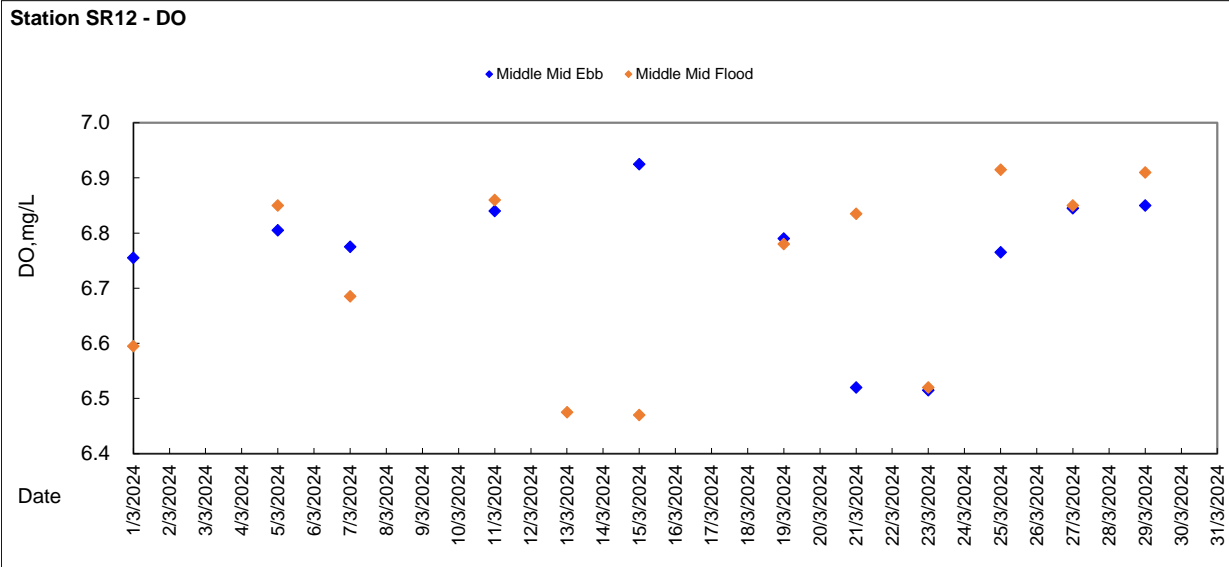



Graphic Presentation of WQM Result

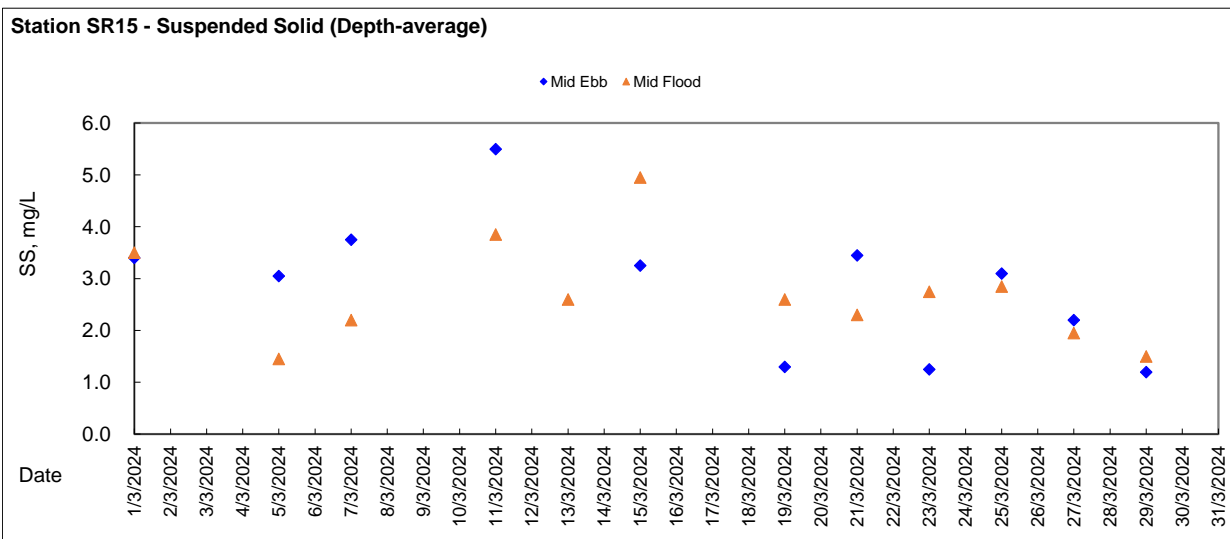
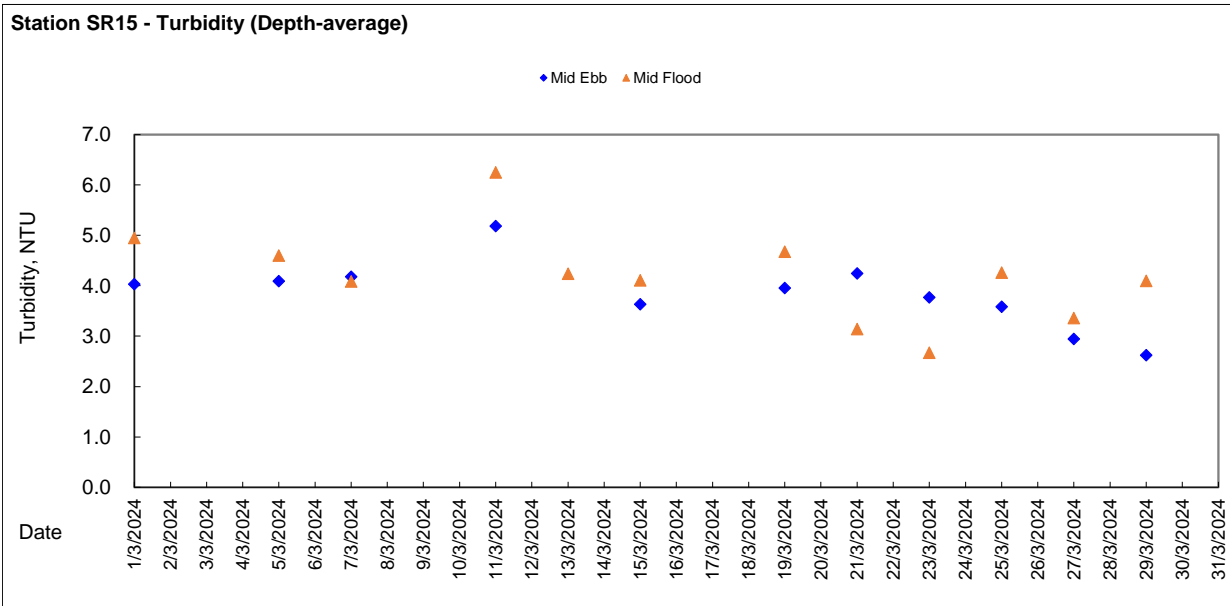
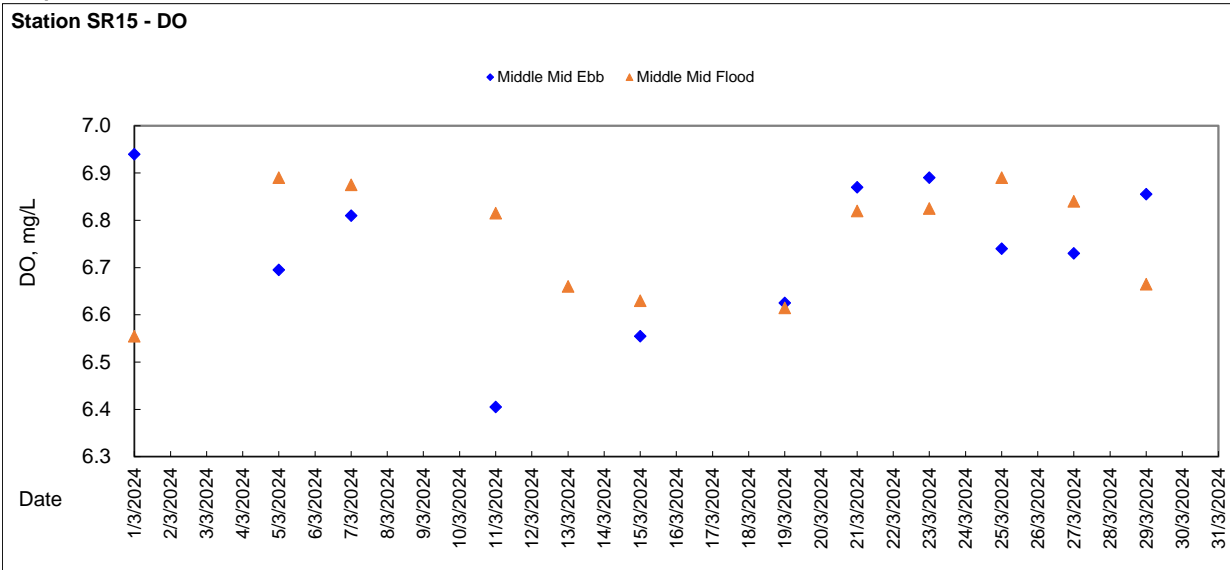



Impact Water Quality Monitoring at Station SR4 (surface) - Ebb Tide

Station Reference	Sampling Date	Weather	Sampling Time	Water Depth m	Sampling Depth m	Temperature °C		pH		Salinity ppt		DO Saturation %		DO mg/L		Turbidity NTU		SS mg/L			
						Value	AVG	Value	AVG	Value	AVG	Value	AVG	Value	AVG	Value	AVG	Value	AVG	Value	AVG
						WQM was cancelled due to adverse weather															
SR4	1/3/2024	Cloudy	15:38	3.8	1.0	18.37	18.33	8.62	8.58	32.63	32.59	86.60	86.95	6.77	6.80	4.04	4.09	1.9	1.9		
			15:39	3.8	1.0	18.28	18.33	8.53	8.58	32.55	32.59	87.30	86.95	6.83	6.80	4.13	4.09	1.8	1.9		
	5/3/2024	Cloudy	18:33	3.8	1.0	20.49	20.43	8.51	8.50	32.56	32.52	91.00	90.60	6.78	6.74	3.67	3.92	3.2	3.0		
			18:34	3.8	1.0	20.36	20.43	8.49	8.50	32.47	32.52	90.20	90.60	6.70	6.74	3.87	3.92	2.5	3.0		
	7/3/2024	Cloudy	9:57	3.2	1.0	21.22	21.22	8.69	8.70	32.41	32.40	87.60	86.65	6.63	6.60	3.36	3.27	3.4	3.3		
			9:58	3.2	1.0	21.21	21.22	8.70	8.70	32.39	32.40	85.70	86.65	6.56	6.60	3.18	3.27	3.1	3.3		
	9/3/2024	Strong Mansoon	WQM was cancelled due to adverse weather																		
	11/3/2024	Cloudy	13:07	3.5	1.0	19.09	19.18	8.58	8.59	32.58	32.53	82.80	82.20	6.56	6.53	5.37	5.50	4.6	4.2		
			13:08	3.5	1.0	19.27	19.18	8.59	8.59	32.48	32.53	81.60	82.20	6.49	6.53	5.62	5.50	3.8	4.2		
	13/3/2024	Strong Mansoon	WQM was cancelled due to adverse weather																		
	15/3/2024	Cloudy	16:01	3.7	1.0	20.11	20.14	8.34	8.34	32.56	32.52	89.10	89.40	6.77	6.80	3.54	3.61	5.1	5.1		
			16:02	3.7	1.0	20.17	20.14	8.34	8.34	32.48	32.52	89.70	89.40	6.82	6.80	3.67	3.61	5.0	5.1		
	19/3/2024	Fine	18:47	3.8	1.0	20.91	20.95	8.53	8.54	32.27	32.32	90.40	90.60	6.71	6.74	3.38	3.48	1.7	1.8		
			19:48	3.8	1.0	20.98	20.95	8.55	8.54	32.37	32.32	90.80	90.60	6.76	6.74	3.57	3.48	1.9	1.8		
	21/3/2024	Cloudy	10:47	3.5	1.0	21.16	21.17	8.70	8.70	32.13	32.11	91.60	92.00	6.60	6.84	3.67	3.57	2.0	3.1		
			10:48	3.5	1.0	21.18	21.17	8.69	8.70	32.08	32.11	92.40	92.00	6.57	6.84	3.46	3.57	3.2	3.1		
	23/3/2024	Cloudy	11:33	3.6	1.0	21.47	21.49	8.56	8.57	32.20	32.16	91.40	91.05	6.69	6.68	3.87	3.79	1.3	1.6		
			11:34	3.6	1.0	21.51	21.49	8.57	8.57	32.12	32.16	90.70	91.05	6.66	6.68	3.70	3.79	1.8	1.6		
	25/3/2024	Cloudy	11:57	3.2	1.0	21.95	21.90	8.41	8.41	31.74	31.67	87.70	87.50	6.55	6.51	2.47	2.35	2.9	2.7		
			11:58	3.2	1.0	21.84	21.90	8.41	8.41	31.60	31.67	87.30	87.50	6.46	6.51	2.22	2.35	2.4	2.7		
	27/3/2024	Cloudy	13:28	3.7	1.0	23.09	23.11	8.36	8.37	30.25	30.14	88.30	88.15	6.78	6.78	3.25	3.17	3.7	3.6		
			13:29	3.7	1.0	23.12	23.11	8.37	8.37	30.02	30.14	88.00	88.15	6.77	6.78	3.08	3.17	3.5	3.6		
	29/3/2024	Cloudy	14:33	3.7	1.0	23.09	23.02	8.28	8.28	31.00	31.16	91.40	90.90	6.96	6.92	3.68	3.64	1.8	1.7		
			14:34	3.7	1.0	22.94	23.02	8.28	8.28	31.32	31.16	90.40	90.90	6.87	6.92	3.59	3.64	1.6	1.7		

General Note: For calculation of average concentration of SS, the minimum value for "NOT DETECTED" is treated as 1.0mg/L according to reporting limit.



Impact Water Quality Monitoring at Station SR4 (surface) - Flood Tide

Station Reference	Sampling Date	Weather	Sampling Time	Water Depth m	Sampling Depth m	Temperature °C		pH		Salinity ppt		DO Saturation %		DO mg/L		Turbidity NTU		SS mg/L			
						Value	AVG	Value	AVG	Value	AVG	Value	AVG	Value	AVG	Value	AVG	Value	AVG	Value	AVG
						WQM was cancelled due to adverse weather															
SR4	1/3/2024	Cloudy	9:00	3.3	1.0	18.07	18.13	8.60	8.62	32.16	32.23	85.00	85.50	6.58	6.62	4.67	4.61	3.0	3.0		
			9:01	3.3	1.0	18.19	18.13	8.63	8.62	32.27	32.23	86.00	85.50	6.65	6.62	4.55	4.61	2.9	3.0		
	5/3/2024	Cloudy	8:03	3.2	1.0	20.42	20.40	8.54	8.57	32.74	32.70	92.30	93.00	6.88	6.94	4.95	4.89	2.3	2.2		
			8:04	3.2	1.0	20.38	20.40	8.60	8.57	32.65	32.70	93.70	93.00	6.99	6.94	4.83	4.89	2.1	2.2		
	7/3/2024	Cloudy	15:04	3.3	1.0	20.75	20.70	8.42	8.39	32.79	32.82	84.40	84.15	6.58	6.53	4.44	4.50	4.0	3.8		
			15:05	3.3	1.0	20.64	20.70	8.36	8.39	32.84	32.82	83.90	84.15	6.48	6.53	4.56	4.50	3.6	3.8		
	9/3/2024	Strong Mansoon	WQM was cancelled due to adverse weather																		
	11/3/2024	Cloudy	7:22	3.2	1.0	18.99	18.98	8.57	8.59	32.84	32.90	87.70	88.20	6.85	6.88	7.85	7.75	3.7	4.0		
			7:23	3.2	1.0	18.97	18.98	8.60	8.59	32.95	32.90	88.70	88.20	6.90	6.88	7.64	7.75	4.2	4.0		
	13/3/2024	Cloudy	8:08	3.4	1.0	19.72	19.66	8.42	8.42	32.84	32.81	91.80	91.65	6.90	6.89	5.02	4.91	2.4	2.4		
			8:09	3.4	1.0	19.60	19.66	8.42	8.42	32.77	32.81	91.50	91.65	6.88	6.89	4.79	4.91	2.4	2.4		
	15/3/2024	Cloudy	8:58	3.2	1.0	20.24	20.21	8.53	8.53	32.41	32.47	87.10	87.55	6.85	6.88	4.81	4.88	4.6	4.5		
			8:59	3.2	1.0	20.18	20.21	8.52	8.53	32.53	32.47	88.00	87.55	6.91	6.88	4.94	4.88	4.4	4.5		
	19/3/2024	Fine	8:31	3.4	1.0	20.92	20.83	8.52	8.53	31.85	31.90	89.30	89.70	6.75	6.78	4.76	4.80	2.3	2.2		
			8:32	3.4	1.0	20.74	20.83	8.53	8.53	31.94	31.90	90.10	89.70	6.80	6.78	4.84	4.80	2.0	2.2		
	21/3/2024	Cloudy	16:04	3.7	1.0	20.69	20.70	8.61	8.61	32.65	32.72	89.30	89.10	6.84	6.80	3.37	3.19	2.5	2.6		
			16:05	3.7	1.0	20.70	20.70	8.61	8.61	32.79	32.72	88.90	89.10	6.76	6.80	3.00	3.19	2.6	2.6		
	23/3/2024	Cloudy	17:32	3.7	1.0	21.97	22.03	8.62	8.62	32.02	32.10	87.60	87.35	6.52	6.51	2.95	2.84	2.4	2.0		
			17:33	3.7	1.0	22.09	22.03	8.62	8.62	32.18	32.10	87.10	87.35	6.49	6.51	2.73	2.84	1.5	2.0		
	25/3/2024	Cloudy	18:54	3.0	1.0	21.56	21.62	8.34	8.34	31.74	31.64	85.20	85.75	6.69	6.74	4.05	3.95	3.6	3.0		
			18:55	3.0	1.0	21.67	21.62	8.33	8.34	31.53	31.64	86.30	85.75	6.78	6.74	3.84	3.95	2.3	3.0		
	27/3/2024	Cloudy	7:19	3.4	1.0	23.30	23.29	8.51	8.52	30.87	30.81	88.60	88.05	6.78	6.75	4.01	4.00	2.6	2.6		
			7:20	3.4	1.0	23.27	23.29	8.52	8.52	30.74	30.81	87.50	88.05	6.71	6.75	3.98	4.00	2.6	2.6		
	29/3/2024	Cloudy	7:51	3.2	1.0	23.37	23.26	8.42	8.42	31.42	31.41	87.10	87.40	6.74	6.77	4.01	3.98	1.6	1.6		
			7:52	3.2	1.0	23.14	23.26	8.42	8.42	31.39	31.41	87.70	87.40	6.79	6.77	3.94	3.98	1.5	1.6		

General Note: For calculation of average concentration of SS, the minimum value for "NOT DETECTED" is treated as 1.0mg/L according to reporting limit.



Impact Water Quality Monitoring at Station SR4 (Bottom) - Ebb Tide

Station Reference	Sampling Date	Weather	Sampling Time	Water Depth m	Sampling Depth m	Temperature °C		pH		Salinity ppt		DO Saturation %		DO mg/L		Turbidity NTU		SS mg/L			
						Value	AVG	Value	AVG	Value	AVG	Value	AVG	Value	AVG	Value	AVG	Value	AVG	Value	AVG
						°C															
SR4	1/3/2024	Cloudy	15:40	3.8	2.8	18.56	18.49	8.59	8.58	32.94	32.90	89.80	89.10	6.97	6.92	4.53	4.39	2.2	2.1		
			15:41	3.8	2.8	18.42	8.57	32.86	89.40	6.86	4.25	2.0									
	5/3/2024	Cloudy	18:35	3.8	2.8	20.31	20.40	8.59	8.52	32.76	32.79	90.00	90.45	6.69	6.73	3.12	3.02	2.4	2.3		
			18:36	3.8	2.8	20.48	8.51	32.81	90.90	6.76	2.92	2.1									
	7/3/2024	Cloudy	9:59	3.2	2.2	21.15	21.12	8.73	8.73	32.50	32.49	90.50	91.10	6.82	6.85	3.70	3.82	2.9	2.8		
			10:00	3.2	2.2	21.08	8.72	32.48	91.70	6.87	3.94	2.6									
	9/3/2024	Strong Mansoon	WQM was cancelled due to adverse weather																		
	11/3/2024	Cloudy	13:09	3.5	2.5	19.20	19.17	8.61	8.60	32.80	32.75	89.50	89.25	6.83	6.82	5.17	5.13	3.6	3.9		
			13:10	3.5	2.5	19.13	8.59	32.70	89.00	6.80	5.08	4.1									
	13/3/2024	Strong Mansoon	WQM was cancelled due to adverse weather																		
	15/3/2024	Cloudy	16:03	3.8	2.7	20.15	20.17	8.32	8.33	32.57	33.50	83.30	83.80	6.41	6.44	3.84	3.76	5.4	5.6		
			16:04	3.7	2.7	20.19	8.33	34.42	84.30	6.47	3.67	5.7									
	19/3/2024	Fine	18:49	3.8	2.8	20.96	20.92	8.55	8.55	32.41	32.39	91.40	91.50	6.77	6.79	3.74	3.65	3.3	3.2		
			19:50	3.8	2.8	20.87	8.54	32.36	91.60	6.80	3.56	3.0									
	21/3/2024	Cloudy	10:49	3.5	2.5	21.14	21.17	8.67	8.68	32.19	32.24	84.20	84.55	6.41	6.43	3.25	3.42	4.4	4.3		
			10:50	3.5	2.5	21.19	8.68	32.28	84.90	6.45	3.59	4.2									
	23/3/2024	Cloudy	11:35	3.6	2.6	22.26	22.32	8.59	8.59	32.06	32.11	89.20	89.45	6.58	6.60	3.90	4.01	2.0	2.2		
			11:36	3.6	2.6	22.37	8.59	32.16	89.70	6.62	4.12	2.4									
	25/3/2024	Cloudy	11:59	3.2	2.2	21.73	21.80	8.41	8.41	31.56	31.50	89.00	89.15	6.77	6.78	2.80	2.89	2.0	2.2		
			12:00	3.2	2.2	21.87	8.40	31.43	89.30	6.78	2.98	2.4									
	27/3/2024	Cloudy	13:30	3.7	2.7	23.18	23.15	8.37	8.37	31.27	31.32	81.60	82.35	6.43	6.48	2.91	2.97	2.7	2.8		
			13:31	3.7	2.7	23.12	8.36	31.37	83.10	6.53	3.02	2.9									
	29/3/2024	Cloudy	14:35	3.7	2.7	23.00	22.96	8.27	8.28	31.25	31.37	87.60	87.00	6.62	6.58	2.91	2.98	2.3	2.3		
			14:36	3.7	2.7	22.91	8.28	31.49	86.40	6.54	3.04	2.2									

General Note: For calculation of average concentration of SS, the minimum value for "NOT DETECTED" is treated as 1.0mg/L according to reporting limit.



Impact Water Quality Monitoring at Station SR4 (Bottom) - Flood Tide

Station Reference	Sampling Date	Weather	Sampling Time	Water Depth m	Sampling Depth m	Temperature °C		pH		Salinity ppt		DO Saturation %		DO mg/L		Turbidity NTU		SS mg/L		
						Value	AVG	Value	AVG	Value	AVG	Value	AVG	Value	AVG	Value	AVG	Value	AVG	
						°C														
SR4	1/3/2024	Cloudy	9:02	3.3	2.3	18.27	18.22	8.60	8.59	32.36	32.32	83.60	84.00	6.49	6.52	5.27	5.33	4.2	4.4	
			9:03	3.3	2.3	18.16	8.57	32.27	84.40	6.45	5.38	4.5								
	5/3/2024	Cloudy	8:05	3.2	2.2	20.31	20.34	8.63	8.62	32.16	32.22	93.10	92.45	6.95	6.90	4.61	4.67	1.6	1.5	
			8:06	3.2	2.2	20.37	8.60	32.27	91.80	6.84	4.72	1.4								
	7/3/2024	Cloudy	15:06	3.3	2.3	20.74	20.75	8.39	8.41	32.56	32.50	89.80	89.20	6.90	6.89	5.04	5.00	2.4	2.3	
			15:07	3.3	2.3	20.75	8.43	32.43	88.60	6.88	4.96	2.1								
	9/3/2024	Strong Mansoon	WQM was cancelled due to adverse weather																	
	11/3/2024	Cloudy	7:24	3.2	2.2	19.01	19.09	8.58	8.58	33.64	33.51	82.70	83.45	6.49	6.52	7.32	7.40	3.7	3.5	
			7:25	3.2	2.2	19.17	8.58	33.37	84.20	6.55	7.47	3.3								
	13/3/2024	Cloudy	8:10	3.4	2.4	19.60	19.58	8.40	8.41	33.14	33.12	89.50	90.20	6.75	6.80	3.67	3.60	3.0	3.2	
			8:11	3.4	2.4	19.56	8.41	33.10	90.90	6.85	3.52	3.4								
	15/3/2024	Cloudy	9:00	3.2	2.2	20.17	20.16	8.54	8.54	32.49	32.50	85.60	85.35	6.59	6.58	3.87	3.78	3.6	3.5	
			9:01	3.2	2.2	20.14	8.53	32.50	85.10	6.56	3.69	3.4								
	19/3/2024	Fine	8:33	3.4	2.4	20.82	20.82	8.52	8.52	32.10	32.08	91.60	91.20	6.88	6.85	3.78	3.90	4.2	4.0	
			8:34	3.4	2.4	20.82	8.52	32.06	90.80	6.82	4.01	3.8								
	21/3/2024	Cloudy	16:06	3.7	2.7	20.72	20.69	8.60	8.60	32.73	32.66	85.00	84.90	6.69	6.66	3.40	3.26	3.7	3.5	
			16:07	3.7	2.7	20.65	8.60	32.59	84.80	6.62	3.12	3.3								
	23/3/2024	Cloudy	17:34	3.7	2.7	22.01	21.89	8.62	8.63	31.96	32.00	89.60	88.40	6.76	6.72	3.28	3.34	1.1	1.5	
			17:35	3.7	2.7	21.77	8.63	32.04	87.20	6.67	3.40	1.8								
	25/3/2024	Cloudy	18:56	3.0	2.0	21.63	21.69	8.34	8.34	31.64	31.62	84.80	85.15	6.66	6.69	4.16	4.27	2.3	2.4	
			18:57	3.0	2.0	21.74	8.34	31.60	85.50	6.71	4.37	2.4								
	27/3/2024	Cloudy	7:21	3.4	2.4	23.20	23.30	8.52	8.51	30.64	30.70	88.20	87.95	6.76	6.73	4.25	4.14	2.3	2.2	
			7:22	3.4	2.4	23.40	8.50	30.75	87.70	6.69	4.02	2.1								
	29/3/2024	Cloudy	7:53	3.2	2.2	23.08	23.02	8.43	8.43	31.25	31.22	86.10	84.85	6.65	6.72	4.41	4.49	1.1	1.2	
7:54			3.2	2.2	22.95	8.42	31.19	83.60	6.79	4.56	1.2									

General Note: For calculation of average concentration of SS, the minimum value for "NOT DETECTED" is treated as 1.0mg/L according to reporting limit.



Impact Water Quality Monitoring at Station SR5 (surface) - Ebb Tide

Station Reference	Sampling Date	Weather	Sampling Time	Water Depth m	Sampling Depth m	Temperature °C		pH		Salinity ppt		DO Saturation %		DO mg/L		Turbidity NTU		SS mg/L			
						Value	AVG	Value	AVG	Value	AVG	Value	AVG	Value	AVG	Value	AVG	Value	AVG	Value	AVG
						°C															
SR5	1/3/2024	Cloudy	15:29	4.3	1.0	18.32	18.37	8.43	8.49	32.87	32.83	86.10	86.35	6.65	6.67	4.09	4.11	2.6	2.7		
			15:30	4.3	1.0	18.42		8.55		32.79		86.60		6.69		4.13		2.8			
	5/3/2024	Cloudy	18:24	4.3	1.0	20.43	20.40	8.50	8.51	32.87	32.84	89.30	89.40	6.60	6.63	3.19	3.22	3.3	3.1		
			18:25	4.3	1.0	20.38		8.52		32.81		89.50		6.65		3.25		2.9			
	7/3/2024	Cloudy	10:07	4.0	1.0	21.03	21.06	8.73	8.72	32.75	32.75	87.00	87.30	6.52	6.54	4.37	4.29	2.8	2.8		
			10:08	4.0	1.0	21.09		8.70		32.74		87.60		6.55		4.21		2.7			
	9/3/2024	Strong Mansoon	WQM was cancelled due to adverse weather																		
	11/3/2024	Cloudy	12:58	4.1	1.0	19.18	19.12	8.60	8.60	32.59	32.53	80.70	81.40	6.40	6.44	4.97	4.99	4.2	4.0		
			12:59	4.1	1.0	19.06		8.60		32.47		82.10		6.48		5.00		3.8			
	13/3/2024	Strong Mansoon	WQM was cancelled due to adverse weather																		
	15/3/2024	Cloudy	15:52	4.4	1.0	20.04	20.06	8.34	8.34	32.63	32.61	83.80	84.35	6.56	6.58	3.54	3.43	5.1	5.0		
			15:53	4.3	1.0	20.08		8.33		32.59		84.90		6.60		3.32		4.8			
	19/3/2024	Fine	18:38	4.4	1.0	20.86	20.91	8.53	8.54	32.37	32.32	89.20	89.10	6.84	6.84	3.04	3.12	4.0	3.9		
			18:39	4.4	1.0	20.95		8.54		32.26		89.00		6.83		3.19		3.8			
	21/3/2024	Cloudy	10:56	4.0	1.0	21.27	21.22	8.70	8.70	32.49	32.35	89.60	88.50	6.83	6.79	3.90	4.04	2.9	3.1		
			10:57	4.0	1.0	21.16		8.69		32.21		87.40		6.75		4.17		3.2			
	23/3/2024	Cloudy	11:43	4.0	1.0	22.19	22.27	8.61	8.61	32.09	32.03	88.40	88.80	6.76	6.81	3.25	3.16	1.5	1.5		
			11:44	4.0	1.0	22.35		8.60		31.97		89.20		6.85		3.06		1.5			
	25/3/2024	Cloudy	12:06	4.1	1.0	-	22.01	8.42	8.42	31.44	31.41	89.20	89.00	6.64	6.62	3.37	3.24	1.6	1.8		
			12:07	4.1	1.0	22.01		8.41		31.37		88.80		6.60		3.11		2.0			
	27/3/2024	Cloudy	13:18	4.3	1.0	23.30	23.29	8.39	8.39	31.36	31.32	88.30	88.70	6.68	6.71	2.47	2.36	3.8	3.6		
			13:19	4.3	1.0	23.28		8.38		31.27		89.10		6.74		2.24		3.4			
	29/3/2024	Cloudy	14:23	4.2	1.0	22.65	22.73	8.27	8.27	31.09	31.17	83.90	86.25	6.54	6.68	3.14	3.10	2.6	2.7		
			14:24	4.2	1.0	22.80		8.27		31.25		88.60		6.82		3.05		2.8			

General Note: For calculation of average concentration of SS, the minimum value for "NOT DETECTED" is treated as 1.0mg/L according to reporting limit.



Impact Water Quality Monitoring at Station SR5 (surface) - Flood Tide

Station Reference	Sampling Date	Weather	Sampling Time	Water Depth m	Sampling Depth m	Temperature °C		pH		Salinity ppt		DO Saturation %		DO mg/L		Turbidity NTU		SS mg/L			
						Value	AVG	Value	AVG	Value	AVG	Value	AVG	Value	AVG	Value	AVG	Value	AVG		
						°C															
SR5	1/3/2024	Cloudy	9:09	4.0	1.0	18.04	18.10	8.61	8.63	32.60	32.55	87.50	87.60	6.71	6.72	4.79	4.87	3.9	4.0		
			9:10	4.0	1.0	18.16		8.64		32.49		87.70		6.72		4.94		4.0			
	5/3/2024	Cloudy	8:13	3.8	1.0	20.34	20.31	8.62	8.61	32.76	32.80	91.30	92.00	6.60	6.85	4.25	4.34	1.6	1.7		
			8:14	3.8	1.0	20.28		8.59		32.84		92.70		6.90		4.43		1.8			
	7/3/2024	Cloudy	14:55	4.1	1.0	20.84	20.79	8.42	8.43	33.12	33.08	90.00	89.80	6.83	6.80	4.36	4.31	2.8	2.7		
			14:56	4.1	1.0	20.74		8.43		33.03		89.60		6.77		4.25		2.5			
	9/3/2024	Strong Mansoon	WQM was cancelled due to adverse weather																		
	11/3/2024	Cloudy	7:31	3.9	1.0	19.10	19.07	8.55	8.56	32.90	32.94	87.30	87.85	6.77	6.80	7.09	7.13	2.9	2.7		
			7:32	3.9	1.0	19.03		8.56		32.97		88.40		6.82		7.17		2.5			
	13/3/2024	Cloudy	8:18	4.0	1.0	19.47	19.49	8.43	8.43	32.90	32.88	89.00	89.60	6.69	6.75	4.26	4.32	2.5	2.7		
			8:19	4.0	1.0	19.50		8.42		32.86		90.20		6.80		4.37		2.8			
	15/3/2024	Cloudy	9:07	3.8	1.0	20.12	20.10	8.50	8.51	32.38	32.43	88.30	89.50	6.82	6.88	4.04	4.01	2.5	2.4		
			9:08	3.8	1.0	20.08		8.51		32.48		90.70		6.94		3.97		2.3			
	19/3/2024	Fine	8:40	3.9	1.0	20.77	20.75	8.53	8.54	32.00	32.04	86.20	87.45	6.62	6.75	3.47	3.39	4.1	4.3		
			8:41	3.9	1.0	20.73		8.54		32.07		88.70		6.67		3.31		4.5			
	21/3/2024	Cloudy	15:54	4.3	1.0	20.64	20.69	8.63	8.63	32.64	32.70	89.50	88.40	6.85	6.79	2.37	2.50	3.5	3.7		
			15:55	4.3	1.0	20.74		8.62		32.75		87.30		6.72		2.63		3.9			
	23/3/2024	Cloudy	17:24	4.2	1.0	21.90	22.04	8.63	8.63	32.24	32.17	88.40	89.20	6.73	6.78	2.87	2.82	2.3	1.9		
			17:25	4.2	1.0	22.17		8.63		32.10		90.00		6.82		2.76		1.5			
	25/3/2024	Cloudy	18:45	3.7	1.0	21.80	21.73	8.31	8.32	31.36	31.43	84.20	85.25	6.59	6.66	3.38	3.47	2.4	2.6		
			18:46	3.7	1.0	21.66		8.33		31.50		86.30		6.72		3.56		2.8			
	27/3/2024	Cloudy	7:29	4.0	1.0	23.24	23.27	8.50	8.50	30.95	30.90	81.30	81.00	6.48	6.47	4.18	4.15	1.8	1.9		
			7:30	4.0	1.0	23.29		8.50		30.84		80.70		6.45		4.12		1.9			
	29/3/2024	Cloudy	8:01	3.7	1.0	23.25	23.14	8.42	8.42	31.46	31.40	82.00	85.20	6.65	6.76	3.89	3.95	1.2	1.2		
8:02			3.7	1.0	23.02		8.41		31.34		88.40		6.86		4.00		1.1				

General Note: For calculation of average concentration of SS, the minimum value for "NOT DETECTED" is treated as 1.0mg/L according to reporting limit.



Impact Water Quality Monitoring at Station SR5 (Bottom) - Ebb Tide

Station Reference	Sampling Date	Weather	Sampling Time	Water Depth m	Sampling Depth m	Temperature °C		pH		Salinity ppt		DO Saturation %		DO mg/L		Turbidity NTU		SS mg/L			
						Value	AVG	Value	AVG	Value	AVG	Value	AVG	Value	AVG	Value	AVG	Value	AVG	Value	AVG
						WQM was cancelled due to adverse weather															
SR5	1/3/2024	Cloudy	15:31	4.3	3.3	18.23		8.42	8.49	32.49	32.56	87.70	87.40	6.79	6.77	4.02	4.00	2.0	2.2		
			15:32	4.3	3.3	18.38	18.31	8.56	8.54	32.63	32.56	87.10	87.40	6.74	6.77	3.98	4.00	2.3	2.3		
	5/3/2024	Cloudy	18:27	4.3	3.3	20.46	20.49	8.54	8.54	32.70	32.63	90.80	90.35	6.75	6.72	3.41	3.31	3.7	3.8		
			18:28	4.3	3.3	20.51		8.54	8.54	32.56	32.56	89.90	89.90	6.68	6.68	3.21	3.21	3.9	3.9		
	7/3/2024	Cloudy	10:10	4.0	3.0	21.04	21.02	8.73	8.72	32.94	32.88	91.30	91.85	6.91	6.93	3.73	3.88	2.5	2.4		
			10:11	4.0	3.0	20.99		8.70	8.70	32.81	32.81	92.40	92.40	6.94	6.94	4.02	4.02	2.2	2.2		
	9/3/2024	Strong Mansoon	WQM was cancelled due to adverse weather																		
	11/3/2024	Cloudy	13:01	4.1	3.1	19.25	19.17	8.59	8.60	32.50	32.53	86.70	86.40	6.80	6.78	4.85	4.81	4.4	4.6		
			13:02	4.1	3.1	19.08		8.61	8.61	32.56	32.56	86.10	86.10	6.76	6.76	4.76	4.76	4.8	4.8		
	13/3/2024	Strong Mansoon	WQM was cancelled due to adverse weather																		
	15/3/2024	Cloudy	15:55	4.4	3.3	20.06	20.08	8.34	8.35	32.49	32.50	84.40	84.65	6.53	6.56	3.50	3.59	4.0	4.2		
			15:56	4.3	3.3	20.10		8.35	8.35	32.50	32.50	84.90	84.90	6.58	6.58	3.67	3.67	4.4	4.4		
	19/3/2024	Fine	18:40	4.4	3.4	20.99	20.98	8.52	8.53	32.41	32.37	89.80	88.90	6.80	6.55	3.41	3.33	2.9	2.8		
			19:41	4.4	3.4	20.97		8.53	8.53	32.33	32.33	88.00	88.00	6.49	6.49	3.25	3.25	2.6	2.6		
	21/3/2024	Cloudy	10:59	4.0	3.0	21.28	21.20	8.70	8.70	32.19	32.21	89.00	88.30	6.71	6.68	4.02	3.95	3.8	4.0		
			11:00	4.0	3.0	21.11		8.70	8.70	32.23	32.21	87.60	88.30	6.65	6.68	3.87	3.95	4.1	4.1		
	23/3/2024	Cloudy	11:46	4.0	3.0	22.27	22.23	8.60	8.61	32.16	32.09	92.30	92.95	6.81	6.85	2.67	2.86	2.0	1.7		
			11:47	4.0	3.0	22.18		8.61	8.61	32.01	32.09	93.60	93.60	6.88	6.85	3.04	3.04	1.3	1.3		
	25/3/2024	Cloudy	12:08	4.1	3.1	21.93	21.91	8.42	8.42	31.67	31.62	85.00	84.85	6.40	6.39	2.69	2.77	2.6	2.3		
			12:09	4.1	3.1	21.89		8.42	8.42	31.56	31.62	84.70	84.70	6.38	6.38	2.84	2.84	2.0	2.0		
	27/3/2024	Cloudy	13:20	4.3	3.3	23.27	23.21	8.38	8.38	31.19	31.11	84.20	83.50	6.40	6.38	2.73	2.84	2.8	3.0		
			13:21	4.3	3.3	23.15		8.38	8.38	31.02	31.11	82.80	83.50	6.36	6.38	2.94	2.84	3.1	3.1		
	29/3/2024	Cloudy	14:25	4.2	3.2	22.61	22.55	8.28	8.28	31.15	31.13	90.00	88.45	6.87	6.79	3.01	2.95	2.5	2.4		
			14:26	4.2	3.2	22.48		8.28	8.28	31.10	31.13	86.90	88.45	6.70	6.79	2.89	2.89	2.2	2.2		

General Note: For calculation of average concentration of SS, the minimum value for "NOT DETECTED" is treated as 1.0mg/L according to reporting limit.



Impact Water Quality Monitoring at Station SR5 (Bottom) - Flood Tide

Station Reference	Sampling Date	Weather	Sampling Time	Water Depth m	Sampling Depth m	Temperature °C		pH		Salinity ppt		DO Saturation %		DO mg/L		Turbidity NTU		SS mg/L			
						Value	AVG	Value	AVG	Value	AVG	Value	AVG	Value	AVG	Value	AVG	Value	AVG	Value	AVG
						WQM was cancelled due to adverse weather															
SR5	1/3/2024	Cloudy	9:12	4.0	3.0	18.17	18.10	8.57	8.59	32.58	32.53	85.80	85.35	6.62	6.59	5.24	5.15	5.2	5.1		
			9:13	4.0	3.0	18.02		8.60	8.60	32.47	32.53	84.90	85.35	6.55	6.59	5.06	5.15	4.9	4.9		
	5/3/2024	Cloudy	8:15	3.8	2.8	20.30	20.32	8.61	8.61	32.76	32.81	93.40	92.70	6.97	6.91	4.12	4.25	2.4	2.5		
			8:16	3.8	2.8	20.34		8.61	8.61	32.85	32.81	92.00	92.00	6.85	6.85	4.38	4.25	2.6	2.6		
	7/3/2024	Cloudy	14:58	4.1	3.1	20.70	20.73	8.47	8.46	33.20	33.13	87.70	88.10	6.87	6.92	4.40	4.48	1.7	1.8		
			14:59	4.1	3.1	20.76		8.45	8.45	33.06	33.13	88.50	88.50	6.97	6.92	4.56	4.48	1.9	1.9		
	9/3/2024	Strong Mansoon	WQM was cancelled due to adverse weather																		
	11/3/2024	Cloudy	7:33	3.9	2.9	19.27	19.18	8.55	8.55	32.81	32.84	82.00	82.75	6.34	6.36	6.52	6.48	4.2	4.1		
			7:34	3.9	2.9	19.09		8.55	8.55	32.86	32.84	83.50	83.50	6.38	6.36	6.43	6.48	4.0	4.0		
	13/3/2024	Cloudy	8:21	4.0	3.0	19.50	19.51	8.44	8.44	33.16	33.14	90.60	89.85	6.83	6.77	4.75	4.55	3.2	3.4		
			8:22	4.0	3.0	19.52		8.43	8.43	33.12	33.14	89.10	89.10	6.70	6.70	4.34	4.34	3.6	3.6		
	15/3/2024	Cloudy	9:09	3.8	2.8	20.15	20.11	8.50	8.51	32.75	32.78	89.50	88.70	6.65	6.81	3.71	3.79	2.7	2.7		
			9:10	3.8	2.8	20.07		8.51	8.51	32.81	32.78	87.90	88.70	6.76	6.81	3.87	3.79	2.7	2.7		
	19/3/2024	Fine	8:42	3.9	2.9	20.69	20.75	8.53	8.53	32.16	32.09	87.30	87.15	6.60	6.59	3.71	3.83	5.3	5.1		
			8:43	3.9	2.9	20.80		8.53	8.53	32.02	32.09	87.00	87.15	6.57	6.59	3.94	3.83	4.9	4.9		
	21/3/2024	Cloudy	15:56	4.3	#VALUE!	20.63	20.67	8.60	8.61	32.00	32.21	89.10	88.55	6.72	6.69	2.93	3.01	4.0	4.2		
			15:57	4.3	#VALUE!	20.71		8.61	8.61	32.41	32.21	88.00	88.55	6.66	6.69	3.08	3.01	4.4	4.2		
	23/3/2024	Cloudy	17:27	4.2	3.2	21.94	21.84	8.62	8.62	32.60	32.55	90.30	89.90	6.86	6.83	3.21	3.43	2.1	2.0		
			17:28	4.2	3.2	21.74		8.62	8.62	32.49	32.55	89.50	89.50	6.79	6.83	3.64	3.43	1.9	1.9		
	25/3/2024	Cloudy	18:47	3.7	2.7	21.73	21.70	8.32	8.33	31.28	31.34	82.00	81.25	6.48	6.44	3.74	3.64	1.7	2.1		
			18:48	3.7	2.7	21.66		8.33	8.33	31.40	31.34	80.50	80.50	6.40	6.44	3.54	3.64	2.5	2.5		
	27/3/2024	Cloudy	7:31	4.0	3.0	23.09	23.14	8.48	8.49	30.74	30.80	88.00	87.60	6.77	6.76	4.05	4.00	2.5	2.6		
			7:32	4.0	3.0	23.18		8.49	8.49	30.86	30.80	87.20	87.60	6.74	6.76	3.95	4.00	2.7	2.7		
	29/3/2024	Cloudy	8:03	3.7	2.7	22.98	22.97	8.40	8.41	31.67	31.54	78.60	79.70	6.30	6.41	3.37	3.31	1.8	1.8		
8:04			3.7	2.7	22.96		8.42	8.42	31.41	31.54	80.80	80.80	6.51	6.41	3.25	3.31	1.7	1.7			

General Note: For calculation of average concentration of SS, the minimum value for "NOT DETECTED" is treated as 1.0mg/L according to reporting limit.



Impact Water Quality Monitoring at Station SR6 (Middle) - Ebb Tide

Station Reference	Sampling Date	Weather	Sampling Time	Water Depth m	Sampling Depth m	Temperature °C		pH		Salinity ppt		DO Saturation %		DO mg/L		Turbidity NTU		SS mg/L			
						Value	AVG	Value	AVG	Value	AVG	Value	AVG	Value	AVG	Value	AVG	Value	AVG	Value	AVG
						WQM was cancelled due to adverse weather															
SR6	1/3/2024	Cloudy	15:19	2.8	1.4	18.37															
			15:20	2.8	1.4	18.24	18.31	8.59	8.61	32.63	32.57	84.10	84.40	6.64	6.67	4.27	4.18	<1.0	<1.0	1.0	
	5/3/2024	Cloudy	18:14	2.8	1.4	20.54	20.49	8.52	8.53	32.94	32.90	89.60	90.00	6.66	6.69	2.95	2.85	2.7	2.4	2.6	
			18:15	2.8	1.4	20.43		8.53		32.85		90.40		6.72		2.75		2.4			
	7/3/2024	Cloudy	10:16	2.5	1.3	20.89	20.91	8.75	8.76	33.08	33.06	90.90	90.85	6.87	6.86	3.25	3.17	2.2	2.1	2.2	
			10:17	2.5	1.3	20.92		8.77		33.04		90.80		6.84		3.09		2.1			
	9/3/2024	Strong Mansoon	WQM was cancelled due to adverse weather																		
	11/3/2024	Cloudy	12:48	2.6	1.3	19.11	19.06	8.61	8.62	32.90	32.75	82.40	81.50	6.50	6.46	5.57	5.68	3.2	3.4	3.4	
			12:49	2.6	1.3	19.00		8.63		32.60		80.60		6.42		5.79		3.5			
	13/3/2024	Strong Mansoon	WQM was cancelled due to adverse weather																		
	15/3/2024	Cloudy	15:43	2.9	1.4	20.06	20.04	8.36	8.35	32.59	32.58	89.00	89.65	6.86	6.90	3.13	3.07	3.4	3.0	3.2	
			15:44	2.8	1.4	20.01		8.34		32.56		90.30		6.94		3.01		3.0			
	19/3/2024	Fine	18:29	2.9	1.5	20.16	20.59	8.49	8.50	32.15	32.21	88.40	88.90	6.57	6.61	4.13	4.11	2.4	2.2	2.3	
			18:30	2.9	1.5	21.01		8.51		32.26		89.40		6.64		4.09		2.2			
	21/3/2024	Cloudy	11:06	2.5	1.3	21.39	21.36	8.75	8.74	32.67	32.62	87.10	87.55	6.81	6.85	4.37	4.33	4.6	4.5	4.5	
			11:07	2.5	1.3	21.32		8.73		32.56		88.00		6.88		4.28		4.4			
	23/3/2024	Cloudy	11:52	2.5	1.3	22.36	22.38	8.63	8.63	32.01	31.95	89.50	90.10	6.69	6.75	3.25	3.13	2.2	1.4	1.8	
			11:53	2.5	1.3	22.40		8.63		31.89		90.70		6.80		3.01		1.4			
	25/3/2024	Cloudy	12:17	2.6	1.3	22.36	22.23	8.43	8.43	31.24	31.19	92.10	93.30	6.81	6.86	3.01	2.95	2.8	2.9	2.9	
			12:18	2.6	1.3	22.10		8.42		31.14		94.50		6.91		2.88		2.9			
	27/3/2024	Cloudy	13:07	2.8	1.4	23.41	23.32	8.36	8.36	31.10	30.99	88.00	88.10	6.77	6.78	3.01	3.09	2.0	2.1	2.1	
			13:08	2.8	1.4	23.23		8.35		30.88		88.20		6.78		3.16		2.2			
	29/3/2024	Cloudy	14:12	2.7	1.4	22.89	22.97	8.30	8.30	30.89	30.99	90.10	89.85	6.96	6.91	2.84	2.78	1.8	1.9	1.9	
			14:13	2.7	1.4	23.05		8.29		31.09		89.60		6.85		2.71		1.9			

General Note: For calculation of average concentration of SS, the minimum value for "NOT DETECTED" is treated as 1.0mg/L according to reporting limit.



Impact Water Quality Monitoring at Station SR6 (Middle) - Flood Tide

Station Reference	Sampling Date	Weather	Sampling Time	Water Depth m	Sampling Depth m	Temperature °C		pH		Salinity ppt		DO Saturation %		DO mg/L		Turbidity NTU		SS mg/L			
						Value	AVG	Value	AVG	Value	AVG	Value	AVG	Value	AVG	Value	AVG	Value	AVG	Value	AVG
						WQM was cancelled due to adverse weather															
SR6	1/3/2024	Cloudy	9:19	2.5	1.3	18.01	17.96	8.60	8.59	32.18	32.13	87.30	87.65	6.83	6.85	6.01	5.93	4.2	4.2		
			9:20	2.5	1.3	17.90		8.57		32.07		88.00		6.86		5.85		4.1			
	5/3/2024	Cloudy	8:22	2.3	1.2	20.42	20.40	8.62	8.64	32.65	32.57	92.70	92.10	6.93	6.88	3.87	3.81	1.9	1.8		
			8:23	2.3	1.2	20.37		8.65		32.49		91.50		6.82		3.75		1.7			
	7/3/2024	Cloudy	14:46	2.6	1.3	20.74	20.72	8.39	8.41	32.64	32.71	89.40	90.05	6.80	6.83	5.08	5.01	3.2	3.4		
			14:47	2.6	1.3	20.70		8.42		32.77		90.70		6.85		4.93		3.6			
	9/3/2024	Strong Mansoon	WQM was cancelled due to adverse weather																		
	11/3/2024	Cloudy	7:41	2.4	1.2	19.30	19.25	8.50	8.52	32.64	32.65	87.70	87.95	6.85	6.87	6.19	6.20	3.9	3.9		
			7:42	2.4	1.2	19.20		8.53		32.65		88.20		6.89		6.21		3.8			
	13/3/2024	Cloudy	8:27	2.5	1.3	19.52	19.50	8.43	8.44	33.19	33.22	88.70	89.30	6.69	6.74	4.02	3.99	2.6	2.8		
			8:28	2.5	1.3	19.48		8.45		33.25		89.90		6.78		3.95		3.0			
	15/3/2024	Cloudy	9:17	2.5	1.3	20.24	20.21	8.53	8.54	32.54	32.58	84.80	83.55	6.76	6.64	3.39	3.37	2.0	2.2		
			9:18	2.5	1.3	20.17		8.54		32.61		82.30		6.51		3.35		2.4			
	19/3/2024	Fine	8:50	2.6	1.3	20.58	20.64	8.50	8.51	31.76	31.83	87.60	86.90	6.63	6.67	3.87	3.56	3.5	3.5		
			8:51	2.6	1.3	20.69		8.52		31.89		86.20		6.70		3.25		3.4			
	21/3/2024	Cloudy	15:45	2.7	1.4	20.94	20.86	8.58	8.58	32.90	32.85	90.60	90.75	6.80	6.81	3.17	3.12	4.4	4.5		
			15:46	2.7	1.4	20.78		8.58		32.79		90.90		6.82		3.06		4.6			
	23/3/2024	Cloudy	17:15	2.7	1.4	22.01	22.09	8.64	8.64	32.09	32.04	90.30	90.20	6.81	6.81	2.84	2.73	2.0	1.6		
			17:16	2.7	1.4	22.17		8.64		31.99		90.10		6.80		2.62		1.2			
	25/3/2024	Cloudy	18:35	2.2	1.1	21.85	21.82	8.29	8.30	31.28	31.34	84.20	83.45	6.55	6.52	3.85	3.70	2.4	2.8		
			18:36	2.2	1.1	21.78		8.30		31.40		82.70		6.49		3.55		3.1			
	27/3/2024	Cloudy	7:40	2.5	1.3	23.25	23.17	8.53	8.53	30.93	30.99	84.60	84.40	6.52	6.50	2.87	2.80	2.7	2.6		
			7:41	2.5	1.3	23.09		8.52		31.04		84.20		6.48		2.72		2.4			
	29/3/2024	Cloudy	8:10	2.4	1.2	23.25	23.15	8.41	8.41	31.95	31.78	89.30	88.65	6.99	6.94	3.56	3.52	1.8	1.7		
8:11			2.4	1.2	23.04		8.40		31.61		88.00		6.89		3.47		1.6				

General Note: For calculation of average concentration of SS, the minimum value for "NOT DETECTED" is treated as 1.0mg/L according to reporting limit.



Impact Water Quality Monitoring at Station SR9 (surface) - Ebb Tide

Station Reference	Sampling Date	Weather	Sampling Time	Water Depth m	Sampling Depth m	Temperature °C		pH		Salinity ppt		DO Saturation %		DO mg/L		Turbidity NTU		SS mg/L			
						Value	AVG	Value	AVG	Value	AVG	Value	AVG	Value	AVG	Value	AVG	Value	AVG	Value	AVG
SR9	1/3/2024	Cloudy	15:03	4.4	1.0	18.76		8.67		32.68	32.74	83.60	83.20	6.65	6.63	3.86	3.98	2.5	2.7		
			15:04	4.4	1.0	18.61	18.69	8.50	8.59	32.79		82.80		6.61	6.63	4.09		2.5			
			17:59	4.2	1.0	20.35	20.31	8.54	8.54	32.34		90.80	91.65	6.82	6.89	3.41	3.35	2.3	2.2		
	5/3/2024	Cloudy	18:00	4.2	1.0	20.26		8.53		32.28	32.31	92.50		6.96	6.89	3.28		2.1			
			10:32	4.0	1.0	20.86	20.89	8.64	8.62	32.56		90.20	89.45	6.74	6.70	3.40		2.3	2.4		
	7/3/2024	Cloudy	10:33	4.0	1.0	20.91		8.60		32.60		88.70		6.66		3.37		2.5			
			WQM was cancelled due to adverse weather																		
	9/3/2024	Strong Mansoon	WQM was cancelled due to adverse weather																		
			WQM was cancelled due to adverse weather																		
	11/3/2024	Cloudy	12:32	4.2	1.0	19.18	19.20	8.61	8.61	32.80	32.87	89.00	88.95	6.90	6.90	5.76	5.86	3.3	3.6		
			12:33	4.2	1.0	19.21		8.60		32.93		88.90		6.89		5.96		3.8			
	13/3/2024	Strong Mansoon	WQM was cancelled due to adverse weather																		
			WQM was cancelled due to adverse weather																		
	15/3/2024	Cloudy	15:27	4.3	1.0	20.16	20.18	8.34	8.35	32.40	32.39	89.60	90.10	6.76	6.83	3.13	3.09	5.2	5.0		
			15:28	4.3	1.0	20.20		8.35		32.37		90.60		6.89		3.04		4.8			
	19/3/2024	Fine	18:13	4.3	1.0	20.65	20.76	8.52	8.53	32.24	32.19	91.10	90.20	6.94	6.89	4.50	4.59	3.5	3.4		
			18:14	4.3	1.0	20.87		8.54		32.14		89.30		6.89		4.68		3.2			
	21/3/2024	Cloudy	11:22	4.0	1.0	21.03	21.06	8.65	8.65	32.40	32.37	89.30	88.65	6.68	6.55	3.84	3.76	3.0	2.9		
			11:23	4.0	1.0	21.09		8.65		32.34		88.00		6.41		3.68		2.8			
	23/3/2024	Cloudy	12:07	3.9	1.0	22.17	22.12	8.52	8.52	32.34	32.32	89.60	89.15	6.84	6.82	3.44	3.34	<1.0	1.0		
			12:08	3.9	1.0	22.07		8.52		32.29		88.70		6.79		3.24		1.0			
	25/3/2024	Cloudy	12:27	4.0	1.0	22.17	22.19	8.41	8.42	30.93	30.87	83.00	83.40	6.53	6.56	3.27	3.19	3.6	3.2		
			12:28	4.0	1.0	22.21		8.42		30.80		83.80		6.59		3.11		2.8			
	27/3/2024	Cloudy	12:51	4.2	1.0	23.25	23.20	8.39	8.39	31.19	31.13	81.00	81.20	6.43	6.44	2.47	2.52	2.4	2.5		
12:52			4.2	1.0	23.15		8.38		31.07		81.40		6.44		2.56		2.6				
29/3/2024	Cloudy	13:55	4.1	1.0	22.47	22.53	8.39	8.39	31.29	31.40	91.00	90.90	6.80	6.80	2.84	2.80	2.3	2.2			
		13:56	4.1	1.0	22.58		8.38		31.51		90.80		6.79		2.76		2.1				

General Note: For calculation of average concentration of SS, the minimum value for "NOT DETECTED" is treated as 1.0mg/L according to reporting limit.



Impact Water Quality Monitoring at Station SR9 (surface) - Flood Tide

Station Reference	Sampling Date	Weather	Sampling Time	Water Depth m	Sampling Depth m	Temperature °C		pH		Salinity ppt		DO Saturation %		DO mg/L		Turbidity NTU		SS mg/L			
						Value	AVG	Value	AVG	Value	AVG	Value	AVG	Value	AVG	Value	AVG	Value	AVG	Value	AVG
SR9	1/3/2024	Cloudy	9:35	4.1	2.1	18.73	18.71	8.47	8.53	32.94	32.94	89.30	88.75	6.88	6.85	4.68	4.60	2.5	2.7		
			9:36	4.1	2.1	18.69		8.58		32.93		88.20		6.81		4.51		2.8			
			8:38	3.9	2.0	20.09	20.12	8.58	7.10	32.81	32.77	91.50	89.85	6.97	6.89	4.35	4.31	2.2	2.4		
	5/3/2024	Cloudy	8:38	3.9	2.0	20.15		8.52		32.73		88.20		6.80		4.27		2.5			
			14:30	3.8	1.9	20.64	20.72	8.56	8.55	32.98	32.93	87.60	88.25	6.64	6.67	4.97	4.89	2.9	3.1		
	7/3/2024	Cloudy	14:31	3.8	1.9	20.79		8.54		32.88		88.90		6.70		4.81		3.2			
			WQM was cancelled due to adverse weather																		
	9/3/2024	Strong Mansoon	WQM was cancelled due to adverse weather																		
			WQM was cancelled due to adverse weather																		
	11/3/2024	Cloudy	7:56	3.9	2.0	19.17	19.14	8.47	8.50	32.69	32.73	89.80	89.50	6.85	6.83	6.37	6.44	4.2	4.0		
			7:57	3.9	2.0	19.11		8.52		32.76		89.20		6.81		6.51		3.8			
	13/3/2024	Cloudy	8:43	3.9	2.0	19.69	19.69	8.46	8.46	33.14	33.15	89.40	88.40	6.98	6.85	4.37	4.25	4.0	4.1		
			8:44	3.9	2.0	19.68		8.45		33.16		87.40		6.71		4.12		4.2			
	15/3/2024	Cloudy	9:32	4.0	2.0	20.29	20.26	8.50	8.50	32.58	32.59	88.10	87.80	6.94	6.90	4.05	3.98	4.9	5.1		
			9:33	4.0	2.0	20.23		8.50		32.60		87.50		6.85		3.91		5.3			
	19/3/2024	Fine	9:04	4.0	2.0	21.09	21.04	8.54	8.54	31.86	31.81	90.60	90.05	6.88	6.86	3.56	3.58	2.6	2.6		
			9:05	4.0	2.0	20.99		8.53		31.76		89.50		6.83		3.60		2.6			
	21/3/2024	Cloudy	15:29	4.2	2.1	20.85	20.81	8.62	8.63	32.30	32.29	90.90	91.00	6.88	6.89	2.60	2.53	2.2	2.3		
			15:30	4.2	2.1	20.76		8.63		32.27		91.10		6.90		2.45		2.4			
	23/3/2024	Cloudy	16:59	4.0	2.0	21.89	21.82	8.63	8.63	32.08	32.00	90.10	90.05	6.82	6.82	2.94	2.77	2.5	2.4		
			17:00	4.0	2.0	21.74		8.62		31.92		90.00		6.82		2.60		2.2			
	25/3/2024	Cloudy	18:19	3.6	1.8	21.64	21.76	8.41	8.41	31.39	31.45	87.20	88.05	6.84	6.91	4.47	4.42	1.9	2.3		
			18:20	3.6	1.8	21.88		8.40		31.50		88.90		6.98		4.37		2.6			
	27/3/2024	Cloudy	7:56	3.9	2.0	23.06	23.12	8.47	8.48	31.08	31.12	88.20	88.10	6.84	6.84	3.47	3.38	2.7	2.5		
7:57			3.9	2.0	23.17		8.48		31.16		88.00		6.83		3.29		2.3				
29/3/2024	Cloudy	8:26	3.7	1.8	22.95	22.91	8.42	8.43	31.59	31.62	87.70	83.55	6.88	6.93	3.17	3.11	2.5	2.5			
		8:27	3.7	1.8	22.87		8.43		31.64		84.40		6.97		3.05		2.4				

General Note: For calculation of average concentration of SS, the minimum value for "NOT DETECTED" is treated as 1.0mg/L according to reporting limit.



Impact Water Quality Monitoring at Station SR9 (Bottom) - Ebb Tide

Station Reference	Sampling Date	Weather	Sampling Time	Water Depth m	Sampling Depth m	Temperature °C		pH		Salinity ppt		DO Saturation %		DO mg/L		Turbidity NTU		SS mg/L			
						Value	AVG	Value	AVG	Value	AVG	Value	AVG	Value	AVG	Value	AVG	Value	AVG	Value	AVG
						WQM was cancelled due to adverse weather															
SR9	1/3/2024	Cloudy	15:06	4.4	3.4	18.52															
			15:07	4.4	3.4	18.47	18.50	8.53	8.50	32.87	32.78	89.60	90.10	6.92	6.95	4.71	4.65	3.4	3.3		
	5/3/2024	Cloudy	18:02	4.2	3.2	20.24															
			18:03	4.2	3.2	20.37	20.31	8.52	8.52	32.22	32.26	90.60	91.00	6.97	6.83	4.58	4.65	3.1	1.7		
	7/3/2024	Cloudy	10:35	4.0	3.0	20.87															
			10:36	4.0	3.0	20.83	20.85	8.65	8.65	32.97	32.91	89.00	90.30	6.83	6.88	3.41	3.54	1.4	1.4		
	9/3/2024	Strong Mansoon	WQM was cancelled due to adverse weather																		
	11/3/2024	Cloudy	12:35	4.2	3.2	19.17															
			12:36	4.2	3.2	19.21	19.19	8.59	8.61	32.24	32.32	84.80	84.50	6.62	6.61	6.08	6.00	3.4	3.5		
	13/3/2024	Strong Mansoon	WQM was cancelled due to adverse weather																		
	15/3/2024	Cloudy	15:30	4.3	3.3	20.06															
			15:31	4.3	3.3	20.11	20.09	8.35	8.35	32.58	32.59	87.20	86.50	6.59	6.56	3.42	3.51	3.9	4.1		
	19/3/2024	Fine	18:16	4.3	3.3	20.89															
			18:17	4.3	3.3	20.68	20.79	8.52	8.52	32.04	32.10	94.60	93.60	6.87	6.82	4.17	4.10	2.7	2.6		
	21/3/2024	Cloudy	11:25	4.0	3.0	20.95															
			11:26	4.0	3.0	20.98	20.97	8.65	8.65	32.48	32.52	89.20	89.75	6.66	6.70	4.02	4.03	3.0	2.9		
	23/3/2024	Cloudy	12:09	3.9	2.9	21.86															
			12:10	3.9	2.9	21.79	21.83	8.53	8.53	32.29	32.28	89.10	89.75	6.72	6.75	2.84	2.96	1.8	1.6		
	25/3/2024	Cloudy	12:29	4.0	3.0	22.01															
			12:30	4.0	3.0	22.25	22.13	8.42	8.42	31.23	31.25	88.20	87.80	6.64	6.61	2.76	2.86	2.7	2.7		
	27/3/2024	Cloudy	12:53	4.2	3.2	23.16															
			12:54	4.2	3.2	22.89	23.03	8.38	8.38	31.45	31.38	86.50	86.15	6.60	6.57	2.94	2.82	2.2	2.1		
	29/3/2024	Cloudy	13:57	4.1	3.1	22.09															
			13:58	4.1	3.1	22.30	22.20	8.37	8.37	31.08	31.13	93.10	93.40	6.95	6.97	2.97	3.01	2.0	2.7		

General Note: For calculation of average concentration of SS, the minimum value for "NOT DETECTED" is treated as 1.0mg/L according to reporting limit.



Impact Water Quality Monitoring at Station SR9 (Bottom) - Flood Tide

Station Reference	Sampling Date	Weather	Sampling Time	Water Depth m	Sampling Depth m	Temperature °C		pH		Salinity ppt		DO Saturation %		DO mg/L		Turbidity NTU		SS mg/L			
						Value	AVG	Value	AVG	Value	AVG	Value	AVG	Value	AVG	Value	AVG	Value	AVG	Value	AVG
						WQM was cancelled due to adverse weather															
SR9	1/3/2024	Cloudy	9:38	4.1	3.1	18.91															
			9:39	4.1	3.1	18.82	18.87	8.59	8.61	32.89	32.92	86.10	86.20	6.72	6.74	4.60	4.71	3.2	3.2		
	5/3/2024	Cloudy	8:40	3.9	2.0	20.18															
			8:41	3.9	2.0	20.12	20.15	8.63	8.64	32.61	32.60	93.00	91.80	6.94	6.91	4.22	4.20	3.2	3.1		
	7/3/2024	Cloudy	14:32	3.8	2.8	20.76															
			14:33	3.8	2.8	20.80	20.78	8.56	8.56	33.06	33.04	82.90	83.50	6.53	6.57	4.28	4.35	1.7	1.8		
	9/3/2024	Strong Mansoon	WQM was cancelled due to adverse weather																		
	11/3/2024	Cloudy	7:58	3.9	2.9	19.15															
			7:59	3.9	2.9	19.20	19.18	8.50	8.48	32.59	32.63	86.00	85.20	6.69	6.65	6.24	6.22	2.6	3.1		
	13/3/2024	Cloudy	8:45	3.9	2.9	19.70															
			8:46	3.9	2.9	19.66	19.68	8.44	8.46	33.01	33.05	83.80	84.15	6.43	6.46	3.72	3.78	3.5	3.4		
	15/3/2024	Cloudy	9:35	4.0	3.0	20.18															
			9:36	4.0	3.0	20.20	20.19	8.49	8.50	32.42	32.41	83.90	84.55	6.60	6.62	4.15	4.16	3.5	3.4		
	19/3/2024	Fine	9:07	4.0	3.0	20.89															
			9:08	4.0	3.0	20.97	20.93	8.53	8.53	32.01	32.08	93.50	93.05	6.85	6.83	3.62	3.73	1.5	1.6		
	21/3/2024	Cloudy	15:32	4.2	3.2	20.74															
			15:33	4.2	3.2	20.65	20.70	8.63	8.64	32.41	32.38	90.60	90.95	6.91	6.94	3.11	3.18	3.5	3.4		
	23/3/2024	Cloudy	17:02	4.0	3.0	21.98															
			17:03	4.0	3.0	22.04	22.01	8.63	8.63	31.87	31.78	89.90	89.15	6.80	6.78	2.93	2.99	2.5	2.4		
	25/3/2024	Cloudy	18:21	3.6	2.6	21.87															
			18:22	3.6	2.6	21.67	21.77	8.41	8.41	31.44	31.46	85.90	86.10	6.73	6.76	4.17	4.27	4.0	3.6		
	27/3/2024	Cloudy	7:58	3.9	2.9	22.99															
			7:59	3.9	2.9	22.98	22.99	8.47	8.47	31.36	31.28	82.20	82.75	6.39	6.42	3.67	3.77	1.7	1.6		
	29/3/2024	Cloudy	8:28	3.7	2.7	22.86															
			8:29	3.7	2.7	22.72	22.79	8.42	8.42	31.41	31.37	82.80	81.55	6.76	6.72	3.15	3.26	1.6	1.7		

General Note: For calculation of average concentration of SS, the minimum value for "NOT DETECTED" is treated as 1.0mg/L according to reporting limit.



Impact Water Quality Monitoring at Station SR10 (Middle) - Ebb Tide

Station Reference	Sampling Date	Weather	Sampling Time	Water Depth m	Sampling Depth m	Temperature °C		pH		Salinity ppt		DO Saturation %		DO mg/L		Turbidity NTU		SS mg/L			
						Value	AVG	Value	AVG	Value	AVG	Value	AVG	Value	AVG	Value	AVG	Value	AVG	Value	AVG
						WQM was cancelled due to adverse weather															
SR10	1/3/2024	Cloudy	14:53	2.9	1.5	18.68															
			14:54	2.9	1.5	18.71	18.70	8.59	8.59	32.43	32.51	89.00	89.60	6.92	6.94	4.73	4.66	2.9	2.9		
	5/3/2024	Cloudy	17:50	2.8	1.4	20.19															
			17:51	2.8	1.4	20.18	20.19	8.56	8.55	32.67	32.61	86.10	85.45	6.63	6.58	3.23	3.32	2.4	2.3		
	7/3/2024	Cloudy	10:41	2.7	1.4	20.87															
			10:42	2.7	1.4	20.92	20.90	8.62	8.62	33.02	33.04	90.10	89.25	6.70	6.65	4.09	4.02	3.6	3.4		
	9/3/2024	Strong Mansoon	WQM was cancelled due to adverse weather																		
	11/3/2024	Cloudy	12:23	2.6	1.3	19.31															
			12:24	2.6	1.3	19.28	19.30	8.59	8.61	32.80	32.77	86.30	87.50	6.78	6.81	5.36	5.42	3.7	3.9		
	13/3/2024	Strong Mansoon	WQM was cancelled due to adverse weather																		
	15/3/2024	Cloudy	15:18	2.7	1.4	20.08															
			15:19	2.8	1.4	20.10	20.09	8.35	8.35	32.65	32.63	85.70	86.80	6.58	6.76	4.26	4.16	3.6	3.5		
	19/3/2024	Fine	18:04	2.7	1.4	20.65															
			18:05	2.7	1.4	20.78	20.72	8.54	8.54	32.11	32.08	90.70	89.65	6.85	6.82	3.84	3.91	1.8	1.7		
	21/3/2024	Cloudy	11:31	2.6	1.3	20.87															
			11:32	2.6	1.3	20.99	20.93	8.62	8.63	32.37	32.29	89.50	90.70	6.70	6.77	4.11	4.05	4.4	4.6		
	23/3/2024	Cloudy	12:16	2.5	1.3	21.98															
			12:17	2.5	1.3	21.80	21.89	8.53	8.54	31.96	31.86	87.90	88.20	6.52	6.56	4.01	3.85	2.0	1.7		
	25/3/2024	Cloudy	12:36	2.7	1.4	21.97															
			12:37	2.7	1.4	21.87	21.92	8.43	8.43	31.54	31.47	88.10	87.85	6.83	6.79	3.47	3.36	3.0	2.8		
	27/3/2024	Cloudy	12:42	2.8	1.4	23.19															
			12:43	2.8	1.4	23.12	23.16	8.38	8.38	31.09	31.01	83.70	83.30	6.65	6.68	3.27	3.15	1.4	1.5		
	29/3/2024	Cloudy	13:45	2.7	1.4	22.25															
			13:46	2.7	1.4	22.19	22.22	8.37	8.37	31.52	31.50	92.70	93.05	6.93	6.95	3.10	3.06	1.6	1.7		

General Note: For calculation of average concentration of SS, the minimum value for "NOT DETECTED" is treated as 1.0mg/L according to reporting limit.



Impact Water Quality Monitoring at Station SR10 (Middle) - Flood Tide

Station Reference	Sampling Date	Weather	Sampling Time	Water Depth m	Sampling Depth m	Temperature °C		pH		Salinity ppt		DO Saturation %		DO mg/L		Turbidity NTU		SS mg/L			
						Value	AVG	Value	AVG	Value	AVG	Value	AVG	Value	AVG	Value	AVG	Value	AVG	Value	AVG
						WQM was cancelled due to adverse weather															
SR10	1/3/2024	Cloudy	9:44	2.7	1.4	18.74															
			9:45	2.7	1.4	18.65	18.70	8.59	8.59	32.62	32.67	87.20	87.60	6.76	6.79	5.17	5.12	1.6	1.8		
	5/3/2024	Cloudy	8:47	2.4	1.2	20.19															
			8:48	2.4	1.2	20.04	20.12	8.65	8.64	32.84	32.78	87.60	87.00	6.62	6.58	3.97	3.99	1.6	1.5		
	7/3/2024	Cloudy	14:20	2.8	1.4	20.59															
			14:21	2.8	1.4	20.76	20.68	8.56	8.55	33.12	33.19	82.30	83.00	6.47	6.50	4.52	4.43	3.2	3.0		
	9/3/2024	Strong Mansoon	WQM was cancelled due to adverse weather																		
	11/3/2024	Cloudy	8:06	2.6	1.3	19.17															
			8:07	2.6	1.3	19.21	19.19	8.50	8.51	33.04	33.00	88.70	89.80	6.83	6.89	5.74	5.86	2.6	3.0		
	13/3/2024	Cloudy	8:52	2.4	1.2	19.73															
			8:53	2.4	1.2	19.70	19.72	8.48	8.46	33.16	33.14	90.00	91.05	6.89	6.94	3.56	3.53	3.6	3.6		
	15/3/2024	Cloudy	9:40	2.5	1.3	20.11															
			9:41	2.5	1.3	20.19	20.15	8.50	8.51	32.54	32.54	87.40	86.55	6.87	6.81	4.37	4.29	4.0	4.1		
	19/3/2024	Fine	9:13	2.4	1.2	20.70															
			9:14	2.4	1.2	20.78	20.74	8.52	8.52	32.06	32.10	89.00	89.65	6.73	6.75	4.47	4.43	1.7	1.8		
	21/3/2024	Cloudy	15:20	2.8	1.4	20.74															
			15:21	2.8	1.4	20.85	20.80	8.63	8.64	31.87	31.93	87.00	87.65	6.62	6.66	2.74	2.67	2.2	2.4		
	23/3/2024	Cloudy	16:49	2.6	1.3	22.10															
			16:50	2.6	1.3	21.91	22.01	8.64	8.64	31.85	31.73	86.20	86.60	6.49	6.50	3.01	2.86	<1.0	1.0		
	25/3/2024	Cloudy	18:09	2.6	1.3	22.02															
			18:10	2.6	1.3	21.89	21.96	8.40	8.40	31.74	31.68	87.70	87.95	6.82	6.84	4.69	4.63	3.5	2.9		
	27/3/2024	Cloudy	8:05	2.4	1.2	23.10															
			8:06	2.4	1.2	23.02	23.06	8.48	8.49	30.87	30.91	83.90	82.90	6.55	6.51	3.13	3.19	2.2	2.3		
	29/3/2024	Cloudy	8:36	2.3	1.2	22.58															
8:37			2.3	1.2	22.63	22.61	8.40	8.41	31.24	31.30	84.90	84.60	6.88	6.81	2.95	2.92	1.5	1.6			

General Note: For calculation of average concentration of SS, the minimum value for "NOT DETECTED" is treated as 1.0mg/L according to reporting limit.



Impact Water Quality Monitoring at Station SR12 (Middle) - Ebb Tide

Station Reference	Sampling Date	Weather	Sampling Time	Water Depth m	Sampling Depth m	Temperature °C		pH		Salinity ppt		DO Saturation %		DO mg/L		Turbidity NTU		SS mg/L			
						Value	AVG	Value	AVG	Value	AVG	Value	AVG	Value	AVG	Value	AVG	Value	AVG	Value	AVG
						WQM was cancelled due to adverse weather															
SR12	1/3/2024	Cloudy	14:47	2.7	1.4	18.68															
			14:48	2.7	1.4	18.57	18.63	8.70	8.62	32.83	32.76	84.30	84.55	6.74	6.76	5.01	5.19	3.0	2.8		
	5/3/2024	Cloudy	17:45	2.7	1.4	20.16															
			17:46	2.7	1.4	20.20	20.18	8.52	8.52	32.48	32.54	90.90	90.15	6.77	6.81	3.01	2.94	3.0	3.2		
	7/3/2024	Cloudy	10:47	2.6	1.3	20.58															
			10:48	2.6	1.3	20.64	20.61	8.50	8.55	33.11	33.13	91.60	90.15	6.83	6.78	3.67	3.76	3.2	3.1		
	9/3/2024	Strong Mansoon	WQM was cancelled due to adverse weather																		
	11/3/2024	Cloudy	12:16	2.7	1.4	19.36															
			12:17	2.7	1.4	19.40	19.38	8.61	8.61	32.76	32.65	87.70	87.55	6.85	6.84	5.27	5.23	2.6	3.1		
	13/3/2024	Strong Mansoon	WQM was cancelled due to adverse weather																		
	15/3/2024	Cloudy	15:13	2.8	1.4	20.14															
			15:14	2.8	1.4	20.09	20.12	8.37	8.37	32.71	32.70	90.80	91.80	6.87	6.93	4.12	4.16	4.0	3.9		
	19/3/2024	Fine	17:57	2.8	1.4	20.43															
			17:58	2.8	1.4	20.58	20.51	8.51	8.52	32.08	32.14	89.30	90.00	6.73	6.79	3.94	3.98	2.8	2.9		
	21/3/2024	Cloudy	11:37	2.6	1.3	20.87															
			11:38	2.6	1.3	20.65	20.76	8.65	8.65	32.18	32.24	84.30	84.55	6.80	6.52	4.02	4.07	4.2	4.1		
	23/3/2024	Cloudy	12:21	2.4	1.2	21.99															
			12:22	2.4	1.2	22.01	22.00	8.54	8.54	31.68	31.62	85.60	86.45	6.55	6.52	4.01	4.13	<1.0	1.1		
	25/3/2024	Cloudy	12:43	2.8	1.4	21.56															
			12:44	2.8	1.4	21.71	21.64	8.44	8.44	31.36	31.40	91.60	90.85	6.83	6.77	3.85	3.77	2.8	2.5		
	27/3/2024	Cloudy	12:38	2.7	1.4	23.09															
			12:39	2.7	1.4	23.17	23.13	8.39	8.39	31.06	31.05	88.10	87.90	6.86	6.85	3.47	3.52	1.8	1.7		
	29/3/2024	Cloudy	13:38	2.8	1.4	22.30															
			13:39	2.8	1.4	22.41	22.36	8.39	8.39	31.30	31.27	92.40	91.85	6.90	6.85	3.05	3.02	1.2	1.3		

General Note: For calculation of average concentration of SS, the minimum value for "NOT DETECTED" is treated as 1.0mg/L according to reporting limit.



Impact Water Quality Monitoring at Station SR12 (Middle) - Flood Tide

Station Reference	Sampling Date	Weather	Sampling Time	Water Depth m	Sampling Depth m	Temperature °C		pH		Salinity ppt		DO Saturation %		DO mg/L		Turbidity NTU		SS mg/L			
						Value	AVG	Value	AVG	Value	AVG	Value	AVG	Value	AVG	Value	AVG	Value	AVG	Value	AVG
						WQM was cancelled due to adverse weather															
SR12	1/3/2024	Cloudy	9:50	2.5	1.3	18.80															
			9:51	2.5	1.3	18.72	18.76	8.56	8.57	32.70	32.77	85.60	85.00	6.65	6.60	4.86	4.90	2.6	2.8		
	5/3/2024	Cloudy	8:53	2.3	1.2	20.09															
			8:54	2.3	1.2	20.06	20.08	8.65	8.64	32.41	32.36	88.60	89.50	6.82	6.85	3.71	3.79	1.6	1.6		
	7/3/2024	Cloudy	14:13	2.5	1.3	20.61															
			14:14	2.5	1.3	20.47	20.54	8.53	8.54	33.08	33.10	87.70	86.95	6.71	6.69	4.74	4.88	2.7	2.9		
	9/3/2024	Strong Mansoon	WQM was cancelled due to adverse weather																		
	11/3/2024	Cloudy	8:12	2.5	1.3	19.20															
			8:13	2.5	1.3	19.24	19.22	8.39	8.46	33.08	33.01	88.30	89.30	6.77	6.86	5.91	5.87	2.7	2.7		
	13/3/2024	Cloudy	8:59	2.5	1.3	19.69															
			9:00	2.5	1.3	19.72	19.71	8.46	8.46	33.20	33.19	82.20	82.90	6.45	6.48	3.41	3.33	3.0	3.2		
	15/3/2024	Cloudy	9:46	2.6	1.3	20.14															
			9:47	2.6	1.3	20.17	20.16	8.51	8.52	32.50	32.51	85.90	84.95	6.52	6.47	4.50	4.58	3.2	3.4		
	19/3/2024	Fine	9:19	2.5	1.3	20.58															
			9:20	2.5	1.3	20.69	20.64	8.52	8.53	32.10	32.12	87.70	86.60	6.85	6.78	4.36	4.31	2.3	2.3		
	21/3/2024	Cloudy	15:13	2.7	1.4	20.73															
			15:14	2.7	1.4	20.67	20.70	8.64	8.64	31.69	31.64	90.80	89.95	6.87	6.84	2.80	2.89	2.5	2.7		
	23/3/2024	Cloudy	16:40	2.6	1.3	22.06															
			16:41	2.6	1.3	22.17	22.12	8.63	8.63	31.32	31.40	86.70	86.45	6.53	6.52	3.94	4.00	3.0	2.6		
	25/3/2024	Cloudy	18:03	2.5	1.3	22.04															
			18:04	2.5	1.3	22.17	22.11	8.39	8.40	31.84	31.90	90.20	91.20	6.88	6.92	4.84	4.72	3.4	3.0		
	27/3/2024	Cloudy	8:10	2.3	1.2	23.25															
			8:11	2.3	1.2	23.36	23.31	8.48	8.48	30.76	30.80	90.20	89.70	6.88	6.85	3.08	3.17	1.7	1.7		
	29/3/2024	Cloudy	8:42	2.4	1.2	22.37															
8:43			2.4	1.2	22.41	22.39	8.42	8.42	31.17	31.19	87.50	88.25	6.90	6.91	3.25	3.20	1.4	1.3			

General Note: For calculation of average concentration of SS, the minimum value for "NOT DETECTED" is treated as 1.0mg/L according to reporting limit.



Impact Water Quality Monitoring at Station SR15 (Middle) - Ebb Tide

Station Reference	Sampling Date	Weather	Sampling Time	Water Depth m	Sampling Depth m	Temperature °C		pH		Salinity ppt		DO Saturation %		DO mg/L		Turbidity NTU		SS mg/L			
						Value	AVG	Value	AVG	Value	AVG	Value	AVG	Value	AVG	Value	AVG	Value	AVG	Value	AVG
						18.24	18.19	8.37	8.44	32.19	32.25	88.00	88.65	6.89	6.94	3.98	4.03	3.6	3.4		
15:46	2.9	1.5	18.14	18.19	8.50	8.51	32.31	32.69	89.30	90.20	6.99	6.70	4.08	4.09	3.2	3.1					
18:40	2.7	1.4	20.48	20.54	8.51	8.51	32.66	32.71	90.60	90.20	6.74	6.70	4.12	4.09	3.2	3.1					
18:41	2.7	1.4	20.60	20.60	8.50	8.50	32.71	32.71	89.80	90.20	6.65	6.70	4.06	4.09	2.9	3.1					
7/3/2024	Cloudy		9:49	2.4	1.2	21.32	21.36	8.69	8.70	32.32	32.37	89.20	88.65	6.84	6.81	4.25	4.18	3.6	3.8		
			9:50	2.4	1.2	21.40	21.40	8.71	8.71	32.41	32.41	88.10	88.65	6.78	6.81	4.10	4.18	3.9	3.8		
9/3/2024	Strong Mansoon		WQM was cancelled due to adverse weather																		
11/3/2024	Cloudy		13:16	2.6	1.3	19.10	19.07	8.45	8.51	32.94	32.88	81.60	82.15	6.38	6.41	5.08	5.19	5.0	5.5		
			13:17	2.6	1.3	19.03	19.03	8.56	8.56	32.82	32.82	82.70	82.15	6.43	6.41	5.29	5.19	6.0	5.5		
13/3/2024	Strong Mansoon		WQM was cancelled due to adverse weather																		
15/3/2024	Cloudy		16:10	2.8	1.4	20.12	20.11	8.35	8.36	32.56	32.59	87.80	86.50	6.57	6.56	3.69	3.63	3.4	3.3		
			16:11	2.8	1.4	20.10	20.11	8.36	8.36	32.61	32.61	85.20	86.50	6.54	6.56	3.57	3.63	3.1	3.3		
19/3/2024	Fine		18:54	2.3	1.2	20.89	20.95	8.51	8.51	32.67	32.56	87.60	87.05	6.64	6.63	4.01	3.96	1.3	1.3		
			19:55	2.3	1.2	21.00	21.00	8.50	8.50	32.44	32.56	86.50	87.05	6.61	6.63	3.90	3.96	1.3	1.3		
			10:39	2.4	1.2	21.08	21.10	8.67	8.68	32.15	32.18	91.00	90.85	6.88	6.87	4.37	4.25	3.6	3.5		
			10:40	2.4	1.2	21.12	21.10	8.68	8.68	32.20	32.18	90.70	90.85	6.86	6.87	4.12	4.25	3.3	3.5		
21/3/2024	Cloudy		11:24	2.4	1.2	22.77	22.79	8.55	8.54	31.59	31.64	94.90	94.40	6.92	6.89	3.84	3.77	1.3	1.3		
			11:25	2.4	1.2	22.80	22.79	8.53	8.54	31.68	31.64	93.90	94.40	6.86	6.89	3.69	3.77	1.2	1.3		
25/3/2024	Cloudy		11:49	2.7	1.4	22.06	21.98	8.42	8.43	30.79	30.91	89.80	90.30	6.70	6.74	3.70	3.58	2.9	3.1		
			11:50	2.7	1.4	21.89	21.98	8.43	8.43	31.02	30.91	90.80	90.30	6.78	6.74	3.46	3.58	3.3	3.1		
27/3/2024	Cloudy		12:36	2.7	1.4	23.17	23.09	8.39	8.39	30.91	30.85	88.70	89.15	6.69	6.73	2.99	2.95	2.3	2.2		
			12:37	2.7	1.4	23.01	23.09	8.38	8.38	30.78	30.85	89.60	89.15	6.77	6.73	2.90	2.95	2.1	2.2		
29/3/2024	Cloudy		14:42	2.7	1.4	23.17	23.09	8.26	8.27	31.95	31.91	93.00	91.80	6.84	6.86	2.67	2.62	1.2	1.2		
			14:43	2.7	1.4	23.01	23.09	8.27	8.27	31.87	31.87	90.60	91.80	6.87	6.86	2.57	2.62	1.2	1.2		

General Note: For calculation of average concentration of SS, the minimum value for "NOT DETECTED" is treated as 1.0mg/L according to reporting limit.



Impact Water Quality Monitoring at Station SR15 (Middle) - Flood Tide

Station Reference	Sampling Date	Weather	Sampling Time	Water Depth m	Sampling Depth m	Temperature °C		pH		Salinity ppt		DO Saturation %		DO mg/L		Turbidity NTU		SS mg/L			
						Value	AVG	Value	AVG	Value	AVG	Value	AVG	Value	AVG	Value	AVG	Value	AVG	Value	AVG
						18.13	18.08	8.47	8.53	32.48	32.49	85.80	85.30	6.60	6.56	5.01	4.95	3.3	3.5		
8:52	2.7	1.4	18.13	18.08	8.47	8.53	32.48	32.49	85.80	85.30	6.60	6.56	5.01	4.95	3.3	3.5					
8:53	2.7	1.4	18.03	18.03	8.58	8.62	32.50	32.40	84.80	85.30	6.51	6.49	4.89	4.95	3.7	3.5					
5/3/2024	Cloudy		7:55	2.2	1.1	20.63	20.59	8.63	8.62	32.38	32.40	90.10	90.55	6.86	6.89	4.67	4.60	1.4	1.5		
			7:56	2.2	1.1	20.55	20.59	8.61	8.61	32.41	32.40	91.00	90.55	6.92	6.89	4.53	4.60	1.5	1.5		
7/3/2024	Cloudy		15:12	2.6	1.3	20.85	20.81	8.46	8.44	32.07	32.35	90.50	90.55	6.87	6.88	4.12	4.09	2.3	2.2		
			15:13	2.6	1.3	20.77	20.81	8.43	8.44	32.62	32.35	90.60	90.55	6.88	6.88	4.05	4.09	2.1	2.2		
9/3/2024	Strong Mansoon		WQM was cancelled due to adverse weather																		
11/3/2024	Cloudy		7:14	2.4	1.2	18.88	18.93	8.57	8.56	32.72	32.68	89.50	89.25	6.83	6.82	6.17	6.25	3.1	3.9		
			7:15	2.4	1.2	18.97	18.93	8.55	8.56	32.64	32.68	89.00	89.25	6.80	6.82	6.33	6.25	4.6	3.9		
13/3/2024	Cloudy		7:59	2.5	1.3	19.71	19.70	8.38	8.39	33.10	33.07	87.80	88.55	6.62	6.66	4.27	4.24	2.7	2.6		
			8:00	2.5	1.3	19.68	19.70	8.40	8.39	33.03	33.07	89.30	88.55	6.70	6.66	4.21	4.24	2.5	2.6		
15/3/2024	Cloudy		8:49	2.4	1.2	20.23	20.22	8.50	8.51	32.64	32.61	85.90	85.50	6.66	6.63	4.17	4.11	4.8	5.0		
			8:50	2.4	1.2	20.20	20.22	8.51	8.51	32.58	32.61	85.10	85.50	6.60	6.63	4.04	4.11	5.1	5.0		
19/3/2024	Fine		8:19	2.4	1.2	20.85	20.91	8.53	8.53	31.76	31.88	88.00	88.10	6.60	6.62	4.73	4.68	2.7	2.6		
			8:20	2.4	1.2	20.96	20.91	8.53	8.53	31.99	31.88	88.20	88.10	6.63	6.62	4.62	4.68	2.5	2.6		
21/3/2024	Cloudy		16:12	2.7	1.4	20.70	20.66	8.60	8.61	32.74	32.70	89.20	88.15	6.85	6.82	3.25	3.14	2.2	2.3		
			16:13	2.7	1.4	20.61	20.66	8.61	8.61	32.65	32.70	87.10	88.15	6.79	6.82	3.03	3.14	2.4	2.3		
23/3/2024	Cloudy		17:41	2.6	1.3	22.17	22.12	8.61	8.61	32.19	32.15	90.00	90.05	6.79	6.83	2.74	2.67	2.4	2.8		
			17:42	2.6	1.3	22.07	22.12	8.61	8.61	32.10	32.15	90.10	90.05	6.86	6.83	2.60	2.67	3.1	2.8		
25/3/2024	Cloudy		19:02	2.4	1.2	21.74	21.72	8.33	8.33	31.58	31.50	87.70	88.00	6.85	6.89	4.37	4.26	2.8	2.9		
			19:03	2.4	1.2	21.69	21.72	8.32	8.33	31.42	31.50	88.30	88.00	6.93	6.89	4.15	4.26	2.9	2.9		
27/3/2024	Cloudy		7:10	2.3	1.2	23.66	23.61	8.50	8.50	30.41	30.48	90.30	90.75	6.82	6.84	3.47	3.36	2.0	2.0		
			7:11	2.3	1.2	23.56	23.61	8.50	8.50	30.54	30.48	91.20	90.75	6.86	6.84	3.25	3.36	1.9	2.0		
29/3/2024	Cloudy		7:42	2.2	1.1	23.44	23.37	8.43	8.43	31.03	31.10	84.10	85.35	6.64	6.67	4.15	4.10	1.4	1.5		
			7:43	2.2	1.1	23.29	23.37	8.42	8.43	31.17	31.10	86.60	85.35	6.69	6.67	4.04	4.10	1.6	1.5		

General Note: For calculation of average concentration of SS, the minimum value for "NOT DETECTED" is treated as 1.0mg/L according to reporting limit.



Impact Water Quality Monitoring at Station CE (surface) - Ebb Tide

Station Reference	Sampling Date	Weather	Sampling Time	Water Depth m	Sampling Depth m	Temperature °C		pH		Salinity ppt		DO Saturation %		DO mg/L		Turbidity NTU		SS mg/L				
						Value	AVG	Value	AVG	Value	AVG	Value	AVG	Value	AVG	Value	AVG	Value	AVG	Value	AVG	
CE	1/3/2024	Cloudy	14:35	8.7	4.4	16.58																
			14:36	8.7	4.4	16.48	16.54	8.63	8.63	32.13	32.07	32.13	85.30	6.72	6.70	4.19	4.25	2.8	2.9			
			17:32	8.6	4.3	20.21		8.52	8.52	32.49	32.44	32.44	91.55	6.87	6.91	3.17	3.10	2.3	2.2			
	5/3/2024	Cloudy	17:33	8.6	4.3	20.25																
			10:59	8.4	4.2	21.02	20.98	8.67	8.67	33.09	33.06	33.06	89.25	6.91	6.87	2.57	2.60	3.9	3.8			
			11:00	8.4	4.2	20.93		8.66		33.02		33.02		87.60		6.83		2.62		3.6		
	9/3/2024	Strong Monsoon	WQM was cancelled due to adverse weather																			
	11/3/2024	Cloudy	12:05	8.6	4.3	19.30	19.28	8.59	8.59	32.47	32.51	32.51	90.20	49.64	6.90	6.93	6.47	6.55	6.4	5.8		
			12:06	8.6	4.3	19.25		8.58		32.55		32.55		90.08		6.95		6.63		5.2		
	13/3/2024	Strong Monsoon	WQM was cancelled due to adverse weather																			
	15/3/2024	Cloudy	15:00	8.7	4.4	20.10	20.12	8.34	8.35	32.91	32.95	32.95	89.00	88.05	6.71	6.66	3.12	3.07	4.8	5.0		
			15:01	8.7	4.4	20.14		8.35		32.98		32.98		87.10		6.80		3.02		5.2		
	19/3/2024	Fine	17:45	8.8	4.4	20.65	20.72	8.54	8.54	32.37	32.41	32.41	91.00	90.85	6.77	6.75	2.37	2.47	1.4	1.5		
			17:46	8.8	4.4	20.78		8.53		32.45		32.45		90.60		6.73		2.56		1.6		
	21/3/2024	Cloudy	11:49	8.4	4.2	20.70	20.72	8.63	8.64	32.38	32.44	32.44	88.90	89.45	6.69	6.72	3.04	3.07	4.6	4.5		
			11:50	8.4	4.2	20.73		8.64		32.49		32.49		90.00		6.74		3.10		4.4		
	23/3/2024	Cloudy	12:34	8.4	4.2	21.87	21.84	8.55	8.55	31.87	31.91	31.91	90.10	90.35	6.69	6.70	2.71	2.69	2.0	1.9		
			12:35	8.4	4.2	21.81		8.54		31.95		31.95		90.60		6.71		2.67		1.8		
	25/3/2024	Cloudy	12:54	8.5	4.3	21.93	21.89	8.43	8.44	31.40	31.67	31.67	89.00	89.00	6.83	6.88	2.47	2.56	4.0	3.6		
			12:55	8.5	4.3	21.84		8.44		31.93		31.93		91.60		6.93		2.65		3.2		
	27/3/2024	Cloudy	12:25	8.8	4.4	22.49	22.52	8.36	8.37	31.19	31.24	31.24	89.40	90.00	6.87	6.89	2.38	2.30	2.2	2.3		
			12:26	8.8	4.4	22.55		8.37		31.28		31.28		90.60		6.91		2.21		2.4		
	29/3/2024	Cloudy	13:25	8.7	4.4	22.49	22.63	8.42	8.43	31.30	31.31	31.31	91.50	91.75	6.82	6.84	2.29	2.37	2.4	2.8		
			13:26	8.7	4.4	22.76		8.44		31.31		31.31		92.00		6.85		2.44		2.7		

General Note: For calculation of average concentration of SS, the minimum value for "NOT DETECTED" is treated as 1.0mg/L according to reporting limit.



Impact Water Quality Monitoring at Station CE (surface) - Flood Tide

Station Reference	Sampling Date	Weather	Sampling Time	Water Depth m	Sampling Depth m	Temperature °C		pH		Salinity ppt		DO Saturation %		DO mg/L		Turbidity NTU		SS mg/L				
						Value	AVG	Value	AVG	Value	AVG	Value	AVG	Value	AVG	Value	AVG	Value	AVG			
CE	1/3/2024	Cloudy	10:01	8.6	4.3	17.09	17.05	8.63	8.62	32.79	32.76	32.76	89.10	88.90	6.97	6.96	4.97	5.02	2.7	2.9		
			10:02	8.6	4.3	17.01		8.61		32.72		32.72		88.70		6.95		5.06		3.0		
	5/3/2024	Cloudy	9:05	8.2	4.1	20.41	20.36	8.62	8.62	32.81	32.78	32.78	90.90	91.15	6.90	6.93	3.62	3.75	1.6	1.7		
			9:06	8.2	4.1	20.31		8.61		32.75		32.75		91.40		6.96		3.88		1.7		
	7/3/2024	Cloudy	14:00	8.5	4.3	20.94	20.91	8.58	8.58	33.12	33.08	33.08	93.60	93.80	6.84	6.86	2.37	2.48	2.7	2.9		
			14:01	8.5	4.3	20.87		8.55		33.03		33.03		94.00		6.87		2.58		3.1		
	9/3/2024	Strong Monsoon	WQM was cancelled due to adverse weather																			
	11/3/2024	Cloudy	8:22	8.3	4.2	19.25	19.18	8.49	8.51	32.24	32.19	32.19	89.30	89.60	6.93	6.94	8.01	8.12	5.8	5.6		
			8:23	8.3	4.2	19.11		8.53		32.13		32.13		89.90		6.95		8.22		5.3		
	13/3/2024	Cloudy	9:11	8.5	4.3	19.96	19.97	8.45	8.46	32.80	32.79	32.79	90.70	89.95	6.85	6.81	3.74	3.83	6.3	6.5		
			9:12	8.5	4.3	19.98		8.46		32.78		32.78		89.20		6.77		3.91		6.6		
	15/3/2024	Cloudy	9:58	8.4	4.1	20.20	20.18	8.51	8.52	32.75	32.71	32.71	88.50	87.45	6.87	6.78	3.01	3.04	3.2	3.2		
			9:59	8.4	4.1	20.16		8.52		32.67		32.67		86.40		6.69		3.06		3.2		
	19/3/2024	Fine	9:32	8.5	4.3	20.89	20.93	8.54	8.54	32.30	32.39	32.39	88.90	88.70	6.71	6.70	2.64	2.69	1.3	1.4		
			9:33	8.5	4.3	20.97		8.54		32.47		32.47		88.50		6.68		2.73		1.5		
	21/3/2024	Cloudy	15:00	8.6	4.3	20.68	20.68	8.62	8.63	32.60	32.60	32.60	89.50	90.25	6.86	6.88	1.97	2.01	2.8	3.0		
			15:01	8.6	4.3	20.68		8.63		32.59		32.59		91.00		6.90		2.05		3.2		
	23/3/2024	Cloudy	16:28	8.5	4.3	21.84	21.81	8.62	8.63	32.09	32.11	32.11	91.20	91.45	6.95	6.93	2.31	2.24	2.4	2.0		
			16:29	8.5	4.3	21.78		8.64		32.13		32.13		91.70		6.90		2.17		1.6		
	25/3/2024	Cloudy	17:50	8.3	4.2	21.61	21.73	8.42	8.43	31.74	31.69	31.69	87.70	88.20	6.85	6.88	3.25	3.34	3.1	3.4		
			17:51	8.3	4.2	21.84		8.43		31.64		31.64		88.70		6.90		3.43		3.7		
	27/3/2024	Cloudy	8:23	8.4	4.2	23.09	23.53	8.48	8.48	31.49	31.47	31.47	88.20	88.65	6.73	6.77	2.79	2.85	1.6	1.7		
			8:24	8.4	4.2	23.97		8.47		31.44		31.44		89.10		6.80		2.90		1.8		
	29/3/2024	Cloudy	8:55	8.3	4.2	22.91	23.00	8.44	8.45	31.44	31.50	31.50	88.20	88.90	6.83	6.88	2.73	2.70	1.6	1.5		
8:56			8.3	4.2	23.09		8.45		31.56		31.56		89.60		6.92		2.67		1.4			

General Note: For calculation of average concentration of SS, the minimum value for "NOT DETECTED" is treated as 1.0mg/L according to reporting limit.



Impact Water Quality Monitoring at Station CE (Middle) - Ebb Tide

Station Reference	Sampling Date	Weather	Sampling Time	Water Depth m	Sampling Depth m	Temperature °C		pH		Salinity ppt		DO Saturation %		DO mg/L		Turbidity NTU		SS mg/L			
						Value	AVG	Value	AVG	Value	AVG	Value	AVG	Value	AVG	Value	AVG	Value	AVG	Value	AVG
						°C															
CE	1/3/2024	Cloudy	14:37	8.7	4.4	16.30															
			14:38	8.7	4.4	16.29	16.30	8.64	8.63	32.37	32.32	83.80	84.10	6.58	6.60	4.53	4.40	3.8	3.6		
	5/3/2024	Cloudy	17:34	8.6	4.3	20.24	20.22	8.50	8.51	32.27	32.33	84.40	88.50	6.62	6.80	2.89	2.99	2.6	2.7		
			17:35	8.6	4.3	20.19		8.52		32.39		88.10		6.62		3.09		2.5			
	7/3/2024	Cloudy	11:01	8.4	4.2	20.89	20.93	8.65	8.65	32.46	32.52	88.20	88.25	6.64	6.64	3.29	2.88	3.1	3.3		
			11:02	8.4	4.2	20.97		8.64		32.57		88.30		6.64		2.47		3.4			
	9/3/2024	Strong Mansoon	WQM was cancelled due to adverse weather																		
	11/3/2024	Cloudy	12:07	8.6	4.3	19.23	19.27	8.60	8.61	32.45	32.51	88.90	89.80	6.82	6.88	6.62	6.79	4.9	5.0		
			12:08	8.6	4.3	19.30		8.61		32.56		90.70		6.93		6.96		5.0			
	13/3/2024	Strong Mansoon	WQM was cancelled due to adverse weather																		
	15/3/2024	Cloudy	15:02	8.7	4.4	20.06	20.07	8.34	8.35	33.13	33.16	85.20	85.05	6.44	6.43	3.47	3.58	3.7	3.9		
			15:03	8.7	4.4	20.08		8.35		33.18		84.90		6.42		3.69		4.1			
	19/3/2024	Fine	17:47	8.8	4.4	20.77	20.71	8.53	8.53	32.42	32.49	88.40	87.80	6.67	6.64	2.25	2.19	2.6	2.5		
			17:48	8.8	4.4	20.64		8.52		32.56		87.20		6.60		2.12		2.3			
	21/3/2024	Cloudy	11:51	8.4	4.2	20.67	20.62	8.65	8.65	32.51	32.50	88.40	89.20	6.66	6.65	3.27	3.19	3.9	4.1		
			11:52	8.4	4.2	20.57		8.65		32.49		90.00		6.63		3.10		4.2			
	23/3/2024	Cloudy	12:36	8.4	4.2	21.72	21.81	8.54	8.54	32.18	32.21	89.20	90.00	6.65	6.69	2.80	2.83	2.1	2.3		
			12:37	8.4	4.2	21.90		8.54		32.24		90.80		6.73		2.85		2.4			
	25/3/2024	Cloudy	12:56	8.5	4.3	21.76	21.80	8.43	8.43	31.96	31.97	91.80	91.10	6.88	6.83	2.31	2.28	3.6	3.3		
			12:57	8.5	4.3	21.84		8.42		31.98		90.40		6.77		2.24		3.0			
	27/3/2024	Cloudy	12:27	8.8	4.4	22.76	22.64	8.37	8.37	31.67	31.70	90.80	90.10	6.95	6.92	2.09	2.11	1.9	1.9		
			12:28	8.8	4.4	22.52		8.36		31.73		89.40		6.89		2.12		1.8			
	29/3/2024	Cloudy	13:27	8.7	4.4	22.78	22.69	8.42	8.41	31.29	31.24	91.80	92.05	6.84	6.86	2.60	2.54	2.4	2.3		
			13:28	8.7	4.4	22.60		8.40		31.19		92.30		6.88		2.47		2.2			

General Note: For calculation of average concentration of SS, the minimum value for "NOT DETECTED" is treated as 1.0mg/L according to reporting limit.



Impact Water Quality Monitoring at Station CE (Middle) - Flood Tide

Station Reference	Sampling Date	Weather	Sampling Time	Water Depth m	Sampling Depth m	Temperature °C		pH		Salinity ppt		DO Saturation %		DO mg/L		Turbidity NTU		SS mg/L			
						Value	AVG	Value	AVG	Value	AVG	Value	AVG	Value	AVG	Value	AVG	Value	AVG		
						°C															
CE	1/3/2024	Cloudy	10:03	8.6	4.3	17.05	17.12	8.60	8.65	32.81	32.85	84.80	84.60	6.77	6.76	5.00	4.93	3.3	3.5		
			10:04	8.6	4.3	17.19		8.60		32.88		84.40		6.75		4.85		3.6			
	5/3/2024	Cloudy	9:07	8.2	4.1	20.15	20.20	8.60	8.62	32.32	32.37	89.60	89.45	6.85	6.85	3.25	3.21	2.6	2.5		
			9:08	8.2	4.1	20.25		8.63		32.41		89.30		6.84		3.17		2.3			
	7/3/2024	Cloudy	14:02	8.5	4.3	20.82	20.90	8.54	8.56	32.22	32.26	87.60	88.35	6.72	6.75	2.53	2.65	2.6	2.5		
			14:03	8.5	4.3	20.96		8.57		33.29		89.10		6.77		2.76		2.3			
	9/3/2024	Strong Mansoon	WQM was cancelled due to adverse weather																		
	11/3/2024	Cloudy	8:24	8.3	4.2	19.08	19.09	8.50	8.51	32.45	32.41	85.50	85.45	6.64	6.64	6.41	6.39	5.9	5.6		
			8:25	8.3	4.2	19.10		8.52		32.37		85.40		6.64		6.37		5.2			
	13/3/2024	Cloudy	9:13	8.5	4.3	19.97	19.98	8.47	8.47	32.92	32.97	88.20	89.20	6.82	6.85	3.36	3.37	5.4	5.6		
			9:14	8.5	4.3	19.99		8.46		33.02		90.20		6.88		3.38		5.8			
	15/3/2024	Cloudy	10:00	8.4	4.2	20.19	20.16	8.50	8.51	33.12	33.10	89.50	89.35	6.91	6.90	3.14	3.12	4.0	3.9		
			10:01	8.4	4.2	20.13		8.51		33.08		89.20		6.88		3.10		3.7			
	19/3/2024	Fine	9:34	8.5	4.3	20.76	20.80	8.54	8.54	32.18	32.24	84.20	83.10	6.55	6.51	2.30	2.37	1.7	1.7		
			9:35	8.5	4.3	20.83		8.54		32.29		82.00		6.47		2.44		1.7			
	21/3/2024	Cloudy	15:02	8.6	4.3	20.65	20.66	8.63	8.63	32.52	32.45	87.20	88.15	6.59	6.67	2.16	2.23	3.6	3.8		
			15:03	8.6	4.3	20.67		8.63		32.37		89.10		6.75		2.29		4.0			
	23/3/2024	Cloudy	16:30	8.5	4.3	21.74	21.82	8.63	8.63	32.44	32.41	90.40	90.50	6.65	6.86	2.51	2.49	1.8	2.0		
			16:31	8.5	4.3	21.89		8.63		32.37		90.60		6.66		2.47		2.2			
	25/3/2024	Cloudy	17:52	8.3	4.2	21.60	21.60	8.43	8.43	31.95	31.90	89.60	89.25	6.93	6.91	3.71	3.64	3.2	3.7		
			17:53	8.3	4.2	21.59		8.42		31.84		88.90		6.89		3.56		4.1			
	27/3/2024	Cloudy	8:25	8.4	4.2	22.83	22.86	8.47	8.47	31.24	31.30	88.90	88.45	6.77	6.74	2.60	2.57	2.2	2.3		
			8:26	8.4	4.2	22.89		8.47		31.36		88.00		6.70		2.55		2.4			
	29/3/2024	Cloudy	8:57	8.3	4.2	22.88	22.87	8.44	8.44	31.29	31.31	92.20	90.20	6.95	6.89	2.85	2.75	1.6	1.7		
			8:58	8.3	4.2	22.85		8.43		31.33		88.20		6.83		2.65		1.7			

General Note: For calculation of average concentration of SS, the minimum value for "NOT DETECTED" is treated as 1.0mg/L according to reporting limit.



Impact Water Quality Monitoring at Station CE (Bottom) - Ebb Tide

Station Reference	Sampling Date	Weather	Sampling Time	Water Depth m	Sampling Depth m	Temperature °C		pH		Salinity ppt		DO Saturation %		DO mg/L		Turbidity NTU		SS mg/L			
						Value	AVG	Value	AVG	Value	AVG	Value	AVG	Value	AVG	Value	AVG	Value	AVG	Value	AVG
						WQM was cancelled due to adverse weather															
CE	1/3/2024	Cloudy	14:39	8.7	7.7	16.12															
			14:40	8.7	7.7	16.07	16.10	8.60	8.62	32.56	32.51	82.90	82.75	6.51	6.51	4.40	4.50	4.0	4.2		
	5/3/2024	Cloudy	17:36	8.6	7.6	20.26															
			17:37	8.6	7.6	20.37	20.32	8.51	8.51	32.20	32.20	86.50	86.75	6.55	6.56	2.65	2.72	3.1	3.3		
	7/3/2024	Cloudy	11:03	8.4	7.4	20.84															
			11:04	8.4	7.4	20.85	20.85	8.67	8.66	32.86	32.81	84.40	83.70	6.57	6.54	4.29	4.39	3.0	2.8		
	9/3/2024	Strong Mansoon	WQM was cancelled due to adverse weather																		
	11/3/2024	Cloudy	12:09	8.6	7.6	19.20	19.20	8.61	8.62	32.92	32.88	87.70	87.45	6.85	6.85	6.92	6.82	4.3	4.7		
			12:10	8.6	7.6	19.19		8.63		32.84		87.20		6.84		6.72		5.0			
	13/3/2024	Strong Mansoon	WQM was cancelled due to adverse weather																		
	15/3/2024	Cloudy	15:04	8.7	7.7	20.05	20.03	8.33	8.33	33.81	33.50	83.90	83.55	6.36	6.34	4.09	4.04	3.0	3.2		
			15:05	8.7	7.7	20.01		8.33		33.19		83.20		6.32		3.98		3.4			
	19/3/2024	Fine	17:49	8.8	7.8	20.48	20.57	8.51	8.51	32.68	32.58	89.40	90.05	6.71	6.74	1.69	1.80	2.8	2.9		
			17:50	8.8	7.8	20.65		8.50		32.47		90.70		6.77		1.91		3.0			
	21/3/2024	Cloudy	11:53	8.4	7.4	20.74	20.69	8.66	8.67	32.70	32.69	88.20	88.65	6.66	6.68	3.29	3.35	3.6	3.4		
			11:54	8.4	7.4	20.64		8.67		32.67		89.10		6.70		3.40		3.2			
	23/3/2024	Cloudy	12:38	8.4	7.4	21.73	21.71	8.52	8.53	31.94	31.88	88.10	88.40	6.49	6.50	3.04	2.99	2.3	1.9		
			12:39	8.4	7.4	21.68		8.53		31.81		88.70		6.51		2.94		1.4			
	25/3/2024	Cloudy	12:58	8.5	7.5	21.65	21.68	8.42	8.43	31.73	31.79	90.80	91.65	6.82	6.89	1.88	2.04	3.2	3.2		
			12:59	8.5	7.5	21.70		8.43		31.84		92.50		6.96		2.19		3.2			
	27/3/2024	Cloudy	12:29	8.8	7.8	22.87	22.69	8.37	8.38	31.94	31.90	88.30	88.20	6.81	6.81	1.91	1.84	1.4	1.5		
			12:30	8.8	7.8	22.50		8.38		31.86		88.10		6.80		1.76		1.5			
	29/3/2024	Cloudy	13:29	8.7	7.7	22.72	22.81	8.43	8.43	31.40	31.39	87.70	86.90	6.70	6.65	2.68	2.78	1.8	1.9		
			13:30	8.7	7.7	22.90		8.43		31.37		86.10		6.60		2.87		1.9			

General Note: For calculation of average concentration of SS, the minimum value for "NOT DETECTED" is treated as 1.0mg/L according to reporting limit.



Impact Water Quality Monitoring at Station CE (Bottom) - Flood Tide

Station Reference	Sampling Date	Weather	Sampling Time	Water Depth m	Sampling Depth m	Temperature °C		pH		Salinity ppt		DO Saturation %		DO mg/L		Turbidity NTU		SS mg/L			
						Value	AVG	Value	AVG	Value	AVG	Value	AVG	Value	AVG	Value	AVG	Value	AVG		
						WQM was cancelled due to adverse weather															
CE	1/3/2024	Cloudy	10:05	8.6	7.6	17.06	17.08	8.62	8.66	32.83	32.89	81.90	82.10	6.33	6.37	4.27	4.33	4.0	4.0		
			10:06	8.6	7.6	17.10		8.69		32.94		82.30		6.40		4.38		4.0			
	5/3/2024	Cloudy	9:09	8.2	4.1	20.10	20.19	8.61	8.61	32.40	32.45	90.10	90.05	6.87	6.87	2.59	2.68	3.2	3.4		
			9:10	8.2	4.1	20.27		8.61		32.50		90.00		6.87		2.77		3.6			
	7/3/2024	Cloudy	14:04	8.5	7.5	20.96	20.92	8.56	8.56	33.08	33.03	89.60	90.10	6.78	6.79	2.96	2.85	1.8	1.8		
			14:05	8.5	7.5	20.85		8.56		32.97		90.60		6.80		2.74		1.7			
	9/3/2024	Strong Mansoon	WQM was cancelled due to adverse weather																		
	11/3/2024	Cloudy	8:26	8.3	7.3	19.05	19.06	8.51	8.52	32.39	32.43	82.20	81.50	6.48	6.45	6.24	6.27	4.8	4.9		
			8:27	8.3	7.3	19.07		8.52		32.46		80.80		6.41		6.30		5.0			
	13/3/2024	Cloudy	9:15	8.5	7.5	20.01	20.00	8.46	8.46	33.16	33.09	83.90	83.50	6.47	6.44	3.56	3.63	4.8	5.0		
			9:16	8.5	7.5	19.98		8.45		33.01		83.10		6.40		3.70		5.1			
	15/3/2024	Cloudy	10:02	8.4	7.4	20.08	20.07	8.50	8.50	33.05	33.03	84.30	84.55	6.47	6.49	3.97	4.02	4.2	4.3		
			10:03	8.4	7.4	20.05		8.50		33.01		84.80		6.50		4.06		4.4			
	19/3/2024	Fine	9:36	8.5	7.5	20.68	20.74	8.54	8.55	32.20	32.27	89.10	88.65	6.88	6.85	2.01	2.09	2.6	2.7		
			9:37	8.5	7.5	20.80		8.55		32.34		88.20		6.81		2.17		2.8			
	21/3/2024	Cloudy	15:04	8.6	7.6	20.62	20.63	8.62	8.63	32.62	32.73	87.70	86.90	6.65	6.62	2.59	2.48	4.5	4.3		
			15:05	8.6	7.6	20.64		8.63		32.84		86.10		6.59		2.36		4.1			
	23/3/2024	Cloudy	16:32	8.5	7.5	22.01	21.90	8.64	8.64	32.30	32.27	89.10	88.80	6.78	6.76	2.98	3.03	1.6	1.9		
			16:33	8.5	7.5	21.79		8.64		32.24		88.50		6.73		3.07		2.2			
	25/3/2024	Cloudy	17:54	8.3	7.3	21.80	21.73	8.41	8.42	31.90	31.87	89.00	90.25	6.90	6.93	3.76	3.88	2.6	3.1		
			17:55	8.3	7.3	21.66		8.42		31.84		91.50		6.95		3.99		3.6			
	27/3/2024	Cloudy	8:27	8.4	7.4	22.76	22.66	8.47	8.47	31.51	31.63	88.90	88.75	6.76	6.76	2.34	2.46	3.0	2.9		
			8:28	8.4	7.4	22.56		8.46		31.74		88.60		6.75		2.57		2.7			
	29/3/2024	Cloudy	8:59	8.3	7.3	22.74	22.77	8.42	8.41	31.41	31.36	87.70	87.40	6.79	6.77	3.05	3.00	2.2	2.2		
			9:00	8.3	7.3	22.80		8.40		31.30		87.10		6.74		2.95		2.1			

General Note: For calculation of average concentration of SS, the minimum value for "NOT DETECTED" is treated as 1.0mg/L according to reporting limit.



Impact Water Quality Monitoring at Station CF (surface) - Ebb Tide

Station Reference	Sampling Date	Weather	Sampling Time	Water Depth m	Sampling Depth m	Temperature °C		pH		Salinity ppt		DO Saturation %		DO mg/L		Turbidity NTU		SS mg/L			
						Value	AVG	Value	AVG	Value	AVG	Value	AVG	Value	AVG	Value	AVG	Value	AVG	Value	AVG
						WQM was cancelled due to adverse weather															
CF	1/3/2024	Cloudy	16:03	8.8	1.0	16.88	16.91	8.63	8.69	32.84	32.88	86.90	85.60	6.79	6.73	3.87	3.77	2.6	2.5		
			16:04	8.8	1.0	16.94	8.74	8.69	32.94	32.88	84.30	85.60	6.67	6.73	3.87	3.77	2.3	2.5			
	5/3/2024	Cloudy	18:58	8.7	1.0	20.64	20.69	8.51	8.51	32.38	32.41	84.90	87.70	6.51	6.72	2.37	2.41	1.7	1.8		
			18:59	8.7	1.0	20.74	8.50	8.50	32.44	32.44	90.50	87.70	6.93	6.72	2.45	2.41	1.9	1.8			
	7/3/2024	Cloudy	9:30	8.3	1.0	21.07	21.09	8.67	8.62	32.89	32.91	90.90	90.05	6.86	6.84	3.04	3.07	3.6	3.5		
			9:31	8.3	1.0	21.10	8.56	8.56	32.92	32.92	89.20	90.05	6.81	6.84	3.10	3.07	3.3	3.5			
	9/3/2024	Strong Mansoon	WQM was cancelled due to adverse weather																		
	11/3/2024	Cloudy	13:36	8.5	1.0	19.30	19.27	8.56	8.58	32.59	32.61	88.40	88.05	6.85	6.82	4.98	5.02	3.4	3.7		
			13:37	8.5	1.0	19.23	8.60	8.60	32.62	32.62	87.70	88.05	6.79	6.82	5.05	5.02	3.9	3.7			
	13/3/2024	Strong Mansoon	WQM was cancelled due to adverse weather																		
	15/3/2024	Cloudy	16:30	8.7	1.0	20.21	20.20	8.34	8.35	32.90	32.87	90.70	90.20	6.79	6.76	4.09	4.11	3.1	3.3		
	19/3/2024	Fine	19:20	8.9	1.0	20.78	20.74	8.54	8.55	32.28	32.24	84.90	84.50	6.66	6.64	2.19	2.24	3.3	3.2		
			19:21	8.9	1.0	20.68	8.55	8.55	32.19	32.24	84.10	84.50	6.61	6.64	2.29	2.24	3.1	3.2			
	21/3/2024	Cloudy	10:20	8.4	1.0	21.36	21.42	8.69	8.69	31.34	31.23	91.20	91.85	6.51	6.85	3.25	3.42	2.8	2.9		
			10:21	8.4	1.0	21.47	8.69	8.69	31.11	31.23	92.50	91.85	6.88	6.85	3.58	3.42	3.0	2.9			
	23/3/2024	Cloudy	11:05	8.4	1.0	22.77	22.60	8.58	8.59	31.59	31.62	92.40	91.45	6.89	6.85	2.40	2.30	1.3	1.2		
			11:06	8.4	1.0	22.42	8.60	8.60	31.64	31.62	90.50	91.45	6.81	6.85	2.19	2.30	<1.0	1.2			
	25/3/2024	Cloudy	11:30	8.6	1.0	21.94	21.90	8.38	8.39	31.48	31.50	94.50	93.30	6.97	6.89	2.96	3.00	1.2	1.6		
			11:31	8.6	1.0	21.85	8.39	8.39	31.51	31.50	92.10	93.30	6.81	6.89	3.04	3.00	1.9	1.6			
	27/3/2024	Cloudy	13:56	8.7	1.0	22.28	22.33	8.38	8.38	30.87	30.90	91.40	91.05	6.90	6.88	1.65	1.71	3.0	2.8		
			13:57	8.7	1.0	22.37	8.38	8.38	30.92	30.90	90.70	91.05	6.85	6.88	1.77	1.71	2.6	2.8			
	29/3/2024	Cloudy	15:02	8.8	1.0	22.56	22.48	8.24	8.25	31.76	31.63	91.50	89.85	6.97	6.89	1.68	1.73	1.7	1.8		
			15:03	8.8	1.0	22.40	8.25	8.25	31.49	31.63	88.20	89.85	6.80	6.89	1.77	1.73	1.9	1.8			

General Note: For calculation of average concentration of SS, the minimum value for "NOT DETECTED" is treated as 1.0mg/L according to reporting limit.



Impact Water Quality Monitoring at Station CF (surface) - Flood Tide

Station Reference	Sampling Date	Weather	Sampling Time	Water Depth m	Sampling Depth m	Temperature °C		pH		Salinity ppt		DO Saturation %		DO mg/L		Turbidity NTU		SS mg/L			
						Value	AVG	Value	AVG	Value	AVG	Value	AVG	Value	AVG	Value	AVG	Value	AVG		
						WQM was cancelled due to adverse weather															
CF	1/3/2024	Cloudy	8:33	8.4	1.0	18.15	18.12	8.71	8.66	32.76	32.82	88.00	87.85	6.89	6.89	3.47	3.55	3.3	3.4		
			8:34	8.4	1.0	18.09	8.61	8.61	32.88	32.82	87.70	87.85	6.88	6.89	3.63	3.55	3.5	3.4			
	5/3/2024	Cloudy	7:36	8.2	1.0	20.63	20.59	8.64	8.65	32.19	32.21	90.80	92.00	6.79	6.89	3.56	3.67	3.7	3.9		
			7:37	8.2	1.0	20.55	8.66	8.66	32.22	32.21	93.20	92.00	6.98	6.89	3.77	3.67	4.0	3.9			
	7/3/2024	Cloudy	15:31	8.5	1.0	20.87	20.90	8.36	8.42	32.74	32.71	89.40	89.00	6.92	6.91	3.30	3.38	3.7	3.8		
			15:32	8.5	1.0	20.93	8.48	8.48	32.68	32.71	88.60	89.00	6.89	6.91	3.46	3.38	3.9	3.8			
	9/3/2024	Strong Mansoon	WQM was cancelled due to adverse weather																		
	11/3/2024	Cloudy	6:55	8.2	1.0	19.22	19.21	8.39	8.47	32.65	32.68	88.30	87.30	6.88	6.83	5.01	5.09	3.8	3.7		
			6:56	8.2	1.0	19.19	8.54	8.54	32.70	32.68	86.30	87.30	6.78	6.83	5.17	5.09	3.5	3.7			
	13/3/2024	Cloudy	7:40	8.4	1.0	19.85	19.88	8.42	8.49	32.62	32.66	92.60	92.35	6.98	6.97	3.27	3.32	3.4	3.3		
			7:41	8.4	1.0	19.90	8.56	8.56	32.70	32.66	92.10	92.35	6.95	6.97	3.36	3.32	3.1	3.3			
	15/3/2024	Cloudy	8:30	8.2	1.0	20.30	20.30	8.51	8.51	32.81	32.86	89.30	90.20	6.75	6.84	3.56	3.50	5.2	5.0		
			8:31	8.2	1.0	20.29	8.50	8.50	32.90	32.86	91.10	90.20	6.92	6.84	3.44	3.50	4.8	5.0			
	19/3/2024	Fine	8:03	8.4	1.0	20.99	21.02	8.58	8.58	31.15	31.20	92.60	91.75	6.90	6.86	3.74	3.83	4.0	4.2		
			8:04	8.4	1.0	21.04	8.57	8.57	31.24	31.20	90.90	91.75	6.82	6.86	3.91	3.83	4.3	4.2			
	21/3/2024	Cloudy	16:32	8.6	1.0	21.31	21.26	8.74	8.74	31.87	31.91	91.50	91.00	6.87	6.84	2.09	2.14	4.4	4.6		
			16:33	8.6	1.0	21.20	8.74	8.74	31.95	31.91	90.50	91.00	6.81	6.84	2.18	2.14	4.5	4.6			
	23/3/2024	Cloudy	17:59	8.6	1.0	22.04	22.02	8.67	8.67	32.12	32.06	90.90	91.85	6.80	6.85	1.40	1.48	1.8	1.6		
			18:00	8.6	1.0	21.99	8.67	8.67	31.99	32.06	92.80	91.85	6.89	6.85	1.56	1.48	1.4	1.6			
	25/3/2024	Cloudy	19:20	8.3	1.0	21.51	21.62	8.32	8.32	31.68	31.71	88.20	88.45	6.89	6.90	2.65	2.74	1.9	2.0		
			19:21	8.3	1.0	21.73	8.32	8.32	31.74	31.71	88.70	88.45	6.90	6.90	2.83	2.74	2.1	2.0			
	27/3/2024	Cloudy	6:51	8.2	1.0	23.45	23.41	8.48	8.48	30.89	30.84	82.60	82.80	6.50	6.52	1.98	2.04	3.1	3.0		
			6:52	8.2	1.0	23.36	8.48	8.48	30.78	30.84	83.00	82.80	6.53	6.52	2.09	2.04	2.9	3.0			
	29/3/2024	Cloudy	7:23	8.2	1.0	23.01	23.00	8.45	8.46	31.59	31.62	87.70	88.75	6.94	6.96	2.05	2.13	1.3	1.2		
7:24			8.2	1.0	23.16	8.46	8.46	31.64	31.62	89.80	88.75	6.97	6.96	2.21	2.13	1.1	1.2				

General Note: For calculation of average concentration of SS, the minimum value for "NOT DETECTED" is treated as 1.0mg/L according to reporting limit.



Impact Water Quality Monitoring at Station CF (Middle) - Ebb Tide

Station Reference	Sampling Date	Weather	Sampling Time	Water Depth m	Sampling Depth m	Temperature °C		pH		Salinity ppt		DO Saturation %		DO mg/L		Turbidity NTU		SS mg/L			
						Value	AVG	Value	AVG	Value	AVG	Value	AVG	Value	AVG	Value	AVG	Value	AVG	Value	AVG
						CF	1/3/2024	Cloudy	16:05	8.8	4.4	17.16	17.16	8.60	8.61	32.62	32.56	82.00	82.80	6.59	6.61
			16:06	8.9	4.4	17.15		8.62		32.50		83.60		6.63		3.79		1.7			
	5/3/2024	Cloudy	19:00	8.7	4.4	20.49	20.44	8.52	8.52	32.30	32.37	87.90	87.55	6.56	6.69	2.69	2.61	2.4	2.3		
			19:01	8.7	4.4	20.38		8.52		32.44		87.30		6.61		2.52		2.2			
	7/3/2024	Cloudy	9:32	8.3	4.2	21.01	21.00	8.67	8.68	32.80	32.82	91.50	89.25	6.91	6.77	2.37	2.47	4.3	4.2		
			9:33	8.3	4.2	20.99		8.68		32.83		87.00		6.63		2.57		4.0			
	9/3/2024	Strong Monsoon	WQM was cancelled due to adverse weather																		
	11/3/2024	Cloudy	13:38	8.5	4.3	19.34	19.38	8.58	8.54	32.33	32.31	82.40	81.50	6.54	6.48	5.19	5.14	4.7	5.4		
			13:39	8.5	4.3	19.42		8.49		32.29		80.60		6.42		5.09		6.0			
	13/3/2024	Strong Monsoon	WQM was cancelled due to adverse weather																		
	15/3/2024	Cloudy	16:32	8.7	4.4	20.15	20.17	8.34	8.34	32.56	32.52	87.20	87.60	6.64	6.68	4.04	4.01	4.1	3.9		
			16:33	8.7	4.4	20.18		8.34		32.47		88.00		6.72		3.98		3.7			
	19/3/2024	Fine	19:22	8.9	4.5	20.47	20.51	8.54	8.54	32.15	32.17	88.40	88.05	6.83	6.81	2.52	2.45	2.7	2.6		
			19:23	8.9	4.5	20.54		8.54		32.18		87.70		6.79		2.37		2.5			
			19:22	8.4	4.2	21.27	21.28	8.70	8.70	32.06	32.04	90.20	90.70	6.78	6.84	3.40	3.30	3.2	3.4		
	21/3/2024	Cloudy	10:23	8.4	4.2	21.29	21.28	8.69	8.70	32.01	32.04	91.20	90.70	6.89	6.84	3.19	3.30	3.5	3.4		
			11:07	8.4	4.2	22.17	22.10	8.58	8.58	32.06	32.13	91.30	90.90	6.84	6.81	2.37	2.44	1.2	1.3		
			11:08	8.4	4.2	22.02		8.58		32.19		90.50		6.78		2.50		1.4			
	25/3/2024	Cloudy	11:32	8.6	4.3	21.77	21.67	8.40	8.40	31.44	31.40	91.00	91.15	6.84	6.85	2.85	2.90	1.8	1.5		
			11:33	8.6	4.3	21.57		8.40		31.36		91.30		6.85		2.95		1.2			
	27/3/2024	Cloudy	13:58	8.7	4.4	22.59	22.67	8.38	8.39	30.90	30.83	89.40	88.75	6.81	6.79	1.94	1.98	2.4	2.3		
			13:59	8.7	4.4	22.74		8.39		30.76		88.10		6.77		2.01		2.2			
	29/3/2024	Cloudy	15:04	8.8	4.4	22.59	22.60	8.24	8.24	31.19	31.24	88.60	87.75	6.82	6.76	1.96	1.85	1.5	1.6		
			15:05	8.8	4.4	22.61		8.24		31.28		86.90		6.70		1.74		1.7			

General Note: For calculation of average concentration of SS, the minimum value for "NOT DETECTED" is treated as 1.0mg/L according to reporting limit.



Impact Water Quality Monitoring at Station CF (Middle) - Flood Tide

Station Reference	Sampling Date	Weather	Sampling Time	Water Depth m	Sampling Depth m	Temperature °C		pH		Salinity ppt		DO Saturation %		DO mg/L		Turbidity NTU		SS mg/L			
						Value	AVG	Value	AVG	Value	AVG	Value	AVG	Value	AVG	Value	AVG	Value	AVG	Value	AVG
						CF	1/3/2024	Cloudy	8:35	8.4	4.2	18.16	18.18	8.60	8.62	32.98	32.99	87.40	86.75	6.85	6.81
			8:36	8.4	4.2	18.20		8.64		32.99		86.10		6.76		3.52		3.0			
	5/3/2024	Cloudy	7:38	8.2	4.1	20.35	20.36	8.65	8.61	32.39	32.41	89.40	90.50	6.72	6.80	3.99	3.83	3.4	3.3		
			7:39	8.2	4.1	20.37		8.57		32.43		91.60		6.88		3.67		3.1			
	7/3/2024	Cloudy	15:33	8.5	4.3	20.91	20.89	8.49	8.54	32.69	32.72	84.10	83.05	6.59	6.46	3.59	3.51	3.4	3.3		
			15:34	8.5	4.3	20.87		8.59		32.74		82.00		6.42		3.42		3.1			
	9/3/2024	Strong Monsoon	WQM was cancelled due to adverse weather																		
	11/3/2024	Cloudy	6:57	8.2	4.1	19.12	19.11	8.50	8.51	32.50	32.54	83.20	82.60	6.59	6.54	5.82	5.89	5.4	5.3		
			6:58	8.2	4.1	19.09		8.52		32.58		82.00		6.48		5.95		5.1			
	13/3/2024	Cloudy	7:44	8.4	4.2	19.67	19.66	8.40	8.41	32.98	32.95	90.10	89.25	6.90	6.81	3.35	3.27	3.6	3.8		
			7:45	8.4	4.2	19.64		8.41		32.92		88.40		6.71		3.18		3.9			
	15/3/2024	Cloudy	8:32	8.2	4.1	20.21	20.21	8.49	8.50	32.74	32.78	89.00	90.00	6.71	6.80	3.37	3.32	4.4	4.3		
			8:33	8.2	4.1	20.20		8.50		32.82		91.00		6.88		3.26		4.1			
	19/3/2024	Fine	8:05	8.4	4.2	20.87	20.85	8.56	8.57	31.60	31.59	88.30	89.75	6.64	6.77	3.41	3.50	3.5	3.4		
			8:06	8.4	4.2	20.82		8.57		31.57		91.20		6.90		3.41		3.2			
	21/3/2024	Cloudy	16:34	8.6	4.3	21.19	21.20	8.73	8.74	32.21	32.31	87.60	87.30	6.75	6.74	2.35	2.26	4.4	4.5		
			16:35	8.6	4.3	21.20		8.74		32.41		87.00		6.72		2.17		4.6			
	23/3/2024	Cloudy	18:01	8.6	4.3	21.86	21.81	8.66	8.67	32.06	32.12	89.70	90.80	6.78	6.81	1.50	1.60	1.9	2.1		
			18:02	8.6	4.3	21.76		8.67		32.17		91.90		6.83		1.69		2.2			
	25/3/2024	Cloudy	19:22	8.3	4.2	21.60	21.57	8.33	8.33	31.90	31.89	85.90	85.35	6.83	6.80	2.79	2.75	1.3	1.5		
			19:23	8.3	4.2	21.53		8.32		31.87		84.80		6.76		2.70		1.6			
	27/3/2024	Cloudy	6:53	8.2	4.1	23.18	23.10	8.49	8.49	31.10	31.05	84.40	84.70	6.67	6.69	2.16	2.14	2.8	2.7		
			6:54	8.2	4.1	23.02		8.48		31.00		85.00		6.70		2.11		2.5			
	29/3/2024	Cloudy	7:25	8.2	4.1	22.87	22.91	8.44	8.44	31.47	31.39	87.30	86.95	6.83	6.80	2.27	2.32	<1.0	1.0		
			7:26	8.2	4.1	22.95		8.44		31.30		86.60		6.77		2.36		<1.0			

General Note: For calculation of average concentration of SS, the minimum value for "NOT DETECTED" is treated as 1.0mg/L according to reporting limit.



Impact Water Quality Monitoring at Station CF (Bottom) - Ebb Tide

Station Reference	Sampling Date	Weather	Sampling Time	Water Depth m	Sampling Depth m	Temperature °C		pH		Salinity ppt		DO Saturation %		DO mg/L		Turbidity NTU		SS mg/L			
						Value	AVG	Value	AVG	Value	AVG	Value	AVG	Value	AVG	Value	AVG	Value	AVG	Value	AVG
						WQM was cancelled due to adverse weather															
CF	1/3/2024	Cloudy	16:07	8.8	7.8	17.32	17.31	8.57	8.59	32.09	32.12	80.80	79.70	6.32	3.30	3.25	1.2	1.3			
			16:08	8.9	7.8	17.29	17.31	8.60	8.59	32.14	32.12	78.60	79.70	6.25	3.19	3.25	1.3	1.3			
	5/3/2024	Cloudy	19:02	8.7	7.7	20.50	20.47	8.53	8.53	32.29	32.29	88.70	90.40	6.90	2.60	2.66	2.8	2.7			
			19:03	8.7	7.7	20.44	20.47	8.52	8.53	32.28	32.29	92.10	90.40	6.86	2.72	2.66	2.6	2.7			
	7/3/2024	Cloudy	9:34	8.3	7.3	20.96	20.95	8.68	8.68	33.12	33.16	89.40	90.20	6.87	2.61	2.55	4.7	4.9			
			9:35	8.3	7.3	20.94	20.95	8.68	8.68	33.19	33.16	91.00	90.20	6.92	2.49	2.55	5.1	5.1			
	9/3/2024	Strong Mansoon	WQM was cancelled due to adverse weather																		
	11/3/2024	Cloudy	13:40	8.5	7.5	19.27	19.29	8.37	8.47	32.09	32.13	86.00	86.00	6.66	5.21	5.29	5.5	6.1			
			13:41	8.5	7.5	19.31	19.29	8.56	8.47	32.16	32.13	86.20	86.00	6.69	5.36	5.29	6.6	6.6			
	13/3/2024	Strong Mansoon	WQM was cancelled due to adverse weather																		
	15/3/2024	Cloudy	16:34	8.7	7.7	20.08	20.05	8.30	8.31	32.32	32.36	88.10	88.70	6.74	3.65	3.79	4.8	4.7			
			16:35	8.7	7.7	20.01	20.05	8.31	8.31	32.40	32.36	89.30	88.70	6.82	3.92	3.79	4.6	4.6			
	19/3/2024	Fine	19:24	8.9	7.9	20.29	20.33	8.54	8.55	32.03	32.02	92.10	91.95	6.91	6.90	2.87	2.3	2.2			
			19:25	8.9	7.9	20.37	20.33	8.55	8.55	32.01	32.02	91.80	91.95	6.90	2.90	2.87	2.0	2.0			
	21/3/2024	Cloudy	10:24	8.4	7.4	21.12	21.16	8.71	8.71	32.00	32.05	86.60	86.00	6.44	2.89	2.99	4.0	3.9			
			10:25	8.4	7.4	21.19	21.16	8.71	8.71	32.09	32.05	86.40	86.00	6.51	3.08	2.99	3.7	3.9			
	23/3/2024	Cloudy	11:09	8.4	7.4	21.89	21.94	8.59	8.59	31.87	31.91	90.90	90.95	6.78	4.30	4.07	1.4	1.8			
			11:10	8.4	7.4	21.98	21.94	8.58	8.59	31.94	31.91	91.00	90.95	6.81	3.84	4.07	2.2	1.8			
	25/3/2024	Cloudy	11:34	8.6	7.6	21.68	21.59	8.40	8.41	31.19	31.21	93.80	93.55	6.90	2.66	2.55	1.8	1.6			
			11:35	8.6	7.6	21.49	21.59	8.41	8.41	31.22	31.21	93.30	93.55	6.88	2.43	2.55	1.4	1.6			
	27/3/2024	Cloudy	14:00	8.7	7.7	22.69	22.78	8.39	8.39	31.35	31.30	88.50	89.25	6.78	2.25	2.17	1.6	1.7			
			14:01	8.7	7.7	22.87	22.78	8.39	8.39	31.24	31.30	90.00	89.25	6.83	2.08	2.17	1.8	1.7			
	29/3/2024	Cloudy	15:06	8.8	7.8	22.47	22.60	8.25	8.25	31.25	31.35	89.60	90.00	6.85	2.25	2.31	1.2	1.3			
			15:07	8.8	7.8	22.72	22.60	8.25	8.25	31.45	31.35	90.40	90.00	6.87	2.36	2.31	1.3	1.3			

General Note: For calculation of average concentration of SS, the minimum value for 'NOT DETECTED' is treated as 1.0mg/L according to reporting limit.



Impact Water Quality Monitoring at Station CF (Bottom) - Flood Tide

Station Reference	Sampling Date	Weather	Sampling Time	Water Depth m	Sampling Depth m	Temperature °C		pH		Salinity ppt		DO Saturation %		DO mg/L		Turbidity NTU		SS mg/L			
						Value	AVG	Value	AVG	Value	AVG	Value	AVG	Value	AVG	Value	AVG	Value	AVG	Value	AVG
						WQM was cancelled due to adverse weather															
CF	1/3/2024	Cloudy	8:37	8.4	7.4	18.30	18.25	8.58	8.59	32.58	32.54	84.80	85.00	6.55	4.21	4.19	2.5	2.6			
			8:38	8.4	7.4	18.20	18.25	8.60	8.59	32.49	32.54	85.20	85.00	6.59	4.17	4.19	2.7	2.6			
	5/3/2024	Cloudy	7:40	8.2	7.2	20.27	20.30	8.59	8.61	32.74	32.80	87.70	87.40	6.70	3.92	3.98	2.5	2.7			
			7:41	8.2	7.2	20.32	20.30	8.63	8.61	32.85	32.80	87.10	87.40	6.66	4.03	3.98	2.8	2.7			
	7/3/2024	Cloudy	15:35	8.5	7.5	20.92	20.91	8.60	8.54	33.14	33.10	91.20	90.60	6.91	2.67	2.79	2.6	2.5			
			15:36	8.5	7.5	20.90	20.91	8.47	8.54	33.05	33.10	90.00	90.60	6.87	2.90	2.79	2.3	2.5			
	9/3/2024	Strong Mansoon	WQM was cancelled due to adverse weather																		
	11/3/2024	Cloudy	6:59	8.2	7.2	19.10	19.09	8.50	8.49	32.86	32.92	82.00	81.25	6.46	6.43	6.11	6.06	5.0	5.3		
			7:00	8.2	7.2	19.08	19.09	8.48	8.49	32.97	32.92	80.50	81.25	6.40	6.01	6.06	5.6	5.3			
	13/3/2024	Cloudy	7:47	8.4	7.4	19.56	19.53	8.40	8.39	33.09	33.05	91.10	91.20	6.85	3.21	3.15	4.1	4.2			
			7:48	8.4	7.4	19.50	19.53	8.38	8.39	33.01	33.05	91.30	91.20	6.98	3.09	3.15	4.3	4.2			
	15/3/2024	Cloudy	8:34	8.2	7.2	20.17	20.18	8.50	8.50	32.55	32.61	84.30	84.05	6.50	3.09	3.09	3.8	3.7			
			8:35	8.2	7.2	20.18	20.18	8.50	8.50	32.67	32.61	83.80	84.05	6.45	3.08	3.09	3.5	3.7			
	19/3/2024	Fine	8:07	8.4	7.4	20.77	20.71	8.57	8.57	32.39	32.33	90.40	90.75	6.86	3.36	3.43	2.3	2.4			
			8:08	8.4	7.4	20.64	20.71	8.57	8.57	32.27	32.33	91.10	90.75	6.87	3.50	3.43	2.5	2.4			
	21/3/2024	Cloudy	16:36	8.6	7.6	21.23	21.20	8.73	8.73	31.86	31.89	89.10	89.65	6.76	2.37	2.48	4.0	4.1			
			16:37	8.6	7.6	21.16	21.20	8.72	8.73	31.91	31.89	90.20	89.65	6.80	2.59	2.48	4.2	4.1			
	23/3/2024	Cloudy	18:03	8.6	7.6	21.80	21.75	8.67	8.68	32.23	32.35	88.40	88.15	6.50	2.82	2.75	2.1	1.8			
			18:04	8.6	7.6	21.69	21.75	8.68	8.68	32.46	32.35	87.90	88.15	6.46	2.67	2.75	1.4	1.8			
	25/3/2024	Cloudy	19:24	8.3	7.3	21.67	21.62	8.31	8.31	32.04	31.98	89.00	88.35	6.92	2.28	2.35	1.6	1.5			
			19:25	8.3	7.3	21.56	21.62	8.31	8.31	31.92	31.98	87.70	88.35	6.85	2.41	2.35	1.4	1.5			
	27/3/2024	Cloudy	6:55	8.2	7.2	22.91	22.88	8.49	8.49	30.83	30.89	80.70	81.75	6.25	6.31	2.56	2.60	2.2	2.3		
			6:56	8.2	7.2	22.84	22.88	8.49	8.49	30.95	30.89	82.80	81.75	6.36	2.63	2.60	2.3	2.3			
	29/3/2024	Cloudy	7:27	8.2	7.2	22.90	22.85	8.44	8.44	31.41	31.53	87.70	87.30	6.84	2.69	2.83	<1.0	1.0			
7:28			8.2	7.2	22.79	22.85	8.44	8.44	31.65	31.53	86.00	87.30	6.78	2.96	2.83	<1.0	1.0				

General Note: For calculation of average concentration of SS, the minimum value for 'NOT DETECTED' is treated as 1.0mg/L according to reporting limit.



Appendix 4.5

Monthly Summary Waste Flow Table

Drainage Services Department
Contract No. DC/2020/02
Construction of San Shek Wan Sewage Treatment Works,
Associated Submarine Outfall and Pui O Sewerage Works

Monthly Summary Waste Flow Table for 2024

Month	Actual Quantities of Inert C&D Material Generated Monthly						Actual Quantities of C&D Wastes Generated Monthly				
	Total Quantity Generated (a) (in '000m ³)	Hard Rocks and Large Broken Concrete (b) (in '000m ³)	Reused in the Contract (c) (in '000m ³)	Reused in other Projects (d) (in '000m ³)	Disposed as Public Fill (a-b-c-d) (in '000m ³)	Imported Fill (in '000m ³)	Metals (in '000kg)	Paper/card-board packaging (in '000kg)	Plastics [see Note 3] (in '000kg)	Chemical waste (in '000kg)	Others. e.g. general refuse (in '000kg)
Jan	1.68	0.00	0.00	0.00	1.68	0.00	0.00	0.00	0.00	0.00	8.63
Feb	0.18	0.00	0.00	0.00	0.18	0.00	8.16	0.04	0.00	0.00	17.86
Mar	0.19	0.00	0.00	0.00	0.19	0.00	0.01	0.05	0.00	0.00	13.31
Apr											
May											
Jun											
Sub-total	2.05	0.00	0.00	0.00	2.05	0.00	8.16	0.09	0.00	0.00	39.80
July											
Aug											
Sept											
Oct											
Nov											
Dec											
Total	2.05	0.00	0.00	0.00	2.05	0.00	8.16	0.09	0.00	0.00	39.80

- Notes:
- (1) The inert C&D material except slurry and bentonite are disposed at Mui Wo Temporary Public Fill Bank (MW-PFRF) or Tuen Mun Area 38 Fill Bank (TM38-FB)
 - (2) The slurry and bentonite are disposed at Tseung Kwan O Area 137 Fill Bank (TKO137FB)
 - (3) The non-inert waste is disposed at NENT or Outlying Islands Transfer Facilities
 - (4) The waste flow table shall also include C&D materials that are specified in the Contract to be imported for use at the Site.
 - (5) Plastics refer to plastic bottles/containers, plastic sheets/foam from packaging material
 - (6) Assume the density of fill material is 2 tonne/m³.



Appendix 6.1

Three Months Rolling Programme

KL-CW JV

Tentative Three Months Construction Rolling Program Contract No.: DC/2020/02 Construction of San Shek Wan Sewage Treatment Works, Associated Submarine Outfall and Pui O Sewerage Works	Reference No. : DC/2020/02 Revision No. : -
--	--

Construction Activities for the reporting period

Item	Construction Activities
1	Excavation, sewer laying, construction of manhole at Pui O Lo Uk Tsuen, South Lantau Road, Pui O Beach
2	Excavation and site formation at SSWSTW and POSPS
3	Removal works of ELS
4	ELS works
5	Superstructure RC Works

KL-CW JV

Tentative Three Months Construction Rolling Program Contract No.: DC/2020/02 Construction of San Shek Wan Sewage Treatment Works, Associated Submarine Outfall and Pui O Sewerage Works	Reference No. : DC/2020/02 Revision No. : -
--	--

Tentative Three Months (April, May and June 2024) Construction Rolling Program

Item	Construction Activities
1	Excavation, sewer laying, construction of manhole at Pui O Lo Uk Tsuen, South Lantau Road, Pui O Beach
2	Dredging at marine
3	Site formation works
4	Drilling works
5	Excavation works
6	ELS works
7	Superstructure RC Works
8	Removal works of ELS