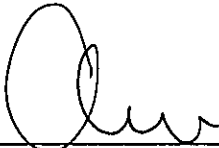

MTR Corporation Limited

Kwun Tong Line Extension (KTE)

Monthly EM&A Report (August 2014)

Verified by:  _____

Position: Independent Environmental Checker

Date: 15 Sept 2014

MTR Corporation Limited

Kwun Tong Line Extension (KTE)

Monthly EM&A Report (August 2014)

Certified by:  _____

Position: Environmental Team Leader

Date: 15 SEP 2014

EXECUTIVE SUMMARY

The Kwun Tong Line Extension (KTE) Project was awarded to the respective contractors in late May 2011. The EM&A programme for the Kwun Tong Line Extension (KTE) Project commenced on 20 June 2011, the commencement date of construction of the Project. This is the 38th monthly Environmental Monitoring and Audit (EM&A) Report for Kwun Tong Line Extension (KTE) Project. The Report presents the results of EM&A works and the impact monitoring for the construction works undertaken during the period of 1 August 2014 to 31 August 2014. The major construction activities in the reporting period included temporary road & traffic diversion, bulk excavation, adit and tunnel excavation, soil nailing, ground improvement works and tunnel lining.

No exceedance was recorded for TSP and construction noise monitoring in this reporting month.

No valid environmental complaint was received in this reporting month.

Regular joint site inspections, led by the ER with the presence of representatives from the Contractors and Environmental Team, were conducted on a weekly basis to monitor Contractors' performance on environmental management and implementation of environmental pollution control and mitigation measures for the Project.

A non-compliance in related to site water management was identified in this reporting period. Details of the event and follow up actions proposed by Contractor are provided in Section 8 of the report.

Future key issues envisaged in the coming month include noise and dust emission, and site water control issues at work sites. ET will continue the implementation of EM&A programme in accordance to the EM&A manual. Details of future key issues produced by construction activities are given in Section 12 of the report.

The Environmental Permit (EP-399/2010/B) dated on 7 June 2012 is being used for the KTE Project.

EXECUTIVE SUMMARY

1 INTRODUCTION

- 1.1 Project Background**
- 1.2 Project Programme**
- 1.3 Coverage of the EM&A Report**

2 PROJECT INFORMATION

- 2.1 Project Management Organization and Contact Details**
- 2.2 Project Works Areas and Environmental Monitoring Locations**
- 2.3 Summary of EM&A Requirements**
- 2.4 Implementation of Environmental Mitigation Measures**
- 2.5 Construction Activities in the Reporting Month**
- 2.6 Construction Activities for the Coming Month**

3 IMPACT MONITORING

- 3.1 Air Quality**
- 3.2 Noise**
- 3.3 Action taken in Event of Exceedance**

4 LANDSCAPE AND VISUAL

- 4.1 Monitoring Requirements**
- 4.2 Audit Results**
- 4.3 Action Taken in Event of Non-Conformance**

5 WASTE MANAGEMENT

6 WATER QUALITY

7 RECORD OF ENVIRONMENTAL COMPLAINTS

8 RECORD OF NON- COMPLIANCES

9 NOTIFICATION OF SUMMONS AND PROSECUTIONS

10 STATUS OF STATUTORY SUBMISSIONS

- 10.1 Submissions required under Environmental Permits**
- 10.2 Statutory Permits and Licenses**

11 SITE INSPECTIONS

- 11.1 Observations**
- 11.2 Other Notable Events**

12 FUTURE KEY ISSUES

- 12.1 Key Issues for the Coming Month**
- 12.2 Effectiveness and Efficiency of Mitigation Measures**

13 CONCLUSIONS

List of Appendices

Appendix A	Figures
Appendix B	Environmental Quality Performance Limits
Appendix C	Event Action Plans
Appendix D	Implementation of Environmental Mitigation Measures
Appendix E	Calibration Details
Appendix F	Impact Monitoring Graphical Plots
Appendix G	Monitoring Schedule for the Present and Next Reporting Period

1 INTRODUCTION

1.1 Project Background

MTR Corporation Limited (MTRCL) proposes to build a new railway line, the Kwun Tong Line Extension (KTE), otherwise referred to as ‘the Project’, which is an extension of the existing Kwun Tong Line from Yau Ma Tei Station to Whampoa area. The route length of the fully underground KTE is approximately 2.6 km with two new stations namely Ho Man Tin Station (HOM) and Whampoa Station (WHA), and a new ancillary ventilation building at Wylie Road.

1.2 Project Programme

The Kwun Tong Line Extension (KTE) Project was awarded to the respective Contractors Nishimatsu Construction Co. Ltd (NCC) and Chun Wo-Hip Hing Joint Venture (CHJV) for construction in late May 2011. The commencement of construction was on 20 June 2011. The commencement of operation of the Project is scheduled to be in 2015. Contractors’ summary programme for Contract 1001 and Contract 1002 are presented below.

NCC, as the Contractor of Contract 1001, is responsible for the construction of alignment link from the existing Yau Ma Tei Station to Wuhu Street at Whampoa and the new Ho Man Tin Station as well as the ancillary ventilation building at Wylie Road. CHJV, as the Contractor of Contract 1002, is responsible for the construction of the underground Whampoa Station and a platform & overrun tunnel.

Contract 1001 – Yau Ma Tei to Whampoa Tunnels and Ho Man Tin Station

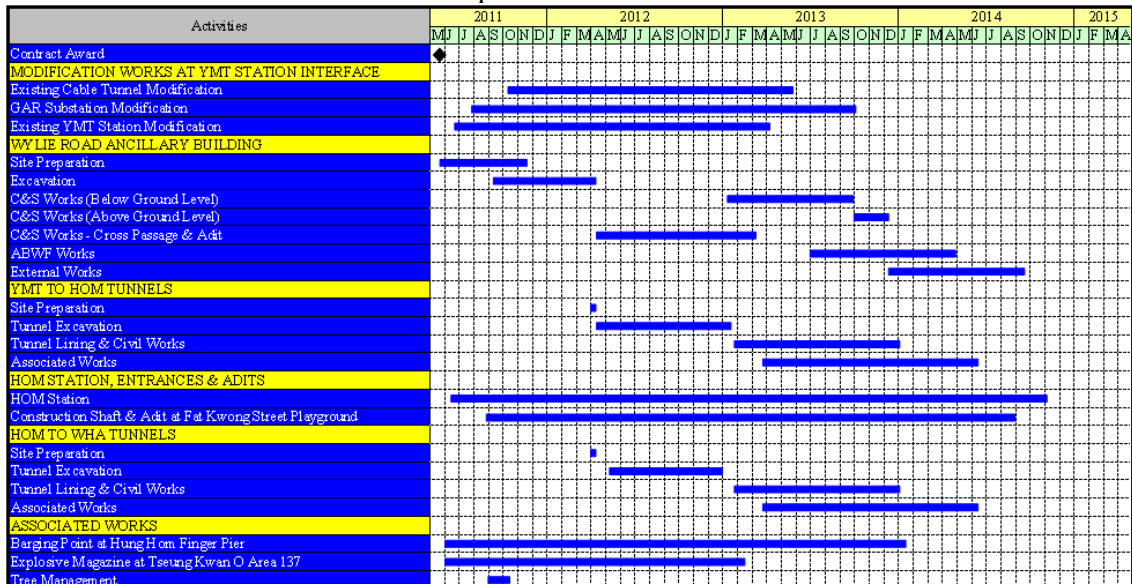

Contract 1002 – Kwun Tong Line Extension Whampoa Station and Overrun Tunnel

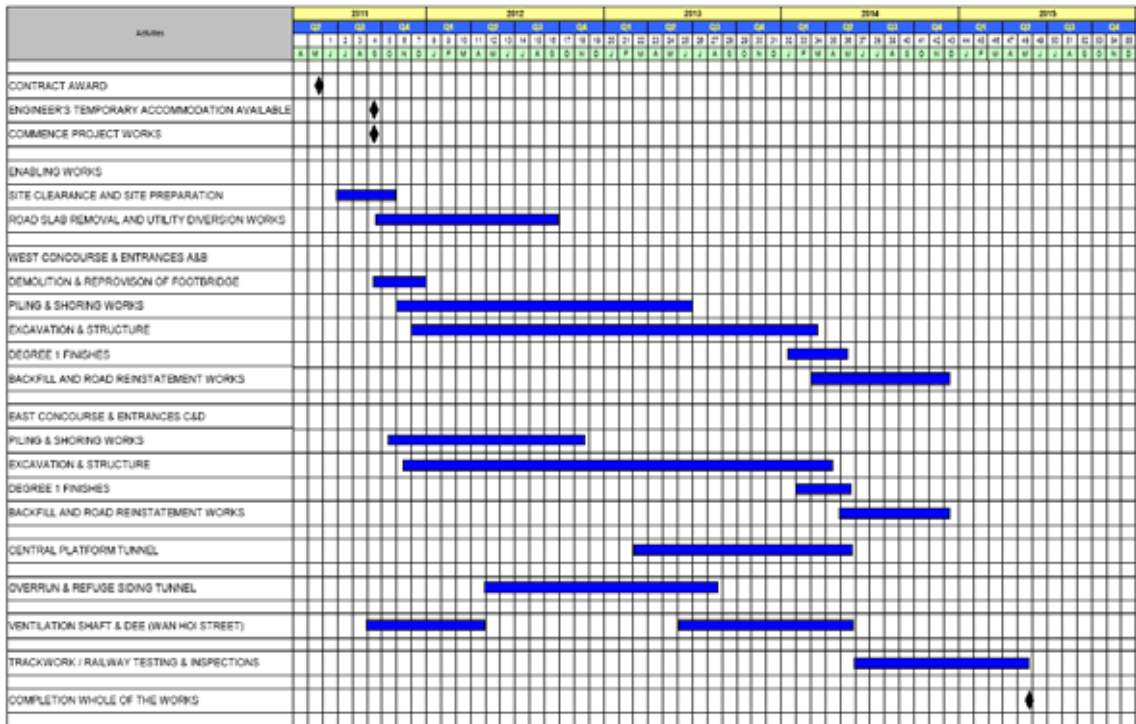

1.3 Coverage of the EM&A Report

The EM&A programme for the Kwun Tong Line Extension (KTE) Project commenced on 20 June 2011. This is the 38th Monthly Environmental Monitoring and Audit (EM&A) Report for the Project. The Report presents the results of EM&A works and the impact monitoring for the construction works undertaken by respective Contractors during the period of 1 August 2014 to 31 August 2014.

2 PROJECT INFORMATION

2.1 Project Management Organization and Contact Details

The KTE Project organization chart is presented in Figure 1. Contacts of key environmental personnel of the Project are shown in Tables 1a, 1b and 1c respectively.

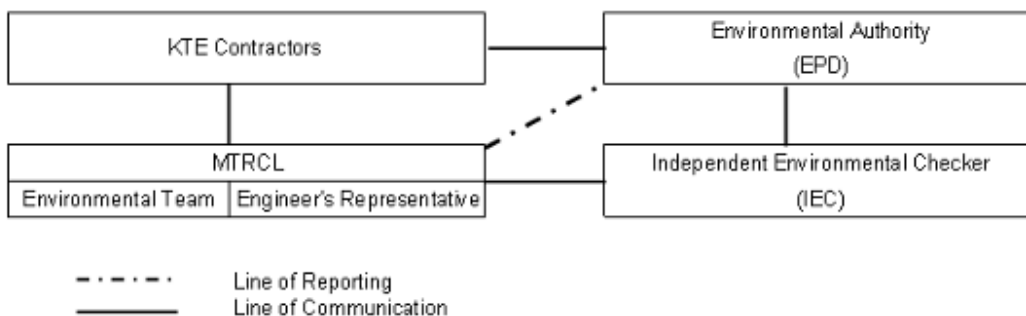

Figure 1. Project Organization

Table 1a Contact List of Key Personnel for Project Management

Organization	Name	Telephone
Engineer's Representative		
Project Manager	James Chow	2163 6283
Construction Manager	Kenny Kong	3441 3101
Construction Manager	Nelson Yeung	3940 3398
Independent Environmental Checker		
Consultant – Arup	Jacky Chan	3447 6292
Environmental Team		
Environmental Team Leader	Richard Kwan	2688 1179
Contact 1001 Contractor		
Project Manager	Colin Birkby	9641 2485
Environmental Officer	Ricky Tse	9221 0368
Contact 1002 Contractor		
Project Manager	Eric Wu	2743 3711
Environmental Officer	Leo Cheng	9779 7042
Environmental Officer	Andy Choy	6278 2693

Table 1b Contact List of Environmental Authority

Organization	Name	Telephone
Environmental Protection Department		
Sr Env Protection Offr(Metro Assessment) 2	Colin Keung	2835 1125
Sr Env Protection Offr(Regional E) 6	PS Ng	2150 8002
Sr Env Protection Offr(Regional E) 5	Alfred Ng	2117 7538
Sr Env Protection Offr(Regional E) 4	Aaron Lui	2117 7502

2.2 Project Works Sites and Areas and Environmental Monitoring Locations

The KTE Project works sites and areas are summarized in Table 2 below and shown in Appendix A Figures 1 to 8. The locations of environmental monitoring stations are indicated in Appendix A Figures 2 to 8. Table 3 shows the details of the active monitoring stations as reported in Sections 3.1 and 3.2.

Table 2 Summary of KTE Project Works Sites and Areas

Contract 1001 Works Sites and Areas	
Works Site A	Gascoigne Road Rest Garden
Works Site B	Underground Tunnel between Yau Ma Tei Station and Wylie Road Ancillary Building
Works Site C	Wylie Road Ancillary Building
Works Site D	Underground Tunnel between Wylie Road Ancillary Building and Ho Man Tin Station
Works Site E	Ho Man Tin Station
Works Site F	Fat Kwong Street Playground
Works Site G	Underground Tunnel between Ho Man Tin Station and Whampoa Station
Works Area J	Finger Pier Barging Point
Works Area K	Tseung Kwan O Area 137 Magazine Site

Contract 1002 Works Sites and Areas	
Works Site H	Whampoa Station West Concourse
Works Site I	Whampoa Station East Concourse
Works Area L	Hung Lok Road Site Office

Table 3 Summary of impact air quality and noise monitoring stations

ID	Monitoring Station
Air	
CD1a##	Methodist School
CD2a #	PolyU Homantin Student Halls of Residence
CD3a	No. 238 Chatham Road North
CD4a	Ka Fu Building, Whampoa Estate
CD5	Fung Kei Millennium Primary School
CD6a####	Site boundary of Finger Pier adjacent to Harbourfront Horizon
Noise	
CN1	Alhambra Building
CN2	Methodist College
CN3a##	Methodist School
CN4a #	PolyU Homantin Student Halls of Residence

ID	Monitoring Station
CN5*	Caritas Bianchi College of Careers
CN6	Lok Do Building
CN7	Block Y, Ki Fu Building, Whampoa Estate
CN8	Block I, Lok Wah Building, Whampoa Estate
CN9	Block 13, Bauhinia Mansions, Whampoa Garden Site 11
CN10	Block 1, Oak Mansions, Whampoa Garden Site 5
CN11	Fung Kei Millennium Primary School
CN12	GCEPSA Whampoa Primary School

Notes:

*: Alternative monitoring locations were proposed in the Alternative Proposal which was submitted on 14 Apr 2011 and agreed by the Environmental Protection Department on 29 Apr 2011. The noise monitoring location at Caritas Bianchi College of Careers, which has been relocated to Tiu Keng Leng with the original premise unoccupied and inaccessible, is suspended until the premises are occupied by similar educational use. No noise monitoring will be conducted for CN5.

#: Access to the original monitoring stations CD2 and CN4 (Yee Fu Building) has been denied by the management office since December 2012 and MTRCL proposed PolyU Homantin Student Halls of Residence as alternative monitoring stations with no objection from EPD on 28 February 2013.

##: Access to the original monitoring stations CD1 and CN3 (Queen Elizabeth Hospital – Specialist Clinic) has been denied for demolition since end of July 2013 and MTRC proposed Methodist School at Wylie Road as alternative monitoring stations with no objection from EPD on 4 September 2013.

###: As all KTE related construction works at Finger Pier was completed by end December 2013 and the site will be handed over to other project under MTR, the CD6a has been terminated starting from January 2014. EPD has no objection on the termination proposal on 29 January 2014.

2.3 Summary of EM&A Requirements

The EM&A programme mainly requires environmental monitoring for air quality, noise, landscape and visual, water quality and waste management as specified in the EM&A Manual.

A summary of impact EM&A requirements as applicable to this EM&A Report is presented in Table 4 below.

Table 4 Summary of impact EM&A Requirements

Parameters	Descriptions	Locations	Monitoring Frequencies	Duration
Air Quality	24-hr TSP	Shown in Table 3	Once per 6 days	Construction stage
Noise	$L_{eq(30min)}$	Shown in Table 3	Once a week	Construction stage

Parameters	Descriptions	Locations	Monitoring Frequencies	Duration
Landscape and visual	On-Site Audit	Active Works Sites	Bi-weekly	Construction stage
Waste	On-Site Audit	Active Works Sites	Weekly	Construction stage
Wastewater	On-Site Audit	Active Works Sites	Weekly and in accordance to the discharge licences	Construction stage
General Site Conditions	Environmental Site Inspection	Active Works Sites	Weekly	Construction stage

Environmental Quality Performance Limits for air quality and noise are shown in **Appendix B**. The Event Action Plan for air quality and noise are shown in **Appendix C**.

2.4 Implementation of Environmental Mitigation Measures

The KTE Civil Works Contractors are required to implement the mitigation measures as specified in the EP, EIA Report and EM&A Manual. During the regular environmental site inspections, the Contractors' implementation of mitigation measures were inspected and reviewed. A schedule of the implementation of mitigation measures identified in the KTE EIA is given in **Appendix D**.

2.5 Construction Activities in the Reporting Month

Major construction activities carried out by the respective KTE Civil Works Contractors during the reporting period include:

Contract 1001 - Works Sites and Areas

Works Site A (Gascoigne Road Rest Garden)

- General works
- Rails track installation

Works Site B (Underground Tunnel between Yau Ma Tei Station and Wylie Road Ancillary Building)

- Waterproofing and concrete lining works and invert concrete

Works Site C (Wylie Road Ancillary Building)

- Excavation of main tunnel
- Mucking out for tunnel excavation
- Center wall installation

Works Site D (Underground Tunnel between Wylie Road Ancillary Building and Ho Man Tin Station)

- Tunnel excavation
- Waterproofing and concrete lining works

Works Site E (Ho Man Tin Station)

- Concreting
- Superstructure of HOM station
- Pipes installation

Works Site F (Fat Kwong Street Playground)

- Waterproofing and concrete lining works and invert concrete

Works Site G (Underground Tunnel between Ho Man Tin Station and Whampoa Station)

- Waterproofing and concrete lining works and invert concrete

Works Area J (Hung Hom Barging Point)

- All works related to KTE project completed

Works Area K (Tseung Kwan O Area 137 Magazine Site)

- Nil

Contract 1002 - Works Sites and Areas

Works Site H (Whampoa Station West Concourse)

- Excavation and shotcreting
- Bulk excavation under traffic deck
- Underground utilities supporting beam installation
- Underground utilities window grouting
- ELS construction
- Concreting

Works Site I (Whampoa Station East Concourse)

- UC installation
- Excavation and shotcreting
- Bulk excavation under traffic deck
- UU supporting beam installation
- ELS construction
- Concreting

Works Area L (Hung Lok Road Site Office)

- Nil

2.6 Construction Activities for the Coming Month

According to the construction programme for the Civil Works Contracts, the scheduled major construction activities in the next reporting month are as follows:

Contract 1001 - Works Sites and Areas

Works Site A (Gascoigne Road Rest Garden)

- General works
- Rails track installation

Works Site B (Underground Tunnel between Yau Ma Tei Station and Wylie Road Ancillary Building)

- Waterproofing and concrete lining works and invert concrete

Works Site C (Wylie Road Ancillary Building)

- Excavation of main tunnel
- Mucking out for tunnel excavation
- Center wall installation

Works Site D (Underground Tunnel between Wylie Road Ancillary Building and Ho Man Tin Station)

- Tunnel excavation
- Waterproofing and concrete lining works

Works Site E (Ho Man Tin Station)

- Concreting
- Superstructure of HOM station
- Pipes installation

Works Site F (Fat Kwong Street Playground)

- Waterproofing and concrete lining works and invert concrete

Works Site G (Underground Tunnel between Ho Man Tin Station and Whampoa Station)

- Waterproofing and concrete lining works and invert concrete

Works Area J (Hung Hom Barging Point)

- All works related to KTE project completed

Works Area K (Tseung Kwan O Area 137 Magazine Site)

- Nil

Contract 1002 - Works Sites and Area

Works Site H (Whampoa Station West Concourse)

- Excavation and shotcreting
- Bulk excavation under traffic deck
- Underground utilities supporting beam installation
- Underground utilities window grouting
- ELS construction
- Concreting

Works Site I (Whampoa Station East Concourse)

- UC installation
- Excavation and shotcreting
- Bulk excavation under traffic deck
- UU supporting beam installation
- ELS construction
- Rebar fixing
- Concreting
- Form work and False Work

Works Area L (Hung Lok Road Site Office)

- Nil

3 **IMPACT MONITORING**

3.1 **Air Quality**

24-Hour TSP Levels Monitoring

The sampling procedure follows that described in the App. B of Pt 50 in 40CFR Ch.1 (U.S. Environmental Protection Agency). TSP is sampled by drawing air through a conditioned, pre-weighed filter paper inside the high volume sampler at a controlled rate. After 24-hour sampling the filter paper with retained particles is collected and returned to the laboratory for drying in a desiccator followed by weighing. TSP levels are calculated from the ratio of the mass of particulate retained on the filter paper to the total volume of air sampled.

The samplers should be properly maintained. Prior to dust monitoring commencing, appropriate checks should be made to ensure that all equipment and necessary power supply are in good working condition.

Calibration Requirements

The flow rate of the high volume sampler with mass flow controller will be calibrated using an orifice calibrator. Initial calibration (five points) will be conducted upon installation and prior to commissioning. Calibration will be carried out every six months. Calibration certificates are attached in **Appendix E**.

To examine the construction dust levels, 24-hour TSP monitoring was undertaken according to the EM&A Manual. The dust monitoring locations are shown in the Section 2.2 above.

Monitoring results are presented in the following table and **Appendix F** for graphical plot. The 24-hour TSP monitoring results in the range from 18.0 to 58.1 $\mu\text{g}/\text{m}^3$ recorded in the monitoring period shows that the dust levels generated by the active construction activities were within the Action Levels.

CD1a Methodist School					
Date	TSP (µg/m3)	Action Level (µg/m3)	Limit Level (µg/m3)	Compliance (Yes /No)	Weather Condition
08/08/2014	58.1	171	260	Yes	Cloudy
14/08/2014	22.7	171	260	Yes	Rainy
20/08/2014	47.9	171	260	Yes	Rainy
28/08/2014	31.3	171	260	Yes	Rainy
CD2a PolyU Homantin Student Halls of Residence					
Date	TSP (µg/m3)	Action Level (µg/m3)	Limit Level (µg/m3)	Compliance (Yes /No)	Weather Condition
08/08/2014	44.2	183	260	Yes	Cloudy
14/08/2014	18.0	183	260	Yes	Rainy
20/08/2014	28.8	183	260	Yes	Rainy
28/08/2014	40.3	183	260	Yes	Rainy
CD3a No.238 Chatham Road North					
Date	TSP (µg/m3)	Action Level (µg/m3)	Limit Level (µg/m3)	Compliance (Yes /No)	Weather Condition
04/08/2014	28.0	192	260	Yes	Rainy
09/08/2014	30.0	192	260	Yes	Rainy
15/08/2014	22.7	192	260	Yes	Sunny
21/08/2014	31.4	192	260	Yes	Rainy
27/08/2014	35.5	192	260	Yes	Rainy
CD4a Ka Fu Building, Whampoa Estate					
Date	TSP (µg/m3)	Action Level (µg/m3)	Limit Level (µg/m3)	Compliance (Yes /No)	Weather Condition
08/08/2014	53.2	187	260	Yes	Cloudy
14/08/2014	43.7	187	260	Yes	Rainy
20/08/2014	51.2	187	260	Yes	Rainy
26/08/2014	57.0	187	260	Yes	Sunny
CD5 Fung Kei Millennium Primary School					
Date	TSP (µg/m3)	Action Level (µg/m3)	Limit Level (µg/m3)	Compliance (Yes /No)	Weather Condition
08/08/2014	52.1	168	260	Yes	Cloudy
14/08/2014	33.4	168	260	Yes	Rainy
20/08/2014	32.7	168	260	Yes	Rainy
26/08/2014	35.3	168	260	Yes	Sunny

3.2 Noise

B&K 2250 sound level meters which complied with the International Electrotechnical Commission Publication 651:1979 (Type 1) and 804:1985 (Type 1), specification as referred to in the Technical Memoranda to the NCO were used for the construction noise impact monitoring. The B&K sound level meter and B&K 4231 calibrator are verified by the certified laboratory or manufacturer once every two years to ensure they perform to the same level of accuracy as stated in the manufacturer's specifications. In this reporting period, sound level meter with serial number 2704791 was used. All relevant calibration certificates are attached in **Appendix E**.

Immediately prior to and following each set of measurements at any NSR, the accuracy of the sound level meter was checked using an acoustic calibrator generating a known sound pressure level at a known frequency. If the calibration levels before and after the measurement differs by more than 1.0dB the measurement shall be repeated to obtain a reliable result. Periods of prolonged or repeated overloading of the sound level meter detector were avoided by setting the meter with adequate headroom prior to commencing measurements. Measurements were recorded to the nearest whole dB, with values of 0.5 or more being rounded up.

Impact noise monitoring of $L_{Aeq(30min)}$ was undertaken to measure construction noise levels in accordance with the EM&A Manual. The noise monitoring locations are shown in Section 2.2 above.

The monitoring results corrected to the baselines in the range from 51 to 74 dB(A) are presented in the following table and **Appendix F** for graphical plot.

CN1- Alhambra building								
Date	Time	Measured Leq(dBA)	Baseline Leq (dBA)	Corrected Leq(dBA)#	Limit Level (dBA)	Exceedance of Limit Level	Residual Level (dBA)##	Exceedance of Residual Level
07/08/2014	11:30	68	71	***	75	No	-	-
11/08/2014	17:00	68	71	***	75	No	-	-
15/08/2014	16:00	69	72	***	75	No	-	-
25/08/2014	11:30	70	71	***	75	No	-	-
CN2- Methodist College								
Date	Time	Measured Leq(dBA)	Baseline Leq (dBA)	Corrected Leq(dBA)#	Limit Level (dBA)	Exceedance of Limit Level	Residual Level (dBA)##	Exceedance of Residual Level
07/08/2014	10:30	74	75	***	70	No	75	No
11/08/2014	15:00	74	76	***	70	No	75	No
15/08/2014	15:00	76	76	***	70	No	75	No
25/08/2014	10:30	76	75	68	70	No	75	No
CN3a - Methodist School								
Date	Time	Measured Leq(dBA)	Baseline Leq (dBA)	Corrected Leq(dBA)#	Limit Level (dBA)	Exceedance of Limit Level	Residual Level (dBA)##	Exceedance of Residual Level
08/08/2014	16:30	68	64	65	70	No	-	-
11/08/2014	13:30	69	64	67	70	No	-	-
15/08/2014	14:00	70	64	69	70	No	-	-
25/08/2014	9:30	67	63	65	70	No	-	-
CN4a - PolyU Homantin Student Halls of Residence								

Date	Time	Measured Leq(dBA)	Baseline Leq (dBA)	Corrected Leq(dBA)#	Limit Level (dBA)	Exceedance of Limit Level	Residual Level (dBA)##	Exceedance of Residual Level
08/08/2014	15:00	67	-	-	75	No	77	No
11/08/2014	10:30	68	-	-	75	No	77	No
15/08/2014	11:30	70	-	-	75	No	77	No
25/08/2014	16:00	70	-	-	75	No	77	No
CN6- Lok Do Building								
Date	Time	Measured Leq(dBA)	Baseline Leq (dBA)	Corrected Leq(dBA)#	Limit Level (dBA)	Exceedance of Limit Level	Residual Level (dBA)##	Exceedance of Residual Level
07/08/2014	15:30	72	71	67	75	No	-	-
11/08/2014	9:30	71	71	62	75	No	-	-
15/08/2014	10:00	70	71	***	75	No	-	-
25/08/2014	15:00	71	71	62	75	No	-	-
CN7- Block Y, Ki Fu Building, Whampoa Estate								
Date	Time	Measured Leq(dBA)	Baseline Leq (dBA)	Corrected Leq(dBA)#	Limit Level (dBA)	Exceedance of Limit Level	Residual Level (dBA)##	Exceedance of Residual Level
05/08/2014	15:00	71	71	***	75	No	83	No
11/08/2014	14:00	72	71	66	75	No	83	No
21/08/2014	9:30	70	71	***	75	No	83	No
28/08/2014	16:00	72	71	62	75	No	83	No
CN8- Block I, Lok Wah Building, Whampoa Garden								
Date	Time	Measured Leq(dBA)	Baseline Leq (dBA)	Corrected Leq(dBA)#	Limit Level (dBA)	Exceedance of Limit Level	Residual Level (dBA)##	Exceedance of Residual Level
05/08/2014	14:00	73	69	71	75	No	81	No
11/08/2014	15:00	74	70	72	75	No	81	No
21/08/2014	10:30	71	69	67	75	No	81	No
28/08/2014	14:00	71	69	66	75	No	81	No
CN9- Block 13, Bauhinia Mansions, Whampoa Garden Site 11								
Date	Time	Measured Leq(dBA)	Baseline Leq (dBA)	Corrected Leq(dBA)#	Limit Level (dBA)	Exceedance of Limit Level	Residual Level (dBA)##	Exceedance of Residual Level
05/08/2014	9:00	72	69	68	75	No	79	No
11/08/2014	13:00	74	69	72	75	No	79	No
21/08/2014	15:00	72	71	65	75	No	79	No
28/08/2014	9:00	75	69	73	75	No	79	No
CN10- Block 1, Oak Mansions, Whampoa Garden Site 5								
Date	Time	Measured Leq(dBA)	Baseline Leq (dBA)	Corrected Leq(dBA)#	Limit Level (dBA)	Exceedance of Limit Level	Residual Level (dBA)##	Exceedance of Residual Level
05/08/2014	10:00	74	66	74	75	No	82	No
11/08/2014	9:00	73	66	72	75	No	82	No
21/08/2014	11:30	72	66	71	75	No	82	No
28/08/2014	10:00	74	66	73	75	No	82	No
CN11- Fung Kei Millennium Primary School								
Date	Time	Measured Leq(dBA)	Baseline Leq (dBA)	Corrected Leq(dBA)#	Limit Level (dBA)	Exceedance of Limit Level	Residual Level (dBA)##	Exceedance of Residual Level
05/08/2014	11:00	71	64	70	70	No	78	No
11/08/2014	11:00	70	64	68	70	No	78	No
21/08/2014	13:00	71	65	70	70	No	78	No
28/08/2014	11:00	69	64	67	70	No	78	No
CN12- GCEPSA Whampoa Primary School								

Date	Time	Measured Leq(dBA)	Baseline Leq (dBA)	Corrected Leq(dBA)#	Limit Level (dBA)	Exceedance of Limit Level	Residual Level (dBA)##	Exceedance of Residual Level
05/08/2014	13:00	67	66	60	70	No	76	No
11/08/2014	10:00	66	65	56	70	No	76	No
21/08/2014	14:00	64	64	51	70	No	76	No
28/08/2014	13:00	65	66	***	70	No	76	No

Notes:

It is noted that all noise monitoring were not undergone in the raining period. The weather condition is fine and with wind speed < 2m/s. Decimal point of measured and baseline monitoring data is used to calculate the corrected noise level.

The Measured Leq is corrected against the corresponding Baseline Level.

*** Refers to the Measured Leq is lower than the Baseline Level.

Residual Level refers to the maximum predicted construction noise levels in the EIA report when residual impact is anticipated.

3.3 Action taken in Event of Exceedance

No exceedance was recorded for both TSP and construction noise monitoring in this reporting period.

4 LANDSCAPE AND VISUAL

4.1 Monitoring Requirements

Monitoring of the implementation of the landscape and visual mitigation measures during construction phase was conducted in accordance with the requirements as stipulated in the EM&A Manual.

The landscape and visual monitoring and audit will be conducted once every two weeks throughout the construction stage.

4.2 Audit Results

Monitoring and audit was undertaken in accordance with the EM&A Manual.

Tree Felling at Contract 1001 Works Sites / Areas

No tree related to KTE project was felled during this reporting month.

Tree Felling at Contract 1002 Works Sites / Areas

No tree related to KTE project was felled during the reporting month.

Tree Transplantation in this reporting period for Contract 1001

No tree related to KTE project was transplanted during the reporting month.

Tree Transplantation in this reporting period for Contract 1002

No tree related to KTE project was transplanted during the reporting month.

Bi-weekly inspection

The Registered Landscape Architect of Environmental Team or his representatives conducted inspections and audits and the tree protection works being planned and implemented by the respective contractors of Contract 1001 and 1002 were in progress. No non-conformance was identified in the reporting period.

4.3 Action Taken in Event of Non-Conformance

No actions on landscape and visual were required to be taken in this reporting period.

5 WASTE MANAGEMENT

Mitigation measures on waste management have been implemented in accordance with the requirements of the EM&A Manual. Suitable C&D materials were reused on-site or at other projects such as Andersen Road Quarry while the remaining C&D materials and non-inert wastes were disposed at the public filling reception facilities and the landfills respectively. The quantities disposed in the reporting period are summarized in the following table:

Amount of Construction Wastes Disposed				
Reporting Period	Inert C&D Materials to Public Fill (m ³)	Inert C&D Materials Reused (m ³)	Non-inert Waste to Landfill (m ³)	Chemical Waste to designated treatment facility (trips)
Contract 1001				
Jun -Dec 2011	28690	24768	714	0
Jan-Dec 2012	40393	415640	1614	2
Jan – Dec 2013	75176	317190	2544	7
January 2014	4414	20419	420	1
February 2014	6100	15246	306	0
March 2014	6193	24697	438	1
April 2014	3907	19826	432	0
May 2014	4083	17242	606	0
June 2014	5948	8568	630	1
July 2014	4615	7918	708	0
August 2014	2368	5378	738	1
Subtotal	181887	876892	9150	13
Contract 1002				
June-December 2011	3037	0	9	0
Jan – Dec 2012	14484	68	252	5
Jan – Dec 2013	45017	60	127	0
January 2014	6741	5	12	0
February 2014	12956	5	7	0
March 2014	5238	290	6	1

April 2014	8329	873	3	0
May 2014	15311	1152	7	0
June 2014	20680	431	31	0
July 2014	25041	542	33	0
August 2014	23785	1308	15	0
Subtotal	156834	3426	4487	6
Overall Total	362506	881626	9652	19

6 WATER QUALITY

Monitoring of the implementation of the water quality mitigation measures during construction phase was conducted in accordance with the requirements as stipulated in the EM&A Manual.

Weekly site inspection will be conducted throughout the construction stage covering the entire project site areas to ensure the recommended mitigation measures are properly implemented.

In the reporting period, the water quality mitigation measures were implemented in accordance with the requirements as stipulated in the EM&A Manual for contract 1001 and found in an acceptable manner. A non-compliance regarding site water management issue was recorded for contract 1002 and the mitigation measures need to be improved. Details of the non-compliance refer to section 8.

Water sample test were conducted for Works Sites C, E, F in August 2014. Analytical results will be reported in accordance to WPCO licenses.

7 RECORD OF ENVIRONMENTAL COMPLAINTS

No complaint was received in this reporting period.

A summary of complaint received since commencement of the project is shown at below.

Reporting Period	Invalid Complaint			Valid Complaint		
	Frequency	Nature	Status	Frequency	Nature	Status
June 2011	0	N/A	N/A	0	N/A	N/A
July 2011	0	N/A	N/A	0	N/A	N/A
August 2011	0	N/A	N/A	0	N/A	N/A
September 2011	1	Noise	Closed	0	N/A	N/A
October 2011	0	N/A	N/A	0	N/A	N/A
November 2011	0	N/A	N/A	1	Dust	Closed
December 2011	1	Water	Closed	0	N/A	N/A
January 2012	0	N/A	N/A	0	N/A	N/A
February 2012	1	Noise	Closed	1	Noise	Closed
March 2012	2	Noise & Dust	Closed	2	Noise	Closed
April 2012	1	N/A	N/A	1	Noise	Closed
May 2012	1	Water	Closed	0	N/A	N/A
June 2012	3	Noise & Dust	Closed	3	Noise	Closed
July 2012	0	N/A	N/A	0	N/A	N/A
August 2012	2	Noise & Odor	Closed	0	N/A	N/A
September 2012	1	Air	Closed	0	N/A	N/A
October 2012	2	Noise	Closed	0	N/A	N/A
November 2012	2	Noise & Odor	Closed	1	Noise	Closed
December 2012	0	N/A	N/A	0	N/A	N/A
January 2013	0	N/A	N/A	1	Visual	Closed
February 2013	0	N/A	N/A	0	N/A	N/A
March 2013	1	Noise	Closed	0	N/A	N/A
April 2013	0	N/A	N/A	0	N/A	N/A
May 2013	0	N/A	N/A	0	N/A	N/A
June 2013	0	N/A	N/A	0	N/A	N/A
July 2013	0	N/A	N/A	0	N/A	N/A
August 2013	0	N/A	N/A	0	N/A	N/A
September 2013	0	N/A	N/A	0	N/A	N/A
October 2013	0	N/A	N/A	0	N/A	N/A
November 2013	0	N/A	N/A	0	N/A	N/A
December 2013	0	N/A	N/A	0	N/A	N/A
January 2014	0	N/A	N/A	0	N/A	N/A
February 2014	0	N/A	N/A	0	N/A	N/A
March 2014	1	Noise	Closed	0	N/A	N/A
April 2014	1	Noise	Closed	0	N/A	N/A
May 2014	1	Noise	Closed	1	Fume	Closed
June 2014	0	N/A	N/A	1	Fume	Closed
July 2014	0	N/A	N/A	1	Fume	Closed
August 2014	0	N/A	N/A	0	N/A	N/A
Cumulative	21	N/A	N/A	13	N/A	N/A

8 RECORD OF NON-COMPLIANCES

A non-compliance regarding site water management issue was issued by ET on 21 August 2014 to 1002 contractor regarding non-compliance observed in Whampoa Station works site in Man Siu Street on 20 August 2014. IEC informed EPD for the issue of non-compliance on 22 August 2014 as per EP requirement.

A weekly inspection with representatives from ET, IEC, ER and Contractor was performed on 20 August 2014 and observed that there was no satisfactory follow up actions taken to implement proper wastewater treatment to handle wastewater arisen from construction works. Sedimentation tanks provided at sites were in major breakdown that site water diverted into the tanks was unable to be treated effectively to fulfill with requirements specified in the Water Pollution Control Ordinance (WPCO)

discharge license.

Subject to the non-compliance event, the Contractor prepared an investigation report as well as the mitigation proposal and agreed to rectify the deficiency to ensure discharged effluent complying with the discharge license. Rectification works including, but not limited to, provision of additional sedimentation tanks, maintenance to the existing sedimentation tanks, and provision of designated competent persons for checking and servicing the site water treatment facilities at sites, would be implemented to address the non-compliance.

9 NOTIFICATION OF SUMMONS AND SUCCESSFUL PROSECUTIONS

No summon or prosecution related to environmental issue was recorded in the reporting period. A summary of environmental prosecution since commencement of construction is shown below:-

Reporting Period	Frequency	Cumulative	Nature	Status
June – December 2011	0	0	N/A	N/A
January – June 2012	0	0	N/A	N/A
July – December 2012	0	0	N/A	N/A
January - June 2013	0	0	N/A	N/A
July – December 2013	0	0	N/A	N/A
January – June 2014	0	0	N/A	N/A
July 2014	0	0	N/A	N/A
August 2014	0	0	N/A	N/A
Cumulative	0	0	N/A	N/A

10 STATUS OF STATUTORY SUBMISSIONS

10.1 Submissions required under Environmental Permit

A summary of the status of submissions required under the KTE Environmental Permit as of 31 August 2014 is shown below:

EP-399/2010/A Part C Clause No.		Description	Status
1.12	1	Notification of commencement of construction	Submitted on 17 May 2011
2.1	2	Establishment of ET with ET Leader	Submitted on 1 April 2011
2.1	3	Establishment of Registered Landscape Architect	Submitted on 14 April 2011
2.2	4	Employment of IEC	Submitted on 1 April 2011 and 7 July 2011
2.3	5	Notification of the management organization of main construction companies and/or any form of JV	Submitted on 19 May 2011
2.4	6	Layout drawings with explanatory statement, showing Project boundary, alignment and associated work areas and works sites locations	Submitted on 10 June 2011 and 13 July 2011
2.5	7	Notification of setting up hotline to service complaints, comments, suggestions or requests for information	Submitted on 12 May 2011
3.7	8	Report any contamination hotspot(s) identified from the reconnaissance site visit to the kerosene store at Chung Hau Street	Submitted on 25 July 2011
5.3	9	Submission of Baseline Monitoring Report	Submitted on 4 May 2011 and 8 July 2011
6.2	10	Notification of Internet address to place EM&A data	Submitted on 1 August 2011
5.4	11	Monitoring Report for July 2011	Submitted on 12 August 2011
5.4	12	Monitoring Report for August 2011	Submitted on 15 September 2011
5.4	13	Monitoring Report for September 2011	Submitted on 17 October 2011
4.1	14	Review Plan for Operational Groundborne Noise	Submitted on 28 October 2011
5.4	15	Monitoring Report for October 2011	Submitted on 14 November 2011
5.4	16	Monitoring Report for November 2011	Submitted on 14 December 2011
5.4	17	Monitoring Report for December 2011	Submitted on 16 January 2012
5.4	18	Monitoring Report for January 2012	Submitted on 14 February 2012
4.1	19	Review Plan for Operational Groundborne Noise	Submitted on 29 February 2012
5.4	20	Monitoring Report for February 2012	Submitted on 14 March 2012
5.4	21	Monitoring Report for March 2012	Submitted on 17 April 2012
4.1	22	Review Plan for Operational Groundborne Noise	Submitted on 27 April 2012
5.4	23	Monitoring Report for April 2012	Submitted on 15 May 2012
3.7	24	Further Inspection to the Kerosene Store	Submitted on 8 Jun 2012
5.4	25	Monitoring Report for May 2012	Submitted on 14 Jun 2012
2.4	26	Update of Layout drawings with explanatory statement, showing Project boundary, alignment and associated work areas and works sites locations	Submitted on 13 Jul 2012
5.4	27	Monitoring Report for Jun 2012	Submitted on 16 Jul 2012
5.4	28	Monitoring Report for Jul 2012	Submitted on 14 Aug 2012
4.9	29	Landscape and Visual Plan Part 1: Tseung Kwan O Area 137 Magazine Site	Submitted on 27 Aug 2012
5.4	30	Monitoring Report for Aug 2012	Submitted on 14 Sep 2012
5.4	31	Monitoring Report for Sep 2012	Submitted on 16 Oct 2012

4.9	32	Landscape and Visual Plan Part 1: Tseung Kwan O Area 137 Magazine Site Rev. A	Submitted on 24 Oct 2012
5.4	33	Monitoring Report for Oct 2012	Submitted on 14 Nov 2012
5.4	34	Monitoring Report for Nov 2012	Submitted on 14 Dec 2012
5.4	35	Monitoring Report for Dec 2012	Submitted on 14 Jan 2013
5.4	36	Monitoring Report for Jan 2013	Submitted on 19 Feb 2013
5.1	37	Proposal of Alternative Monitoring Locations from MTRCL	Submitted on 26 Feb 2013
5.4	38	Monitoring Report for Feb 2013	Submitted on 14 Mar 2013
5.4	39	Monitoring Report for Mar 2013	Submitted on 16 Apr 2013
5.4	40	Monitoring Report for April 2013	Submitted on 15 May 2013
5.4	41	Monitoring Report for May 2013	Submitted on 17 June 2013
2.1	42	Replacement of Registered Landscape Architect	Submitted on 3 July 2013
5.4	43	Monitoring Report for June 2013	Submitted on 15 July 2013
5.4	44	Monitoring Report for July 2013	Submitted on 14 Aug 2013
5.1	45	Proposal of Alternative Monitoring Locations from MTRCL	Submitted on 16 Aug 2013
5.4	46	Monitoring Report for August 2013	Submitted on 13 Sep 2013
5.4	47	Monitoring Report for September 2013	Submitted on 16 Oct 2013
5.4	48	Monitoring Report for October 2013	Submitted on 14 Nov 2013
5.4	49	Monitoring Report for November 2013	Submitted on 13 Dec 2013
5.4	50	Monitoring Report for December 2013	Submitted on 15 Jan 2014
5.1	51	Proposal for Termination of TSP Monitoring at CD6a Harbourfront Horizon	Submitted on 15 Jan 2014
5.4	52	Monitoring Report for January 2014	Submitted on 17 Feb 2014
5.4	53	Monitoring Report for February 2014	Submitted on 14 Mar 2014
4.1	54	Operational Groudborne Noise Review Plan	Submitted on 20 Mar 2014
4.2	55	Operational Groundborne Noise Review Report – Phase 1	Submitted on 20 Mar 2014
5.4	56	Monitoring Report for March 2014	Submitted on 14 Apr 2014
5.4	57	Monitoring Report for April 2014	Submitted on 19 May 2014
5.4	58	Monitoring Report for May 2014	Submitted on 16 June 2014
5.4	59	Monitoring Report for June 2014	Submitted on 15 July 2014
5.4	60	Monitoring Report for July 2014	Submitted on 14 August 2014
2.1	61	Replacement of Registered Landscape Architect	Submitted on 28 August 2014

10.2 Statutory Permits and Licenses

A summary of the status of all relevant environmental permits and licenses as of 31 August 2014 is shown below:

Description	License/ Permit Reference	Issue Date	Expired Date
Environmental Permit			
Environmental Permit for Kwun Tong Line Extension Project (EP-399/2010)	(EP-399/2010) (superseded by EP-399/2010/A)	27 September 2010	NA
Variation of Environmental Permit for Kwun Tong Line Extension Project	(EP-399/2010/A)) (superseded by EP-399/2010/B)	1 December 2010	NA
Variation of Environmental Permit for Kwun Tong Line Extension Project	(EP-399/2010/B)	7 June 2012	NA
Contract 1001			
Wastewater Discharge License	WT00009504-2011 (Works Site C),	14 July 2011	31 July 2016
	WT00009582-2011 (Works Site F),	27 July 2011	31 July 2016
	WT00009608-2011 (Works Site A),	1 August 2011	31 August 2016
	WT00009611-2011 (Works Area J)	9 August 2011	31 August 2016
	WT00012298-2012 (Works Site E)	19 April 2012	31 July 2016
Registration as a Chemical Waste Producer	5213-226-N2206-22 (Works Site A)	1 August 2011	NA
	5213-226-N2206-23 (Works Site C)	1 August 2011	NA
	5213-237-N2454-04 (Works Site E)	11 August 2011	NA
	5213-243-N2454-03 (Works Site F)	11 August 2011	NA
Disposal of Construction Waste	Billing Account no. 7012910 activated	26 May 2011	NA
Construction Noise Permit	GW-RE0311-14 (GAR)	21/03/2014	15/04/2014 To 14/10/2014
	GW-RE0761-14 (HOM)	08/07/2014	14/07/2014 To 13/01/2015
	GW-RE0364-14 (WAB)	31/3/2014	15/4/2014 To 14/10/2014
	GW-RE0036-14 (FKS)	11/07/2014	12/07/2014 To 03/01/2015
Contract 1002			

Wastewater Discharge License	WT00009415-2011 (Site office)	11 July 2011	30 Sep2016
	WT00010827-2011	8 December 2011	31 Oct 2016
Registration as a Chemical Waste Producer	Waste Producer No. 5213-245-C3672-01	16 June 2011	NA
Disposal of Construction Waste	Billing Account No. 7012934 activated	31 May 2011	NA
Construction Noise Permit	GW-RE0803-14 (MSS)	18/07/2014	23/07/2014 To 22/01/2015
	GW-RE0878-14 (TOS)	05/08/2014	11/08/2014 To 10/02/2015
	GW-RE0888-14 (WHS)	11/08/2014	22/08/2014 To 21/09/2014

11 SITE INSPECTIONS

11.1 Observations

Regular site inspections led by the Engineer's Representative and anticipated by ET and respective Contractors were undertaken in accordance with the EM&A Manual in the reporting period. The contractors' performance on environmental matters were assessed and found in an acceptable manner. The inspection findings and the associated recommendations on improvement to the environmental protection and pollution control works were raised to the contractors for reference and/ or action.

Observations against the implementation of the mitigation measures recommended in the EP/EIA are summarized as follows:

Item	Description	Follow-up Status
	Contract 1001	
1	The contractor was reminded to treat all wastewater prior to discharge and ensure the effluent compliance with WPCO requirements.	Completed
2	The contractor should remove the silt in the sedimentation tank regularly to ensure the sedimentation tank functions properly.	Completed
	Contract 1002	
1	Four sides of the air compressor should be screened with acoustic blanket	Completed
2	Earthy materials stockpiled next to the gully. Concerned gully should also be protected with proper bund walls to prevent surface runoff from directly entering into the public drainage system.	Completed
3	Earthy stockpile should be covered with tarpaulin sheets to prevent erosion from surface runoff	Completed
4	Contractor shall ensure components of all wastewater treatment facilities are in order such that they are capable of handling the wastewater arisen from site works.	Ongoing
5	Wastewater and muddy surface runoff without proper treatment were observed to be discharging into public drain during inspection. Contractor was request to implement necessary follow up actions to rectify the observations	NC event. Ongoing
6	Secondary containment measures shall be provided for chemicals occupied at site	Completed

The respective contractors have followed most of concerned items raised during the inspections for rectification in a responsible manner.

11.2 Other Notable Events

IEC Site Inspections

The IEC conducted site inspections for Works Areas on 19 August 2014 for Contract 1001. For Contract 1002, IEC conducted inspection on 5, 20 and 27 August 2014. Some observations listed in section 11.1 were noted during the site inspections and the respective Contractors had followed up the issues as identified in the site inspections in a responsible manner.

EPD Inspection

EPD conducted inspection at Whampoa area on 27 August 2014 and wastewater discharge samples were collection. The testing result is pending. CHJV was reminded to provide proper treatment system for the wastewater treatment before discharge.

12 FUTURE KEY ISSUES

12.1 Key Issues for the Coming Month

Future key issues envisaged in the coming month include the followings:

- Noise impact from operating equipment from site construction activities, e.g. pile/sheet piling and rock breaking works;
- Fugitive dust impact from cement mixing activities and rock breaking works;
- Effluent discharge generated from various construction works;

12.2 Effectiveness and Efficiency of Mitigation Measures

Based on the environmental monitoring results of the reporting period, the effectiveness and efficiency of most of the mitigation measures implemented were found to be satisfactory. For the non-compliance of site water management of Contract 1002 work sites, Contractor was seriously reminded to follow up with comments and advices given from ET and IEC without further delay. The respective contractors were reminded to carry out their future construction activities to comply with the requirements of the EP and the relevant contract requirements.

13 CONCLUSIONS

The Report presents the results of EM&A works and the impact monitoring for the construction works undertaken during the period of August 2014.

The major construction activities in the reporting period included temporary road & traffic diversion, bulk excavation, adit and tunnel excavation, soil nailing, ground improvement works and tunnel lining.

No exceedance was recorded for TSP and construction noise monitoring in this reporting month.

No complaint was received in this reporting month.

No notification of summon and prosecution were received in the reporting period. Regular site inspections led by the Engineer's Representative and anticipated by the representatives from ET and the respective Contractors' Team were conducted on a weekly basis to monitor the implementation of environmental pollution control and mitigation measures for the Project.

A non-compliance in related to site water management was identified in this reporting period. Details of the event and follow up actions proposed by Contractor are provided in Section 8 of the report.

It is concluded from the environmental monitoring and audit works for the Kwun Tong Line Extension Project were undertaken in a responsible manner. The environmental protection and pollution control measures provided by respective contractors of Contract 1001 and 1002 were generally acceptable apart from some minor irregularities which were rectified timely by the respective civil works contractors.

Appendix A

Figures

Figure 1. KTE Project Works Area

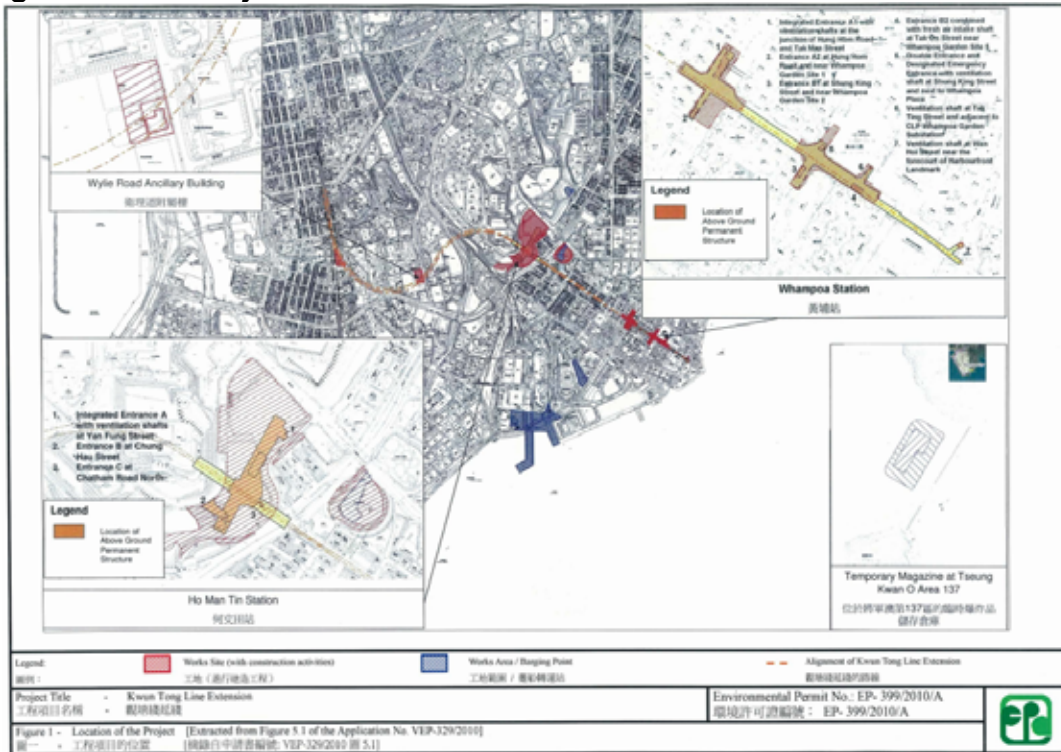

Figure 2. Location of Dust Monitoring Stations (CD1a)

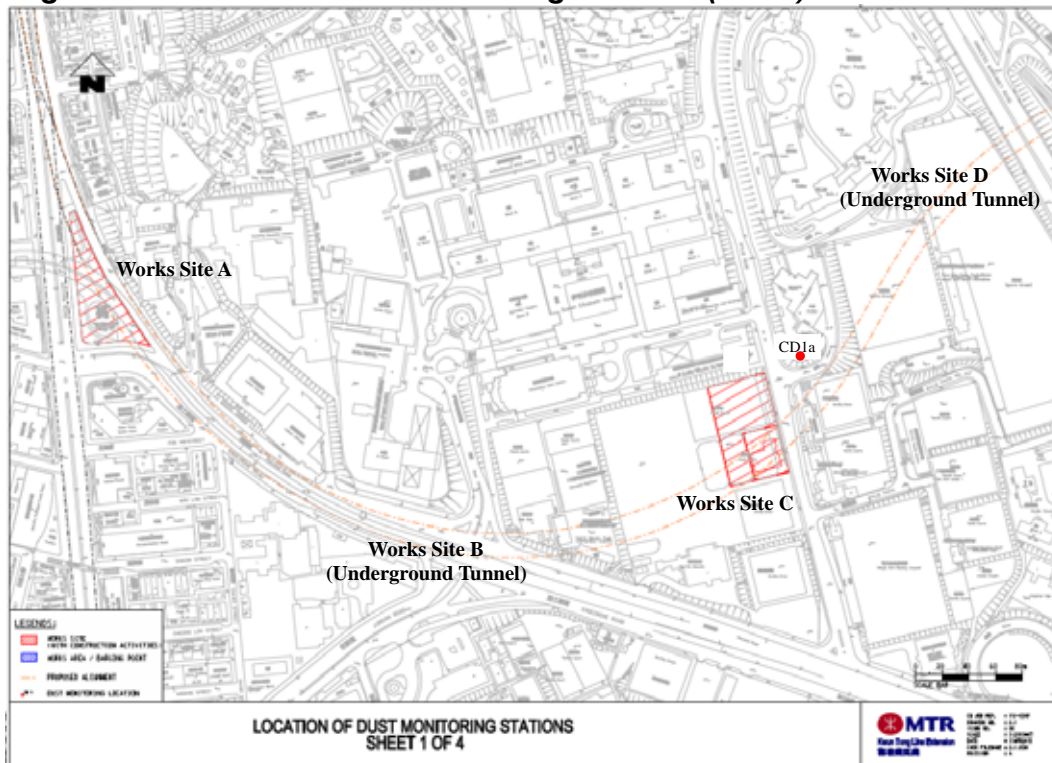

Figure 3. Location of Dust Monitoring Stations (CD2a and CD3a)

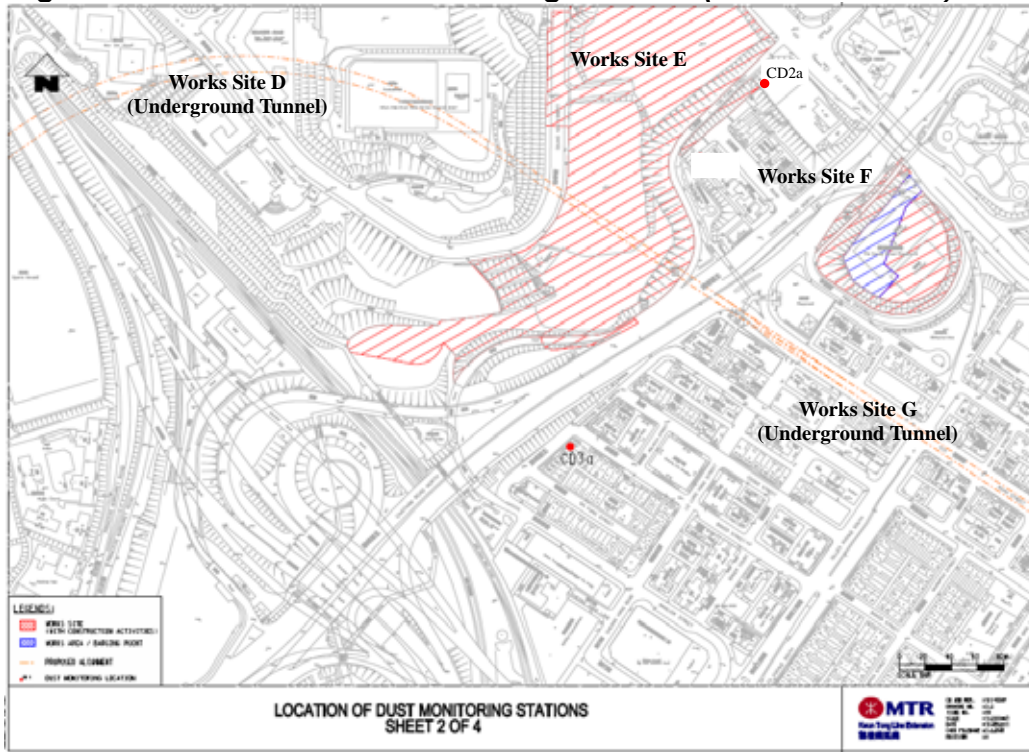

Figure 4. Location of Dust Monitoring Stations (CD4a and CD5)

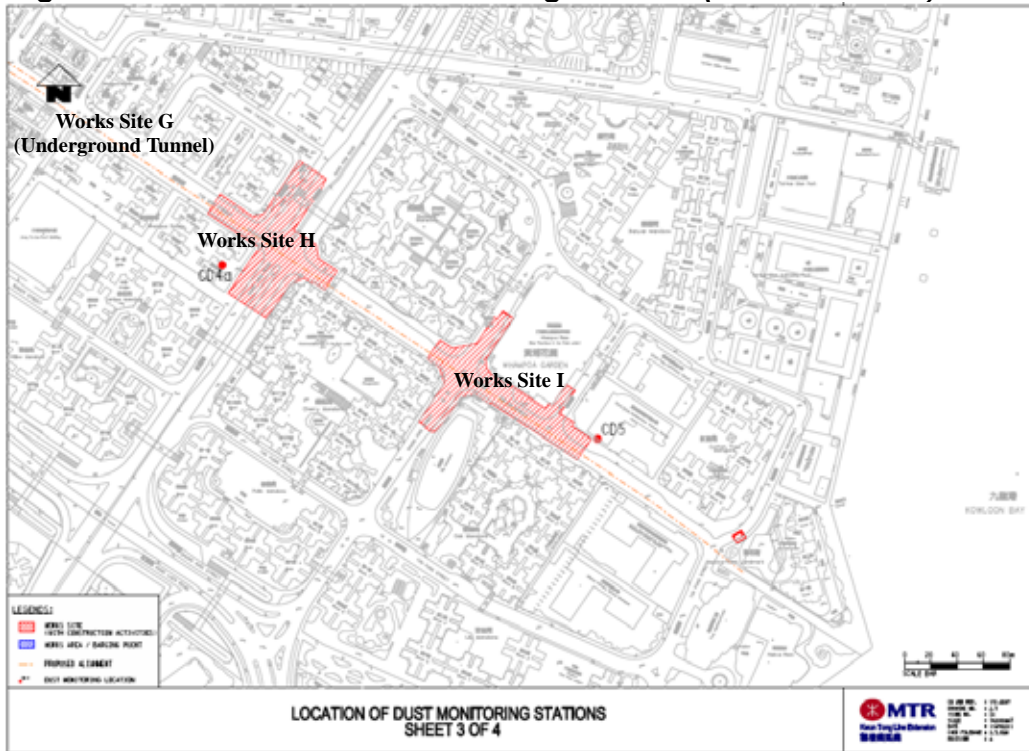

Figure 5. Location of Dust Monitoring Stations (CD6a)

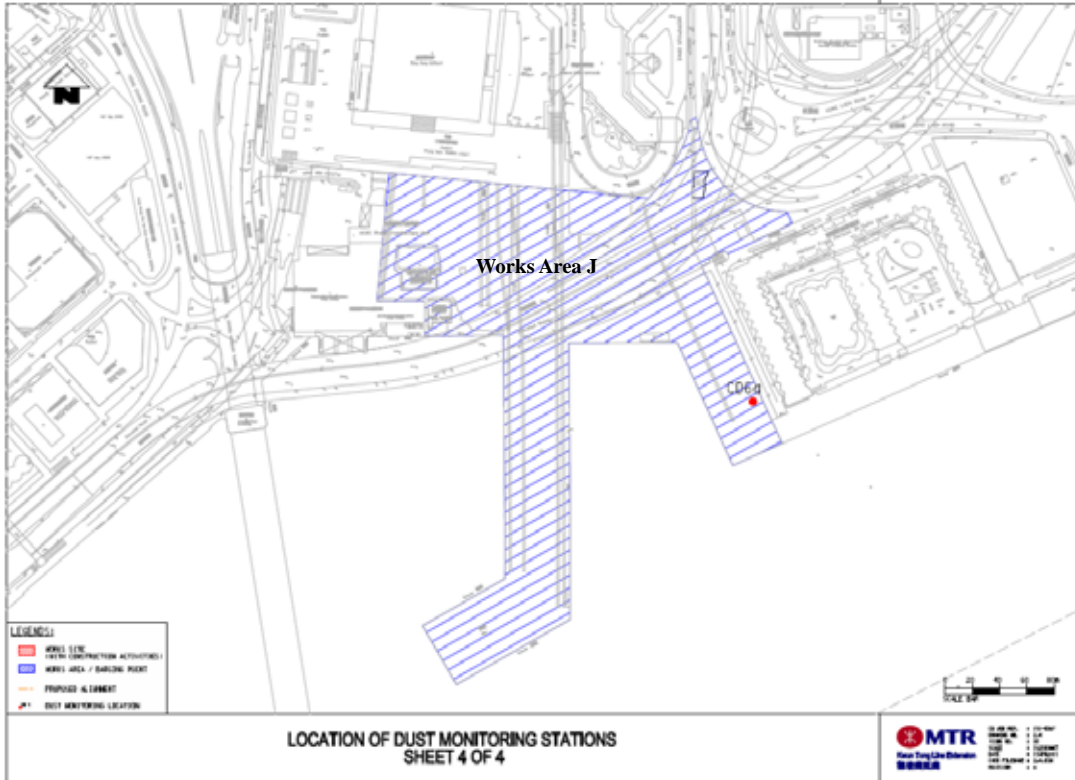

Figure 6. Location of Noise Monitoring Stations (CN1, CN2 and CN3a)

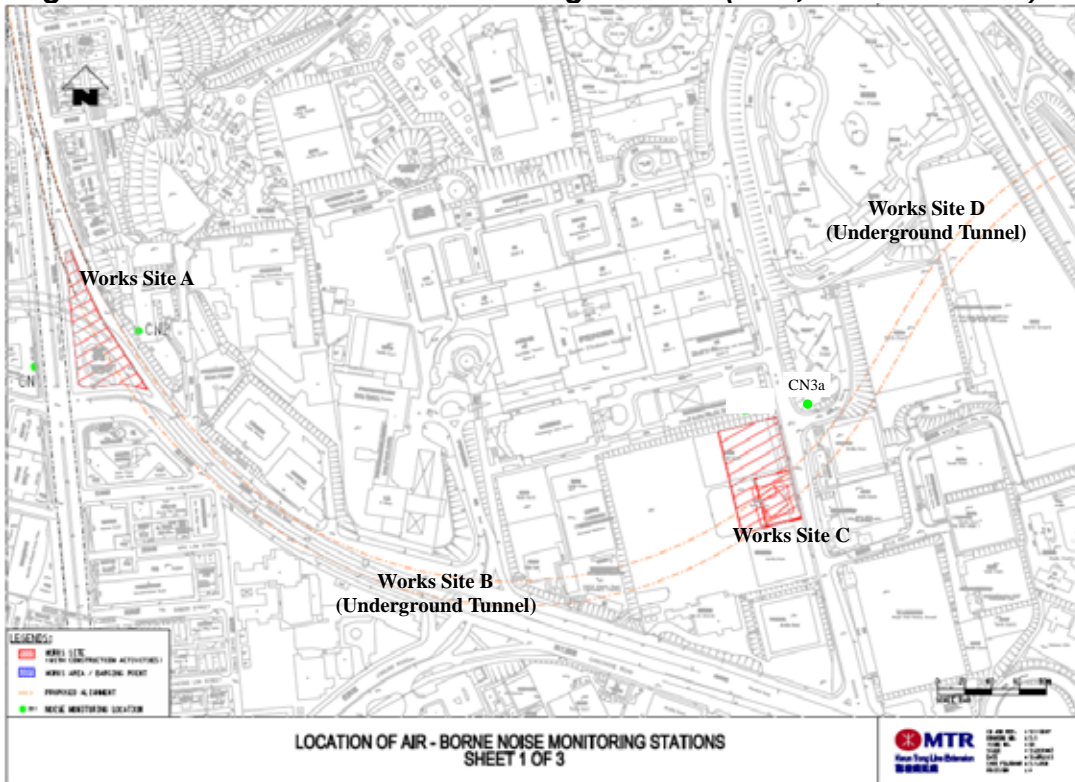

Figure 7. Location of Noise Monitoring Stations (CN4a and CN6)

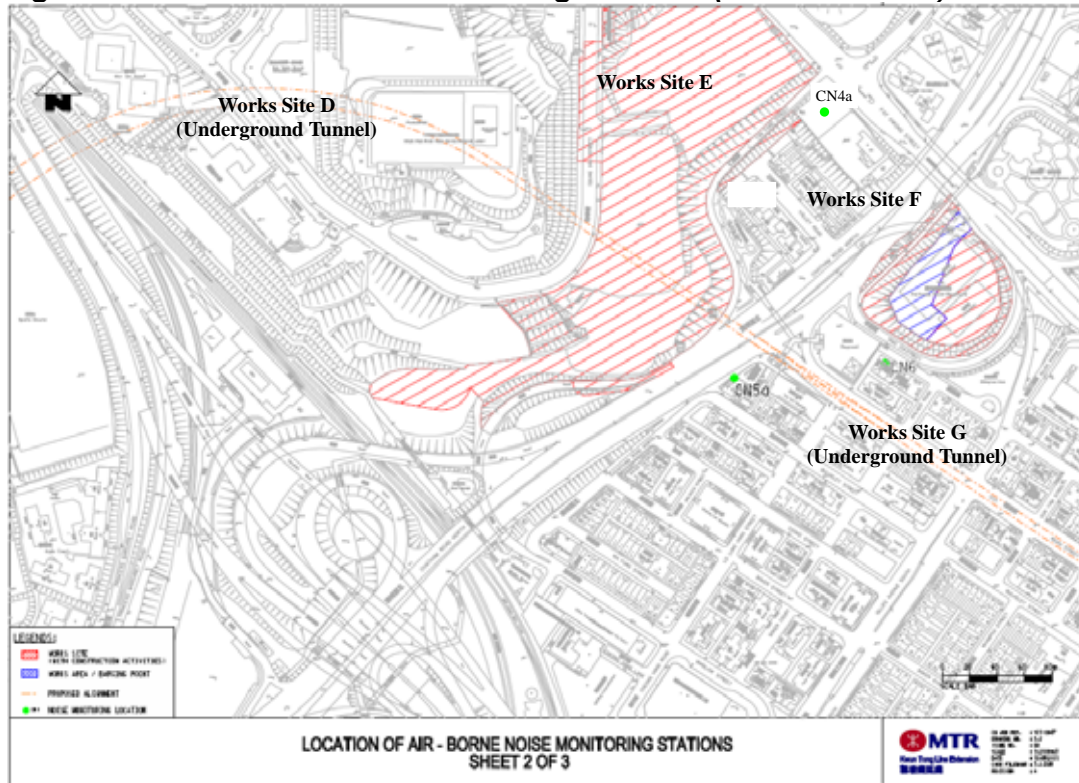

Figure 8. Location of Noise Monitoring Stations (CN7 to CN12)

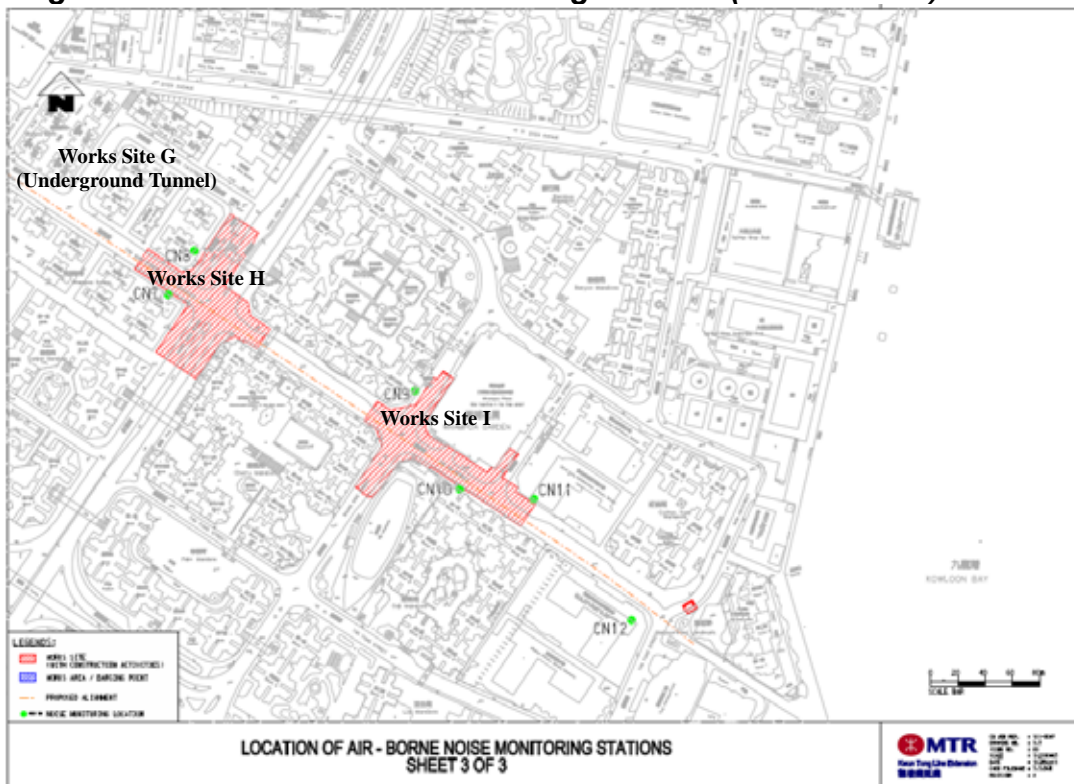

Figure 9. Location of Tseung Kwan O Area 137 Magazine Site

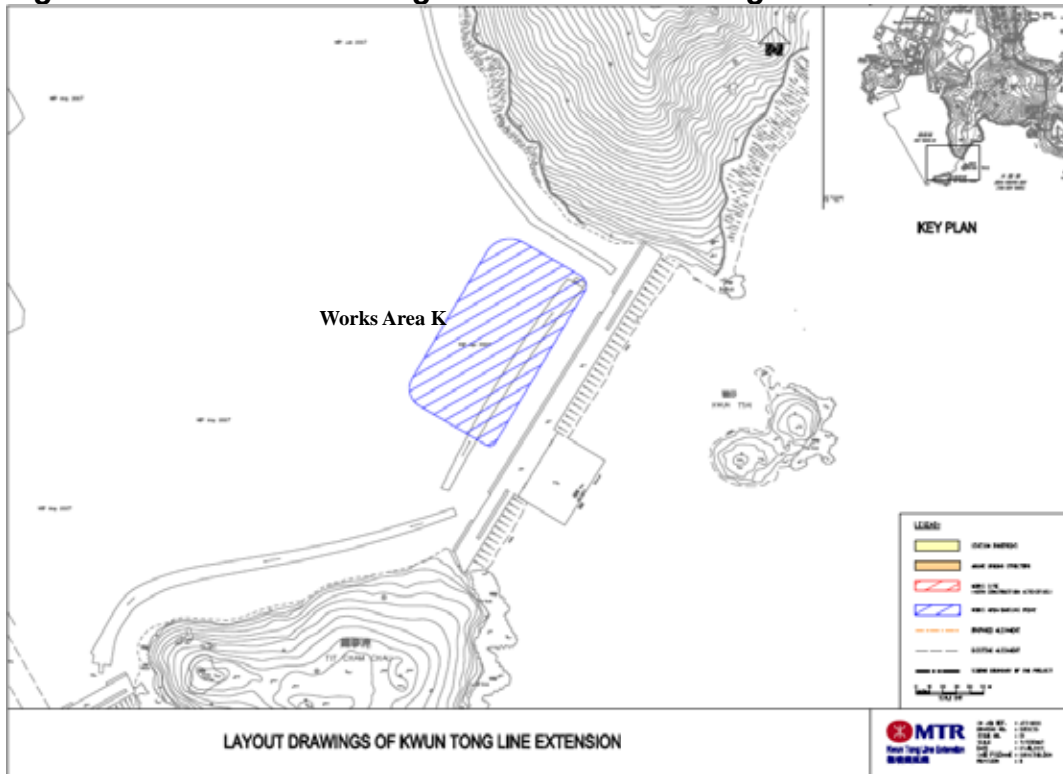
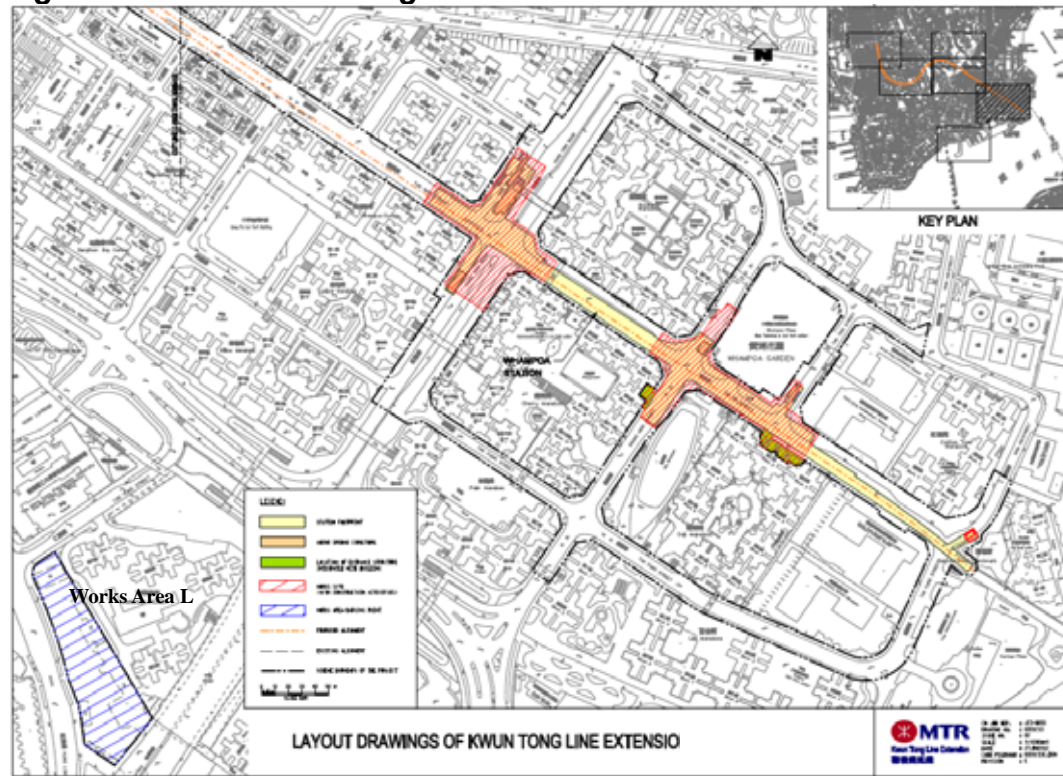

Figure 10. Location of Hung Lok Road Site Office



Appendix B

Environmental Quality Performance Limits

Action and Limit Levels for 24-hour TSP

Monitoring Station	Action Level ($\mu\text{g}/\text{m}^3$)	Limit Level ($\mu\text{g}/\text{m}^3$)
CD1a	171	260
CD2a	183	260
CD3a	192	260
CD4a	187	260
CD5	168	260
CD6a	182	260

Action and Limit Levels for 1-hour TSP for Complaint Handling

Monitoring Station	Action Level ($\mu\text{g}/\text{m}^3$)	Limit Level ($\mu\text{g}/\text{m}^3$)
CD1a	310	500
CD2a	301	500
CD3a	311	500
CD4a	303	500
CD5	309	500
CD6a	316	500

Action and Limit Levels for Construction Noise

Time Period	Action Level	Limit Level (dB(A)), Leq(30min)
0700-1900 hr on normal weekdays	When one documented complaint is received	75*

* Limit for school is 70 dB(A) and 65 dB(A) during school examination periods.

Appendix C

Event Action Plans

Table 4.4: Event and Action Plan for Construction Dust Monitoring

EVENT	ACTION			
	ET ⁽¹⁾	IEC ⁽¹⁾	ER ⁽¹⁾	Contractor
Action Level				
1. Exceedance for one sample	<ol style="list-style-type: none"> 1. Identify sources, investigate the causes of complaint and propose remedial measures. 2. Inform IEC and ER. 3. Repeat measurement to confirm finding; 4. Increase monitoring frequency. 	<ol style="list-style-type: none"> 1. Check monitoring data submitted by the ET. 2. Check the Contractor's working methods. 	<ol style="list-style-type: none"> 1. Notify the Contractor. 	<ol style="list-style-type: none"> 1. Rectify any unacceptable practices. 2. Amend working methods agreed with the ER as appropriate.
2. Exceedance for two or more consecutive samples	<ol style="list-style-type: none"> 1. Identify sources. 2. Inform the IEC and ER. 3. Advise the ER on the effectiveness of the proposed remedial measures; 4. Repeat measurements to confirm findings. 5. Increase monitoring frequency to daily. 6. Discuss with the IEC, ER and Contractor on remedial action required. 7. If exceedance continues, arrange meeting with the IEC, Contractor and ER. 8. If exceedance stops, cease additional monitoring. 	<ol style="list-style-type: none"> 1. Check monitoring data submitted by the ET. 2. Check the Contractor's working methods. 3. Discuss with the ET, ER and Contractor on possible remedial measures if required. 4. Advise the ER on the effectiveness of proposed remedial measures if required. 	<ol style="list-style-type: none"> 1. Notify the Contractor. 2. Ensure remedial measures properly implemented. 	<ol style="list-style-type: none"> 1. Submit proposals for remedial action to the ER within 3 working days of notification. 2. Implement the agreed proposals. 3. Amend proposal as appropriate.

EVENT	ACTION			
	ET ⁽¹⁾	IEC ⁽¹⁾	ER ⁽¹⁾	Contractor
Limit Level				
1. Exceedance for one sample	<ol style="list-style-type: none"> 1. Identify sources, investigate causes of exceedance and proposed remedial measures. 2. Inform the IEC, ER, and Contractor. 3. Repeat measurement to confirm finding. 4. Increase monitoring frequency to daily. 5. Assess effectiveness of the Contractor's remedial action and keep the IEC and ER informed of the results. 	<ol style="list-style-type: none"> 1. Check monitoring data submitted by the ET. 2. Check the Contractor's working methods. 3. Discuss with the ET, ER and Contractor on possible remedial measures. 4. Advise the ER and ET on the effectiveness of the proposed remedial measures. 5. Supervise the implementation of remedial measures. 	<ol style="list-style-type: none"> 1. Confirm receipt of the notification of exceedance in writing. 2. Notify the Contractor. 3. Ensure remedial measures are properly implemented. 	<ol style="list-style-type: none"> 1. Take immediate action to avoid further exceedance. 2. Submit proposals for remedial action to the ER and copy to the ET and IEC within 3 working days of notification. 3. Implement the agreed proposals. 4. Amend proposal as appropriate.

Table 5.3: Event and Action Plan for Construction Noise Monitoring

EVENT	ACTION			
	ET ⁽¹⁾	IEC ⁽¹⁾	ER ⁽¹⁾	Contractor
Action Level	<ol style="list-style-type: none"> 1. Notify the IEC, ER and Contractor. 2. Carry out investigation. 3. Report the results of investigation to the IEC and Contractor. 4. Discuss jointly with the ER and Contractor and formulate remedial measures. 5. Increase the monitoring frequency to check the mitigation effectiveness. 	<ol style="list-style-type: none"> 1. Review the monitoring data submitted by the ET. 2. Review the construction methods and proposed remedial measures by the Contractor, and advise the ET and ER if the proposed remedial measures would be sufficient. 	<ol style="list-style-type: none"> 1. Notify the Contractor. 2. Require the Contractor to propose remedial measures for implementation if required. 	<ol style="list-style-type: none"> 1. Submit noise mitigation proposals to the ER and copy to the IEC and ET. 2. Implement noise mitigation proposals.
Limit Level	<ol style="list-style-type: none"> 1. Notify the IEC, ER and Contractor. 2. Identify sources. 3. Repeat measurements to confirm findings. 4. Carry out analysis of the Contractor's working procedures with the ER and Contractor to determine possible mitigations to be implemented. 5. Record the causes and action taken for the exceedances. 6. Increase the monitoring frequency. 7. Assess the effectiveness of the Contractor's remedial action with the ER and keep the IEC informed of the results. 8. If exceedance stops, cease additional monitoring. 	<ol style="list-style-type: none"> 1. Discuss amongst the ER, ET and Contractor on the potential remedial action. 2. Review the Contractor's remedial action whenever necessary to assure their effectiveness and advise the ER accordingly. 3. Supervise the implementation of remedial measures. 	<ol style="list-style-type: none"> 1. Confirm receipt of notification of exceedance in writing. 2. Notify the Contractor. 3. Require the Contractor to propose remedial measures for the analysed noise problems. 4. Ensure remedial measures are properly implemented. 5. If exceedance continues, consider what portion of work is responsible and instruct the Contractor to stop that portion of works until the exceedance is abated. 	<ol style="list-style-type: none"> 1. Take immediate action to avoid further exceedance. 2. Submit proposals for remedial action to the ER and copy to the ET and IEC within 3 working days of notification. 3. Implement the agreed proposals. 4. Resubmit proposals if problems still not under control. 5. Stop the relevant portion of works as determined by the ER until the exceedance is abated.

Note (1): ET – Environmental Team, IEC – Independent Environmental Checker, ER – Engineer's Representative

Table 3.2: Event / Action Plan for Construction/Operational Phase

Action Level	ET	IEC	ER	Contractor
Non-conformity on one occasion	<ol style="list-style-type: none"> 1. Identify Source 2. Inform the IEC and the ER 3. Discuss remedial actions with the IEC, the ER and the Contractor 4. Monitor remedial actions until rectification has been completed 	<ol style="list-style-type: none"> 1. Check report 2. Check the Contractor's working method 3. Discuss with the ET and the Contractor on possible remedial measures 4. Advise the ER on effectiveness of proposed remedial measures. 5. Check implementation of remedial measures. 	<ol style="list-style-type: none"> 1. Notify Contractor 2. Ensure remedial measures are properly implemented 	<ol style="list-style-type: none"> 1. Amend working methods 2. Rectify damage and undertake any necessary replacement
Repeated Non-conformity	<ol style="list-style-type: none"> 1. Identify Source 2. Inform the IEC and the ER 3. Increase monitoring frequency 4. Discuss remedial actions with the IEC, the ER and the Contractor 5. Monitor remedial actions until rectification has been completed 6. If exceedance stops, cease additional monitoring 	<ol style="list-style-type: none"> 1. Check monitoring report 2. Check the Contractor's working method 3. Discuss with the ET and the Contractor on possible remedial measures 4. Advise the ER on effectiveness of proposed remedial measures 5. Supervise implementation of remedial measures. 	<ol style="list-style-type: none"> 1. Notify the Contractor 2. Ensure remedial measures are properly implemented 	<ol style="list-style-type: none"> 1. Amend working methods 2. Rectify damage and undertake any necessary replacement

Note:

ET – Environmental Team

IEC – Independent Environmental Checker

ER – Engineer's Representative

Appendix D

Implementation of Environmental Mitigation Measures

Appendix 1.1 Implementation Schedule for Environmental Mitigation Measures

EIA Reference	EM&A Manual Reference	Environmental Protection Measures	Objectives of Measures and Main Concern to Address	Location	Implementation Agent	Relevant Standard or Requirement	Implementation Stages			Maintenance Agent	Implementation status
							D	C	O		
Miscellaneous											
3.4.2.1		<u>WSD Fresh Water Service Reservoir</u> Undertake an independent study of the effects of the drill and blast tunnelling on the reservoir to the satisfaction of WSD.	Ensure stability of the reservoir during construction	WSD Fresh Water Service Reservoir	MTR Corporation/ Main Contractor	-		✓		n/a	To be implemented as per construction programme
Landscape and Visual											
5.12.1.2		<u>Reuse of Existing Topsoil</u> Existing topsoil shall be re-used for new planting areas within the project. The Contractor's construction plan shall consider using the soil removed for backfilling. Suitable storage ground, gathering ground and mixing ground shall be set up if necessary.	Conservation of valuable natural landscape resources	Gascoigne Road Rest Garden, Hill slopes above Chatham Road North, Roadside planters at Hung Hom Road	MTR Corporation/ Main Contractor	EIA recommendation		✓		MTR Corporation / LandsD, LCSD / HyD	Implemented
5.12.1.2		<u>Tree Transplantation</u> Transplantation is proposed for a number of trees which are generally able to provide high amenity value and are likely to survive the transplantation process.	Conservation of valuable natural landscape resources	Gascoigne Road Rest Garden, HOM Station, Yan Fung Street Rest Garden Slopes surrounding Fat Kwong Street Playground, WHA Station	MTR Corporation/ Main Contractor/ Detailed Design Consultant	All transplantation will be carried out in accordance with ETWB TCW No. 3/2006.	✓	✓		MTR Corporation / LandsD / HyD / LCSD / AFCD	Implemented
5.12.1.2		<u>Erection of Decorative Hoardings</u> Temporary decorative screen hoardings shall be designed and erected to be compatible with the existing urban context, either brightly and imaginatively or with visually unobtrusive design and colours where more appropriate. All works sites and works areas shall be surrounded by such hoardings, which shall be removed at project completion.	Visual screening of works site during construction	All works sites and Temporary Works Areas	MTR Corporation/ Main Contractor/ Detailed Design Consultant	EIA recommendation	✓	✓		Contractor	Implemented
5.12.1.2		<u>Control of night-time lighting glare</u> All security floodlights for construction sites and temporary works areas shall be equipped with adjustable shield, frosted diffusers and reflective covers, and be carefully controlled	Restricting light pollution to nearby receivers	All works sites and Temporary Works Areas	Main Contractor	EIA recommendation		✓		Contractor	To be implemented as per construction programme

EIA Reference	EM&A Manual Reference	Environmental Protection Measures	Objectives of Measures and Main Concern to Address	Location	Implementation Agent	Relevant Standard or Requirement	Implementation Stages			Maintenance Agent	Implementation status
							D	C	O		
		to minimize light pollution and night-time glare to nearby receivers.									
5.12.1.2		<p><u>Re-provision of Public Open Spaces</u> Every effort should be made to minimise use of public open spaces, however if affected by the Project they shall be re-provisioned to an equal or improved standard at completion of the project. Sensitive design and reinstatement of the affected Public Open Spaces (Gascoigne Road Rest Garden, Yan Fung Street Rest Garden, Fat Kwong Street Playground) shall be made, incorporating replacement facilities to those currently provided and using materials of quality suitable for long term use and acceptable to the relevant government departments including LCSD and PlanD, who shall be consulted on the design of the reinstated public open spaces at an early stage of the design process.</p>	Replacement of loss of resources	Gascoigne Road Rest Garden, Yan Fung Street Rest Garden, Fat Kwong Street Playground,	MTR Corporation / Main Contractor/ Detailed Design Consultant	EIA recommendation	✓	✓	✓	LCSD	To be implemented as per construction programme
5.12.1.2		<p><u>Compensatory Tree Planting</u> Suitable land pockets within the project area will be used for the implementation of compensatory mitigation to offset the net loss of key landscape resources and improve visual amenity. A compensatory tree planting proposal including locations of tree compensation will be submitted separately to seek relevant government department's approval, in accordance with ETWB TCW No. 3/2006.</p>	Replacement of loss of resources and Enhancement of visual amenity	Gascoigne Road Rest Garden, Yan Fung Street Rest Garden, Fat Kwong Street Playground, WAB, HOM Station WHA Station	MTR Corporation / Main Contractor/ Detailed Design Consultant	ETWB TCW No. 3/2006. WBTC 7/2002	✓	✓	✓	MTR Corporation / LandsD/ HyD/ LCSD/ AFCD	To be implemented as per construction programme
5.12.1.2		<p><u>Horizontal and Slope Greening</u> Shotcreting of cut rock slopes shall be avoided and greening applications employed throughout the project. At HOM Station the backfill slopes shall be hydroseeded and native seedling trees planted. The station roof shall be temporarily greened should there be no further on-site development within 1 year of completion of</p>	Mitigation of loss of resources and Enhancement of visual amenity	Gascoigne Road Rest Garden, Yan Fung Street Rest Garden, Fat Kwong Street Playground, WAB, HOM Station	MTR Corporation/ Main Contractor/ Detailed Design Consultant	WBTC 25/93 WBTC 17/2000	✓	✓	✓	MTR Corporation / LandsD	To be implemented as per construction programme

EIA Reference	EM&A Manual Reference	Environmental Protection Measures	Objectives of Measures and Main Concern to Address	Location	Implementation Agent	Relevant Standard or Requirement	Implementation Stages			Maintenance Agent	Implementation status
							D	C	O		
		<p>KTE, until permanent measures are undertaken under the proposed property development stage.</p> <p>Parapets at WAB and HOM Station shall be provided with internal permanent planter boxes.</p> <p>The roof at WAB shall be greened to improve visual amelioration from surrounding high level viewers</p> <p>Station entrances at HOM and WHA shall utilise shrub planting areas to provide localised greening</p>		WHA Station							
5.12.1.2		<p><u>Planting</u></p> <p>Vertical greening / climbers shall be applied to all above ground structures against exposed walls where appropriate. Further such localised planting systems shall be instigated subject to technical operational and maintenance constraints.</p>	Mitigation of loss of resources and Enhancement of visual amenity	WAB, HOM Station	MTR Corporation/ Main Contractor/ Detailed Design Consultant	EIA recommendation	✓	✓	✓	MTR Corporation	To be implemented as per construction programme
5.12.1.2		<p><u>Architectural Design Aesthetics for the WAB at Club de Recreio</u></p> <p>The emergency access and ventilation building shall be designed in a way so as to ensure the form, material and surface detailing of this structure can fit sympathetically into the local context. The form shall consider the Cultural Heritage of the Club de Recreio site as well as other proximate buildings. The structure shall incorporate vertical greening / climbers.</p>	Enhancement of visual amenity	WAB	MTR Corporation/ Main Contractor/ Detailed Design Consultant	EIA recommendation	✓	✓	✓	MTR Corporation	To be implemented as per construction programme
5.12.1.2		<p><u>Architectural Design Aesthetics for Above-Ground Structures at HOM Station</u></p> <p>All station entrances, vent shafts, chillers and other above-ground structures shall be designed in accordance with the standardised MTR Corporation architectural theme for the KTE and other current rail projects. However specific attention shall be undertaken to ensure the form, material and surface detailing of these structures is considered to</p>	Enhancement of visual amenity	HOM Station	MTR Corporation/ Main Contractor/ Detailed Design Consultant	EIA recommendation	✓	✓	✓	MTR Corporation	To be implemented as per construction programme

EIA Reference	EM&A Manual Reference	Environmental Protection Measures	Objectives of Measures and Main Concern to Address	Location	Implementation Agent	Relevant Standard or Requirement	Implementation Stages			Maintenance Agent	Implementation status
							D	C	O		
		fit into the local context in terms of the architectural character of the site.									
5.12.1.2		<p><u>Architectural Design Aesthetics for Above-Ground Structures at WHA Station</u></p> <p>These shall be designed in accordance with the standardised MTR Corporation architectural theme for the KTE and other current rail projects. However specific attention shall be undertaken to ensure the form, material and surface detailing of these structures is considered to fit into the local context in terms of the architectural character of the site.</p>	Enhancement of visual amenity	WHA Station	MTR Corporation/ Main Contractor/ Detailed Design Consultant	EIA recommendation	✓	✓	✓	MTR Corporation	To be implemented as per construction programme
Air Quality											
S.6.7.1.7 & S.6.9.2.3		<p>Cut-and-Cover areas in the vicinity of adits and shafts (if applicable):-</p> <ul style="list-style-type: none"> ▪ Heavy construction activities and wind erosion at the cut-and-cover areas, active areas for heavy construction activities: <ul style="list-style-type: none"> - Watering every hour at exposed soil. ▪ Trucks for transportation of materials: <ul style="list-style-type: none"> - Wheel washing facilities should be provided at all site exits. Vehicles should be washed before leaving works sites. Spoil on trucks should be well covered before leaving works sites to minimise the generation of dusty materials. - Haul roads within works sites should be paved and water spraying would be provided to keep the wet condition. 	To minimise dust impacts	All relevant works sites	MTR Corporation/ Main Contractor/ Detailed Design Consultant	Air Pollution Control Ordinance	✓	✓			Implemented
S.6.7.1.7 & S.6.9.2.3		<p>Barging point at Hung Hom Finger Pier:</p> <ul style="list-style-type: none"> ▪ For haul roads within the area of barging point for transportation of spoil, all road surfaces should be paved and hourly water spraying should be provided to keep the wet condition as far as practical. ▪ The spoil unloading process should be 	To minimise dust impacts	Barging Point at Hung Hom Finger Pier	MTR Corporation/ Main Contractor/ Detailed Design Consultant	Air Pollution Control Ordinance	✓	✓			Implemented

EIA Reference	EM&A Manual Reference	Environmental Protection Measures	Objectives of Measures and Main Concern to Address	Location	Implementation Agent	Relevant Standard or Requirement	Implementation Stages			Maintenance Agent	Implementation status
							D	C	O		
		undertaken within an enclosed tipping hall. Water spraying and 3-sided screen with top should be provided at the discharge point for dust suppression. <ul style="list-style-type: none"> Vehicle wheel washing facilities should be provided at the exits of the barging point. 									
S.6.7.1.5 & S. 6.7.1.8		Rock crushing equipment at HOM Station and barging point at Hung Hom Finger Pier if operated during construction: <ul style="list-style-type: none"> A dust enclosure with fabric baghouse/cartridge filter type dust extraction and collection system or equivalent system with 99% or more dust removal efficiency for the rock crushing equipment, haul road and unloading location; and Watering of paved roads within the area of the rock crushing facility as good site practice. 	To minimise dust impacts	Rock crushing equipment at HOM Station and Barging Point at Hung Hom Finger Pier	MTR Corporation/ Main Contractor/Detailled Design Consultant	Air Pollution Control Ordinance	✓	✓			To be implemented as per construction programme
S.6.7.1.5 & S.6.9.2.2		Tarpaulin covers would be provided on wire mesh covered steel cages to prevent dust emission during open blasting at HOM Station;	To minimise dust impacts	Open blasting area at HOM Station	MTR Corporation/ Main Contractor/Detailled Design Consultant	EIA recommendation	✓	✓			To be implemented as per construction programme
S.6.9.2.4		Dust suppression measures stipulated in the Air Pollution Control (Construction Dust) Regulation and good site practices: <ul style="list-style-type: none"> Use of regular watering, to reduce dust emissions from exposed site surfaces and unpaved roads, particularly during dry weather. Use of frequent watering for particularly dusty construction areas and areas close to ASRs. Side enclosure and covering of any aggregate or dusty material storage piles to reduce emissions. Where this is not 	To minimise dust impacts	All works sites	MTR Corporation/Main Contractor /Detailed Design Consultant	Air Pollution Control Ordinance	✓	✓			Implemented

EIA Reference	EM&A Manual Reference	Environmental Protection Measures	Objectives of Measures and Main Concern to Address	Location	Implementation Agent	Relevant Standard or Requirement	Implementation Stages			Maintenance Agent	Implementation status
							D	C	O		
		practicable owing to frequent usage, watering should be applied to aggregate fines. <ul style="list-style-type: none"> ▪ Open temporary stockpiles should be avoided or covered. Prevent placing dusty material storage piles near ASRs. ▪ Tarpaulin covering of all dusty vehicle loads transported to, from and between site locations. ▪ Establishment and use of vehicle wheel and body washing facilities at the exit points of the site. ▪ Imposition of speed controls for vehicles on unpaved site roads. 8km per hour is the recommended limit. ▪ Routing of vehicles and positioning of construction plant should be at the maximum possible distance from ASRs. ▪ Every stock of more than 20 bags of cement or dry pulverised fuel ash (PFA) should be covered entirely by impervious sheeting or placed in an area sheltered on the top and the 3 sides. ▪ Loading, unloading, transfer, handling or storage of large amount of cement or dry PFA should be carried out in a totally enclosed system or facility, and any vent or exhaust should be fitted with an effective fabric filter or equivalent air pollution control system. ▪ Covering or enclosing any conveyor belt systems will generally be fully enclosed, depending on the design, materials chosen, and dimension of the conveyor system. 									
Air-borne Noise											
S.7.9.2.6		The following good site practices should be implemented: <ul style="list-style-type: none"> ▪ Only well-maintained plant should be operated on-site and plants should be serviced regularly during the construction period; ▪ Mobile plant, if any, should be sited as 	To minimise air-borne noise impacts	All works sites	MTR Corporation/ Main Contractor	Noise Control Ordinance		✓			Implemented

EIA Reference	EM&A Manual Reference	Environmental Protection Measures	Objectives of Measures and Main Concern to Address	Location	Implementation Agent	Relevant Standard or Requirement	Implementation Stages			Maintenance Agent	Implementation status
							D	C	O		
		far from NSRs as possible; <ul style="list-style-type: none"> ▪ Plant known to emit noise strongly in one direction should, wherever possible, be properly orientated so that the noise is directed away from the nearby NSRs; ▪ Use of site hoarding as a noise barrier to screen noise at low level NSRs; ▪ Machines and plant that may be in intermittent use should be shut down between works periods or should be throttled down to a minimum; and ▪ Any material stockpiles and other structures should be effectively utilised, wherever practicable, to screen the noise from on-site construction activities. 									
S.7.9.2.1		The following quiet PME should be used: <ul style="list-style-type: none"> ▪ Air compressor ▪ Asphalt Paver ▪ Breaker ▪ Bulldozer ▪ Concrete lorry mixer ▪ Concrete Pump / Grout Pump ▪ Crane ▪ Cutter, circular, steel (electric) ▪ Dump Truck ▪ Backhoe ▪ Generator ▪ Vibrating Poker, hand-held (electric) ▪ Rock Drill ▪ Roller, vibratory ▪ Scraper ▪ Water pump (electric) 	To minimise air-borne noise impacts	All relevant works sites	MTR Corporation/ Main Contractor	Noise Control Ordinance		✓			Implemented

EIA Reference	EM&A Manual Reference	Environmental Protection Measures	Objectives of Measures and Main Concern to Address	Location	Implementation Agent	Relevant Standard or Requirement	Implementation Stages			Maintenance Agent	Implementation status
							D	C	O		
S.7.9.2.4		Movable or fixed noise barrier should be used for the following PME where practicable: <ul style="list-style-type: none"> ▪ Wheeled Excavator/Loader ▪ Crane ▪ Hydraulic Breaker ▪ Scraper ▪ Breaker, hand-held ▪ Compactor, vibratory ▪ Drill, percussive, hand-held (electric) ▪ Concrete pump ▪ Circular Saw, bench mounted ▪ Truck ▪ Bar bender and cutter (electric) ▪ Conveyor belt ▪ Generator, Super Silenced ▪ Grout Pump ▪ Saw, wire ▪ Water Pump, Submersible (Electric) ▪ Hydraulic Jack with Pump 	To minimise air-borne noise impacts	All relevant works sites	MTR Corporation/ Main Contractor	Noise Control Ordinance		✓			Implemented
S.7.9.2.4		Acoustic fabric should be used for the following PME where practicable: <ul style="list-style-type: none"> ▪ Compressor and Pneumatic Drilling Rig ▪ Piling, vibrating hammer ▪ Rock Drill ▪ Silent Piling System 	To minimise air-borne noise impacts	All relevant works sites	MTR Corporation/ Main Contractor	Noise Control Ordinance		✓			Implemented
S.7.9.2.4		Noise enclosure/acoustic shed should be used for the following PME where practicable and will generally be fully enclosed depending on the design, materials chosen, and dimension of the PME: <ul style="list-style-type: none"> ▪ Air Compressor ▪ Rock Crushing Equipment 	To minimise air-borne noise impacts	All relevant works sites	MTR Corporation/ Main Contractor	Noise Control Ordinance		✓			Implemented
S.7.9.2.4		Silencer should be used for the ventilation fans.	To minimise air-borne noise impacts	All relevant works sites	MTR Corporation/ Main Contractor	Noise Control Ordinance		✓			Implemented
S.7.9.2.6		Use of temporary hoardings along the works boundary.	To minimise air-borne noise impacts	All relevant works sites	MTR Corporation/ Main Contractor	Noise Control Ordinance		✓			Implemented

EIA Reference	EM&A Manual Reference	Environmental Protection Measures	Objectives of Measures and Main Concern to Address	Location	Implementation Agent	Relevant Standard or Requirement	Implementation Stages			Maintenance Agent	Implementation status
							D	C	O		
S.7.9.2.2		Noise enclosures should be installed for the muckout points in WS1 (Gascoigne Road Rest Garden), WS7a1 (WAB at Club de Recreio) and WS26a (Fat Kwong Street Playground)	To comply with the criteria of Noise Control Ordinance.	All muckout points at WS1, WS7a1 and WS26a	MTR Corporation/ Main Contractor	Noise Control Ordinance		✓			Implemented
S.7.9.2.3		Noise enclosures should be installed for all rock crushing equipment.	To comply with the criteria of Noise Control Ordinance.	All rock crushing equipment	MTR Corporation/ Main Contractor	Noise Control Ordinance		✓			To be implemented as per construction programme
S.7.10.1.2		The maximum permissible sound power levels (max SWLs) for the fixed plant should be complied with during the selection of equipment and mitigation measures.	To comply with the criteria of Noise Control Ordinance.	All relevant location of fixed plant	MTR Corporation/ Detailed Design Consultant	Noise Control Ordinance	✓		✓		To be implemented as per construction programme
S.7.10.2.1		The detailed design for all fixed plant should incorporate the following good practice where practicable: <ul style="list-style-type: none"> ▪ Louvers should be orientated away from adjacent NSRs whenever practicable; ▪ Adequate direct noise mitigation measures including silencers, acoustic louvers or acoustic enclosures should be adopted where necessary; and ▪ Quieter plant should be chosen as far as practical. 	To comply with the criteria of Noise Control Ordinance.	At outlets of fixed plant including ventilation building, ventilation shafts, plant room for chiller plant and cooling towers, etc	MTR Corporation/ Detailed Design Consultant	Noise Control Ordinance	✓		✓		To be implemented as per construction programme
Ground-borne Noise											
S.8.7.1.2		MTR will further review the proposed mitigation measures for operational ground-borne noise during the construction stage after the tunnel boring.	To comply with the criteria of Noise Control Ordinance.	At suitable location	MTR Corporation/ Main Contractor	-	✓				To be implemented as per construction programme
S.8.7.1.3		Commissioning test is recommended to ensure compliance of the operational ground-borne noise levels	To comply with the criteria of Noise Control Ordinance.	Designated locations	MTR Corporation/ Main Contractor	Noise Control Ordinance	✓	✓	✓		To be implemented as per construction programme
Water Quality											
S.9.7.6		Construction site run-off and general construction activities: <ul style="list-style-type: none"> ▪ The mitigation measures as outlined in the ProPECC PN 1/94 Construction Site Drainage should be adopted where 	To control water quality impact from construction site runoff and general construction activities	All works sites	MTR Corporation/ Main Contractor	EIAO-TM, Water Pollution Control Ordinance, TM-DSS		✓			Implemented

EIA Reference	EM&A Manual Reference	Environmental Protection Measures	Objectives of Measures and Main Concern to Address	Location	Implementation Agent	Relevant Standard or Requirement	Implementation Stages			Maintenance Agent	Implementation status
							D	C	O		
		applicable.									
S.9.7.6		In case seepage of uncontaminated groundwater occurs, groundwater should be pumped out from the works areas and discharged into the storm system via silt removal facilities. Uncontaminated groundwater from dewatering process should also be discharged into the storm system via silt traps.	To control water quality impact from groundwater	All works sites	MTR Corporation/ Main Contractor	EIAO-TM, Water Pollution Control Ordinance		✓			To be implemented as per construction programme
S.9.7.6		At the barging point, mitigation measures for control of water quality impact from surface run-off should be applied and the following good site practices should also be adopted: <ul style="list-style-type: none"> ▪ All vessels should be sized so that adequate clearance is maintained between vessels and the seabed in all tide conditions, to ensure that undue turbidity is not generated by turbulence from vessel movement or propeller wash. ▪ All hopper barges should be fitted with tight fitting seals to their bottom openings to prevent leakage of material. ▪ Construction activities should not cause foam, oil, grease, scum, litter or other objectionable matter to be present on the water within the site. ▪ Loading of barges and hoppers should be controlled to prevent splashing of material into the surrounding water. Barges or hoppers should not be filled to a level that will cause the overflow of materials or polluted water during loading or transportation. 	To control water quality impact from barging point	Barging point	MTR Corporation/ Main Contractor	EIAO-TM, Water Pollution Control Ordinance		✓		To be implemented as per construction programme	
S.9.7.6		For effluent discharge, there is a need to apply to EPD for a discharge licence for discharge of effluent from the construction site under the WPCO. The discharge quality should meet the requirements specified in the discharge licence. Minimum distances of 100m should be maintained between the discharge points of construction site effluent and the existing seawater intakes. If	To control water quality impact from effluent discharge from construction site	All works sites	MTR Corporation/ Main Contractor	EIAO-TM, Water Pollution Control Ordinance		✓			Implemented

EIA Reference	EM&A Manual Reference	Environmental Protection Measures	Objectives of Measures and Main Concern to Address	Location	Implementation Agent	Relevant Standard or Requirement	Implementation Stages			Maintenance Agent	Implementation status
							D	C	O		
		monitoring of the treated effluent quality from the works areas is required during the construction phase of the Project, the monitoring should be carried out in accordance with the WPCO license which is under the ambit of Regional Office of the EPD.									
S.9.7.6		To prevent the accidental spillage of chemicals, the Contractor should register as a chemical waste producer if chemical wastes would be produced from the construction activities. The Waste Disposal Ordinance (Cap 354) and its subsidiary regulations in particular the Waste Disposal (Chemical Waste) (General) Regulation should be observed and complied with for control of chemical wastes.	To control water quality impact from accidental chemical spillage	All works sites	MTR Corporation/ Main Contractor	EIAO-TM, Water Pollution Control Ordinance, Waste Disposal Ordinance		✓			Implemented
S.9.7.6		Any service shop and maintenance facilities should be located on hard standings within a bunded area, and sumps and oil interceptors should be provided. Maintenance of vehicles and equipment involving activities with potential for leakage and spillage should only be undertaken within the areas appropriately equipped to control these discharges.	To control water quality impact from accidental chemical spillage	All works sites	MTR Corporation/ Main Contractor	EIAO-TM, Water Pollution Control Ordinance, Waste Disposal Ordinance		✓			Implemented
S.9.7.6		Disposal of chemical wastes should be carried out in compliance with the Waste Disposal Ordinance. The Code of Practice on the Packaging, Labelling and Storage of Chemical Wastes published under the Waste Disposal Ordinance details the requirements to deal with chemical wastes. General requirements are given as follows: <ul style="list-style-type: none"> ▪ Suitable containers should be used to hold the chemical wastes to avoid leakage or spillage during storage, handling and transport. ▪ Chemical waste containers should be suitably labelled, to notify and warn the personnel who are handling the wastes, to avoid accidents. ▪ Storage area should be selected at a safe 	To control water quality impact from accidental chemical spillage	All works sites	MTR Corporation/ Main Contractor	EIAO-TM, Water Pollution Control Ordinance, Waste Disposal Ordinance		✓		Implemented	

EIA Reference	EM&A Manual Reference	Environmental Protection Measures	Objectives of Measures and Main Concern to Address	Location	Implementation Agent	Relevant Standard or Requirement	Implementation Stages			Maintenance Agent	Implementation status
							D	C	O		
		location on site and adequate space should be allocated to the storage area.									
S.9.7.6		<p>Regarding the hydrogeological impacts in the construction of cut-and-cover tunnels and associated excavations for the WAB / ventilation building, the following measures should be in place in order to mitigate any drawdown effects to the groundwater table during the operation of the temporary dewatering works:</p> <ul style="list-style-type: none"> ▪ Toe grouting should be applied beneath the toe level of the temporary/permanent cofferdam walls as necessary to lengthen the effective flow path of groundwater from outside and thus control the amount of water inflow to the excavation. ▪ Recharge wells should be installed as necessary outside the excavation areas. Water pumped from the excavation areas should be recharged back into the ground. 	To control groundwater hydrogeological impact and groundwater drawdown	All works sites	MTR Corporation/ Main Contractor	EIAO-TM, Water Pollution Control Ordinance		✓			To be implemented as per construction programme
S.9.8.6		<p>Measures for the tunnel run-off and drainage include:</p> <ul style="list-style-type: none"> ▪ Track drainage channels discharge should pass through oil/grit interceptors/chambers to remove oil, grease and sediment before being pumped to the foul sewer/holding tank for further disposal. ▪ The silt traps and oil interceptors should be cleaned and maintained regularly. ▪ Oily contents of the oil interceptors should be transferred to an appropriate disposal facility, or to be collected for reuse, if possible. 	To control runoff from rail track	Tunnels and rail tracks	MTR Corporation/ Detailed Design Consultant	Water Pollution Control Ordinance	✓		✓		To be implemented as per construction programme
S.9.8.6		<p>Measures for the control of sewage effluents include:</p> <ul style="list-style-type: none"> ▪ Connection of domestic sewage generated from the KTE project should be diverted to the foul sewer wherever possible. If public sewer system is not 	To control water quality impact from sewage effluent discharge from the ventilation building and Stations	Ventilation building and Stations	MTR Corporation/ Detailed Design Consultant	EIAO-TM, Water Pollution Control Ordinance, TM-DSS, ProPECC PN	✓		✓		To be implemented as per construction programme

EIA Reference	EM&A Manual Reference	Environmental Protection Measures	Objectives of Measures and Main Concern to Address	Location	Implementation Agent	Relevant Standard or Requirement	Implementation Stages			Maintenance Agent	Implementation status
							D	C	O		
		available, sewage tankering away services or on-site sewage treatment facilities should be provided to prevent direct discharge of sewage to the nearby storm system and all the discharge should comply with the requirements stipulated in the TM-DSS. <ul style="list-style-type: none"> ▪ For handling, treatment and disposal of other operation stage effluent, the practices outlined in ProPECC PN 5/93 should be adopted where applicable. 				5/93					
Waste Management Implications											
S.10.5.6.1		Recommendations for good site practices: <ul style="list-style-type: none"> ▪ Prepare a Waste Management Plan approved by the Engineer/Supervising Officer of the Project based on current practices on construction sites. ▪ Training of site personnel in, site cleanliness, proper waste management and chemical handling procedures. ▪ Provision of sufficient waste disposal points and regular collection of waste. ▪ Appropriate measures to minimise windblown litter and dust during transportation of waste by either covering trucks or by transporting wastes in enclosed containers. ▪ Regular cleaning and maintenance programme for drainage systems, sumps and oil interceptors. ▪ Separation of chemical wastes for special handling and appropriate treatment. 	To implement good site practice for handling, sorting reuse and recycling of C&D materials	All works sites	Main Contractor	Waste Disposal Ordinance, Land (Miscellaneous Provisions) Ordinance, ETWB TC(W) No 31/2004		✓			Implemented
S.10.5.6.1		Recommendations for waste reduction measures: <ul style="list-style-type: none"> ▪ Sorting of demolition debris and excavated materials from demolition works to recover reusable/ recyclable portions (i.e. soil, broken concrete, metal etc.). ▪ Segregation and storage of different types of waste in different containers, skips or stockpiles to enhance reuse or 	To implement on-site sorting facilitating reuse and recycling of materials as well as proper disposal of waste	All works sites	Main Contractor	Waste Disposal Ordinance, Land (Miscellaneous Provisions) Ordinance		✓			Implemented

EIA Reference	EM&A Manual Reference	Environmental Protection Measures	Objectives of Measures and Main Concern to Address	Location	Implementation Agent	Relevant Standard or Requirement	Implementation Stages			Maintenance Agent	Implementation status
							D	C	O		
		recycling of materials and their proper disposal. <ul style="list-style-type: none"> ▪ Encourage collection of aluminium cans by providing separate labelled bins to enable this waste to be segregated from other general refuse generated by the workforce. ▪ Proper storage and site practices to minimize the potential for damage or contamination of construction materials. ▪ Plan and stock construction materials carefully to minimize amount of waste generated and avoid unnecessary generation of waste. ▪ Training should be provided to workers about the concepts of site cleanliness and appropriate waste management procedures, including waste reduction, reuse and recycle. 									
S.10.5.6.1		The Contractor should prepare and implement a Waste Management Plan as a part of the Environmental Management Plan in accordance with ETWB TCW No 19/2005 which describes the arrangements for avoidance, reuse, recovery, recycling, storage, collection, treatment and disposal of different categories of waste to be generated from the construction activities.	To keep trace of the generation, minimization, reuse and disposal of C&D materials in the Project	All works sites	Main Contractor	ETWB TCW No 19/2005		✓			Implemented
S.10.5.6.1		Storage of materials on-site may induce adverse environmental impacts if not properly managed, recommendations to minimise the impacts include: <ul style="list-style-type: none"> ▪ Waste, such as soil, should be handled and stored well to ensure secure containment, thus minimising the potential of pollution. ▪ Maintain and clean storage areas routinely. ▪ Stockpiling area should be provided with covers and water spraying system to prevent materials from wind-blown or being washed away. ▪ Different locations should be designated 	To minimise potential impacts of waste storage and enhance reusable volume	All works sites	Main Contractor	-		✓			Implemented

EIA Reference	EM&A Manual Reference	Environmental Protection Measures	Objectives of Measures and Main Concern to Address	Location	Implementation Agent	Relevant Standard or Requirement	Implementation Stages			Maintenance Agent	Implementation status
							D	C	O		
		to stockpile each material to enhance reuse.									
S.10.5.6.1		Waste hauliers must hold a valid permit for the collection of waste as stipulated in their permits. Removal of waste should be done in a timely manner.	To collect and remove waste generated	All works sites	Main Contractor	-		✓			Implemented
S.10.5.6.1		Implementation of trip-ticket system to monitor waste disposal and control fly-tipping. <ul style="list-style-type: none"> ▪ Set up warning signs at vehicular access points reminding drivers of designated disposal sites and penalties of an offence. ▪ Installation of close-circuited television at access points of vehicles to monitor and prevent illegal dumping. 	To monitor disposal of waste and control fly-tipping	All works sites	Main Contractor	ETWB TC(W) No 31/2004		✓			Implemented
S.10.5.6.1		Wheel washing facilities should be provided before the trucks leave the works area.	To minimise dust impact	All works sites	Main Contractor	-		✓			Implemented
S.10.5.6.1		The Contractor should ensure the on-site separation from inert portion. The waste delivered to landfill should not contain any free water or have water content more than 70% by weight. The haulier must ensure suitable amount of waste would be loaded on different types of trucks used. A one-week notice should be given to EPD with information on Contractor's name and respective contact details.	To meet the requirement for disposal at landfill	All works sites	Main Contractor	-		✓			Implemented
S.10.5.6.1		If chemical wastes are produced at the construction site, the Contractor would be required to register with the EPD as a chemical waste producer and to follow the guidelines stated in the Code of Practice on the Packaging, Labelling and Storage of Chemical Wastes. Containers used for storage of chemical waste should : <ul style="list-style-type: none"> ▪ Be compatible with the chemical wastes being stored, maintained in good condition and securely sealed. ▪ Have a capacity of less than 450 litres unless the specifications have been approved by EPD; and 	To properly store the chemical waste within works sites and works areas	All works sites	Main Contractor	Code of Practice on the Packaging, Labelling and Storage of Chemical Wastes		✓			Implemented

EIA Reference	EM&A Manual Reference	Environmental Protection Measures	Objectives of Measures and Main Concern to Address	Location	Implementation Agent	Relevant Standard or Requirement	Implementation Stages			Maintenance Agent	Implementation status
							D	C	O		
		<ul style="list-style-type: none"> Display a label in English and Chinese in accordance with instructions prescribed in Schedule 2 of the Waste Disposal (Chemical Waste) (General) Regulation. 									
S.10.5.6.1		<p>The chemical storage areas should:</p> <ul style="list-style-type: none"> Be clearly labelled to indicate corresponding chemical characteristics of the chemical waste and used for storage of chemical waste only. Be enclosed on at least 3 sides. Have an impermeable floor and bunding, of capacity to accommodate 110% of the volume of the largest container or 20% by volume of the chemical waste stored in that area, whichever is the greatest. Have adequate ventilation. Be covered to prevent rainfall from entering. Be properly arranged so that incompatible materials are adequately separated. 	To prepare appropriate storage areas for chemical waste at works areas	All works sites	Main Contractor	Code of Practice on the Packaging, Labelling and Storage of Chemical Wastes		✓			Implemented
S.10.5.6.1		Lubricants, waste oils and other chemical wastes would be generated during the maintenance of vehicles and mechanical equipments. Used lubricants should be collected and stored in individual containers which are fully labelled in English and Chinese and stored in a designated secure place.	To clearly label the chemical waste at works areas	All works sites	Main Contractor	Code of Practice on the Packaging, Labelling and Storage of Chemical Wastes		✓			Implemented
S.10.5.6.1		A trip-ticket system should be operated in accordance with the Waste Disposal (Chemical Waste) (General) Regulation to monitor all movements of chemical waste. The Contractor should employ a licensed collector to transport and dispose of the chemical wastes, to either the approved CWTC at Tsing Yi, or another licensed facility, in accordance with the Waste Disposal (Chemical Waste) (General) Regulation.	To monitor the generation, reuse and disposal of chemical waste	All works sites	Main Contractor	Waste Disposal (Chemical Waste) (General) Regulation		✓			Implemented

EIA Reference	EM&A Manual Reference	Environmental Protection Measures	Objectives of Measures and Main Concern to Address	Location	Implementation Agent	Relevant Standard or Requirement	Implementation Stages			Maintenance Agent	Implementation status
							D	C	O		
S.10.5.6.1		General refuse should be stored in enclosed bins or compaction units separate from C&D materials and chemical waste. A reputable waste collector should be employed by the contractor to remove general refuse from the site, separately from C&D materials and chemical wastes.	To properly store and separate from other C&D materials for subsequent collection and disposal	All works sites	Main Contractor	-		✓			Implemented
S.10.5.6.1		The recyclable component of general refuse, such as aluminium cans, paper and cleansed plastic containers should be separated from other waste. Provision and collection of recycling bins for different types of recyclable waste should be set up by the Contractor. The Contractor should also be responsible for arranging recycling companies to collect these materials.	To facilitate recycling of recyclable portions of refuse	All works sites	Main Contractor	-		✓			Implemented
S.10.5.6.1		The Contractor should carry out a training programme for workers in avoiding, reducing, reusing and recycling of materials generation. Posters and leaflets advising on the use of the bins should also be provided in the sites as reminders.	To raise workers' awareness on recycling issue	All works sites	Main Contractor	-		✓			Implemented
S.10.6.4		Chemical waste during the operation of the KTE project: <ul style="list-style-type: none"> ▪ The requirements stipulated in the Code of Practice on the Packaging, Labelling and Storage of Chemical Wastes should be followed in handling of chemical waste as in construction phase. ▪ A trip-ticket system should be operated in accordance with the Waste Disposal (Chemical Waste) (General) Regulation to monitor all movements of chemical wastes which would be collected by a licensed collector to a licensed facility for final treatment and disposal. ▪ The recommendations proposed for the mitigation of impacts from chemical waste in construction phase should also be followed. 	To avoid environmental impacts in handling, storage and disposal of chemical waste	Ventilation building and Stations	MTR Corporation	Code of Practice on the Packaging, Labelling and Storage of Chemical Wastes, Waste Disposal (Chemical Waste) (General) Regulation			✓		Implemented
S.10.6.4		General refuse during the operation of the	To separate the general refuse from other waste	Ventilation building and	MTR Corporation	-			✓		Implemented

EIA Reference	EM&A Manual Reference	Environmental Protection Measures	Objectives of Measures and Main Concern to Address	Location	Implementation Agent	Relevant Standard or Requirement	Implementation Stages			Maintenance Agent	Implementation status
							D	C	O		
		KTE project: <ul style="list-style-type: none"> Provide recycling bins at designated areas for proper recycling of papers, aluminium cans and plastics bottles. Separation from other waste types and collected by licensed collectors at daily basis to minimize the potential impacts from odour and vermin. 	types and proper disposal of the refuse	Stations							
S.10.6.4		Industrial waste during the operation of the KTE project: <ul style="list-style-type: none"> Separation of reusable components like steel before collection by licensed collector 	To recycle useful materials from industrial waste and proper disposal	Ventilation building and Stations	MTR Corporation	-		✓			Implemented
Hazard to Life											
S.12.12.1, S.12.12.6	Section 12.10.2.1, Section 12.10.2.4	Improved truck design to reduce the amount of combustibles in, front exhaust spark arrester, 1 x 9 kg water based and 1 x 9 kg dry chemical powder fire extinguishers. This should be combined with monthly vehicle inspection.	To meet the ALARP requirement.	Temporary explosives magazine	MTR Corporation/ Main Contractor	-		✓		-	Implemented
S.12.12.1	Section 12.10.2.1	The explosive truck accident frequency should be minimized by implementing a dedicated training programme for both the driver and his attendants, including regular briefing sessions, implementation of a defensive driving attitude. In addition, drivers should be selected based on good safety record, and medical checks.	To meet the ALARP requirement.	-	MTR Corporation/ Main Contractor	-		✓		-	Implemented
S.12.12.1	Section 12.10.2.1	The contractor should as far as practicable combine the explosive deliveries for a given work area.	To meet the ALARP requirement.	-	MTR Corporation/ Main Contractor	-		✓		-	Implemented
S.12.12.1	Section 12.10.2.1	The explosive truck fire involvement frequency should be minimized by implementing a better emergency response and training to make sure the adequate fire extinguishers are used and attempt is made to evacuate the area of the incident or securing the explosive load if possible. All explosive vehicles should also be equipped with bigger	To meet the ALARP requirement.	-	MTR Corporation/ Main Contractor	-		✓		-	Implemented

EIA Reference	EM&A Manual Reference	Environmental Protection Measures	Objectives of Measures and Main Concern to Address	Location	Implementation Agent	Relevant Standard or Requirement	Implementation Stages			Maintenance Agent	Implementation status
							D	C	O		
		capacity AFFF-type extinguishers.									
S.12.12.1	Section 12.10.2.1	A minimum headway between two consecutive truck conveyors of at least 10 min is recommended	To meet the ALARP requirement.	Along explosives transport routes	MTR Corporation/ Main Contractor	-		✓		-	Implemented
S.12.12.2	Section 12.10.2.2	Blasting activities including storage and transport of explosives should be supervised and audited by competent site staff to ensure strict compliance with the blasting permit conditions.	To ensure that the risks from the proposed explosives storage would not be unacceptable	Works areas at which explosives would be stored and/or used.	MTR Corporation/ Main Contractor	Dangerous Goods Ordinance		✓		-	Implemented
S.12.12.1 & S.12.12.7.2	Section 12.10.2.1 & Section 12.10.2.5	Only the required quantity of explosives for a particular blast should be transported to avoid the return of unused explosives to the temporary magazine. The number of return trips to the temporary magazine with the full load of explosives or partial load should be minimised by proper co-ordination between blasting and delivery. If disposal is required for small quantities, disposal should be made in a controlled and safe manner by a Registered Shotfirer.	To reduce the risk during explosives transport.	Works areas at which explosives would be stored and/ or used.	MTR Corporation/ Main Contractor	-		✓		-	Implemented
S.12.12.5	Section 12.10.2.4	Use only experienced driver(s) with good safety record for explosive vehicle(s). Training should be provided to ensure it covers all major safety subjects.	To ensure safe transport of explosives.	At suitable location	MTR Corporation/ Main Contractor	-		✓		-	Implemented
S.12.12.5	Section 12.10.2.4	Develop procedure to ensure that parking space on the site is available for the explosives truck. Confirmation of parking space should be communicated to truck drivers before delivery.	To ensure that the risks from the proposed explosives storage would not be unacceptable	Temporary explosives magazine	MTR Corporation/ Main Contractor	-		✓		-	Implemented
S.12.12.3	Section 12.10.2.3	Delivery vehicles shall not be permitted to remain unattended within the temporary magazine site (or appropriately wheel-locked).	To reduce the risk of fire within the magazine	Temporary explosives magazine	MTR Corporation/ Main Contractor	-		✓		-	Implemented
S.12.12.3	Section 12.10.2.3	Good house-keeping within and outside of the temporary magazine to ensure that combustible materials (including vegetation)	To reduce the risk of fire within the magazine	Temporary explosives	MTR Corporation/ Main Contractor	-		✓		-	Implemented

EIA Reference	EM&A Manual Reference	Environmental Protection Measures	Objectives of Measures and Main Concern to Address	Location	Implementation Agent	Relevant Standard or Requirement	Implementation Stages			Maintenance Agent	Implementation status
							D	C	O		
		are removed and not allowed to accumulate.		magazine							
S.12.12.5	Section 12.10.2.4	Detonators shall not be transported in the same vehicle with other Class 1 explosives.	To reduce the risk of explosion during the transport of cartridged emulsion	-	MTR Corporation/ Main Contractor	-		✓		-	Implemented
S.12.12.2	Section 12.10.2.2	Emergency plan (i.e. temporary magazine operational manual) shall be developed to address uncontrolled fire in temporary magazine area. The case of fire near an explosive carrying truck in jammed traffic should also be covered. Drill of the emergency plan should be carried out at regular intervals.	To reduce the risk of fire.	Temporary explosives magazine and along explosives transport routes	MTR Corporation/ Main Contractor	-		✓		-	Implemented
S.12.12.2	Section 12.10.2.2	Adverse weather working guideline should be developed to clearly define procedure for transport explosives during thunderstorm.	To ensure safe transport of explosives.	Along explosives transport routes	MTR Corporation/ Main Contractor	-		✓		-	Implemented
S.12.12.2	Section 12.10.2.2	The magazine storage quantities need to be reported on a monthly basis to ensure that the two day storage capacity is not exceeded.	To reduce the risk within the magazine	Temporary explosives magazine	MTR Corporation/ Main Contractor	-		✓		-	Implemented
S.12.12.5	Section 12.10.2.4	During transport of the explosives within the tunnel, hot work should not be permitted in the vicinity of the explosives offloading or charging activities.	To ensure safe transport of explosives.	Along explosives transport routes	MTR Corporation/ Main Contractor	-		✓		-	Implemented
S.12.12.5	Section 12.10.2.4	Ensure that UN 1.4B packaging of detonators remains intact until handed over at blasting site.	To reduce the risk of explosion during the transport of detonator.	-	MTR Corporation/ Main Contractor	-		✓		-	Implemented
S.12.12.6	Section 12.10.2.4	Steel vehicle tray welded to a steel vertical fire screen should be mounted at least 150 mm behind the drivers cab and 100 mm from the steel cargo compartment, the vertical screen shall protrude 150 mm in excess of all three (3) sides of the steel cargo compartment	To reduce the risk during explosives transport.	-	MTR Corporation/ Main Contractor	-		✓		-	Implemented
S.12.12.10	Section 12.10.2.5	Ensure cartridged emulsion with high water content should be preferred. Also, the emulsion with perchlorate formulation	To ensure safe explosives to be used.	-	MTR Corporation/ Main Contractor	-		✓		-	Implemented

EIA Reference	EM&A Manual Reference	Environmental Protection Measures	Objectives of Measures and Main Concern to Address	Location	Implementation Agent	Relevant Standard or Requirement	Implementation Stages			Maintenance Agent	Implementation status
							D	C	O		
		should be avoided.									
S.12.12.3	Section 12.10.2.3	Traffic Management should be implemented within the temporary magazine site, to ensure that no more than 1 vehicle will be loaded at any time, in order to avoid accidents involving multiple vehicles within the site boundary. Based on the construction programme, considering that 6 trucks could be loaded over a peak 2 hour period, this is considered feasible.	To ensure that the risks from the proposed explosives storage and transport would not be unacceptable	Temporary explosives magazine	MTR Corporation/ Main Contractor	-		✓		-	Implemented
S.12.12.3	Section 12.10.2.3	The design of the fill slope close to the temporary magazine site should consider potential washout failures and incorporate engineering measures to prevent a washout causing damage to the temporary magazine stores	To ensure that the risks from the proposed explosives storage would not be unacceptable	Temporary explosives magazine	MTR Corporation/ Main Contractor/ Fill Bank Office	-		✓		-	Implemented
S.12.12.2	Section 12.10.2.2	The security plan should address different alert security level to reduce opportunity for arson / deliberate initiation of explosives. The corresponding security procedure should be implemented with respect to prevailing security alert status announced by the Government.	To ensure that the risks from the proposed explosives storage would not be unacceptable	Temporary explosives magazine	MTR Corporation/ Main Contractor	-		✓		-	Implemented
S.12.12.3	Section 12.10.2.3	A suitable work control system should be introduced, such as an operational manual including Permit-to-Work system.	To ensure that the risks from the proposed explosives storage would not be unacceptable	Temporary explosives magazine	MTR Corporation/ Main Contractor	-		✓		-	Implemented
S.12.12.3	Section 12.10.2.3	The magazine building shall be regularly checked for water seepage through the roof, walls or floor.	To ensure that the risks from the proposed explosives storage would not be unacceptable	Temporary explosives magazine	MTR Corporation/ Main Contractor	-		✓		-	Implemented

Note: D = Design
 C = Construction
 O = Operation

Appendix E

Calibration Details

Certificate of Calibration

校正證書

Certificate No. : C136320
證書編號

ITEM TESTED / 送檢項目 (Job No. / 序引編號 : IC13-2604)

Description / 儀器名稱 : Sound Level Meter
Manufacturer / 製造商 : Brüel & Kjær
Model No. / 型號 : 2250
Serial No. / 編號 : 2704791
Supplied By / 委託者 : EDMS Consulting Ltd.
Unit 1C, 24/F., World Wide House, 19 Des Voeux Road Central,
Hong Kong

TEST CONDITIONS / 測試條件

Temperature / 溫度 : (23 ± 2)°C
Relative Humidity / 相對濕度 : (55 ± 20)%
Line Voltage / 電壓 : ---

TEST SPECIFICATIONS / 測試規範

Calibration check

DATE OF TEST / 測試日期 : 7 October 2013

TEST RESULTS / 測試結果

The results apply to the particular unit-under-test only.
All results are within manufacturer's specification.
The results are detailed in the subsequent page(s).

The test equipment used for calibration are traceable to National Standards via :

- The Government of The Hong Kong Special Administrative Region Standard & Calibration Laboratory
- Rohde & Schwarz Laboratory, Germany
- Fluke Everett Service Center, USA
- Agilent Technologies, USA

Tested By : 
測試 : K C Lee

Certified By : 
核證 : K M Wu

Date of Issue : 8 October 2013
簽發日期

The test equipment used for calibration are traceable to the Nation Standards as specified in this certificate. This certificate shall not be reproduced except in full, without the prior written approval of this laboratory.

本證書所載校正用之測試器材均可溯源至國際標準。局部複印本證書需先獲本實驗室書面批准。

Certificate of Calibration

校正證書

Certificate No. : C136320
證書編號

- The unit-under-test (UUT) was allowed to stabilize in the laboratory for over 12 hours, and switched on to warm up for over 10 minutes before the commencement of the test.
- Self-calibration using laboratory acoustic calibrator was performed before the test 6.1.1.2 to 6.3.2.
- The results presented are the mean of 3 measurements at each calibration point.
- Test equipment :

<u>Equipment ID</u>	<u>Description</u>	<u>Certificate No.</u>
CL280	40 MHz Arbitrary Waveform Generator	C130019
CL281	Multifunction Acoustic Calibrator	DC130171

- Test procedure : MA101N.

- Results :

6.1 Sound Pressure Level

6.1.1 Reference Sound Pressure Level

6.1.1.1 Before Self-calibration

UUT Setting		Applied Value		UUT Reading (dB)
Range (dB)	Main	Level (dB)	Freq. (kHz)	
20 - 140	LAF (SPL)	94.00	1	94.2

6.1.1.2 After Self-calibration

UUT Setting		Applied Value		UUT Reading (dB)	IEC 61672 Class 1 Spec. (dB)
Range (dB)	Main	Level (dB)	Freq. (kHz)		
20 - 140	LAF (SPL)	94.00	1	94.0	± 1.1

6.1.2 Linearity

UUT Setting		Applied Value		UUT Reading (dB)
Range (dB)	Main	Level (dB)	Freq. (kHz)	
20 - 140	LAF (SPL)	94.00	1	94.0 (Ref.)
		104.00		104.0
		114.00		114.0

IEC 61672 Class 1 Spec. : ± 0.6 dB per 10 dB step and ± 1.1 dB for overall different.

The test equipment used for calibration are traceable to the Nation Standards as specified in this certificate. This certificate shall not be reproduced except in full, without the prior written approval of this laboratory.

本證書所載校正用之測試器材均可溯源至國際標準。局部複印本證書需先獲本實驗室書面批准。

Certificate of Calibration

校正證書

Certificate No. : C136320

證書編號

6.2 Time Weighting

UUT Setting		Applied Value		UUT Reading (dB)	IEC 61672 Class 1 Spec. (dB)
Range (dB)	Main	Level (dB)	Freq. (kHz)		
20 - 140	LAF (SPL)	94.00	1	94.0	Ref.
	LAS (SPL)			94.0	± 0.3

6.3 Frequency Weighting

6.3.1 A-Weighting

UUT Setting		Applied Value		UUT Reading (dB)	IEC 61672 Class 1 Spec. (dB)
Range (dB)	Main	Level (dB)	Freq.		
20 - 140	LAF (SPL)	94.00	63 Hz	67.8	-26.2 ± 1.5
			125 Hz	77.8	-16.1 ± 1.5
			250 Hz	85.3	-8.6 ± 1.4
			500 Hz	90.7	-3.2 ± 1.4
			1 kHz	94.0	Ref.
			2 kHz	95.2	+1.2 ± 1.6
			4 kHz	95.0	+1.0 ± 1.6
			8 kHz	92.9	-1.1(+2.1 ; -3.1)
			12.5 kHz	89.3	-4.3(+3.0 ; -6.0)

6.3.2 C-Weighting

UUT Setting		Applied Value		UUT Reading (dB)	IEC 61672 Class 1 Spec. (dB)
Range (dB)	Main	Level (dB)	Freq.		
20 - 140	LCF (SPL)	94.00	63 Hz	93.2	-0.8 ± 1.5
			125 Hz	93.8	-0.2 ± 1.5
			250 Hz	94.0	0.0 ± 1.4
			500 Hz	94.0	0.0 ± 1.4
			1 kHz	94.0	Ref.
			2 kHz	93.8	-0.2 ± 1.6
			4 kHz	93.2	-0.8 ± 1.6
			8 kHz	91.0	-3.0 (+2.1 ; -3.1)
			12.5 kHz	87.4	-6.2 (+3.0 ; -6.0)

The test equipment used for calibration are traceable to the Nation Standards as specified in this certificate. This certificate shall not be reproduced except in full, without the prior written approval of this laboratory.

本證書所載校正用之測試器材均可溯源至國際標準。局部複印本證書需先獲本實驗室所書面批准。



Certificate of Calibration

校正證書

Certificate No. : C136320
證書編號

- Remarks : - UUT Microphone Model No. : 4189 & S/N : 2680937
- Mfr's Spec. : IEC 61672 Class 1
 - Uncertainties of Applied Value : 94 dB : 63 Hz - 125 Hz : ± 0.35 dB
250 Hz - 500 Hz : ± 0.30 dB
1 kHz : ± 0.20 dB
2 kHz - 4 kHz : ± 0.35 dB
8 kHz : ± 0.45 dB
12.5 kHz : ± 0.70 dB
104 dB : 1 kHz : ± 0.10 dB (Ref. 94 dB)
114 dB : 1 kHz : ± 0.10 dB (Ref. 94 dB)
 - The uncertainties are for a confidence probability of not less than 95 %.

Note :

The values given in this Certificate only relate to the values measured at the time of the test and any uncertainties quoted will not include allowance for the equipment long term drift, variations with environment changes, vibration and shock during transportation, overloading, mis-handling, or the capability of any other laboratory to repeat the measurement. Sun Creation Engineering Limited shall not be liable for any loss or damage resulting from the use of the equipment.

The test equipment used for calibration are traceable to the Nation Standards as specified in this certificate. This certificate shall not be reproduced except in full, without the prior written approval of this laboratory.

本證書所載校正用之測試器材均可溯源至國際標準。局部複印本證書需先獲本實驗室書面批准。



MAXLAB

CALIBRATION CERTIFICATE

Certificate Information

Date of Issue 18th January, 2013

Certificate Number MLCN130055S

Customer Information

Company Name MTR Corporation Limited
Address MTR Tower, Telford Plaza,
33 Wai Yip St., Kowloon Bay,
Kowloon,
Hong Kong

Unit Under Test (UUT)

Description Sound Level Calibrator
Manufacturer Brüel & Kjær
Model Number 4231
Serial Number 1795388
Equipment Number -

Calibration Result

- * All calibration results within the manufacturer's specification after adjustment.
- * Calibration data are detailed on the attached sheet(s).

Approved By

Laboratory Manager

- * Calibration equipment used for this calibration are traceable to national / international standards.
- * The results on this Calibration Certificate only relate to the values measured at the time of the calibration and the uncertainties quoted will not include allowance for the UUT long term drift, variation with environmental changes, vibration and shock during transportation, overloading, mishandling, misuse, and the capacity of any other laboratory to repeat the measurement.
- * MaxLab Calibration Centre Limited shall not be liable for any loss or damage resulting from the use of the UUT.
- * The copy of this Certificate is owned by MaxLab Calibration Centre Limited. No part of this Certificate may be reproduced without the prior written approval of MaxLab Calibration Centre Limited.



MAXLAB

CALIBRATION CERTIFICATE

Certificate Information

Date of Issue 18th January, 2013 **Certificate Number** MLCN130055S

Calibration Status

Date of Calibration 18th January, 2013
Calibration Equipment Used 4231 (Spec) (MLTE008)/ DC120076/ 29th Mar 2014
1351 (MLTE049)/ MLEC12/06/04/ 11th Jun 2013
Calibration Procedure MLCG00 & MLCG15.
Calibration Uncertainty ± 0.15 dB

Calibration Condition	Lab	Temperature	23 °C ± 5 °C
		Relative Humidity	55% ± 25%
	UUT	Stabilizing Time	Over 3 hours
		Warm-up Time	Not applicable
		Supply Voltage	Internal battery

Calibration Data

UUT Setting	STD Rdg	UUT Error	UUT Error Limit
94 dB	94.0 dB	0.0 dB	0.2 dB
114 dB	114.1 dB	0.1 dB	0.2 dB

ANDERSEN INSTRUMENTS INC.

GS2310 Series Sampler Calibration

(Dickson Recorder)

Customer -> MTRC

SITE Certificate -> 20140604

Location -> Methodist School

Date -> 31-May-14

Sampler -> 1294-1112

Tech -> Chan Kin Fung

CONDITIONS

Sea Level Pressure	(hpa)	1008.5	Sampler Elevation	(feet)	60
Sea Level Pressure	(in Hg)	29.78	Corrected Pressure	(mm Hg)	754.86
Temperature	(deg C)	33	Temperature	(deg K)	306.00
Seasonal SL Pressure	(in Hg)	29.78	Corrected Seasonal	(mm Hg)	754.86
Seasonal Temperature	(deg C)	33.00	Seasonal Temperature	(deg K)	306.00

CALIBRATION ORIFICE

Make -> Andersen Instruments Inc.

Qstd Slope -> 2.0075

Model -> G25A

Qstd Intercept -> -0.038138

Serial# -> 157N

Date Certified ->

CALIBRATION

	Plate or	H ₂ O	Qstd	I	IC	LINEAR	
	Test #	(in)	(M ³ /min)	(chart)	(corrected)	REGRESSION	
1	18	12.2	1.730	62	60.977	Slope =	33.5646
2	13	9.8	1.553	56	55.076	Intercept =	2.7739
3	10	7.6	1.370	49	48.191	Corr. Coeff. =	0.9996
4	7	5	1.114	41	40.323		
5	5	3.1	0.882	33	32.455		

Calculations

$$Qstd = 1/m [\text{Sqrt} (H_2O (Pa/Pstd) (Tstd/Ta)) - b]$$

$$IC = I [\text{Sqrt} (Pa/Pstd) (Tstd/Ta)]$$

Qstd = standard flow rate

IC = corrected chart response

I = actual chart response

m = calibrator Qstd slope

b = calibrator Qstd intercept

Ta = actual temperature during calibration (deg K)

Pa = actual pressure during calibration (mm Hg)

Tstd = 298 deg K

Pstd = 760 mm Hg

For subsequent calculation of sampler flow:

$$1/m ((I) [\text{Sqrt} (298/Tav) (Pav/760)] - b)$$

m = sampler slope

b = sampler intercept

I = chart response

Tav = daily average temperature

Pav = daily average pressure



Handwritten signature in blue ink.

This is to certify that the above equipment has been calibrated in accordance with manufacturer's procedure.

ANDERSEN INSTRUMENTS INC.

GS2310 Series Sampler Calibration

(Dickson Recorder)

Customer -> MTRC

SITE Certificate -> 20140603

Location -> Poly U Hall

Date -> 31-May-14

Sampler -> 1294-1109

Tech -> Chan Kin Fung

CONDITIONS

Sea Level Pressure	(hpa)	1009	Sampler Elevation	(feet)	260
Sea Level Pressure	(in Hg)	29.80	Corrected Pressure	(mm Hg)	750.18
Temperature	(deg C)	32	Temperature	(deg K)	305.00
Seasonal SL Pressure	(in Hg)	29.80	Corrected Seasonal	(mm Hg)	750.18
Seasonal Temperature	(deg C)	32.00	Seasonal Temperature	(deg K)	305.00

CALIBRATION ORIFICE

Make -> Andersen Instruments Inc.

Qstd Slope -> 2.0075

Model -> G25A

Qstd Intercept -> -0.038138

Serial# -> 157N

Date Certified ->

CALIBRATION

	Plate or	H ₂ O	Qstd	I	IC	LINEAR	
	Test #	(in)	(M ³ /min)	(chart)	(corrected)	REGRESSION	
1	18	11.9	1.707	60	58.923	Slope =	35.3307
2	13	9.6	1.535	54	53.031	Intercept =	-1.2997
3	10	7.6	1.368	48	47.139	Corr. Coeff. =	0.9999
4	7	4.9	1.102	38	37.318		
5	5	3	0.866	30	29.462		

Calculations

$$Qstd = 1/m [\text{Sqrt} (H_2O (Pa/Pstd) (Tstd/Ta)) - b]$$

$$IC = I [\text{Sqrt} (Pa/Pstd) (Tstd/Ta)]$$

Qstd = standard flow rate

IC = corrected chart response

I = actual chart response

m = calibrator Qstd slope

b = calibrator Qstd intercept

Ta = actual temperature during calibration (deg K)

Pa = actual pressure during calibration (mm Hg)

Tstd = 298 deg K

Pstd = 760 mm Hg

For subsequent calculation of sampler flow:

$$1/m ((I) [\text{Sqrt} (298/Tav) (Pav/760)] - b)$$

m = sampler slope

b = sampler intercept

I = chart response

Tav = daily average temperature

Pav = daily average pressure



This is to certify that the above equipment has been calibrated in accordance with manufacturer's procedure.

ANDERSEN INSTRUMENTS INC.

GS2310 Series Sampler Calibration

(Dickson Recorder)

Customer -> MTRC

SITE

Certificate -> 20140602

Location -> Fung Kei MPS

Date -> 31-May-14

Sampler -> 1294-1110

Tech -> Chan Kin Fung

CONDITIONS

Sea Level Pressure	(hpa)	1009	Sampler Elevation	(feet)	100
Sea Level Pressure	(in Hg)	29.80	Corrected Pressure	(mm Hg)	754.22
Temperature	(deg C)	30	Temperature	(deg K)	303.00
Seasonal SL Pressure	(in Hg)	29.80	Corrected Seasonal	(mm Hg)	754.22
Seasonal Temperature	(deg C)	30.00	Seasonal Temperature	(deg K)	303.00

CALIBRATION ORIFICE

Make -> Andersen Instruments Inc.

Qstd Slope -> 2.0075

Model -> G25A

Qstd Intercept -> -0.038138

Serial# -> 157N

Date Certified ->

CALIBRATION

	Plate or Test #	H ₂ O (in)	Qstd (M ³ /min)	I (chart)	IC (corrected)	LINEAR REGRESSION
	1	18	1.710	59	58.288	Slope = 34.8177
	2	13	1.544	54	53.349	Intercept = -0.4754
	3	10	1.376	49	48.409	Corr. Coeff. = 0.9979
	4	7	1.108	39	38.530	
	5	5	0.885	30	29.638	

Calculations

$$Qstd = 1/m [\text{Sqrt} (H_2O (Pa/Pstd) (Tstd/Ta)) - b]$$

$$IC = I [\text{Sqrt} (Pa/Pstd) (Tstd/Ta)]$$

Qstd = standard flow rate

IC = corrected chart response

I = actual chart response

m = calibrator Qstd slope

b = calibrator Qstd intercept

Ta = actual temperature during calibration (deg K)

Pa = actual pressure during calibration (mm Hg)

Tstd = 298 deg K

Pstd = 760 mm Hg

For subsequent calculation of sampler flow:

$$1/m ((I) [\text{Sqrt} (298/Tav) (Pav/760)] - b)$$

m = sampler slope

b = sampler intercept

I = chart response

Tav = daily average temperature

Pav = daily average pressure



Handwritten signature in blue ink.

This is to certify that the above equipment has been calibrated in accordance with manufacturer's procedure.

ANDERSEN INSTRUMENTS INC.

GS2310 Series Sampler Calibration

(Dickson Recorder)

Customer -> MTRC

SITE

Certificate -> 20140601

Location -> Ka Fu Building

Date -> 31-May-14

Sampler -> 994-0874

Tech -> Chan Kin Fung

CONDITIONS

Sea Level Pressure	(hpa)	1009	Sampler Elevation	(feet)	100
Sea Level Pressure	(in Hg)	29.80	Corrected Pressure	(mm Hg)	754.22
Temperature	(deg C)	31	Temperature	(deg K)	304.00
Seasonal SL Pressure	(in Hg)	29.80	Corrected Seasonal	(mm Hg)	754.22
Seasonal Temperature	(deg C)	31.00	Seasonal Temperature	(deg K)	304.00

CALIBRATION ORIFICE

Make -> Andersen Instruments Inc.

Qstd Slope -> 2.0075

Model -> G25A

Qstd Intercept -> -0.038138

Serial# -> 157N

Date Certified ->

CALIBRATION

	Plate or	H ₂ O	Qstd	I	IC	LINEAR	
	Test #	(in)	(M ³ /min)	(chart)	(corrected)	REGRESSION	
1	18	13	1.790	60	59.179	Slope =	29.6227
2	13	10.1	1.580	54	53.261	Intercept =	6.2725
3	10	7.7	1.382	48	47.343	Corr. Coeff. =	0.9999
4	7	5.1	1.129	40	39.453		
5	5	3.1	0.884	33	32.548		

Calculations

$Qstd = 1/m [\text{Sqrt} (H_2O (Pa/Pstd) (Tstd/Ta)) - b]$

$IC = I [\text{Sqrt} (Pa/Pstd) (Tstd/Ta)]$

Qstd = standard flow rate

IC = corrected chart response

I = actual chart response

m = calibrator Qstd slope

b = calibrator Qstd intercept

Ta = actual temperature during calibration (deg K)

Pa = actual pressure during calibration (mm Hg)

Tstd = 298 deg K

Pstd = 760 mm Hg

For subsequent calculation of sampler flow:

$1/m ((I) [\text{Sqrt} (298/Tav) (Pav/760)] - b)$

m = sampler slope

b = sampler intercept

I = chart response

Tav = daily average temperature

Pav = daily average pressure



Handwritten signature in blue ink.

This is to certify that the above equipment has been calibrated in accordance with manufacturer's procedure.

AECOM Asia Company Limited

TSP High Volume Sampler

Field Calibration Report

Station: 234 - 238 Chatham Road North; SCL - DMS - 11 Operator: Shum Kam Yuen
 Cal. Date: 7-Jul-14 Next Due Date: 7-Sep-14
 Equipment No.: --- Serial No. 8259

Ambient Condition			
Temperature, Ta (K)	303.5	Pressure, Pa (mmHg)	751.5

Orifice Transfer Standard Information					
Serial No:	843	Slope, mc	1.99102	Intercept, bc	-0.00616
Last Calibration Date:	9-Dec-13	$mc \times Qstd + bc = [H \times (Pa/760) \times (298/Ta)]^{1/2}$			
Next Calibration Date:	9-Dec-14				

Calibration of TSP Sampler					
Resistance Plate No.	Orifice			HVS Flow Recorder	
	DH (orifice), in. of water	[DH x (Pa/760) x (298/Ta)] ^{1/2}	Qstd (m ³ /min) X-axis	Flow Recorder Reading (CFM)	Continuous Flow Recorder Reading IC (CFM) Y-axis
18	8.1	2.80	1.41	46.0	45.33
13	6.7	2.55	1.28	39.0	38.43
10	5.4	2.29	1.15	33.0	32.52
7	4.2	2.02	1.02	27.0	26.60
5	3.0	1.71	0.86	20.0	19.71

By Linear Regression of Y on X

Slope, mw = 45.9896 Intercept, bw = -20.1546

Correlation Coefficient* = 0.9981

*If Correlation Coefficient < 0.990, check and recalibrate.

Set Point Calculation

From the TSP Field Calibration Curve, take Qstd = 1.30m³/min

From the Regression Equation, the "Y" value according to

$$mw \times Qstd + bw = IC \times [(Pa/760) \times (298/Ta)]^{1/2}$$

Therefore, Set Point; IC = (mw x Qstd + bw) x [(760 / Pa) x (Ta / 298)]^{1/2} = 40.22

Remarks: _____

QC Reviewer: WS CHAN

Signature: [Signature]

Date: 8/7/14

Balance Calibration Report
Tested to MTRC Method WI/707M/01

Laboratory Equipment Identification Number			BA0011		
Manufacturer	Sartorius	Model	A200S-**DIB	Serial No.	1065989
Capacity	120g	Discrimination	0.1mg	Type	Top Loading
Location	Concrete Testing Area		Temperature	24°C	

Reference Mass Set Used (Equip. ID. No.)		RM001	
Manufacturer	Troemner	OIML Classification	F1
Last Calibration Date	29-04-2002	Calibrated By	South China National Centre of Metrology

(1) Repeatability of Reading

Reference Mass (g)	Standard Deviation of Balance Reading (g)	Maximum Difference Between Successive Readings (g)
10	0.000094	0.0002
60	0.000079	0.0002
120	0.000042	0.0001

Standard Deviation of the Balance = 0.000422 g

(2) Departure from Nominal Value

Reading (g)	Correction (g)	Uncertainty (g)
09.9998	0.00020	±0.000301
19.9980	0.00025	
29.9999	0.00015	
39.9997	0.00043	
49.9998	0.00017	
59.9996	0.00032	
69.9996	0.00037	
79.9996	0.00042	
89.9996	0.00045	
99.9993	0.00050	

Maximum Correction = 0.00050 g

(3) **Off-Centre Loading**

A mass of approximately 10000g was moved to various position on the balance pan. The balance readings obtained at different position are given in the table.

Centre	Front	Back	Left	Right
59.9986	59.9984	59.9981	59.9987	59.9988

Maximum Difference = 0.0007 g

(4) **Hysteresis**

Load (g)	Hysteresis (g)
50	0.000367

(5) **Limit of Performance of the Balance = ± 0.000783 g**

Checked by : Dick Lee Certified by : *[Signature]*
 Date : 14-02-2011 Date : 14/2/2011

Notes:

- 1.The balance has been tested according to the specifications laid down in Chapter 6 of the CSIRO Publication "The Calibration of Balances - by David B. Prowse".
- 2.Uncertainties quoted in this report have been estimated on the basis of there being not more than one chance in one hundred that any value differs from the true value by more than the stated uncertainty.
- 3.The Limit of Performance is the tolerance band within which all readings of the balance will fall.

Appendix F

Impact Monitoring Graphical Plots

24-Hour TSP Level Monitoring Results

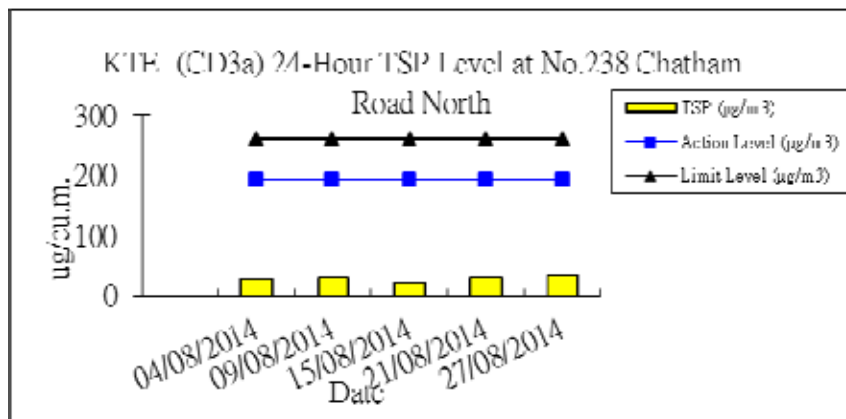
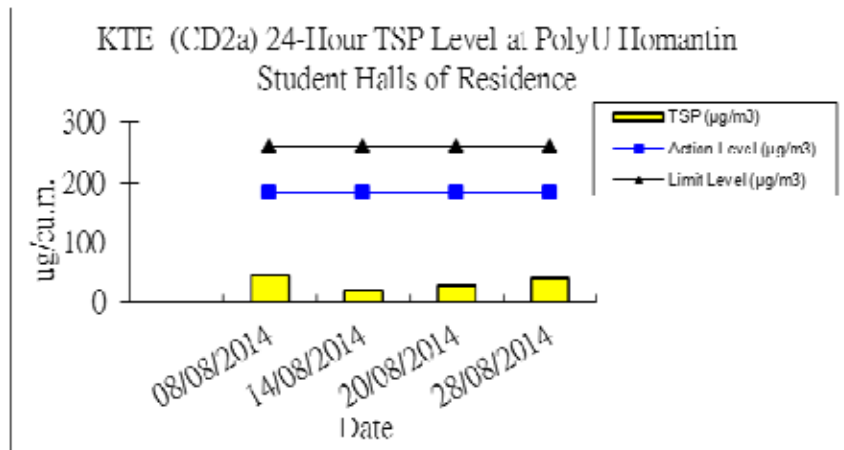
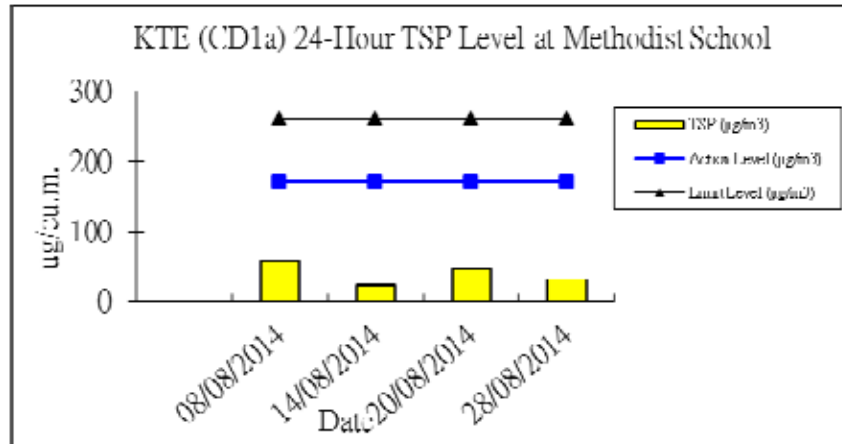

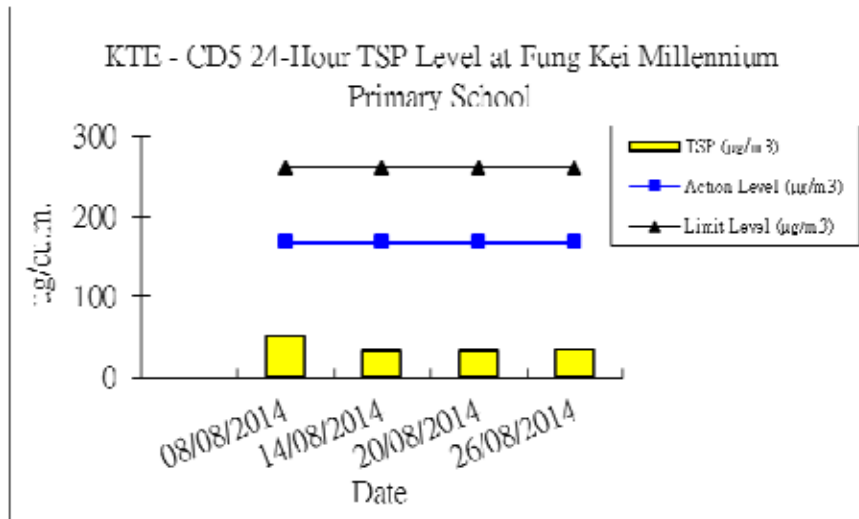
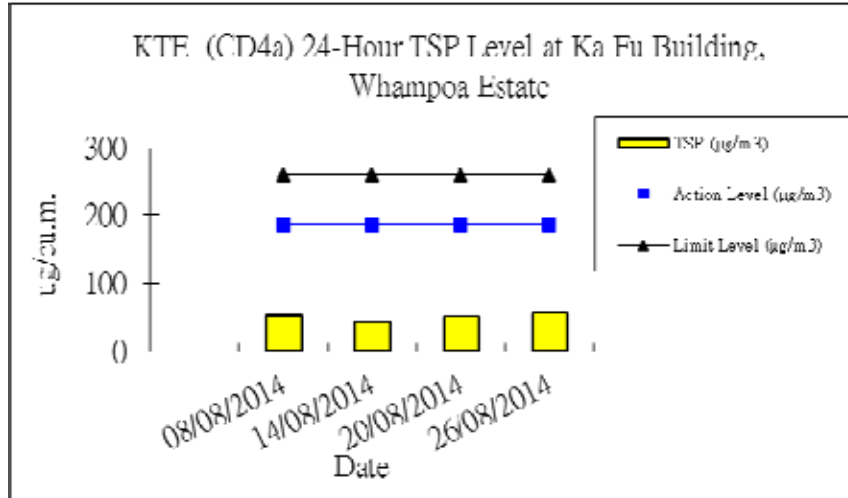

Noise Level Monitoring results

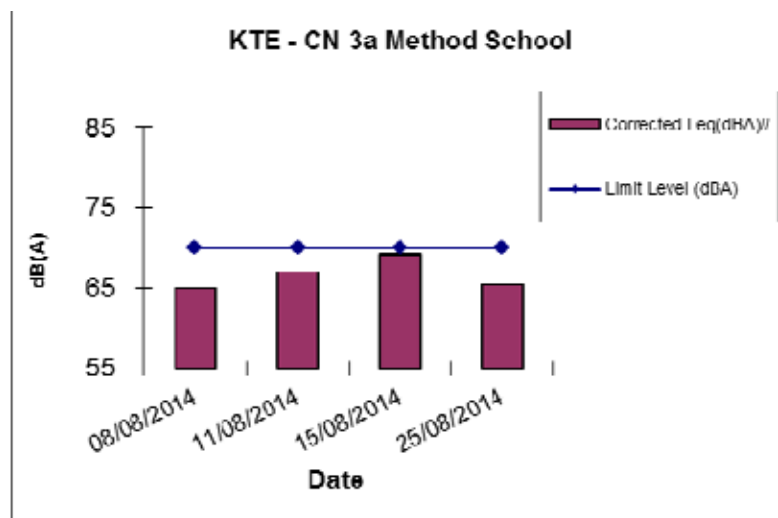
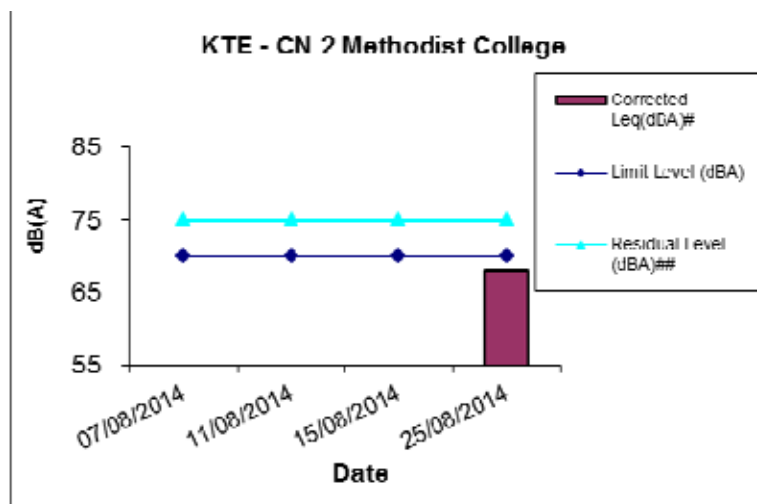
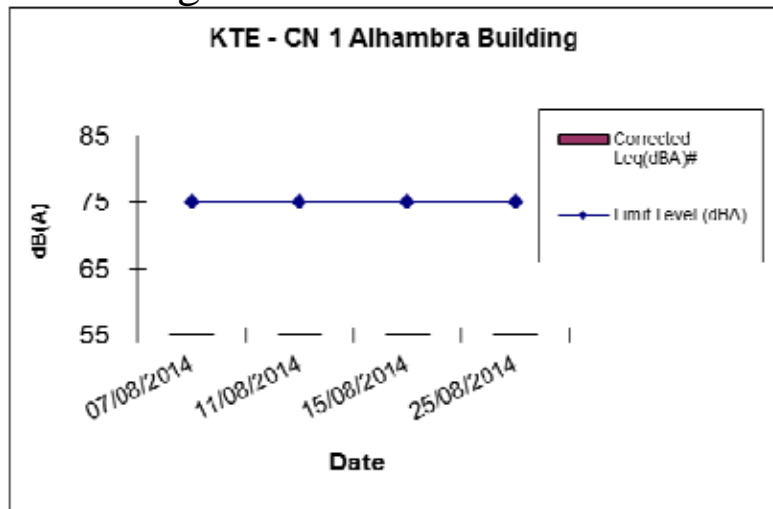

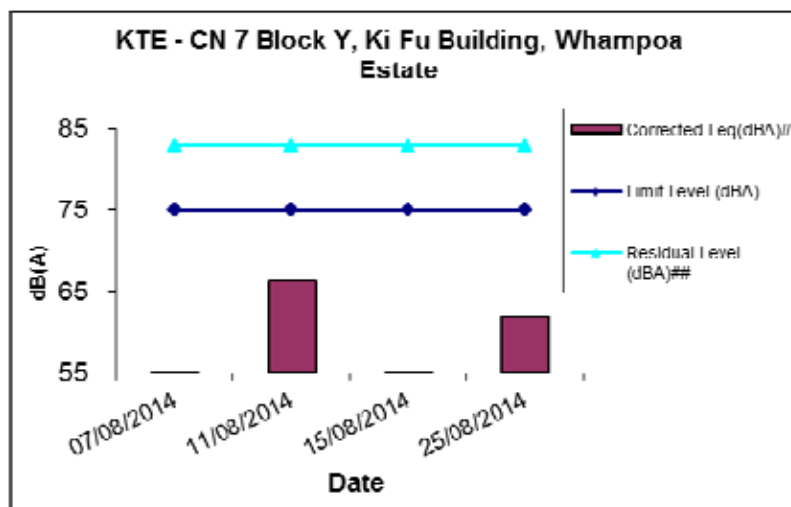
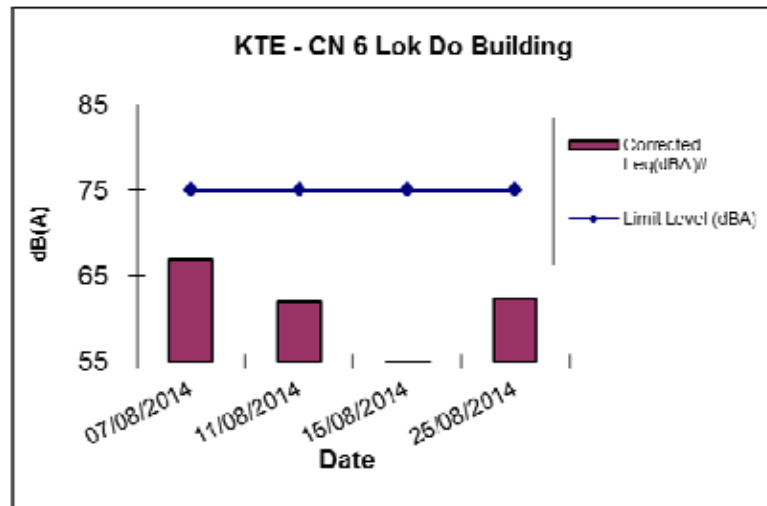
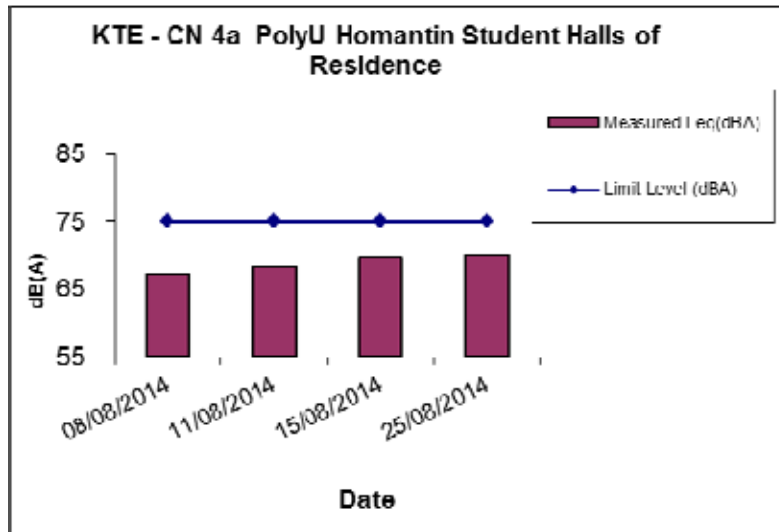

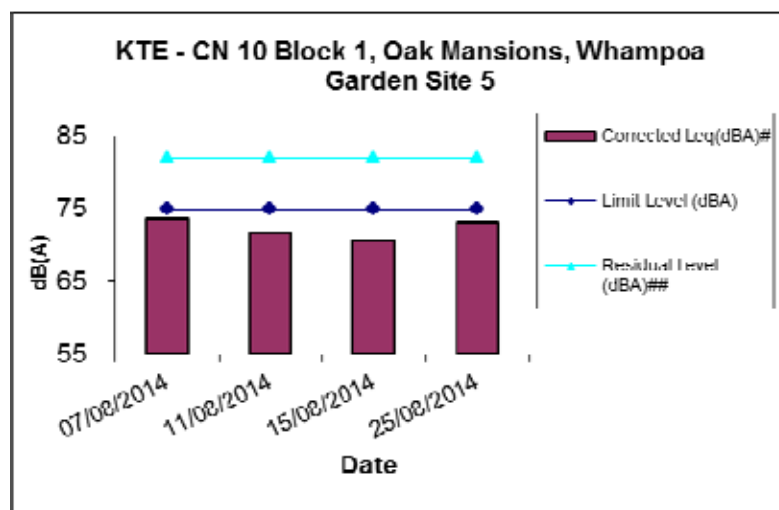
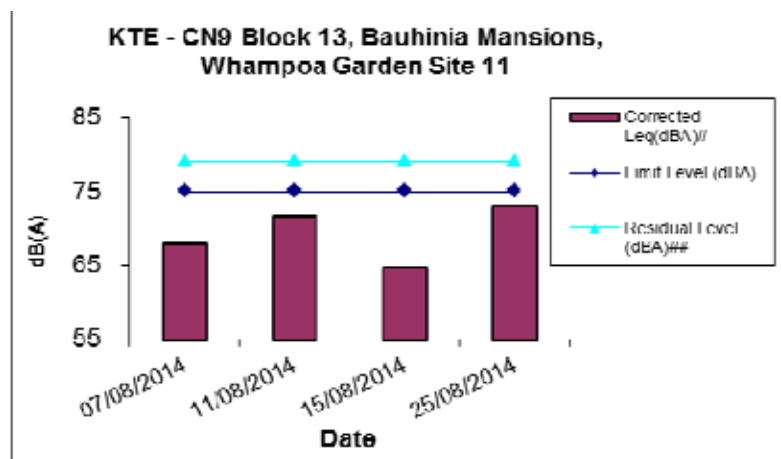
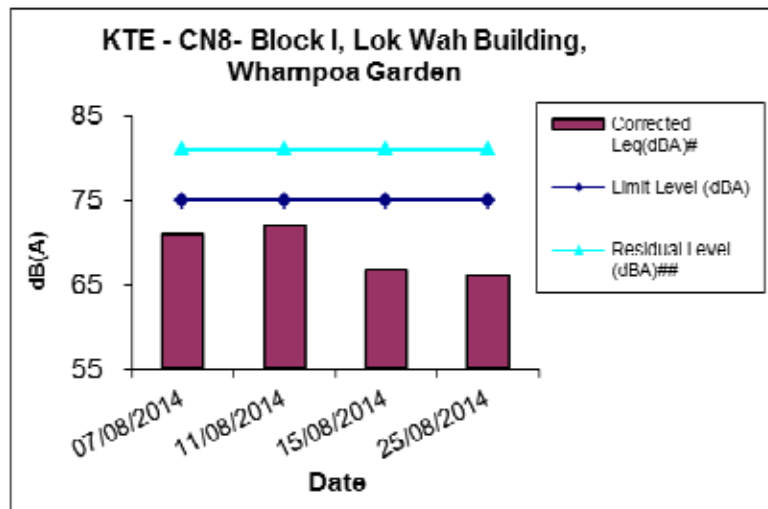

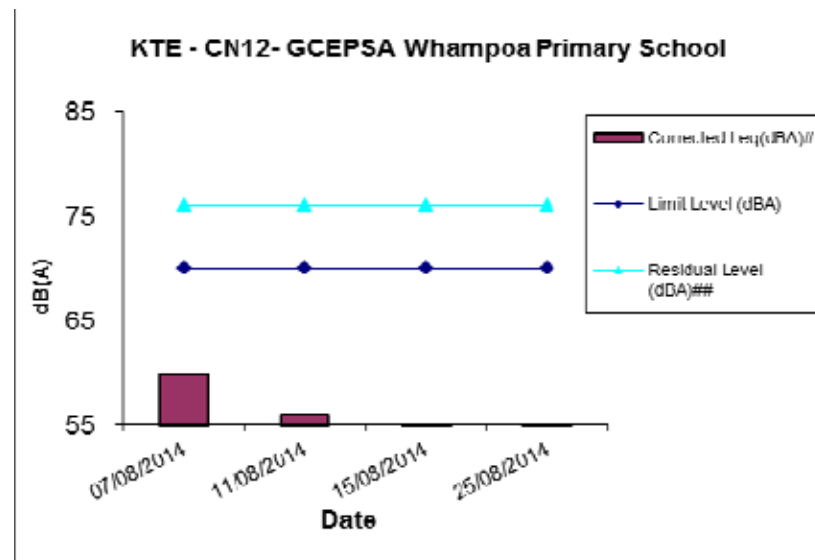
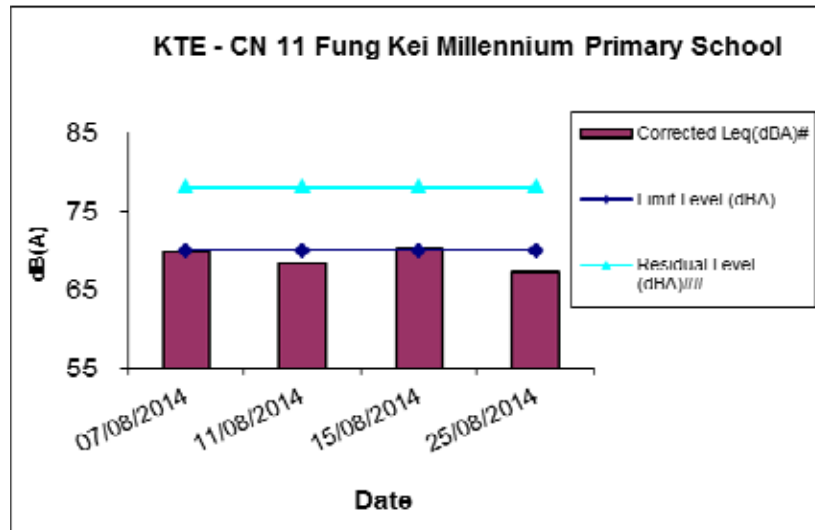

As some of the measured Leq is lower than the baseline level, correction against baseline level cannot be applied.

Appendix G

Monitoring Schedule for the Present and Next Reporting Period

Dust Monitoring Schedule for August 2014				
CD1a	CD2a	CD3a	CD4a	CD5
8/8/2014	8/8/2014	4/8/2014	8/8/2014	8/8/2014
14/8/2014	14/8/2014	9/8/2014	14/8/2014	14/8/2014
20/8/2014	20/8/2014	15/8/2014	20/8/2014	20/8/2014
28/8/2014	28/8/2014	21/8/2014	26/8/2014	26/8/2014
		27/8/2014		
Tentative Dust Monitoring Schedule for September 2014				
CD1a	CD2a	CD3a	CD4a	CD5
2/9/2014	2/9/2014	3/9/2014	2/9/2014	2/9/2014
10/9/2014	10/9/2014	8/9/2014	10/9/2014	10/9/2014
16/9/2014	16/9/2014	16/9/2014	16/9/2014	16/9/2014
22/9/2014	22/9/2014	23/9/2014	22/9/2014	22/9/2014
30/9/2014	30/9/2014	29/9/2014	30/9/2014	30/9/2014

Noise Monitoring Schedule for August 2014										
CN1	CN2	CN3a	CN4a	CN6	CN7	CN8	CN9	CN10	CN11	CN12
7/8/2014	7/8/2014	8/8/2014	8/8/2014	7/8/2014	5/8/2014	5/8/2014	5/8/2014	5/8/2014	5/8/2014	5/8/2014
11/8/2014	11/8/2014	11/8/2014	11/8/2014	11/8/2014	11/8/2014	11/8/2014	11/8/2014	11/8/2014	11/8/2014	11/8/2014
15/8/2014	15/8/2014	15/8/2014	15/8/2014	15/8/2014	21/8/2014	21/8/2014	21/8/2014	21/8/2014	21/8/2014	21/8/2014
25/8/2014	25/8/2014	25/8/2014	25/8/2014	25/8/2014	28/8/2014	28/8/2014	28/8/2014	28/8/2014	28/8/2014	28/8/2014
Tentative Noise Monitoring Schedule for September 2014										
CN1	CN2	CN3a	CN4a	CN6	CN7	CN8	CN9	CN10	CN11	CN12
2/9/2014	2/9/2014	2/9/2014	2/9/2014	2/9/2014	4/9/2014	4/9/2014	4/9/2014	4/9/2014	4/9/2014	4/9/2014
10/9/2014	10/9/2014	10/9/2014	10/9/2014	10/9/2014	11/9/2014	11/9/2014	11/9/2014	11/9/2014	11/9/2014	11/9/2014
16/9/2014	16/9/2014	16/9/2014	16/9/2014	16/9/2014	18/9/2014	18/9/2014	18/9/2014	18/9/2014	18/9/2014	18/9/2014
24/9/2014	24/9/2014	24/9/2014	24/9/2014	24/9/2014	25/9/2014	25/9/2014	25/9/2014	25/9/2014	25/9/2014	25/9/2014

Remarks:

The schedule may be changed due to unforeseen circumstances (adverse weather, etc)