

Hong Kong Offshore LNG Terminal - Works associated with the subsea gas pipeline for Lamma Power Station (LPS) and the associated Gas Receiving Station (GRS) in LPS

Location Plan

3 February 2021

Project No.: 0505354

Document details	
Document title	Hong Kong Offshore LNG Terminal - Works associated with the subsea gas pipeline for Lamma Power Station (LPS) and the associated Gas Receiving Station (GRS) in LPS
Document subtitle	Location Plan
Project No.	0505354
Date	3 February 2021
Version	3
Author	RY
Client Name	The Hongkong Electric Company Limited

Document history

	Revision	Author	Reviewed by	ERM approval to issue		Comments
				Name	Date	
	0	RY	RC	JN	15/7/2020	N/A
	1	RY	RC	JN	7/12/2020	N/A
	2	RY	RC	JN	19/1/2021	N/A
	3	RY	RC	JN	3/2/2021	N/A

Signature Page

3 February 2021

Hong Kong Offshore LNG Terminal - Works associated with the subsea gas pipeline for Lamma Power Station (LPS) and the associated Gas Receiving Station (GRS) in LPS

Location Plan

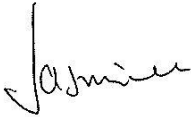

Dr Jasmine Ng
Partner

ERM-Hong Kong, Limited
2509, 25/F One Harbourfront
18 Tak Fung Street
Hung Hom
Kowloon
Hong Kong

© Copyright 2021 by ERM Worldwide Group Ltd and/or its affiliates ("ERM").
All rights reserved. No part of this work may be reproduced or transmitted in any form,
or by any means, without the prior written permission of ERM.

Hong Kong Offshore LNG Terminal – Works associated with the subsea gas pipeline for Lamma Power Station (LPS) and the associated Gas Receiving Station (GRS) in LPS

Environmental Certification Sheet

FEP-02/558/2018/A

Reference Document/Plan

Document/ Plan to be Certified/ Verified:	Location Plan
Date of Report:	3 February 2021
Date received by ET:	3 February 2021
Date received by IEC:	5 February 2021

Reference EP Requirement

EP Condition:	Condition No. 2.6 of FEP-02/558/2018/A
Content:	<i>Location Plan</i>
<p>The Permit Holder shall, no later than 1 month before the commencement of construction of the Project, deposit with the Director 3 hard copies and 1 electronic copy of a location plan of the Project with a scale of 1:1000 or other appropriate scale as agreed with the Director. The location plan shall include but not limited to the details of the works areas and boundaries, vertical and horizontal alignments of the subsea pipeline, and locations of the key environmental mitigation measures. The Project shall be constructed in accordance with the information as contained in the deposited location plan.</p>	

ET Certification

I hereby certify that the above referenced document/ plan complies with the above referenced condition of FEP-02/558/2018/A.	
Mr Raymond Chow, Environmental Team Leader:	 Date: 16 February 2021

IEC Verification

I hereby verify that the above referenced document/ plan complies with the above referenced condition of FEP-02/558/2018/A.	
Mr Arthur Lo, Independent Environmental Checker:	 Date: 16 February 2021

CONTENTS

1. INTRODUCTION	1
1.1 Background.....	1
1.2 Objectives of the Location Plan	1
2. INDICATIVE WORKS AREAS AND BOUNDARIES OF THE PROJECT	3
2.1 The LPS Pipeline.....	3
2.2 The GRS.....	3
3. LOCATIONS OF KEY ENVIRONMENTAL MITIGATION MEASURES.....	4

Annexes

Annex A	Overall LPS Pipeline Route
Annex B	Indicative Works Areas for the LPS Pipeline
Annex C	Vertical and Horizontal Alignments of the LPS Pipeline
Annex D	Indicative Works Areas for the GRS at LPS

List of Tables

Table 3.1	Locations of Key Environmental Mitigation Measures	4
Table 3.2	Summary of Dredging and Jetting Operation and Mitigation Measure for Pipeline Construction Works.....	6

List of Figures

Figure 1.1	Indicative Location of Key Project Components
------------	---

1. INTRODUCTION

1.1 Background

To support the increased use of natural gas in Hong Kong from 2020 onwards, Castle Peak Power Company Limited (CAPCO) and The Hongkong Electric Company, Limited (HK Electric) have identified that the development of an offshore liquefied natural gas (LNG) receiving terminal in Hong Kong using Floating Storage and Regasification Unit (FSRU) technology ('the Hong Kong Offshore LNG Terminal Project') presents a viable additional gas supply option that will provide energy security through access to competitive gas supplies from world markets. The Hong Kong Offshore LNG Terminal Project will involve the construction and operation of an offshore LNG import facility to be located in the southern waters of Hong Kong, a double berth jetty, and subsea pipelines that connect to the gas receiving stations (GRS) at the Black Point Power Station (BPPS) and the Lamma Power Station (LPS).

The Environmental Impact Assessment (EIA) Report for the Hong Kong Offshore LNG Terminal Project was submitted to the Environmental Protection Department (EPD) of the Hong Kong Special Administrative Region Government in May 2018. The EIA Report (EIAO Register No. AEIAR-218/2018) was approved by EPD and the associated Environmental Permit (EP) (EP-558/2018) was issued in October 2018. An application for Further Environmental Permits (FEP) were made on 24 December 2019 to demarcate the works between the different parties. The following FEPs were issued on 17 January 2020:

- the double berth jetty at LNG Terminal under the Hong Kong LNG Terminal Limited, joint venture between CAPCO and HK Electric (FEP-01/558/2018/A) ⁽¹⁾;
- the subsea gas pipeline for the BPPS and the associated GRS in the BPPS under CAPCO (FEP-03/558/2018/A) ⁽²⁾; and
- the subsea gas pipeline for the LPS and the associated GRS in the LPS under HK Electric (FEP-02/558/2018/A) ⁽³⁾.

The location plan for the works associated with the subsea gas pipeline for LPS and the associated GRS in LPS ('the Project') is provided in **Figure 1.1**.

1.2 Objectives of the Location Plan

This *Location Plan* for the Project has been prepared in accordance with Condition 2.6 of the Further Environmental Permit FEP-02/558/2018/A.

FEP No. FEP-02/558/2018/A, Condition 2.6:

"The Permit Holder shall, no later than 1 month before the commencement of construction of the Project, deposit with the Director 3 hard copies and 1 electronic copy of a location plan of the Project with a scale of 1:1000 or other appropriate scale as agreed with the Director. The location plan shall include but not limited to the details of the works areas and boundaries, vertical and horizontal alignments of the subsea pipeline, and locations of the key environmental mitigation measures. The Project shall be constructed in accordance with the information as contained in the deposited location plan."

The key objectives of this Location Plan are to:

- (1) Application for variation of an environmental permit for FEP-01/558/2018 was undertaken and the latest FEP (FEP-01/558/2018/A) was issued on 6 November 2020.
- (2) Application for variation of an environmental permit for FEP-03/558/2018 was undertaken and the latest FEP (FEP-03/558/2018/A) was issued on 22 January 2021.
- (3) Application for variation of an environmental permit for FEP-02/558/2018 was undertaken and the latest FEP (FEP-02/558/2018/A) was issued on 22 December 2020.

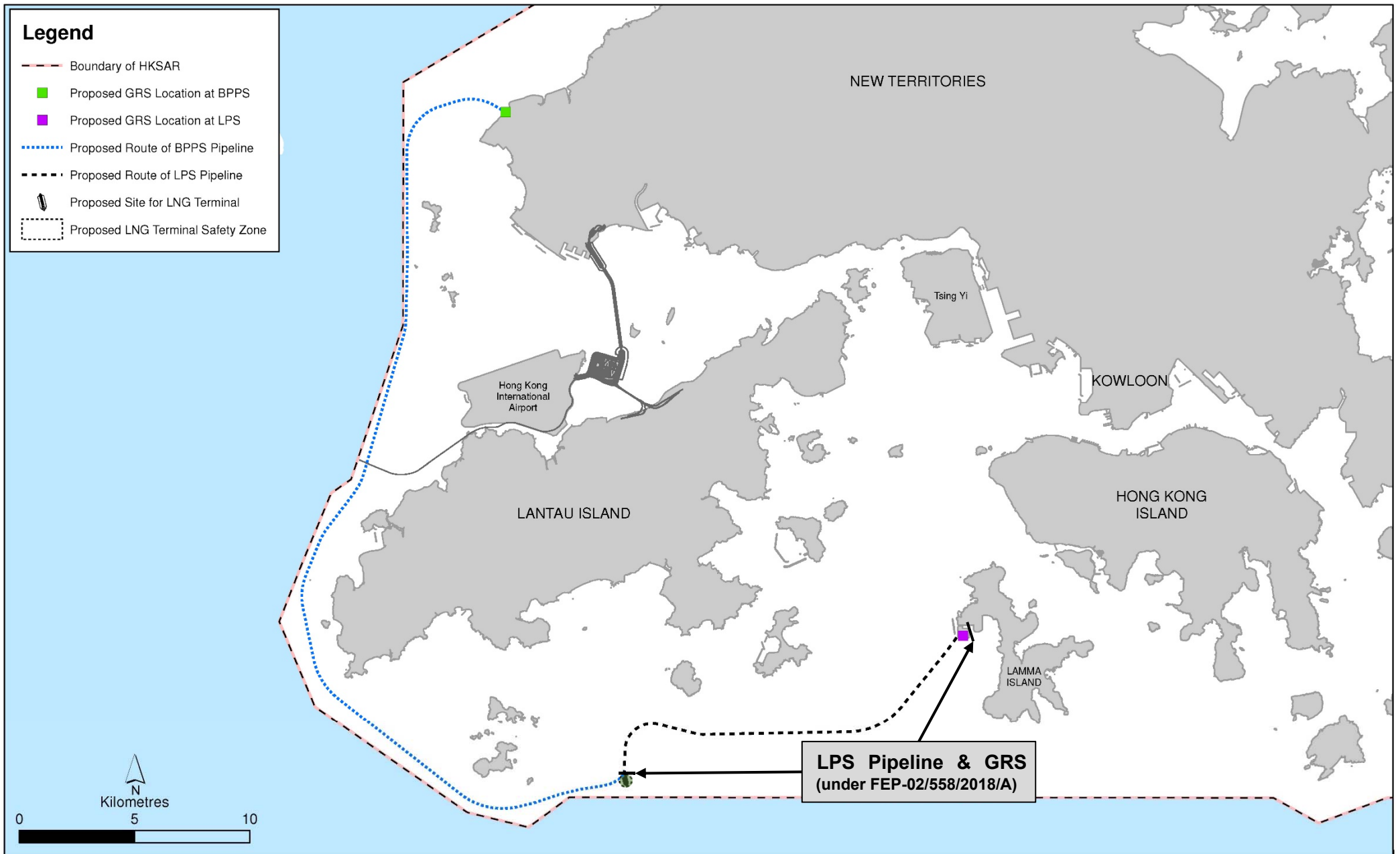

Figure 1.1

Indicative Location of Key Project Components

- include the details of the works areas and boundaries, vertical and horizontal alignments of the subsea pipeline; and
- include locations of the key environmental mitigation measures.

The Location Plan will be reviewed and updated as appropriate, throughout the course of the construction works to confirm that it remains current with the latest detailed information and works practice.

2. INDICATIVE WORKS AREAS AND BOUNDARIES OF THE PROJECT

The Project contains the following key facilities:

- A subsea gas pipeline connecting the LNG Terminal with the LPS ('the LPS Pipeline'); and
- A GRS located entirely within the LPS.

2.1 The LPS Pipeline

The proposed LPS Pipeline will connect the LNG Terminal with the GRS at the LPS and is approximately 20 inches (20") in diameter and 18km in length. It is located entirely within HKSAR waters.

The LPS Pipeline route departs the LNG Terminal and heads north passing between the eastern boundary of the proposed South Lantau Marine Park (SLMP) and the western boundary of the Sediment Disposal Area.

Thereafter, the LPS Pipeline route turns eastwards and runs between the southern boundary of the South Cheung Chau Traffic Separation Scheme and the northern boundary of the Sediment Disposal Area.

The LPS Pipeline then continues to run eastwards and, en route, crosses two (2) existing subsea cables to the north of the HK Electric proposed wind farm in southwest Lamma.

It is proposed that the LPS Pipeline will tie-in to an existing pipeline located approximately 1km from the LPS landfall point adjacent to the existing Dapeng Pipeline.

The overall LPS Pipeline route is shown in **Annex A**. The indicative works areas for the LPS Pipeline, taking into account the installation vessels and supporting vessels (e.g. tug boat, cargo barge, flat top barge for storage, etc.), silt curtain installation ⁽⁴⁾, anchor arrangement and vessel logistics, are shown in **Annex B**. The works areas will not encroach onto the proposed South Lantau Marine Park. The vertical and horizontal alignments of the LPS Pipeline are shown in **Annex C**.

2.2 The GRS

The proposed location for the new GRS at the LPS is within the existing boundary of the LPS southern platform extension site. The land area has been used for material storage, and there are no other facilities or utilities within this land area. The indicative works area is shown in **Annex D**.

(4) The location of double layer silt curtain is indicative and the actual extent of the double layer silt curtain is dependent on the location of the jetting works, following the requirements stated in Table A.2 of the Updated EM&A Manual. The length of the double layer silt curtain deployed at the active jetting location will be determined considering the findings of the EIA Report, the potential impact to existing marine traffic for review by the Marine Department and the performance of the pilot test upon agreement with the Environmental Team and the Independent Environmental Checker.

3. LOCATIONS OF KEY ENVIRONMENTAL MITIGATION MEASURES

The recommended key environmental mitigation measures and the associated locations specified, as appropriate, are summarised in **Table 3.1**. Other mitigation measures relevant to the Project will also be implemented in accordance with the Implementation Schedule detailed in Annex A of the Updated EM&A Manual.

Table 3.1 Locations of Key Environmental Mitigation Measures

Location	Key Environmental Mitigation Measures
Marine waters in Hong Kong	<ul style="list-style-type: none"> <li data-bbox="472 566 1382 734">■ No working vessels for construction of the Project shall enter into, transit through, stop over or anchor within the existing marine parks including Southwest Lantau Marine Park and the proposed South Lantau Marine Park, unless otherwise agreed by the Director of Environmental Protection. <li data-bbox="472 757 1382 1025">■ The vessel operators of this Project will be required to use predefined and regular routes (that do not encroach into existing and proposed marine parks), make use of designated fairways to access the works areas, and would avoid traversing sensitive habitats such as existing and proposed marine parks. Predefined and regular routes will become known to Finless Porpoise (FP) and Chinese White Dolphin (CWD) using these waters. This measure will further serve to minimise disturbance to marine mammals due to vessel movements. <li data-bbox="472 1048 1382 1216">■ The working vessels for construction of the Project shall not be operated at a speed higher than 10 knots when moving within the areas frequented by CWD or FP, including the waters near Sha Chau and Lung Kwu Chau Marine Park, the waters at the west of Lantau Island and the waters between Soko Islands and Shek Kwu Chau. <li data-bbox="472 1238 1382 1406">■ The working vessels shall be equipped with tracking devices to record their operating speeds and marine travel routes during construction of the Project. The records shall be submitted weekly to the Environmental Team (ET) Leader and Independent Environmental Checker (IEC) for review of the acceptability of operating speeds and marine travel routes. <li data-bbox="472 1429 1062 1462">■ All vessels must have a clean ballast system. <li data-bbox="472 1485 1366 1541">■ All vessels should be well maintained and inspected before use to limit any potential discharges to the marine environment.
Existing marine parks, proposed South Lantau Marine Park	<ul style="list-style-type: none"> <li data-bbox="472 1563 1382 1630">■ Any anchoring/ anchor spread requirements during Project construction will avoid encroachment into the existing and proposed marine parks. <li data-bbox="472 1653 1382 1749">■ No stopping over or anchoring activity of vessels related to the Project should be conducted within existing and proposed marine parks even before, during and after typhoon.
LPS Pipeline between the LNG Terminal and South of Shek Kwu Chau (LPS KP0.0 – KP5.0)	<ul style="list-style-type: none"> <li data-bbox="472 1771 1382 1839">■ Pipeline dredging/ jetting works will be restricted to a daily maximum of 12 hours with daylight (0700 – 1900) operations.

Location	Key Environmental Mitigation Measures
LPS Pipeline between Double Berth Jetty and South of Shek Kwu Chau (LPS KP0.1 – KP5.0)	<ul style="list-style-type: none"> ▪ Double Layer silt curtain shall be deployed at the eastern boundary of the proposed South Lantau Marine Park.
Areas with dredging / jetting works	<ul style="list-style-type: none"> ▪ Adoption of appropriate dredging and jetting rate, plant numbers and silt curtains at the plant and water sensitive receivers in accordance with Table A.2 of the Updated EM&A Manual, reprovided in Table 3.2 below. ▪ No more than one jetting machine will be used for construction of the subsea gas pipeline. ▪ Silt curtain shall be formed and installed in such a way that tidal rise and fall are accommodated, with the silt curtain always extending from the surface to the bottom of the water column and held with anchor blocks. ▪ Silt curtain shall be inspected regularly to check that they are moored and marked to avoid danger to marine traffic, and any damage to the silt curtain shall be repaired promptly. ▪ Dredged marine mud will be disposed of in a gazetted marine disposal area in accordance with the Dumping at Sea Ordinance (DASO) permit conditions. ▪ Dredgers will maintain adequate clearance between vessels and the seabed at all states of the tide and reduce operations speed to ensure that excessive turbidity is not generated by turbulence from vessel movement or propeller wash. ▪ Marine works shall not cause foam, oil, grease, litter or other objectionable matter to be present in the water within and adjacent to the works site. Wastewater from potentially contaminated area on working vessels should be minimised and controlled. These kinds of wastewater should be brought back to port and discharged at appropriate collection and treatment system. ▪ No soil waste is allowed to be disposed overboard. ▪ Implementation of a marine mammal exclusion zone of not less than 250 m radius from the dredging and jetting works. ▪ No dredging or jetting works will be carried until the marine mammal exclusion zone is confirmed by an experienced marine mammal observer as clear of marine mammals for 30 minutes continuously. ▪ Use of passive acoustic monitoring device shall be explored to assist the marine mammal observer to monitor and detect the marine mammals.
GRS at LPS	<ul style="list-style-type: none"> ▪ Silt removal facilities such as silt traps or sedimentation facilities will be provided to remove silt particles from runoff to meet the requirements of the TM standard under the WPCO. All drainage facilities and erosion and sediment control structures will be inspected on a regular basis and maintained to confirm proper and efficient operation at all times and particularly during rainstorms. Deposited silt and grit will be removed regularly.

Location	Key Environmental Mitigation Measures
	<ul style="list-style-type: none"> ▪ Earthworks to form the final surfaces will be followed up with surface protection and drainage works to prevent erosion caused by rainstorms. ▪ Oil interceptors will be provided in the drainage system where necessary and regularly emptied to prevent the release of oil and grease into the storm water drainage system after accidental spillages. ▪ Temporary and permanent drainage pipes and culverts provided to facilitate runoff discharge, if any, will be adequately designed for the controlled release of storm flows. ▪ The temporary diverted drainage, if any, will be reinstated to the original condition when the construction work has finished or when the temporary diversion is no longer required. ▪ Appropriate numbers of portable (temporary) toilets shall be provided by a licensed contractor to serve the construction workers over the construction site to prevent direct disposal of sewage into the water environment. No onsite discharge from these chemical (temporary) toilets would be allowed. ▪ Pre-construction and construction period for the GRS at the LPS should be reduced as far as practical to lower visual impact.

Table 3.2 Summary of Dredging and Jetting Operation and Mitigation Measure for Pipeline Construction Works

Work Location	Types and No. of Plant Involved	Allowed Maximum Work Rate	Silt Curtain at Plants	Silt Curtain at Water Sensitive Receivers (WSRs)	Other Measures
Existing pipeline end section east of LPS pipeline (LPS KP17.3-17.4)	1 MFE Machine	1,000m day ⁻¹ for 24 hours each day	Yes	Not required	
West Lamma Channel (LPS KP14.5-17.4)	1 Jetting Machine	1,000m day ⁻¹ for 24 hours each day	Yes	Not required	
South of Shek Kwu Chau to West Lamma Channel (LPS KP5.0-14.5)	1 Jetting Machine	7,000m day ⁻¹ for 24 hours each day	Yes	Not required	
Double Berth Jetty to South of Shek Kwu Chau (LPS KP0.1-5.0)	1 Jetting Machine	720m day ⁻¹ for 24 hours each day	Yes	Two layers at Eastern Boundary of the Proposed South Lantau Marine Park (KP0.1-5.0)	Daily maximum of 12 hours with daylight (0700 – 1900)

HONG KONG OFFSHORE LNG TERMINAL - WORKS ASSOCIATED WITH THE
 SUBSEA GAS PIPELINE FOR LAMMA POWER STATION (LPS) AND THE
 ASSOCIATED GAS RECEIVING STATION (GRS) IN LPS
 Location Plan

Work Location	Types and No. of Plant Involved	Allowed Maximum Work Rate	Silt Curtain at Plants	Silt Curtain at Water Sensitive Receivers (WSRs)	Other Measures
Pipeline Riser (LPS KP0.0-0.1)	1 Grab Dredger	8,000m ³ day ⁻¹ for 24 hours each day	Yes	Not required	Daily maximum of 12 hours with daylight (0700 – 1900)

ANNEX A

OVERALL LPS PIPELINE ROUTE

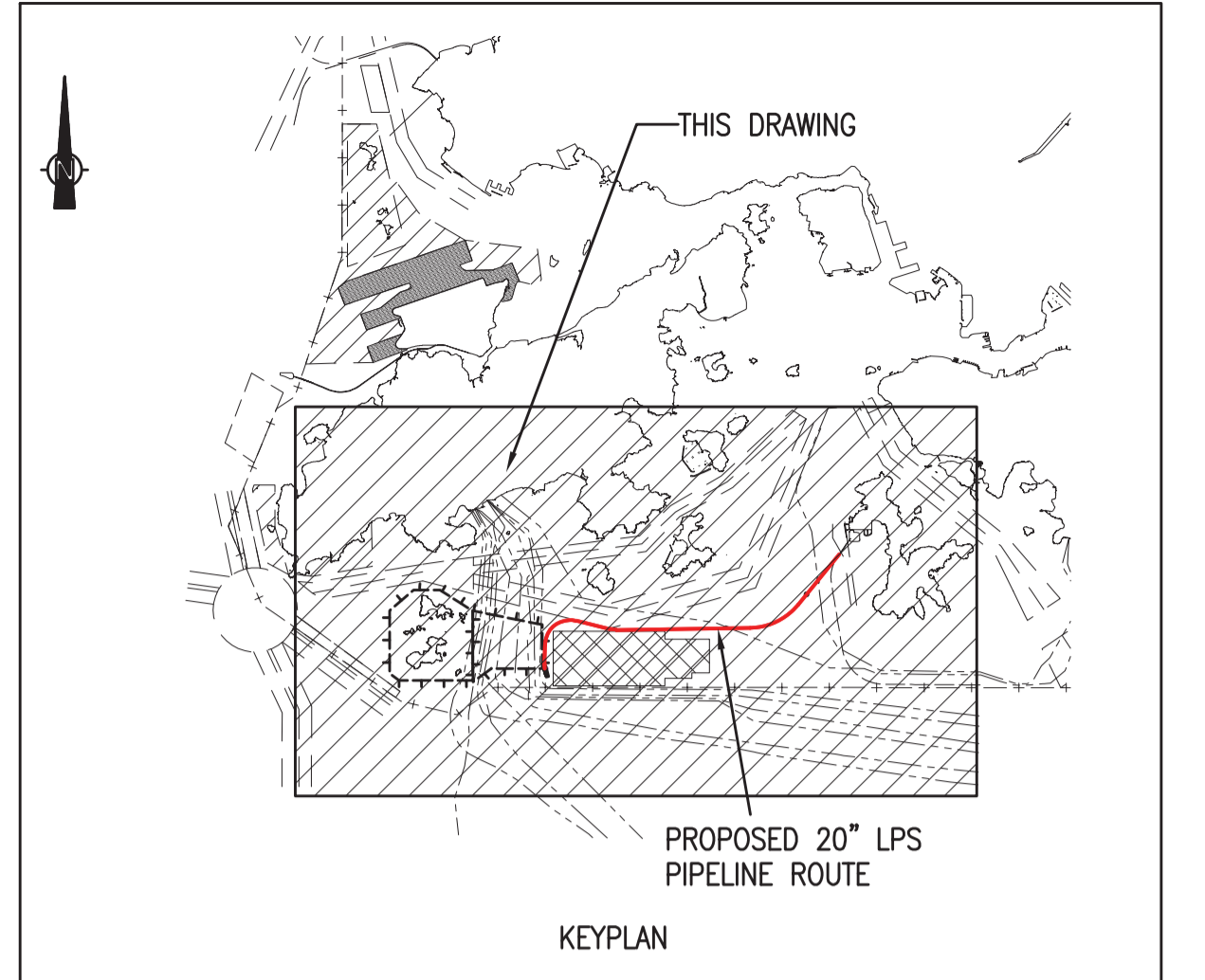
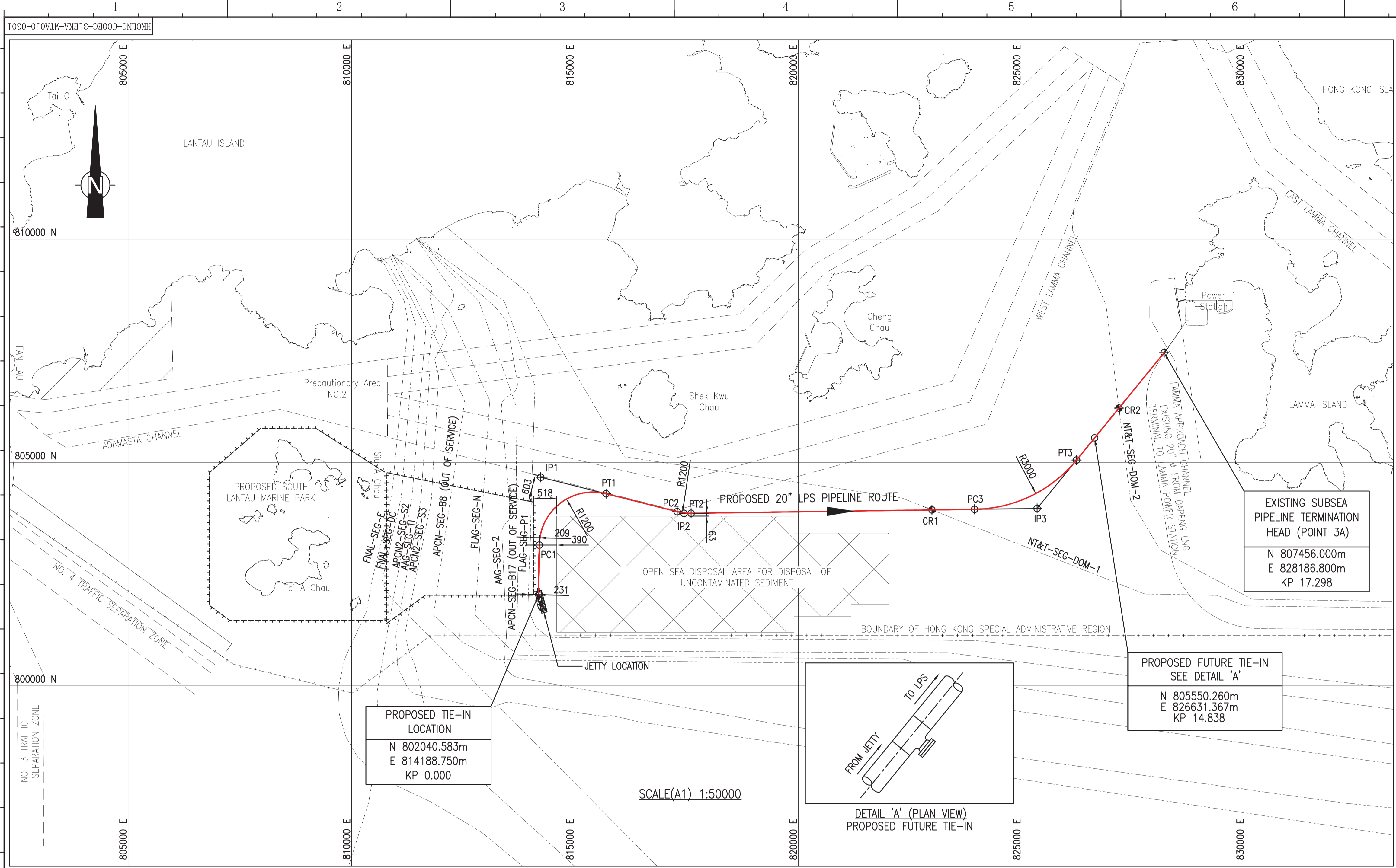

- NOTES**
- ALL COORDINATES AND DIMENSIONS ARE IN METRES. THE COORDINATES ARE REFERENCED TO HONG KONG 1980 GRID SYSTEM.
 - THE PIPELINE AND SPOOL TIE-IN POINT IS SUBJECT TO SITE ADJUSTMENT IN LONGITUDINAL DIRECTION BASED ON ACTUAL PIPELINE INITIATION HEAD LAYDOWN LOCATION. HOWEVER, THE PIPELINE START POINT (I.E. KPO) SHALL BE TAKEN AS THE END OF THE FIRST PIPE JOINT ON SEABED IN CONNECTION WITH THE RISER BOTTOM BEND.
 - FOR FSRO GAZETTE AREA ALONG THE PROPOSED PIPELINE ROUTE, REFER TO LPS PIPELINE ALIGNMENT SHEETS.
 - CROSSING LOCATION SHOWN IN TABLE IS BASED ON CABLE DETECTED DATA FROM EGS SURVEY, HK253019.
 - PIPELINE BEARINGS ARE MEASURED CLOCKWISE FROM GRID NORTH TO PIPELINE FLOW DIRECTION.

- LEGEND**
- PROPOSED 20" LPS PIPELINE ROUTE
 - - - SHIPPING CHANNEL
 - · - · - · - BOUNDARY OF HONG KONG SPECIAL ADMINISTRATIVE REGION
 - - - - - EXISTING SUBMARINE CABLE (BURIED)
 - - - - - EXISTING PIPELINE
 - ⊗ OPEN SEA DISPOSAL AREA
- | | | | |
|-----|---------------------|------|--|
| CR | CROSSING | PC | POINT OF CURVATURE |
| E | EASTING | PT | POINT OF TANGENCY |
| IP | INTERSECTION POINT | R | RADIUS |
| LPS | LAMMA POWER STATION | FSRO | FORESHORE AND SEA-BED (RECLAMATIONS) ORDINANCE |
| KP | KILOMETRE POST | | |
| MD | MOORING DOLPHIN | | |
| N | NORTHING | | |

PROPOSED TIE-IN LOCATION
 N 802040.583m
 E 814188.750m
 KP 0.000

EXISTING SUBSEA PIPELINE TERMINATION HEAD (POINT 3A)
 N 807456.000m
 E 828186.800m
 KP 17.298

PROPOSED FUTURE TIE-IN SEE DETAIL 'A'
 N 805550.260m
 E 826631.367m
 KP 14.838

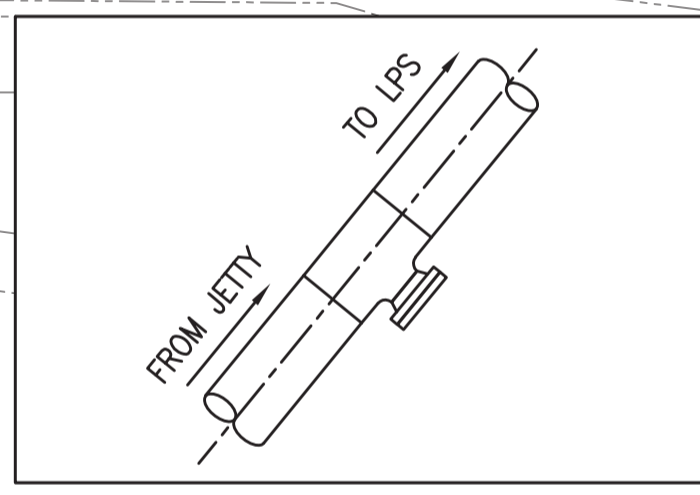

SCALE(A1) 1:50000

PROPOSED 20" LPS PIPELINE ROUTE				
PIPELINE ROUTE DATA				
LOCATION	KP	CO-ORDINATES (m) - HONG KONG 1980 GRID SYSTEM		TURNING RADIUS (m)
		EASTING (E)	NORTHING (N)	
RISER/SPOOL TIE-IN POINT	-0.012	814188.616	802028.498	-
PIPELINE TIE-IN POINT	0.000	814188.750	802040.583	00°38'02"
PC1	1.110	814201.028	803150.086	-
IP1	-	814217.880	804672.935	1200
PT1	3.278	815694.540	804300.340	-
PC2	4.920	817287.129	803898.494	-
IP2	-	817439.937	803859.937	1200
PT2	5.234	817597.518	803862.144	-
PC3	11.581	823944.028	803951.025	-
IP3	-	825342.077	803970.604	3000
PT3	14.198	826226.164	805053.800	-
EXISTING SUBSEA PIPELINE TERMINATION HEAD (POINT 3A)	17.298	828186.800	807456.000	-

PROPOSED 20" LPS PIPELINE ROUTE					
CROSSING LOCATIONS					
CROSSING NO.	CROSSING DESCRIPTION	CROSSING ANGLE (°)	KP	CO-ORDINATES (m) - HONG KONG 1980 GRID SYSTEM	
				EASTING (E)	NORTHING (N)
CR1	NT&T-SEG-DOM-1	22	10.627	822989.895	803937.662
CR2	NT&T-SEG-DOM-2	46	15.700	827176.006	806217.561

HK245317	EGS ALIGNMENT CHARTS
HKOLNG-COOEC-31EKA-MTA010-0306	LPS PIPELINE TIE-IN TO EXISTING 20" PRE-INSTALLED PIPELINE DRAWING
HKOLNG-COOEC-31EKA-MTA010-0304	LPS PIPELINE JETTY APPROACH DRAWING
HKOLNG-COOEC-31EKA-MTA010-0302	LPS PIPELINE ALIGNMENT DRAWING
DWG. NO.	DRAWING TITLE

REFERENCE DOCUMENTS					
REV.	DATE	DESCRIPTION	BY	CHK.	APP'D
0	25NOV20	Issued for Construction	CuiSM	LiuW	YuZB
D	28OCT20	Issued for Design	CuiSM	LiuW	YuZB
C1	25JUL20	Issued for Review	CuiSM	LiuW	YuZB
C	25MAR20	Issued for Review	CuiSM	LiuW	YuZB
B	12MAR20	Internally Approved	CuiSM	LiuW	YuZB
A	03MAR20	Discipline Internal Check	CuiSM	LiuW	YuZB

CLIENT			JOB No.	20ZB-DD02
SIGNATURE	DATE	PROJECT:	HONG KONG OFFSHORE LNG TERMINAL PROJECT	
DRAWN	CuiSM	25NOV20	PACKAGE C-C/N 19-63003 LPS PIPELINE	
DESIGNED	CuiSM	25NOV20	DRAWING TITLE:	
CHECKED	LiuW	25NOV20	LPS PIPELINE	
REVIEWED	YuZB	25NOV20	OVERALL ROUTE LAYOUT DRAWING	
EXAMINED	XiongHR	25NOV20	DWG No.	HKOLNG-COOEC-31EKA-MTA010-0301
APPROVED	SunGM	25NOV20	REV.	0

ANNEX B

INDICATIVE WORKS AREAS FOR THE LPS PIPELINE

DESIGN	
DISCIPLINE	
SIGNATURE	
DATE	

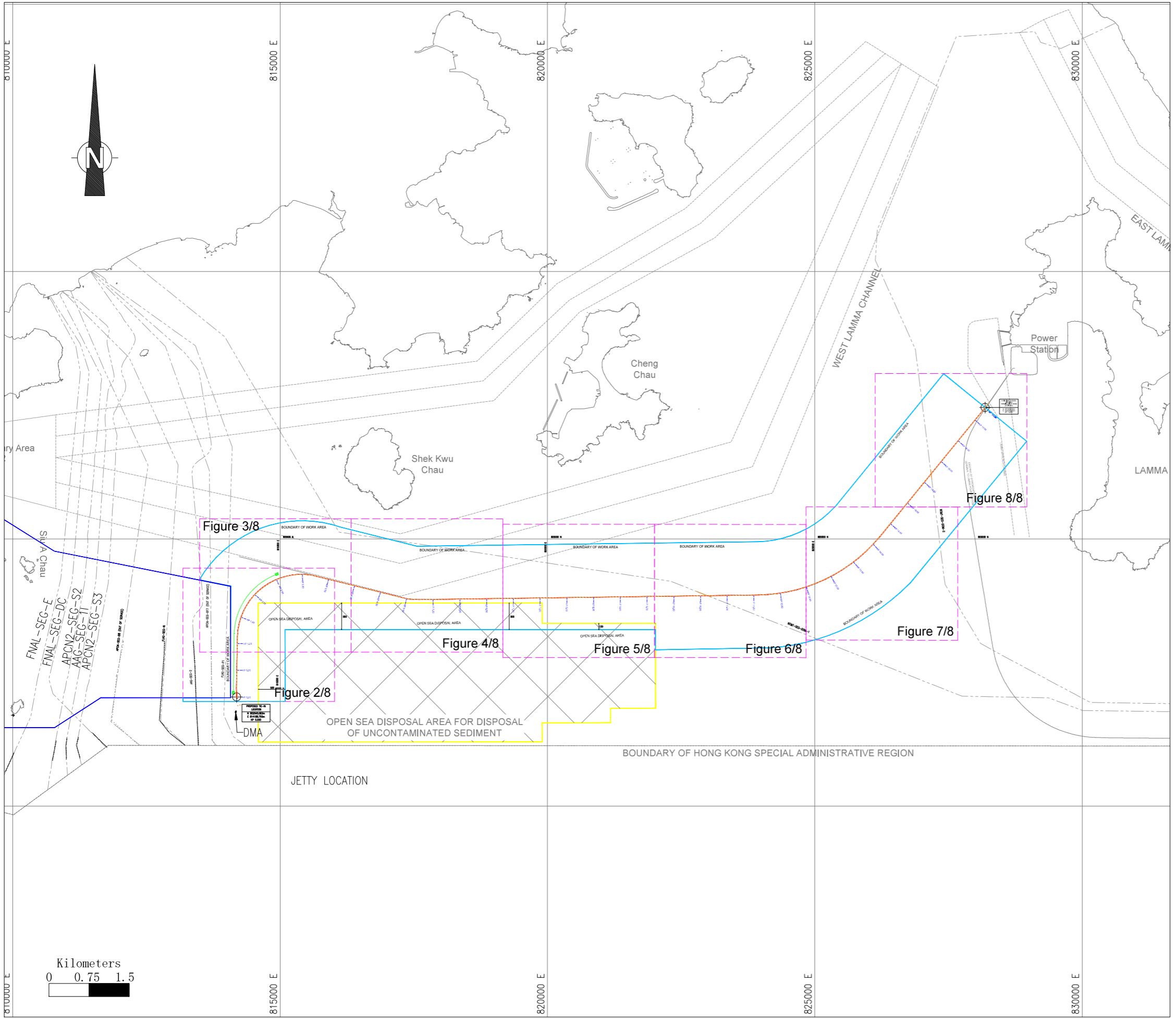

LEGEND:

- Boundary of work area
- - - Double Silt Curtain
- LPS Pipeline
- Boundary of Open Sea Disposal Area
- Boundary of proposed South Lantau Marine Park
- Drawing Cut Line

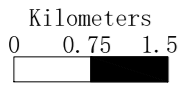

PROPOSED 20" LPS PIPELINE ROUTE

REVISION	No.	DATE	DESCRIPTION	BY	REV' W.	EXAM.	CLP
D1	04JAN21		Issued for Review	Liuwang	XuHB	Zhangjie	
D	29OCT20		Issued for Review	Liuwang	XuHB	Zhangjie	
C1	04JUN20		Issued for Review	Liuwang	XuHB	YeHB	
C	30APR20		Issued for Review	Liuwang	XuHB	YeHB	

CLIENT	香港電氣	Offshore Oil Engineering Co.,Ltd		
SIGNATORY	SIGNATURE	DATE	PROJECT TITLE:	JOB No.
DRAWN	Liuwang	04JAN21	HONG KONG OFFSHORE LNG TERMINAL PROJECT	20ZB-DD2
DESIGNED	Liuwang	04JAN21	Works associated with the subsea gas pipeline for Lamma Power Station and the associated Gas Receiving Station in LPS	CERTIF. No.
CHECKED	XuHB	04JAN21	(Further Environment Permit No.FEP-02/558/2018/A)	A112002816
REVIEWED	Zhangjie	04JAN21	Drawing Title:	SCALE (A3)
EXAMINED			LPS Pipeline Work Area Sketch	1:75000
APPROVED			DWG No. HKOLNG-CO0EC-31EKA-CTC020-5014(1/8)	REV. D1

DESIGN	
DISCIPLINE	
SIGNATURE	
DATE	

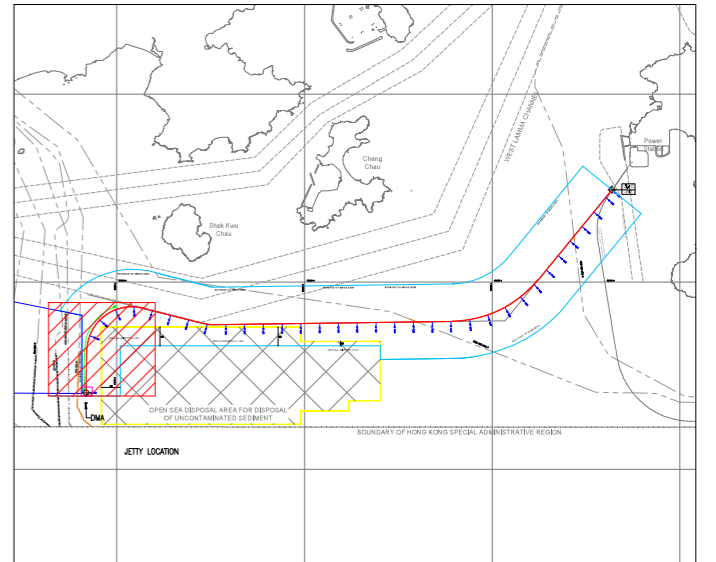
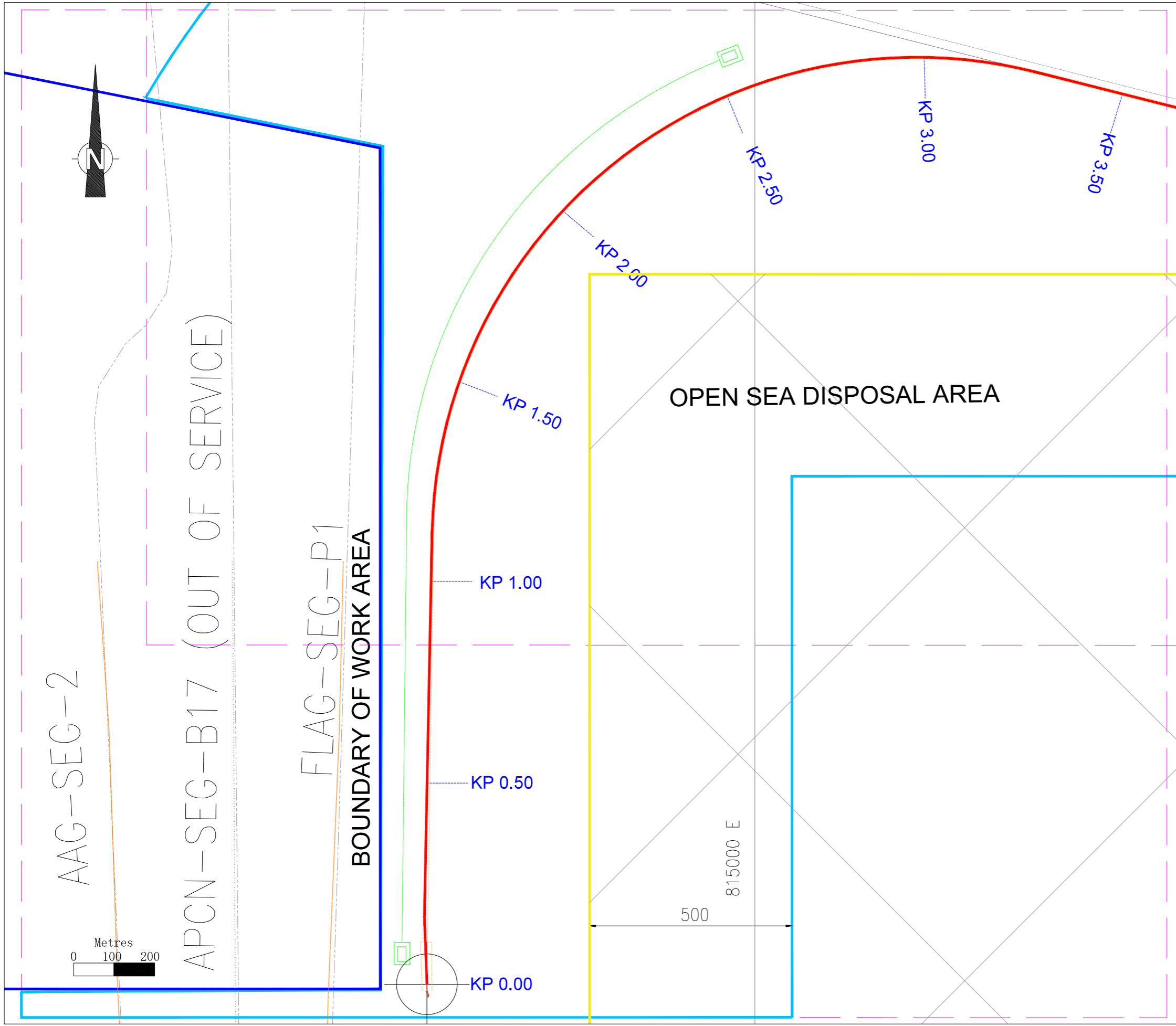

KP	WGS84		HK80	
	LATITUDE	LONGITUDE	E	N
KP0.0	22° 9.392' N	113° 57.769' E	814188	802040
KP0.5	22° 9.663' N	113° 57.768' E	814188	802524
KP1.0	22° 9.934' N	113° 57.774' E	814198	803024
KP1.5	22° 10.201' N	113° 57.811' E	814263	803518
KP2.0	22° 10.433' N	113° 57.957' E	814514	803946
KP2.5	22° 10.590' N	113° 58.192' E	814918	804235
KP3.0	22° 10.646' N	113° 58.474' E	815404	804337
KP3.5	22° 10.599' N	113° 58.760' E	815894	804250

LEGEND:

- Boundary of work area
- Boundary of Open Sea Disposal Area
- Double Silt Curtain
- LPS Pipeline
- Boundary of Proposed South Lantau Marine Park
- Silt Curtain Holding Barge
- Drawing Cut Line

Note:
 The cage type silt curtain will adopt along the LPS pipeline during dredging (KP 0-0.1) and jetting work (KP 0.1-17.30).
 The length of the double layer silt curtain deployed at the active jetting location will be determined considering the findings of the EIA Report, the potential impact to existing marine traffic for review by the Marine Department and the performance of the pilot test upon agreement with the Environmental Team and the Independent Environmental Checker.

REVISION	No.	DATE	DESCRIPTION	BY	REV' W.	EXAM.	CLP
D1	04JAN21		Issued for Review	Liuwang	XuHB	Zhangjie	
D	29OCT20		Issued for Review	Liuwang	XuHB	Zhangjie	
C1	04JUN20		Issued for Review	Liuwang	XuHB	YeHB	
C	30APR20		Issued for Review	Liuwang	XuHB	YeHB	

CLIENT	港電 HK Electric	Offshore Oil Engineering Co., Ltd		
SIGNATORY	SIGNATURE	DATE	PROJECT TITLE:	JOB. No.
DRAWN	Liuwang	04JAN21	HONG KONG OFFSHORE LNG TERMINAL PROJECT	20ZB-DD2
DESIGNED	Liuwang	04JAN21	Works associated with the subsea gas pipeline for Lamma Power Station and the associated Gas Receiving Station in LPS	CERTIF. No.
CHECKED	XuHB	04JAN21	Further Environment Permit No.FEP-02/558/2018/A)	A112002816
REVIEWED	Zhangjie	04JAN21	Drawing Title:	SCALE (A3)
EXAMINED			LPS Pipeline Work Area Sketch	1:10000
APPROVED			DWG No. HKOLNG-CO0EC-31EKA-CTC020-5014(2/8)	REV. D1

PROPOSED 20" LPS PIPELINE ROUTE

DESIGN	
DESCRIPTION	
SIGNATURE	
DATE	

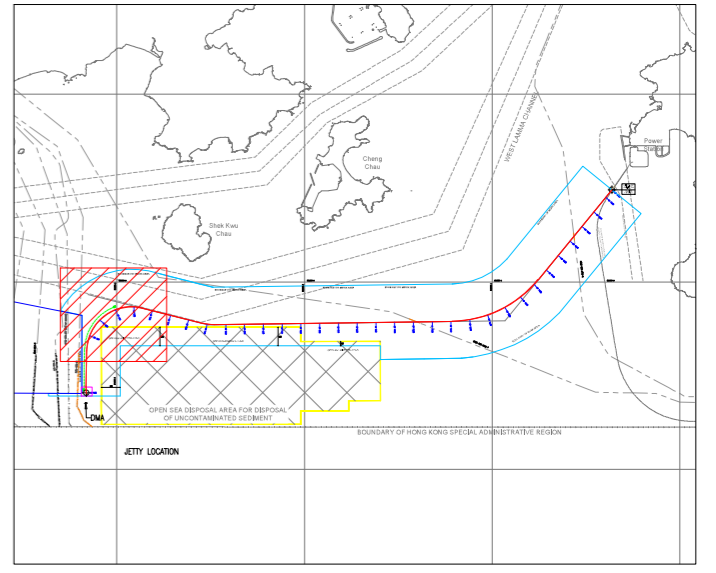
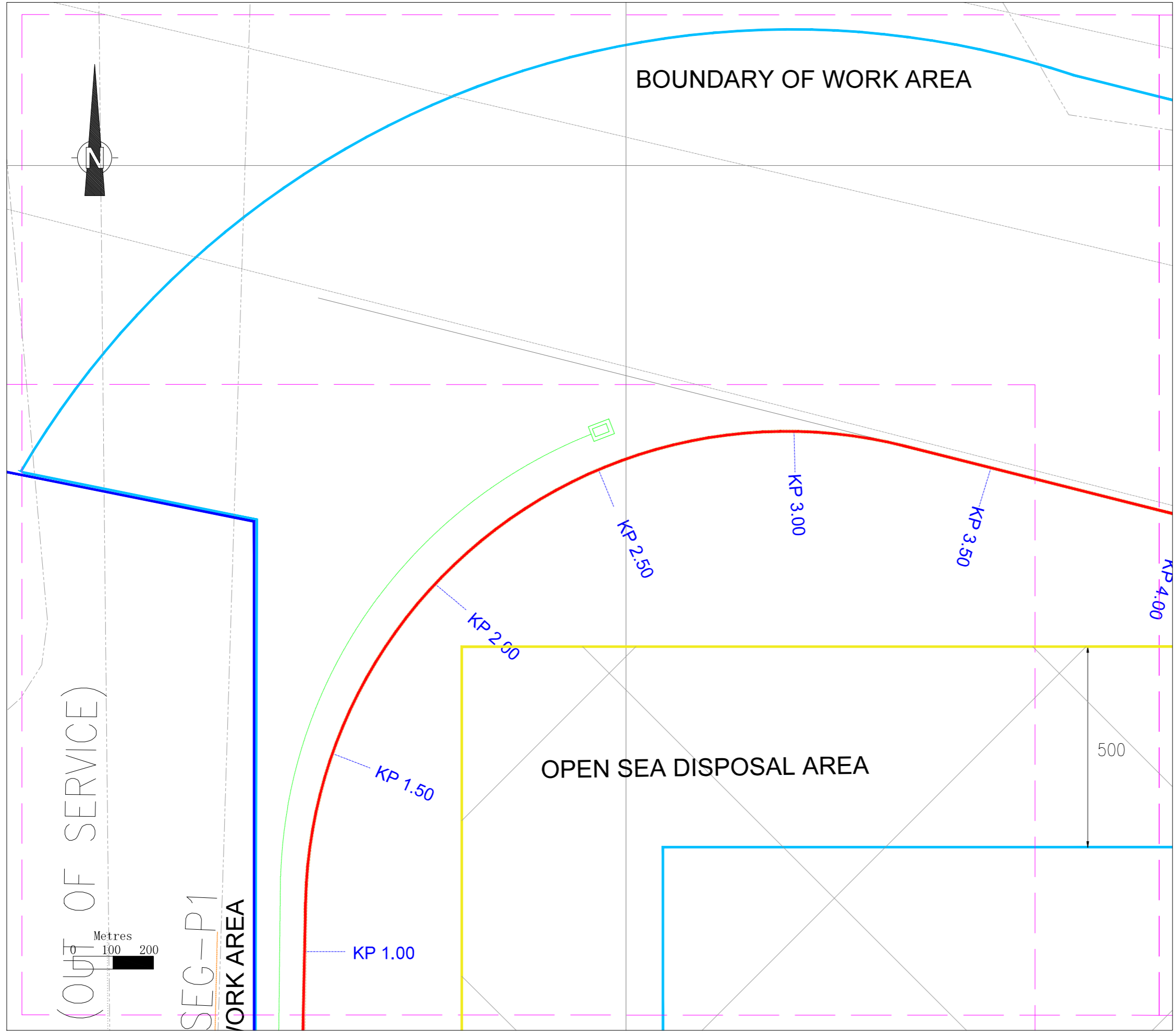

KP	WGS84		HK80	
	LATITUDE	LONGITUDE	E	N
KP1.0	22° 9.934' N	113° 57.774' E	814198	803024
KP1.5	22° 10.201' N	113° 57.811' E	814263	803518
KP2.0	22° 10.433' N	113° 57.957' E	814514	803946
KP2.5	22° 10.590' N	113° 58.192' E	814918	804235
KP3.0	22° 10.646' N	113° 58.474' E	815404	804337
KP3.5	22° 10.599' N	113° 58.760' E	815894	804250
KP4.0	22° 10.533' N	113° 59.042' E	816379	804128

LEGEND:

- Boundary of work area
- Boundary of Open Sea Disposal Area
- Double Silt Curtain
- LPS Pipeline
- Boundary of Proposed South Lantau Marine Park
- Silt Curtain Holding Barge
- Drawing Cut Line

Note:

The cage type silt curtain will adopt along the LPS pipeline during dredging (KP 0-0.1) and jetting work (KP 0.1-17.30).

The length of the double layer silt curtain deployed at the active jetting location will be determined considering the findings of the EIA Report, the potential impact to existing marine traffic for review by the Marine Department and the performance of the pilot test upon agreement with the Environmental Team and the Independent Environmental Checker.

REVISION	No.	DATE	DESCRIPTION	BY	REV' W.	EXAM.	CLP
D1	04JAN21		Issued for Review	Liuwang	XuHB	Zhangjie	
D	29OCT20		Issued for Review	Liuwang	XuHB	Zhangjie	
C1	04JUN20		Issued for Review	Liuwang	XuHB	YeHB	
C	30APR20		Issued for Review	Liuwang	XuHB	YeHB	

CLIENT	HK Electric	Offshore Oil Engineering Co.,Ltd		
SIGNATORY	SIGNATURE	DATE	PROJECT TITLE:	JOB No.
DRAWN	Liuwang	04JAN21	HONG KONG OFFSHORE LNG TERMINAL PROJECT	20ZB-DD2
DESIGNED	Liuwang	04JAN21	Works associated with the subsea gas pipeline for Lamma Power Station and the associated Gas Receiving Station in LPS	CERTIF. No.
CHECKED	XuHB	04JAN21	(Further Environment Permit No. FEP-02/558/2018/A)	A112002816
REVIEWED	Zhangjie	04JAN21	Drawing Title:	SCALE (A3)
EXAMINED			LPS Pipeline Work Area Sketch	1:10000
APPROVED			DWG No. HKOLNG-COEEC-31EKA-CTC020-5014 (3/8)	REV. D1

DESIGN	
DISCIPLINE	
SIGNATURE	
DATE	

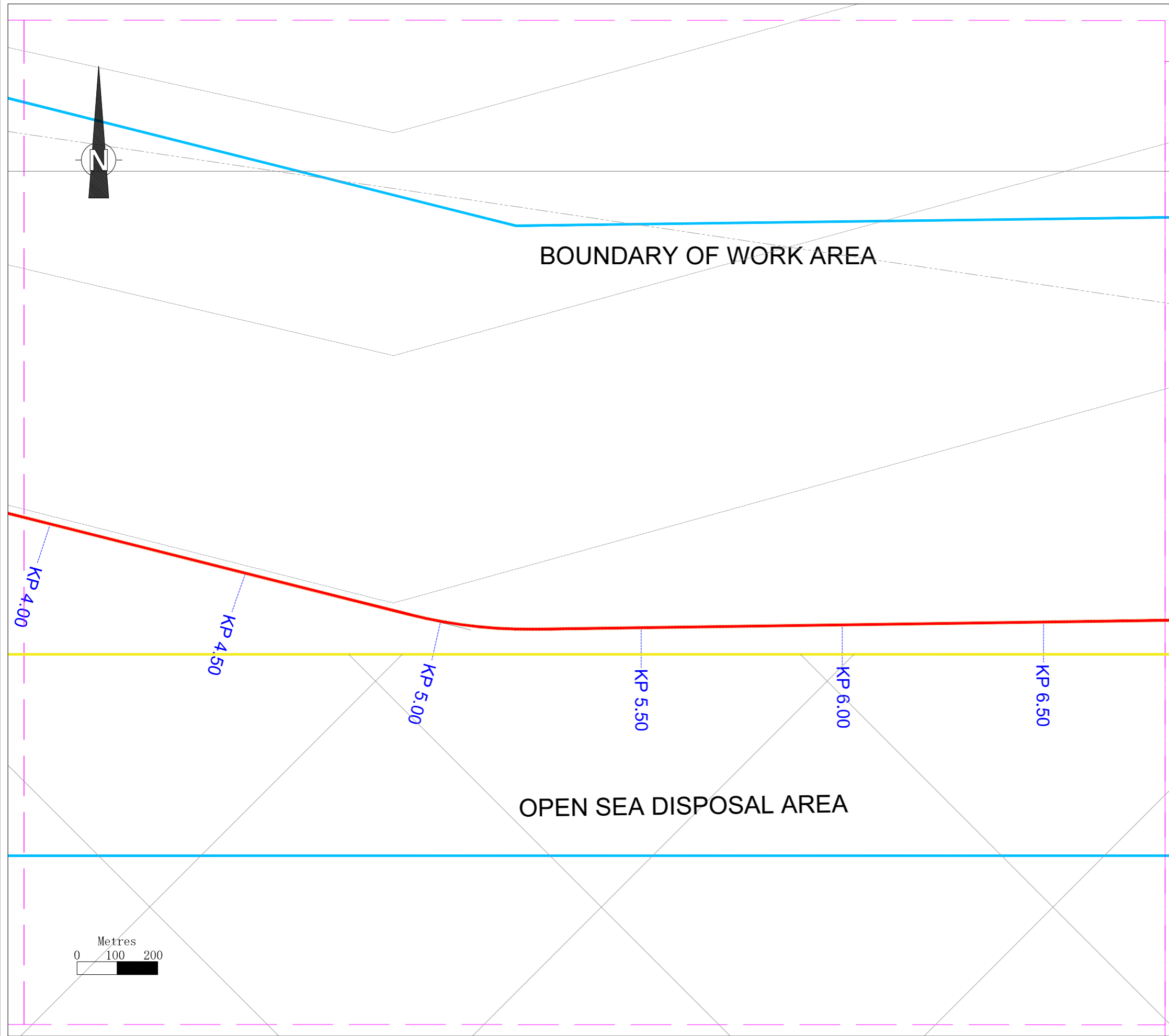

PROPOSED 20" LPS PIPELINE ROUTE

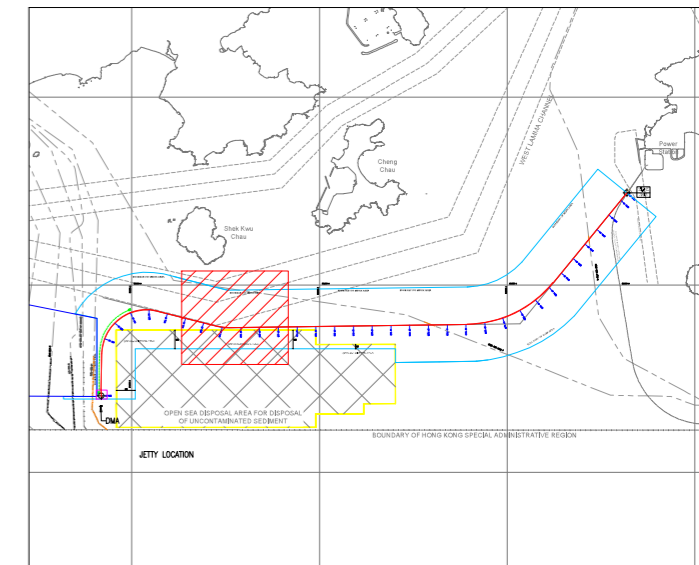

KP	WGS84		HK80	
	LATITUDE	LONGITUDE	E	N
KP4.0	22° 10.533' N	113° 59.042' E	816379	804128
KP4.5	22° 10.467' N	113° 59.324' E	816864	804005
KP5.0	22° 10.402' N	113° 59.606' E	817349	803885
KP5.5	22° 10.392' N	113° 59.896' E	817848	803866
KP6.0	22° 10.396' N	114° 0.187' E	818348	803873
KP6.5	22° 10.400' N	114° 0.478' E	818847	803880

LEGEND:

- Boundary of work area
- Boundary of Open Sea Disposal Area
- LPS Pipeline
- - - Drawing Cut Line

Note:
The cage type silt curtain will adopt along the LPS pipeline during dredging (KP 0-0.1) and jetting work (KP 0.1-17.30).

REVISION	No.	DATE	DESCRIPTION	BY	REV' W.	EXAM.	CLP
D1	04JAN21		Issued for Review	Liuwang	XuHB	Zhangjie	
D	29OCT20		Issued for Review	Liuwang	XuHB	Zhangjie	
C1	04JUN20		Issued for Review	Liuwang	XuHB	YeHB	
C	30APR20		Issued for Review	Liuwang	XuHB	YeHB	

CLIENT	HK Electric	Offshore Oil Engineering Co.,Ltd		
SIGNATORY	SIGNATURE	DATE	PROJECT TITLE:	JOB No.
DRAWN	Liuwang	04JAN21	HONG KONG OFFSHORE LNG TERMINAL PROJECT	20ZB-DD2
DESIGNED	Liuwang	04JAN21	Works associated with the subsea gas pipeline for Lamma Power Station and the associated Gas Receiving Station in LPS	CERTIF. No.
CHECKED	XuHB	04JAN21	(Further Environment Permit No.FEP-02/558/2018/A)	A112002816
REVIEWED	Zhangjie	04JAN21	Drawing Title:	SCALE (A3)
EXAMINED			LPS Pipeline Work Area Sketch	1:10000
APPROVED			DWG No. HKOLNG-CO0EC-31EKA-CTC020-5014(4/8)	REV. D1

DESIGN	
DESCRIPTION	
SIGNATURE	
DATE	

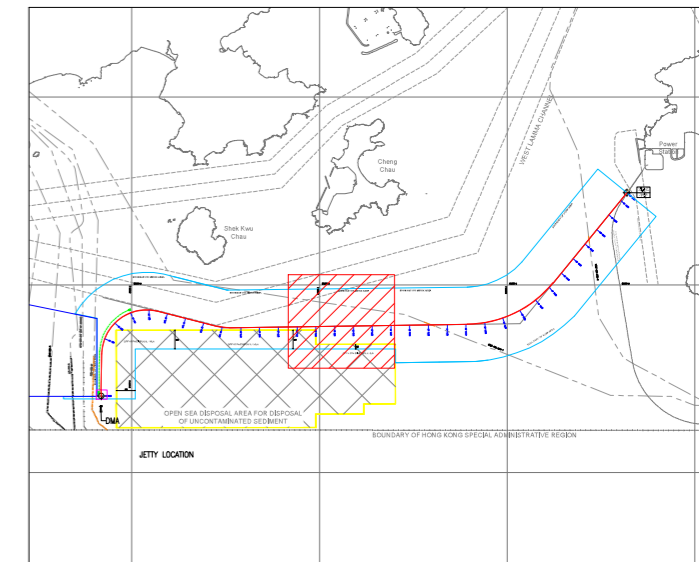
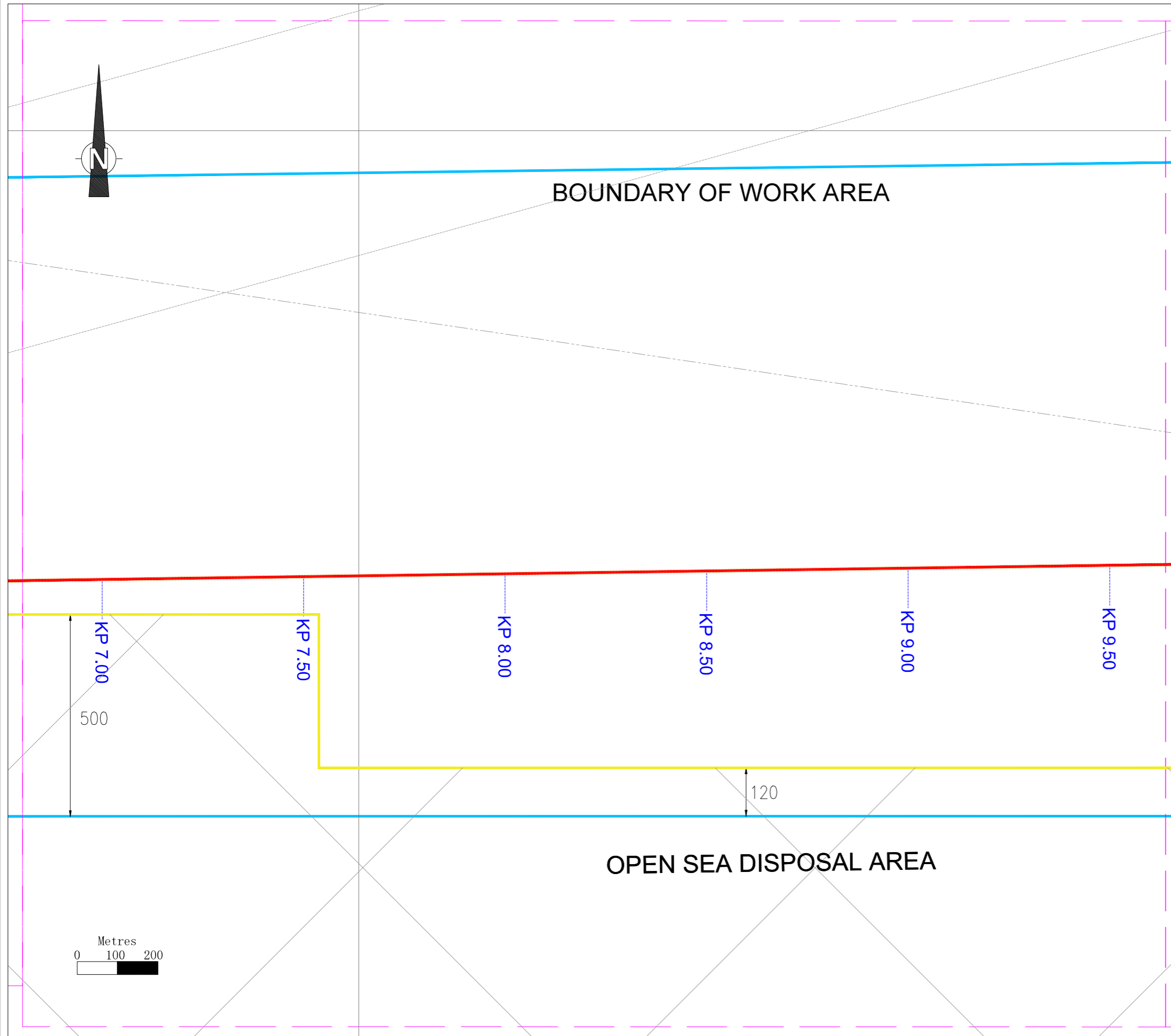

KP	WGS84		HK80	
	LATITUDE	LONGITUDE	E	N
KP7.0	22° 10.404' N	114° 0.769' E	819347	803887
KP7.5	22° 10.408' N	114° 1.060' E	819847	803894
KP8.0	22° 10.413' N	114° 1.351' E	820347	803901
KP8.5	22° 10.417' N	114° 1.641' E	820847	803908
KP9.0	22° 10.421' N	114° 1.932' E	821347	803915
KP9.5	22° 10.425' N	114° 2.223' E	821847	803922

LEGEND:

- Boundary of work area
- Boundary of Open Sea Disposal Area
- LPS Pipeline
- - - Drawing Cut Line

Note:
The cage type silt curtain will adopt along the LPS pipeline during dredging (KP 0-0.1) and jetting work (KP 0.1-17.30).

REVISION	No.	DATE	DESCRIPTION	BY	REV' W.	EXAM.	CLP
D1	04JAN21		Issued for Review	Liuwang	XuHB	Zhangjie	
D	29OCT20		Issued for Review	Liuwang	XuHB	Zhangjie	
C1	04JUN20		Issued for Review	Liuwang	XuHB	YeHB	
C	30APR20		Issued for Review	Liuwang	XuHB	YeHB	

CLIENT	香港電氣 HK Electric	Offshore Oil Engineering Co., Ltd		
SIGNATORY	SIGNATURE	DATE	PROJECT TITLE:	JOB. No.
DRAWN	Liuwang	04JAN21	HONG KONG OFFSHORE LNG TERMINAL PROJECT	20ZB-DD2
DESIGNED	Liuwang	04JAN21	Works associated with the subsea gas pipeline for Lamma Power Station and the associated Gas Receiving Station in LPS	CERTIF. No.
CHECKED	XuHB	04JAN21	(Further Environment Permit No. FEP-02/558/2018/A)	A112002816
REVIEWED	Zhangjie	04JAN21	Drawing Title:	SCALE (A3)
EXAMINED			LPS Pipeline Work Area Sketch	1:10000
APPROVED			DWG No. HKOLNG-CO0EC-31EKA-CTC020-5014(5/8)	REV. D1

PROPOSED 20" LPS PIPELINE ROUTE

DESIGN	
DESCRIPTION	
SIGNATURE	
DATE	

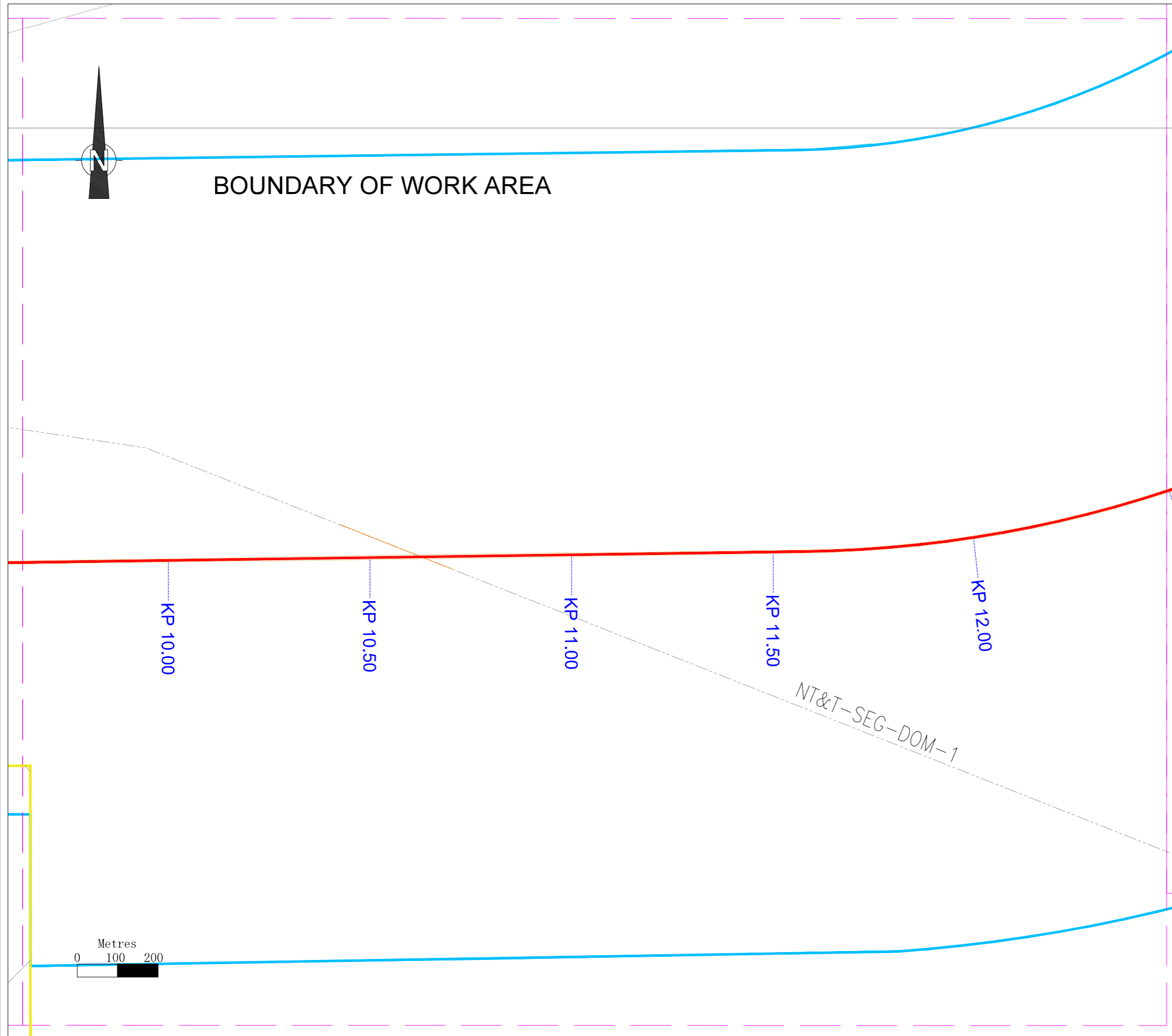

PROPOSED 20" LPS PIPELINE ROUTE

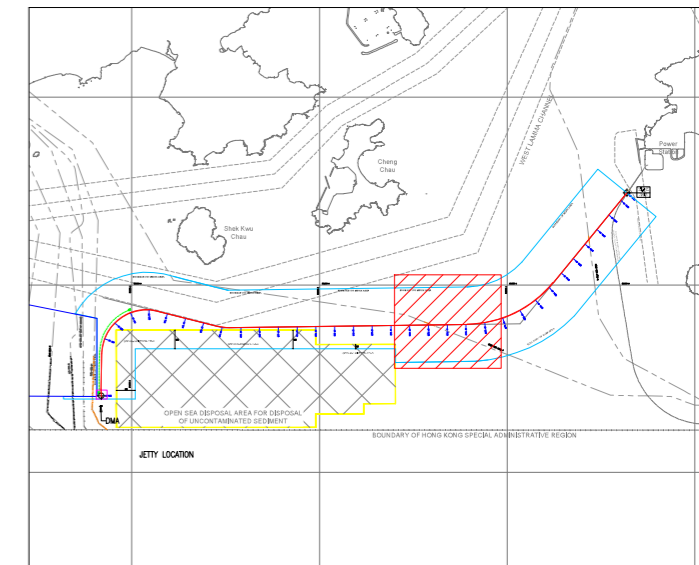

KP	WGS84		HK80	
	LATITUDE	LONGITUDE	E	N
KP10.0	22° 10.429' N	114° 2.514' E	822347	803929
KP10.5	22° 10.433' N	114° 2.805' E	822847	803936
KP11.0	22° 10.437' N	114° 3.096' E	823347	803943
KP11.5	22° 10.441' N	114° 3.386' E	823847	803950
KP12.0	22° 10.459' N	114° 3.676' E	824345	803984

LEGEND:

- Boundary of work area
- Boundary of Open Sea Disposal Area
- LPS Pipeline
- - - Drawing Cut Line

Note:
The cage type silt curtain will adopt along the LPS pipeline during dredging (KP 0-0.1) and jetting work (KP 0.1-17.30).

REVISION	No.	DATE	DESCRIPTION	BY	REV' W.	EXAM.	CLP
D1	04JAN21		Issued for Review	Liuwang	XuHB	Zhangjie	
D	29OCT20		Issued for Review	Liuwang	XuHB	Zhangjie	
C1	04JUN20		Issued for Review	Liuwang	XuHB	YeHB	
C	30APR20		Issued for Review	Liuwang	XuHB	YeHB	

CLIENT			Offshore Oil Engineering Co.,Ltd
SIGNATORY	SIGNATURE	DATE	PROJECT TITLE:
DRAWN	Liuwang	04JAN21	HONG KONG OFFSHORE LNG TERMINAL PROJECT
DESIGNED	Liuwang	04JAN21	Works associated with the subsea gas pipeline for Lamma Power Station and the associated Gas Receiving Station in LPS
CHECKED	XuHB	04JAN21	(Further Environment Permit No.FEP-02/558/2018/A)
REVIEWED	Zhangjie	04JAN21	Drawing Title:
EXAMINED			LPS Pipeline Work Area Sketch
APPROVED			DWG No. HKOLNG-CO0EC-31EKA-CTC020-5014(6/8)
			JOB. No. 20ZB-DD2
			CERTIF. No. A112002816
			SCALE (A3) 1:10000
			REV. D1

DESIGNATION	
DISCIPLINE	
SIGNATURE	
DATE	

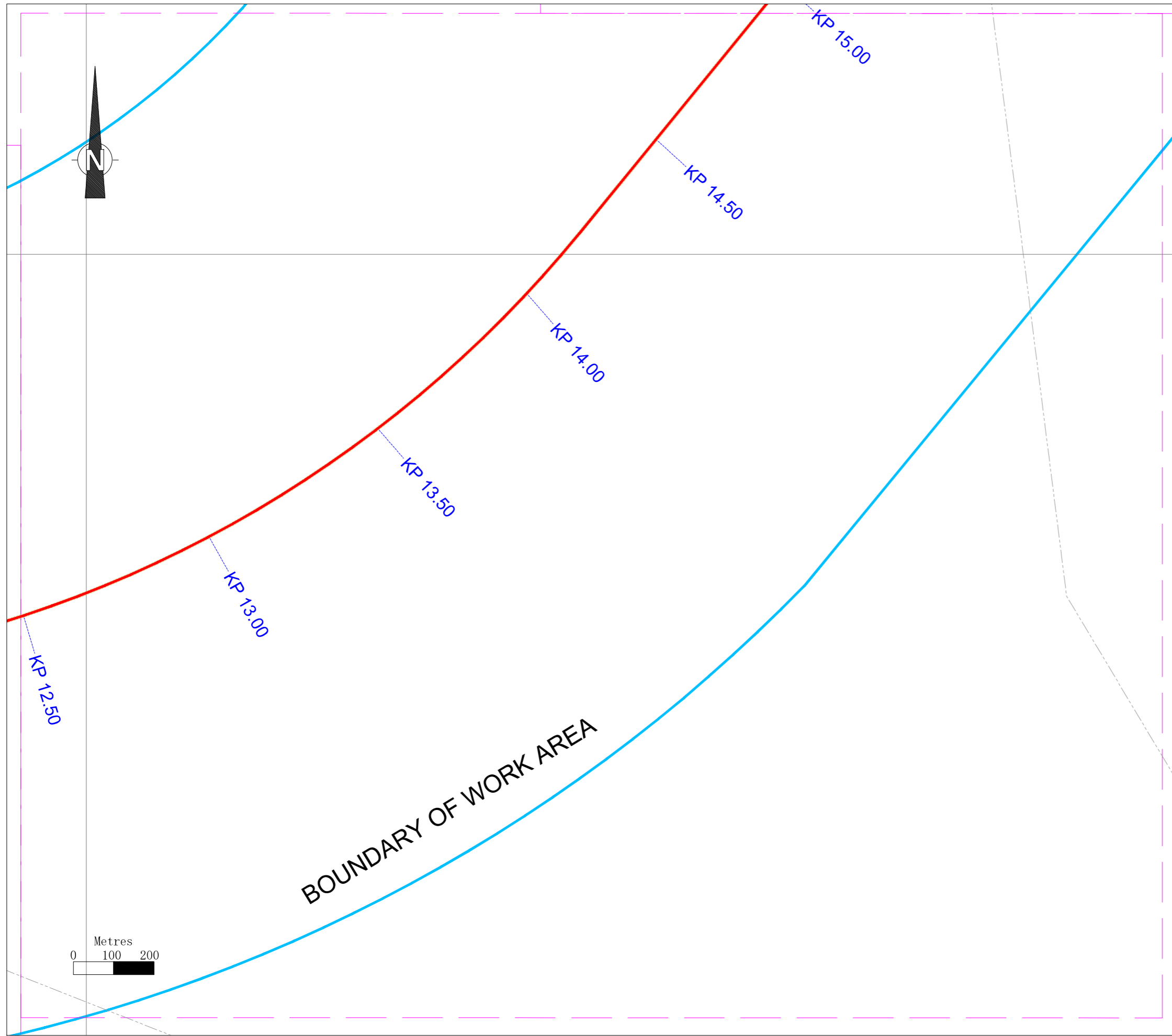

PROPOSED 20" LPS PIPELINE ROUTE

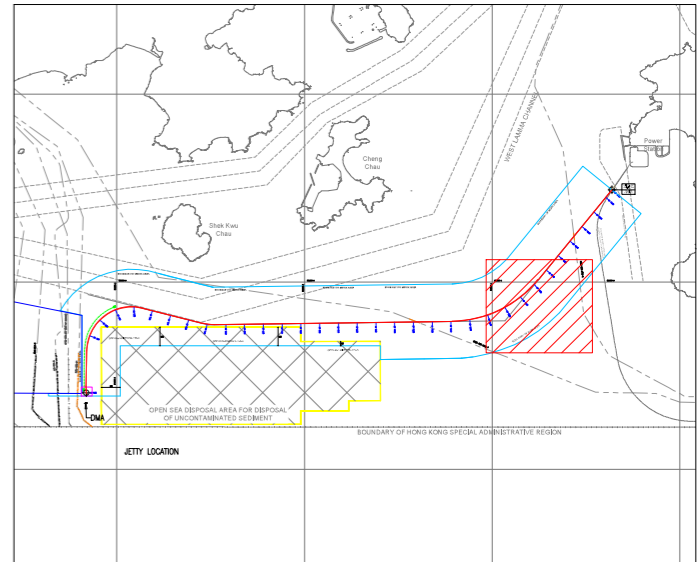

KP	WGS84		HK80	
	LATITUDE	LONGITUDE	E	N
KP12.5	22° 10.522' N	114° 3.959' E	824831	804098
KP13.0	22° 10.627' N	114° 4.227' E	825292	804292
KP13.5	22° 10.772' N	114° 4.472' E	825714	804559
KP14.0	22° 10.953' N	114° 4.688' E	826085	804893
KP14.5	22° 11.160' N	114° 4.875' E	826407	805276
KP15.0	22° 11.370' N	114° 5.059' E	826723	805663

LEGEND:

- Boundary of work area
- LPS Pipeline
- - - Drawing Cut Line

Note:
The cage type silt curtain will adopt along the LPS pipeline during dredging (KP 0-0.1) and jetting work (KP 0.1-17.30).

REVISION	No.	DATE	DESCRIPTION	BY	REV' W.	EXAM.	CLP
D1	04JAN21		Issued for Review	Liuwang	XuHB	Zhangjie	
D	29OCT20		Issued for Review	Liuwang	XuHB	Zhangjie	
C1	04JUN20		Issued for Review	Liuwang	XuHB	YeHB	
C	30APR20		Issued for Review	Liuwang	XuHB	YeHB	

CLIENT	香港電氣	Offshore Oil Engineering Co., Ltd		
SIGNATORY	SIGNATURE	DATE	PROJECT TITLE:	JOB No.
DRAWN	Liuwang	04JAN21	HONG KONG OFFSHORE LNG TERMINAL PROJECT	20ZB-DD2
DESIGNED	Liuwang	04JAN21	Works associated with the subsea gas pipeline for Lamma Power Station and the associated Gas Receiving Station in LPS	CERTIF. No.
CHECKED	XuHB	04JAN21	(Further Environment Permit No.FEP-02/558/2018/A)	A112002816
REVIEWED	Zhangjie	04JAN21	Drawing Title:	SCALE (A3)
EXAMINED			LPS Pipeline Work Area Sketch	1:10000
APPROVED			DWG No. HKOLNG-CO0EC-31EKA-CTC020-5014(7/8)	REV. D1

DESIGNATION	
DISCIPLINE	
SIGNATURE	
DATE	

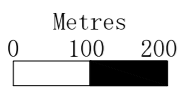
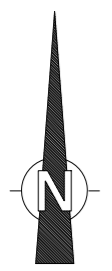
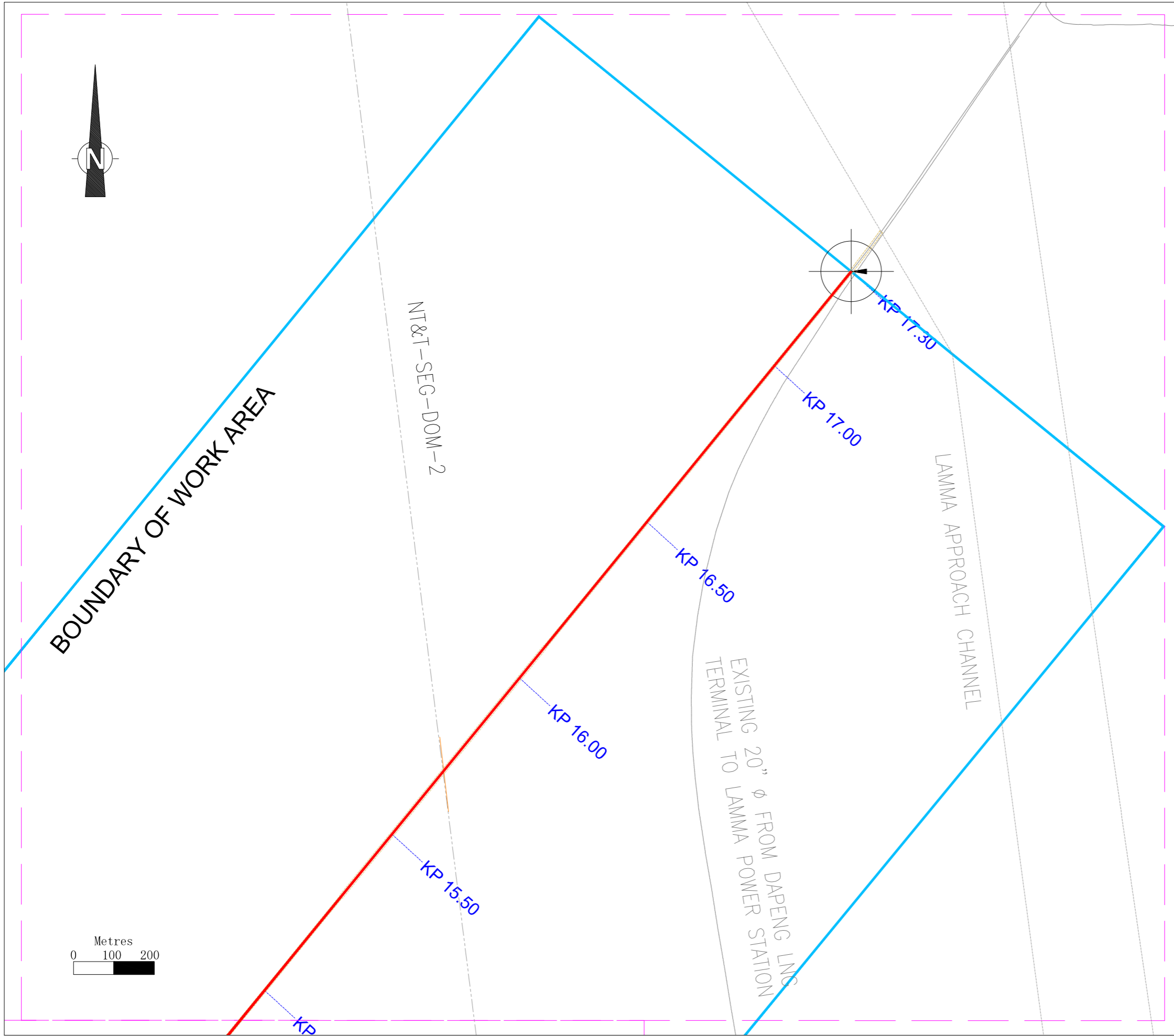

PROPOSED 20" LPS PIPELINE ROUTE

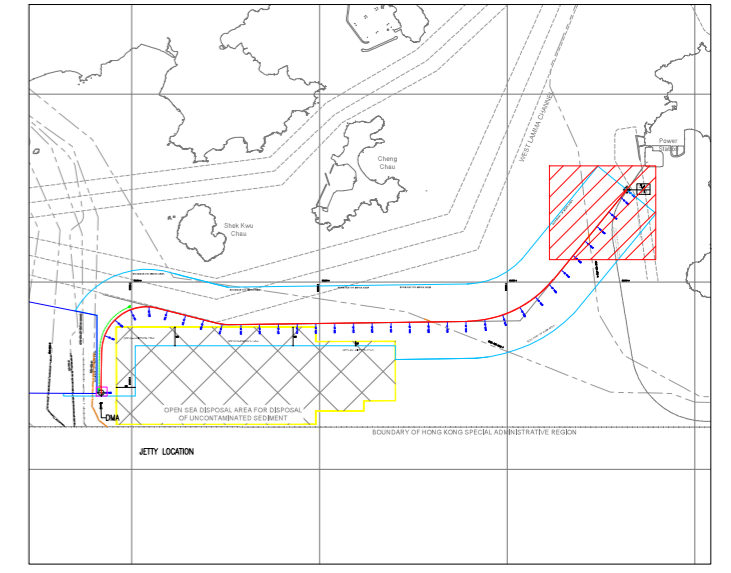

KP	WGS84		HK80	
	LATITUDE	LONGITUDE	E	N
KP15.0	22° 11.370' N	114° 5.059' E	826723	805663
KP15.5	22° 11.580' N	114° 5.243' E	827039	806050
KP16.0	22° 11.790' N	114° 5.427' E	827356	806438
KP16.5	22° 12.000' N	114° 5.611' E	827672	806825
KP17.0	22° 12.210' N	114° 5.794' E	827988	807212
KP17.3	22° 12.342' N	114° 5.910' E	828187	807456

LEGEND:

- Boundary of work area
- LPS Pipeline
- - - Drawing Cut Line

Note:
The cage type silt curtain will adopt along the LPS pipeline during dredging (KP 0-0.1) and jetting work (KP 0.1-17.30).

REVISION	No.	DATE	DESCRIPTION	BY	REV' W.	EXAM.	CLP
D1	04JAN21		Issued for Review	Liuwang	XuHB	Zhangjie	
D	29OCT20		Issued for Review	Liuwang	XuHB	Zhangjie	
C1	04JUN20		Issued for Review	Liuwang	XuHB	YeHB	
C	30APR20		Issued for Review	Liuwang	XuHB	YeHB	

CLIENT	香港電氣	Offshore Oil Engineering Co.,Ltd		
SIGNATORY	SIGNATURE	DATE	PROJECT TITLE:	JOB. No.
DRAWN	Liuwang	04JAN21	HONG KONG OFFSHORE LNG TERMINAL PROJECT	20ZB-DD2
DESIGNED	Liuwang	04JAN21	Works associated with the subsea gas pipeline for Lamna Power Station and the associated Gas Receiving Station in LPS	CERTIF. No.
CHECKED	XuHB	04JAN21	(Further Environment Permit No.FEP-02/558/2018/A)	A112002816
REVIEWED	Zhangjie	04JAN21	Drawing Title:	SCALE (A3)
EXAMINED			LPS Pipeline Work Area Sketch	1:10000
APPROVED			DWG No. HKOLNG-COEEC-31EKA-CTCO20-5014(8/8)	REV. D1

ANNEX C

VERTICAL AND HORIZONTAL ALIGNMENTS OF THE LPS PIPELINE

Attachment 2 – Vertical Alignment of LPS Pipeline

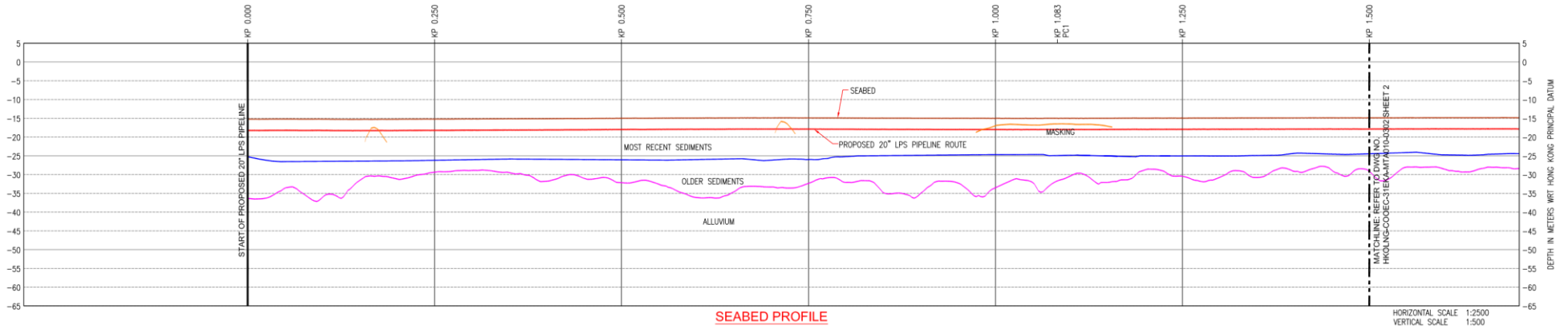

Figure 1. Seabed Profile - KP 0.0 to KP 1.5

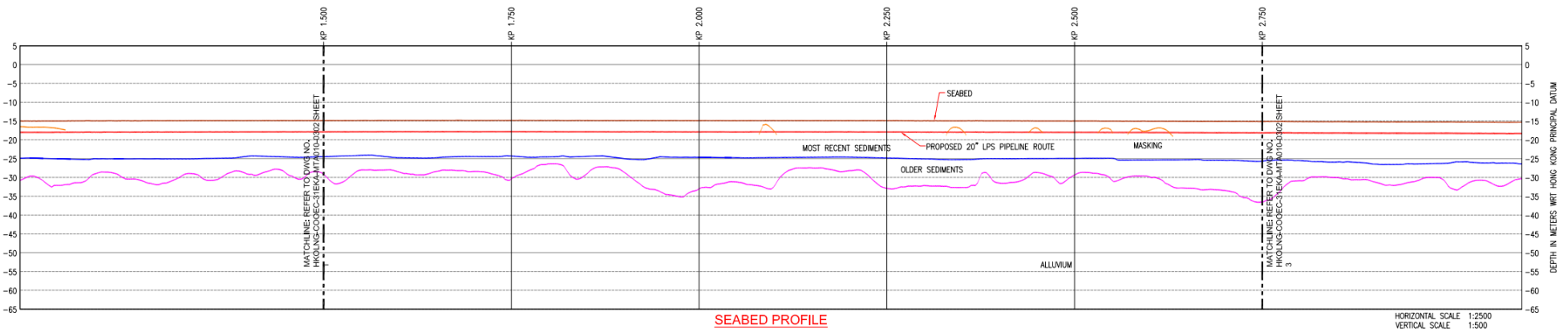

Figure 2. Seabed Profile - KP 1.5 to KP 2.75

GEOLOGICAL PROFILE

- SEABED
- MASKING
- BASE OF MOST RECENT SEDIMENTS
- BASE OF OLDER SEDIMENTS

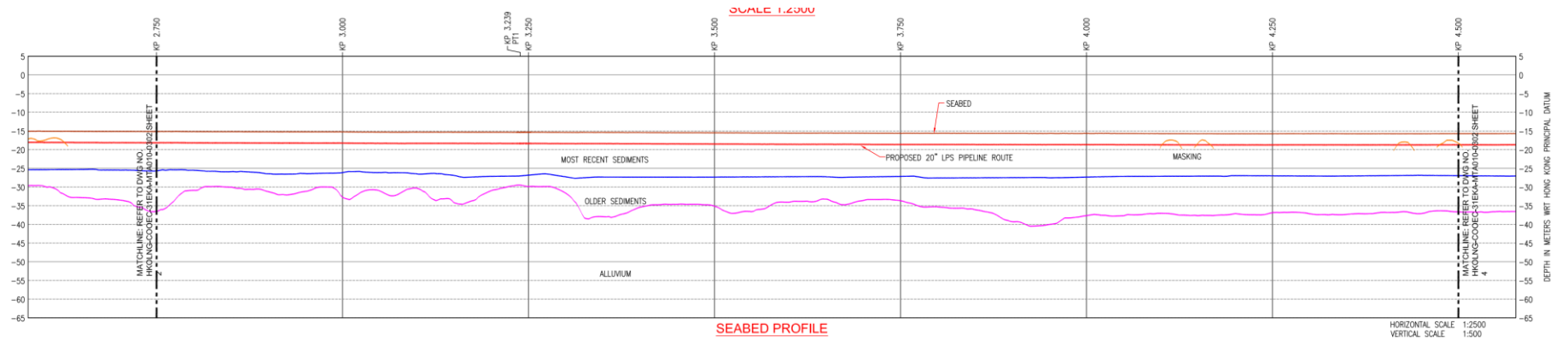

Figure 3. Seabed Profile - KP 2.75 to KP 4.5

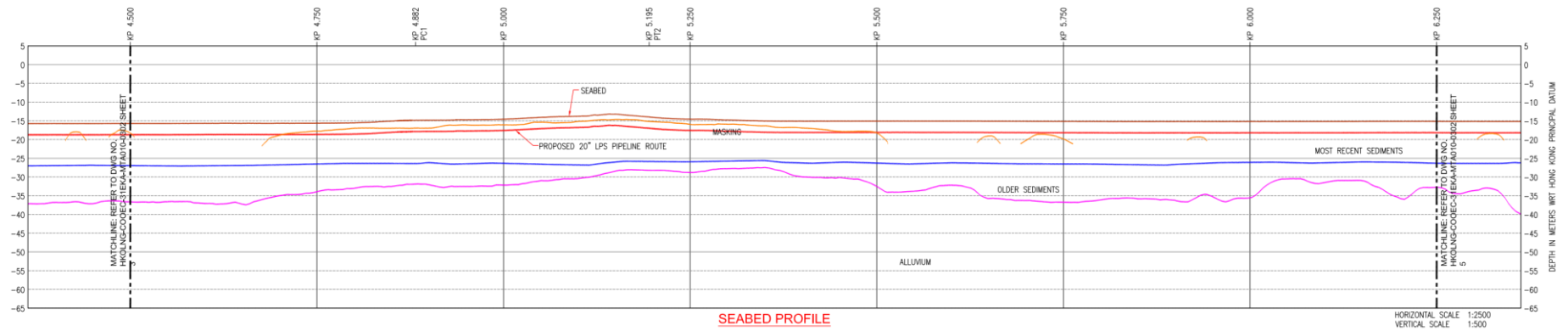

Figure 4. Seabed Profile - KP 4.5 to KP 6.25

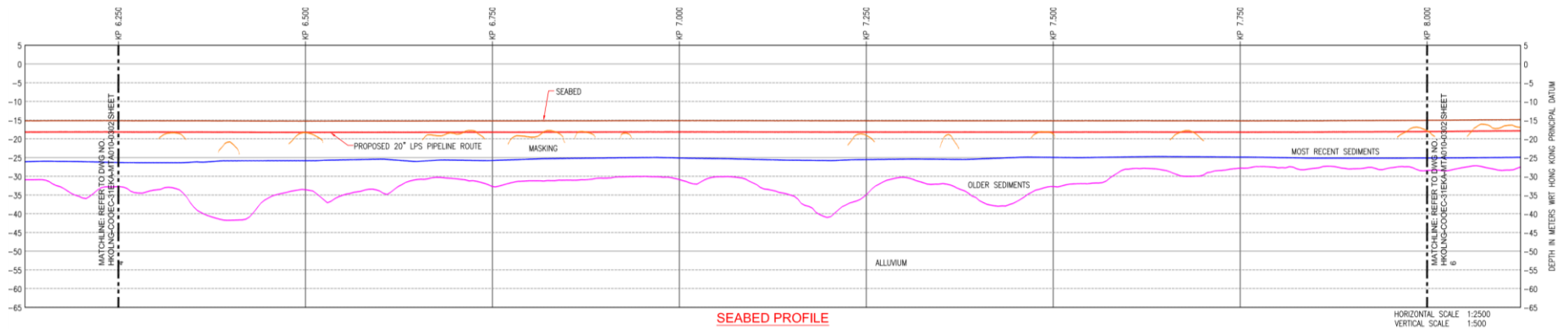

Figure 5. Seabed Profile - KP 6.25 to KP 8.00

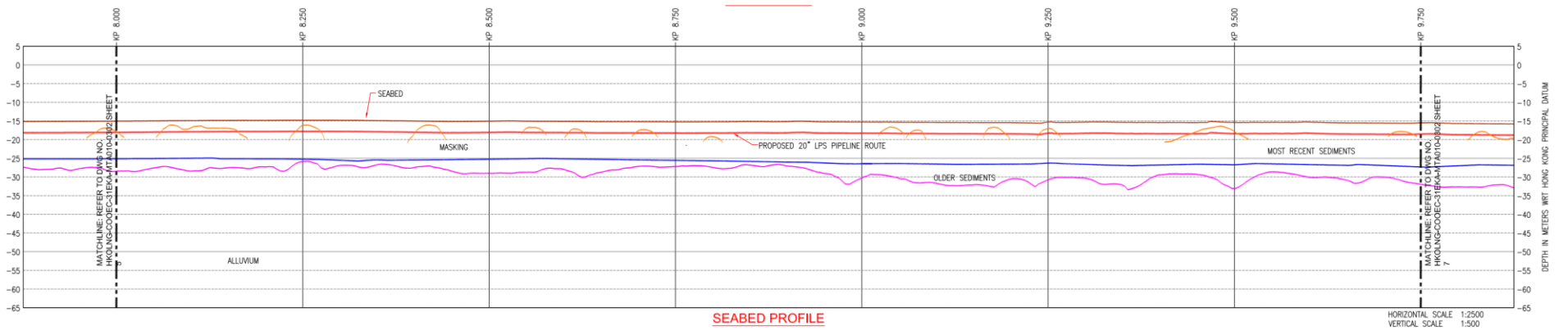

Figure 6. Seabed Profile - KP 8.00 to KP 9.75

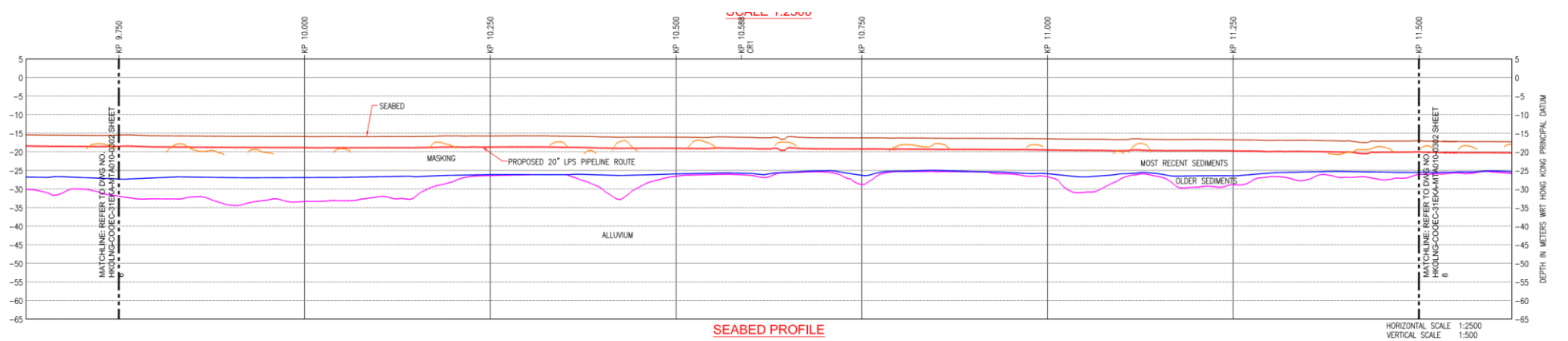

Figure 7. Seabed Profile - KP 9.75 to KP 11.5

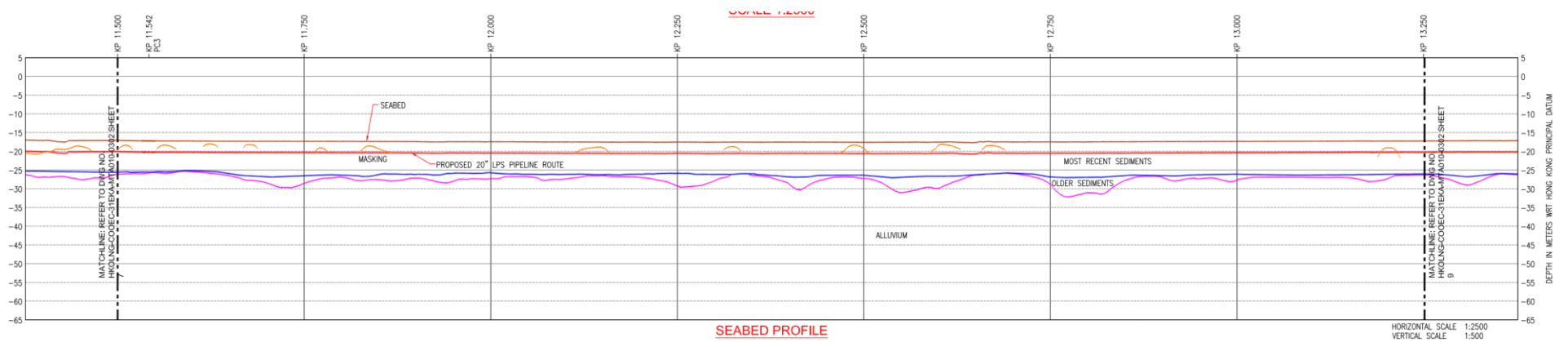

Figure 8. Seabed Profile - KP 11.5 to KP 13.25

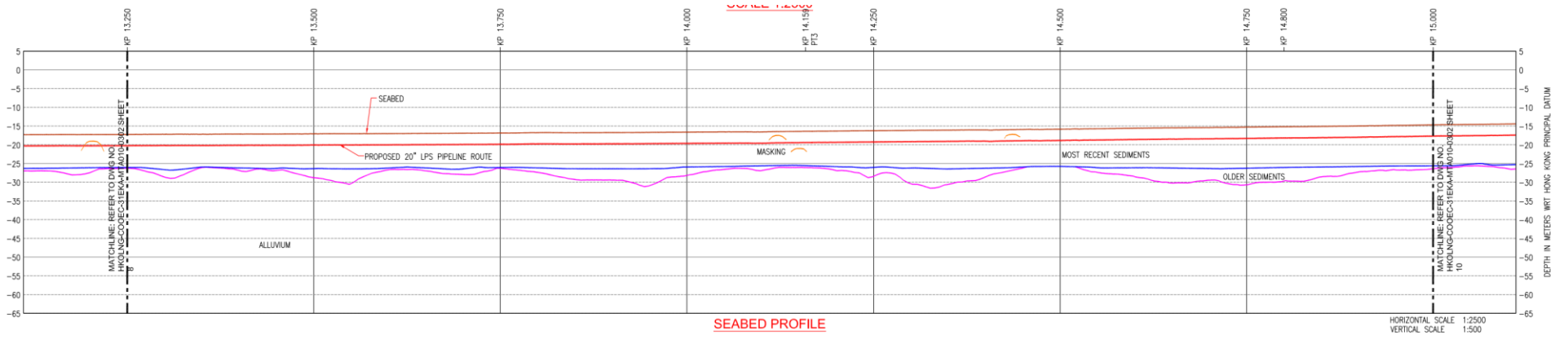

Figure 9. Seabed Profile - KP 13.25 to KP 15.00

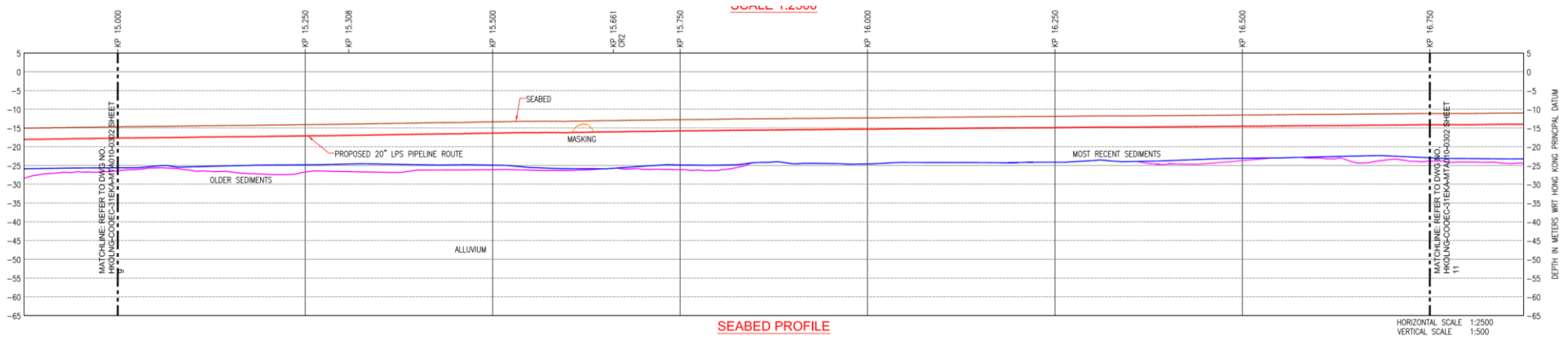

Figure 10. Seabed Profile - KP 15.00 to KP 16.75

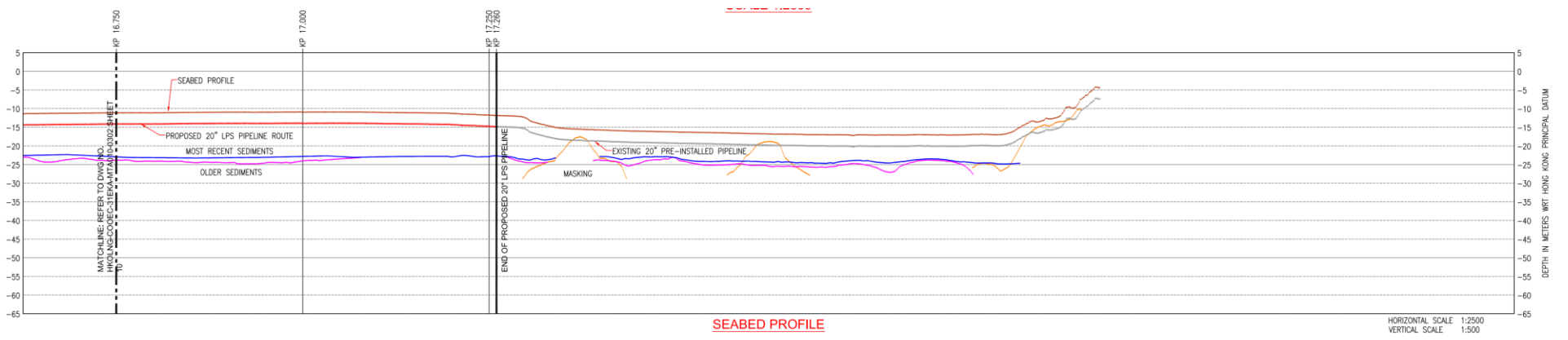

Figure 11. Seabed Profile - KP 16.75 to KP 18.5

ANNEX D

INDICATIVE WORKS AREAS FOR THE GRS AT LPS

