

**ENVIRONMENTAL PROTECTION DEPARTMENT
PRACTICE NOTE FOR PROFESSIONAL PERSONS**

Construction Site Drainage

Introduction

The purpose of this practice note is to provide some basic environmental guidelines for the handling and disposal of construction site discharges. It is hoped that through the issuance of this practice note, some of the pollution problems currently associated with construction activities can be prevented or minimized, for example :

- (i) siltation in storm drains caused by excessive sand and silt in the storm run-off;
- (ii) visual nuisance and hazard to aquatic life caused by discharge of muddy water into streams or the sea;
- (iii) pollution caused by improper handling and disposal of other types of construction site wastewater such as sewage from site toilets.

A total of ten types of discharges from construction sites have been identified. Good practice for dealing with these discharges is provided in the following sections.

Surface Run-off

2. Surface run-off from construction sites should be discharged into storm drains via adequately designed sand/silt removal facilities such as sand traps (see Appendix A1 for reference), silt traps and sediment basins. Channels or earth bunds or sand bag barriers should be provided on site to properly direct stormwater to such silt removal facilities. Perimeter channels at site boundaries should be provided where necessary to intercept storm run-off from outside the site so that it will not wash across the site. Catchpits and perimeter channels should be constructed in advance of site formation works and earthworks.

3. Silt removal facilities, channels and manholes should be maintained and the deposited silt and grit should be removed regularly, at the onset of and after each rainstorm

to ensure that these facilities are functioning properly at all times.

4. Construction works should be programmed to minimize soil excavation works in rainy seasons (April to September). If excavation in soil could not be avoided in these months or at any time of year when rainstorms are likely, for the purpose of preventing soil erosion, temporarily exposed slope surfaces should be covered e.g. by tarpaulin, and temporary access roads should be protected by crushed stone or gravel, as excavation proceeds. Intercepting channels should be provided (e.g. along the crest/edge of excavation) to prevent storm runoff from washing across exposed soil surfaces. Arrangements should always be in place to ensure that adequate surface protection measures can be safely carried out well before the arrival of a rainstorm.

5. Earthworks final surfaces should be well compacted and the subsequent permanent work or surface protection should be carried out immediately after the final surfaces are formed to prevent erosion caused by rainstorms. Appropriate drainage like intercepting channels should be provided where necessary.

6. Measures should be taken to minimize the ingress of rainwater into trenches. If excavation of trenches in wet seasons is necessary, they should be dug and backfilled in short sections. Rainwater pumped out from trenches or foundation excavations should be discharged into storm drains via silt removal facilities.

7. Open stockpiles of construction materials (e.g. aggregates, sand and fill material) on sites should be covered with tarpaulin or similar fabric during rainstorms. Measures should be taken to prevent the washing away of construction materials, soil, silt or debris into any drainage system.

8. Manholes (including newly constructed ones) should always be adequately covered and temporarily sealed so as to prevent silt, construction materials or debris from getting into the drainage system, and to prevent storm run-off from getting into foul sewers. Discharge of surface run-off into foul sewers must always be prevented in order not to unduly overload the foul sewerage system.

9. Precautions to be taken at any time of year when rainstorms are likely, actions to be taken when a rainstorm is imminent or forecast and actions to be taken during or after rainstorms are summarized in Appendix A2 for easy reference.

Groundwater

10. Groundwater pumped out of wells, etc. for the lowering of ground water level in basement or foundation construction, and groundwater seepage pumped out of tunnels or caverns under construction should be discharged into storm drains after the removal of silt in silt removal facilities.

Boring and Drilling Water

11. Water used in ground boring and drilling for site investigation or rock/soil anchoring should as far as practicable be recirculated after sedimentation. When there is a need for final disposal, the wastewater should be discharged into storm drains via silt removal facilities.

Wastewater from Concrete Batching & Precast Concrete Casting

12. Wastewater generated from the washing down of mixer trucks and drum mixers and similar equipment should wherever practicable be recycled. The discharge of wastewater should be kept to a minimum.

13. To prevent pollution from wastewater overflow, the pump sump of any water recycling system should be provided with an on-line standby pump of adequate capacity and with automatic alternating devices.

14. Under normal circumstances, surplus wastewater may be discharged into foul sewers after treatment in silt removal and pH adjustment facilities (to within the pH range of 6 to 10). Disposal of wastewater into storm drains will require more elaborate treatment. Surface run-off should be segregated from the concrete batching plant and casting yard area as much as possible, and diverted to the stormwater drainage system. Surface run-off contaminated by materials in a concrete batching plant or casting yard should be adequately treated before disposal into stormwater drains.

Wheel Washing Water

15. All vehicles and plant should be cleaned before they leave a construction site to ensure no earth, mud, debris and the like is deposited by them on roads. A wheel washing bay should be provided at every site exit if practicable and wash-water should have sand and silt settled out or removed before discharging into storm drains. The section of construction road between the wheel washing bay and the public road should be paved with backfall to reduce vehicle tracking of soil and to prevent site run-off from entering public road drains.

Bentonite Slurries

16. Bentonite slurries used in diaphragm wall and bore-pile construction should be reconditioned and reused wherever practicable. If the disposal of a certain residual quantity cannot be avoided, the used slurry may be disposed of at the marine spoil grounds subject to obtaining a marine dumping licence from EPD on a case-by-case basis.

17. If the used bentonite slurry is intended to be disposed of through the public drainage system, it should be treated to the respective effluent standards applicable to foul sewers, storm drains or the receiving waters as set out in the WPCO Technical Memorandum on Effluent Standards.

Water for Testing & Sterilization of Water Retaining Structures and Water Pipes

18. Water used in water testing to check leakage of structures and pipes should be reused for other purposes as far as practicable. Surplus unpolluted water could be discharged into storm drains.

19. Sterilization is commonly accomplished by chlorination. Specific advice from EPD should be sought during the design stage of the works with regard to the disposal of the sterilizing water. The sterilizing water should be reused wherever practicable.

Wastewater from Building Construction

20. Before commencing any demolition works, all sewer and drainage connexions should be sealed to prevent building debris, soil, sand etc. from entering public sewers/drains.

21. Wastewater generated from building construction activities including concreting, plastering, internal decoration, cleaning of works and similar activities should not be discharged into the stormwater drainage system. If the wastewater is to be discharged into foul sewers, it should undergo the removal of settleable solids in a silt removal facility, and pH adjustment as necessary.

Acid Cleaning, Etching and Pickling Wastewater

22. Acidic wastewater generated from acid cleaning, etching, pickling and similar activities should be neutralized to within the pH range of 6 to 10 before discharging into foul

sewers. If there is no public foul sewer in the vicinity, the neutralized wastewater should be tankered off site for disposal into foul sewers or treated to a standard acceptable to storm drains and the receiving waters.

Wastewater from Site Facilities

23. Sewage from toilets, kitchens and similar facilities should be discharged into a foul sewer. If there is no foul sewer in the vicinity, a septic tank and soakaway system (see Appendix B, these guidelines are for interim reference only as they are currently under review by Government) or for large flows, a sewage treatment plant will have to be provided. For sites where there are only toilet wastes arising, the use of chemical toilets may also be considered if a septic tank and soakaway system is found to be not feasible.

24. Wastewater collected from canteen kitchens, including that from basins, sinks and floor drains, should be discharged into foul sewers via grease traps capable of providing at least 20 minutes retention during peak flow. Details of a typical grease trap are given at Appendix C for reference.

25. Drainage serving an open oil filling point should be connected to storm drains via a petrol interceptor with peak storm bypass (see Appendix D for reference).

26. Vehicle and plant servicing areas, vehicle wash bays and lubrication bays should as far as possible be located within roofed areas. The drainage in these covered areas should be connected to foul sewers via a petrol interceptor (see Appendix E for reference). Oil leakage or spillage should be contained and cleaned up immediately. Waste oil should be collected and stored for recycling or disposal in accordance with the Waste Disposal Ordinance.

Licensing of Construction Site Discharges within Water Control Zones

27. All discharges into any drainage or sewerage systems, or inland or coastal waters, or into the ground (e.g. from septic tanks) within a Water Control Zone are controlled under the Water Pollution Control Ordinance (WPCO), except the discharge of domestic sewage into foul sewers or the discharge of unpolluted water into storm drains or into the waters of Hong Kong. Construction site discharges are controlled under the WPCO. The geographical extents of the Water Control Zones are shown on the map at Appendix F.

28. Discharges controlled under the WPCO must comply with the terms and conditions of a valid WPCO licence. It should be noted that compliance with the recommendations in this practice note does not necessarily imply compliance with the terms and conditions of a licence issued under the WPCO. Depending on actual site conditions, facilities in addition to those recommended in this practice note might be necessary.

29. The WPCO licence application form (Form A) can be obtained from any EPD office or from District Offices. The applicant should include in the application, inter alia, information on the various points of discharge of storm run-off and wastewater, and the corresponding maximum (or range of) volume of discharge expected on a dry day. The application form, which can be filled in by the Owner, the Authorized Person, the Consulting Engineer or the Contractor, should be submitted to EPD as early as possible before the commencement of any discharge. In general, assuming adequate information has been provided together with the licence application, EPD would need at least 20 days for the processing of a licence for a discharge, and in the case of a discharge directly into any waters of Hong Kong, EPD would need at least 50 days to allow time for public notification as required by the WPCO. (EPD General Enquiry 835 1018)

(Stuart B. Reed)

Director of Environmental Protection

Environmental Protection Department
28/F Southorn Centre
130 Hennessy Road
Wan Chai

Issued August 1994

Ref. : EP 50/D1/4

LIST OF APPENDICES

Appendix A1	:	Sand Trap (CED Standard Drawing No. GC 1034)
Appendix A2	:	Precautions/Actions relating to Rainstorms
Appendix B	:	Septic Tank and Soakaway
Appendix C	:	Grease Trap
Appendix D	:	Petrol Interceptor with Storm Bypass
Appendix E	:	Petrol Interceptor
Appendix F	:	Water Control Zones

Addendum to the ProPECC Practice Note PN 1/94

Original	Amendments
Para 29, last sentence “(EPD General Enquiry 835 1018)”	“(EPD General Enquiry 2835 1018)”

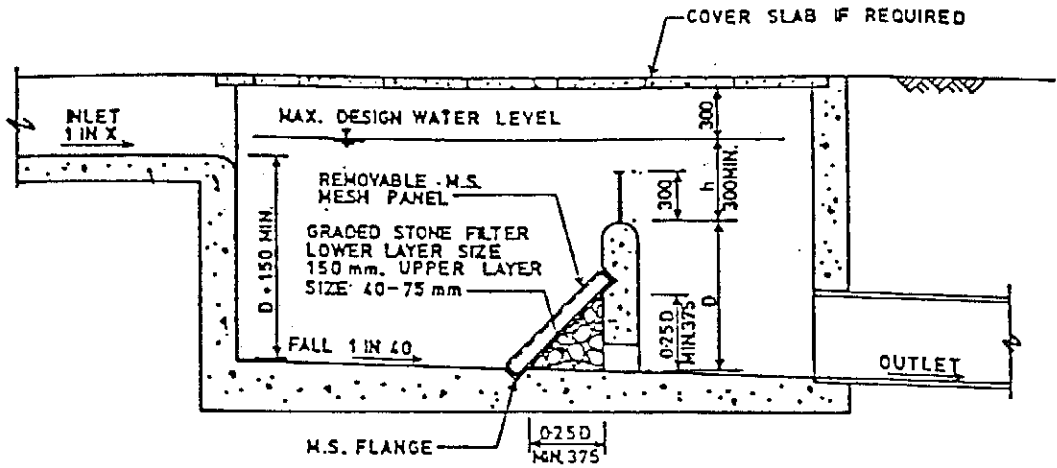

SECTION A-A

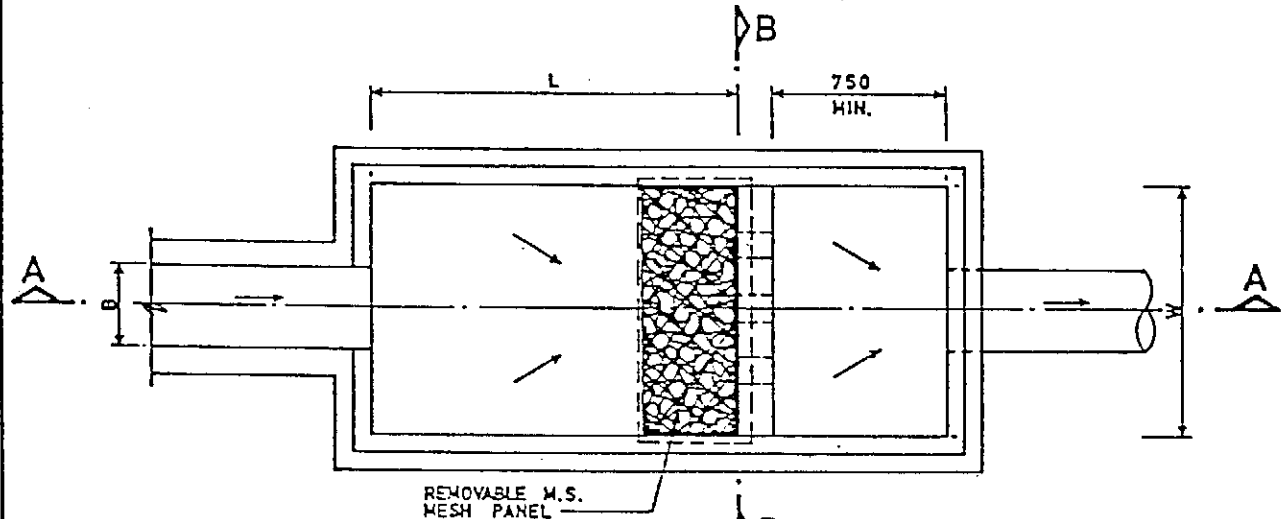

PLAN

(COVER SLAB NOT SHOWN)

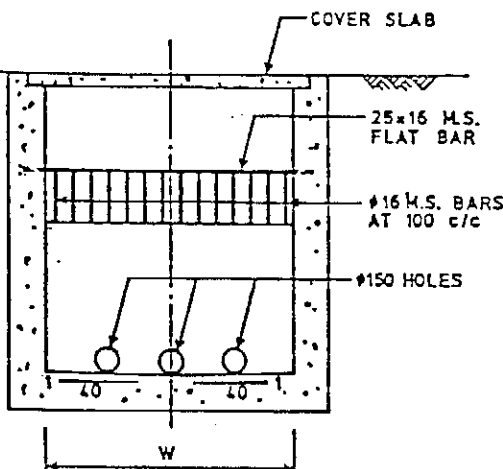

SECTION B-B

NOTES:-

1. All dimensions are in millimetres.
2. Normally for drains of 900 mm dia. and below. For bigger drains and steep terrain, sand trap should be specially designed.
3. SIZE:-
 Depth $D < 750$; Width $W \geq 3B$
 Length $L = 4.8 D^{0.67} h^{0.5} X^{0.5} \geq 4B$
4. Graded stone filter shall be crusher run granite aggregate.
5. CAPACITY:- D.W.L. to be according to size and nature of catchment, providing detention time not less than 5 minutes for max. design flow of inlet.
6. All mild steel structures to be hot dip galvanized.
7. Reinforcement to be specified.
8. Wall and slab thicknesses to be specified.

SAND TRAP

REF.	REVISION	SIGNATURE	DATE
CIVIL ENGINEERING DEPARTMENT GEOTECHNICAL ENGINEERING OFFICE			
SCALE : DIAGRAMMATIC		DRAWING NO.	
DATE : MAY 1990		GC 1034	

Precautions/Actions relating to Rainstorms

The following are extracted from the main text to highlight the specific precautions or actions concerned with rainstorms. For general precautions to be taken at all times in relation to surface run-off, please refer to Section 2 of the main text.

(I) Precautions to be taken at any time of year when rainstorms are likely

- (a) Silt removal facilities, channels and manholes should be maintained and the deposited silt and grit should be removed regularly.
- (b) Temporarily exposed slope surfaces should be covered e.g. by tarpaulin.
- (c) Temporary access roads should be protected by crushed stone or gravel.
- (d) Intercepting channels should be provided (e.g. along the crest/edge of excavation) to prevent storm runoff from washing across exposed soil surfaces.
- (e) Trenches should be dug and backfilled in short sections. Measures should be taken to minimize the ingress of rainwater into trenches.

(II) Actions to be taken when a rainstorm is imminent or forecast

- (a) Silt removal facilities, channels and manholes should be checked to ensure that they can function properly.
- (b) Open stockpiles of construction materials (e.g. aggregates, sand and fill materials) on site should be covered with tarpaulin or similar fabric.
- (c) All temporary covers to slopes and stockpiles should be secured.

(III) Actions to be taken during or after rainstorms

- (a) Silt removal facilities, channels and manholes should be checked and maintained to ensure satisfactory working conditions. Attention should be given to safety when carrying out this work.

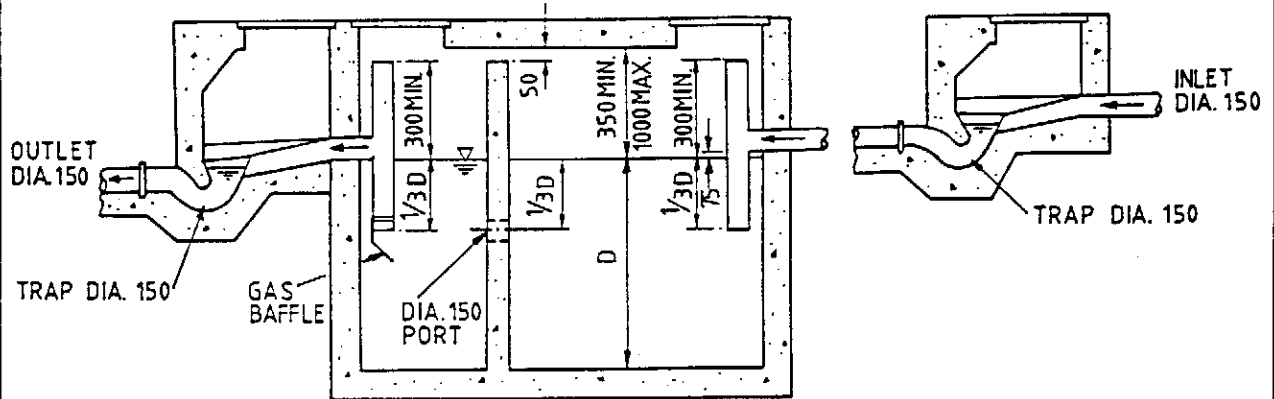

SECTION A-A

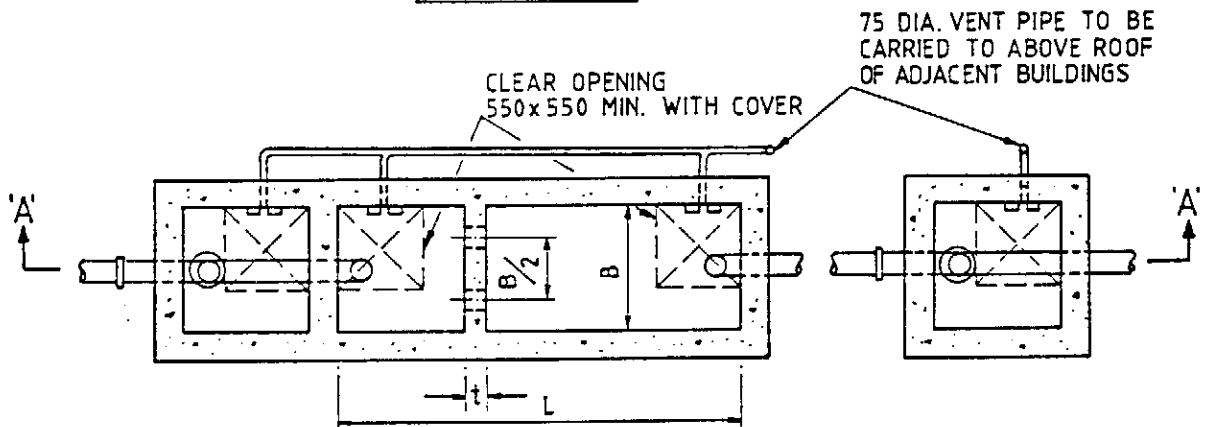

PLAN

NOTES:-

1. ALL DIMENSIONS IN MILLIMETRES UNLESS OTHERWISE STATED.
2. SIZE
 - a. $4B \geq L > 3B$
 - b. $1800 \text{ mm} \geq D > 1200 \text{ mm}$
 - c. RATIO OF VOLUMES OF FIRST AND SECOND CHAMBERS = 2 : 1
3. CAPACITY (SUBJECT TO NOTE 2)
 - a. CAPACITY $C = (L - t) \times B \times D$
 - b. NOT LESS THAN 2.3 m^3 BUT NOT MORE THAN 41 m^3
 - c. NOT LESS THAN $0.1N$ WHERE N IS THE NUMBER OF PERSONS SERVED AND Q IS THE ESTIMATED ULTIMATE PER CAPITA DAILY WATER CONSUMPTION
 - d. SURFACE WATER MUST NOT BE CONNECTED TO THE TANK
 - e. TANK TO BE DESLUDGED EVERY 6 MONTHS
4. NO OVERFLOW OR BYPASS PIPE IS ALLOWED.
5. PLEASE REFER TO THE BOOKLET "GUIDANCE NOTES ON DISCHARGES FROM VILLAGE HOUSES" PUBLISHED BY EPD FOR FURTHER GUIDELINES ON OPERATION AND MAINTENANCE OF SEPTIC TANK SYSTEM.

SEPTIC TANK
(FOR INTERIM REFERENCE ONLY)

drawing no. EP 50/D/1/5/01		group Liquid Waste Projects	
date 5/93	scale NTS	ENVIRONMENTAL PROTECTION DEPARTMENT HONG KONG	

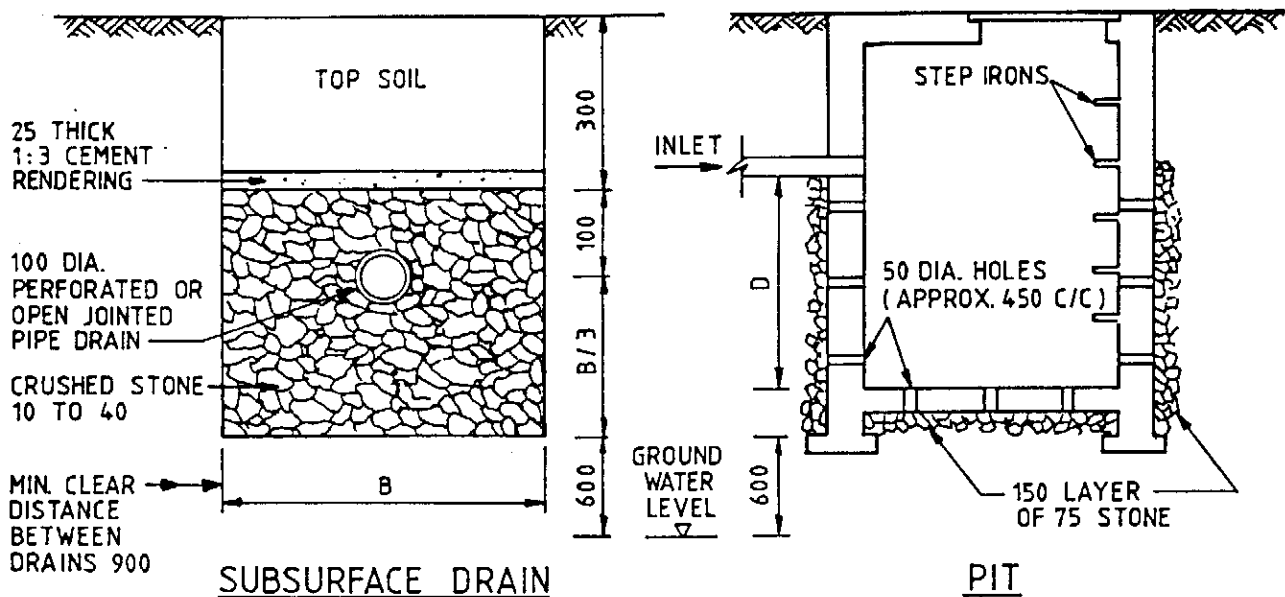

- NOTES:-**
- ALL DIMENSIONS IN MILLIMETRES UNLESS OTHERWISE STATED
 - PERCOLATION TEST FOR DETERMINING ABSORPTION CAPACITY OF SOIL
 - EXCAVATE A HOLE 300 mm SQUARE TO THE SAME DEPTH OF THE PIT OR TRENCH.
 - FILL THE HOLE WITH APPROXIMATELY 150 mm OF WATER AND ALLOW TO SEEP AWAY COMPLETELY.
 - REFILL THE HOLE WITH WATER TO A DEPTH OF 150 mm AND OBSERVE THE TIME, IN MINUTES, FOR WATER TO SEEP COMPLETELY AWAY.
 - DIVIDE THE TIME BY 6 TO GIVE TIME TAKEN TO FALL 25 mm FOR USE IN TABLE BELOW.
 - ALLOWABLE LOADING OF SOAKAWAY SYSTEMS

TIME IN MINUTES FOR WATER TO FALL 25 mm IN TEST PIT	ALLOWABLE LOADING IN LITRES PER m ² PER DAY	
	DRAIN TRENCH BOTTOM AREA	PIT PERCOLATION AREA
1 OR LESS	163	216
2	130	175
5	98	130
10	89	94
30	33	45

THE TOTAL ALLOWABLE LOADING PER DAY SHOULD EQUATE WITH THE DAILY INCOMING FLOW

4. MINIMUM CLEARANCE REQUIREMENTS FOR SOAKAWAY SYSTEMS

	DISTANCE FROM SOAKAWAY SYSTEMS (m)	
BUILDING	3	
RETAINING WALLS	6	
WELLS	50	
STREAM WHERE THE BED IS LOWER THAN INVERT OF SOAKAWAY SYSTEM	15 (30)*	* THESE DISTANCES SHOULD BE INCREASED TO DISTANCES SHOWN IN BRACKETS IF THE WATER FROM THE STREAM OR POOL IS USED OR LIKELY TO BE USED FOR DRINKING OR DOMESTIC PURPOSES.
POOLS	7.5 (30)*	
CUTS OR EMBANKMENTS	30	
PATHS	1.5	
BEACHES	100	(FROM BOUNDARIES OF GAZETTED BEACHES OR BATHING BEACH SUBZONES OF WATER CONTROL ZONES)
	30	(FROM H.W.M. AND FROM NEAREST WATERCOURSES FOR OTHER CASES)
GROUND WATER TABLE	0.6	(BELOW INVERT)

**SOIL SOAKAWAY SYSTEM
(FOR INTERIM REFERENCE ONLY)**

drawing no.
EP 50/D1/5/02

group
Liquid Waste Projects

date
5/93

scale
NTS

ENVIRONMENTAL
PROTECTION
DEPARTMENT
HONG KONG



Grease Traps

(see Drawing no. EP 50/L1/1/01A for typical details of a grease trap)

<u>Kitchen Floor Area</u> (m ²)	<u>Peaking Factor</u>	<u>Minimum Required Grease Trap Retention Volume</u> (m ³)
12	5.5	0.7
24	4.3	1.1
50	3.0	1.6
100	2.4	2.5
150		3.3
200	1.85	4.0
250		4.7
300		5.4
350		6.1
400	1.62	6.7
450		7.3
500		7.8
550		8.3
600	1.38	8.7
650		9.1
700		9.4
750		9.7
800	1.15	10.0
850		10.2
900	1.03	10.3
1000	1.0	10.4

- Note
1. The minimum required grease trap retention volume tabulated above is based on an average water consumption of 0.5 m³ per day per m² of kitchen floor area, and an average working day of 16 working hours. A larger grease trap should be provided if a higher water discharge intensity is anticipated.
 2. For kitchen floor areas in between the listed values, the minimum required grease trap retention volume can be calculated pro-rata.
 3. For kitchen floor areas smaller than 12 m², a grease trap with retention volume 0.7 m³ should be provided unless the adequacy of a smaller grease trap can be demonstrated.
 4. Depending on the actual operation of the proposed food premises, additional installations might be required to meet the standards given in the Technical Memorandum issued under section 21 of the Water Pollution Control (Amendment) Ordinance 1990.

Notes

1. All dimensions are in millimetres unless otherwise stated
2. Volume = $B(L_1 + L_2)H$
3. $750 \leq B \leq L_1 \leq L_2 \leq 1800$
4. $600 \leq H \leq 1200$
For kitchen floor areas $\geq 50 \text{ m}^2$, H should be 900 minimum
5. $L_1 + L_2 = L_T$
 $2.0 \leq L_T/H \leq 3.0$
 $1500 \leq B \times L_T/H \leq 4000$
6. A = H/2 but not greater than 450
7. No. of pipes through the middle partition wall should be such that the velocity inside the pipes is not greater than 0.2 m/s
8. Gradient of inlet pipe > 1 in 10
9. Horizontal pipe between the last drainage funnel and the grease trap should not be longer than 10m. Where this cannot be achieved, the gradient of the pipe should be increased and rodding eyes should also be provided
10. Minimum diameter of inlet pipes 100mm
11. Minimum diameter of vent pipes 75mm
12. Reinforced concrete grease traps should be designed as liquid retaining structure with maximum surface crack widths 0.2mm
13. Grease traps should be easily accessible, allowing covers to be lifted and accumulated materials removed
14. A prominent sign should be erected adjacent to the grease trap to signify the location of the grease trap and should also contain the following information:
 - a) overall depth of the grease trap
 - b) liquid depth of the grease trap
 - c) the grease trap needs cleaning when the top 200mm of liquid depth is occupied by grease
 - d) warning signs and safety barriers should be erected around the manhole openings during cleaning and maintenance of the grease trap

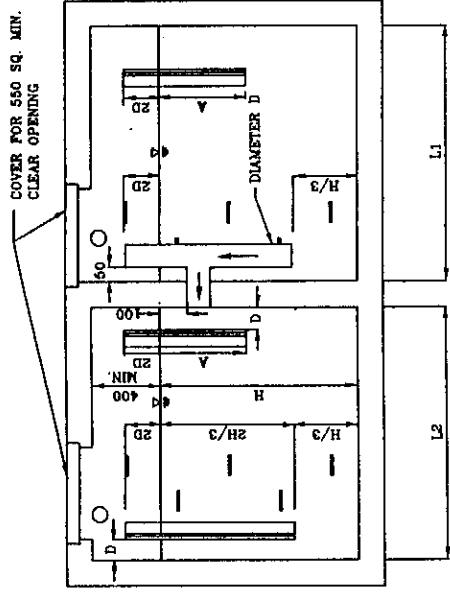

SECTION X-X

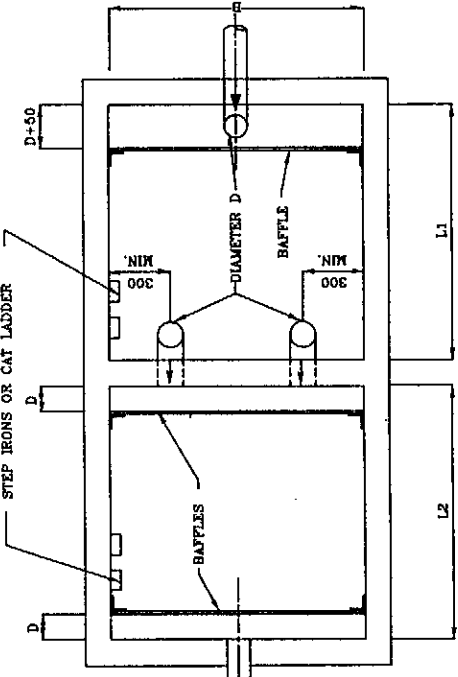

SECTION Y-Y

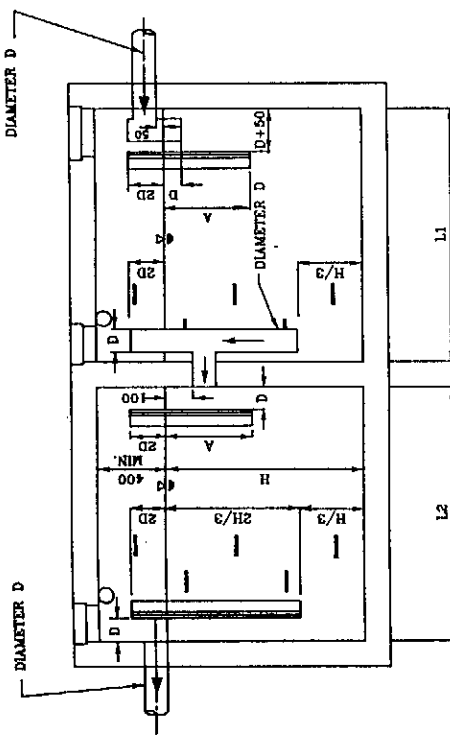

PLAN

CLEAR OPENING
550 X 550 MIN.
WITH COVER

TYPICAL DETAILS OF A GREASE TRAP

Drawing No.	Scale:
EP50/L1/1/01A	NTS
Group	LIQUID WASTE PROJECTS

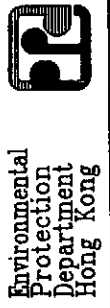

GENERAL NOTES :

1. THE PETROL INTERCEPTOR IS DESIGNED TO PROVIDE AT LEAST 20 MINUTES RETENTION TO 5-10% OF THE MAXIMUM RUNOFF COLLECTED BY THE TRANSPORT INTERCHANGE IN A 1 IN 2 YEAR RAINSTORM.
2. DETAILS OF PETROL INTERCEPTOR SHOWN IN THESE DRAWING IS FOR OPEN SPACE PUBLIC TRANSPORT INTERCHANGE. FOR PETROL INTERCEPTOR AT COVERED PUBLIC TRANSPORT INTERCHANGE SEE CEO STANDARD DRAWING CE 1041.
3. ALL DIMENSIONS ARE IN MILLIMETRES.
4. CONCRETE TO BE GRADE 30/20.
5. REINFORCEMENT SHALL COMPLY TO BS 4449 AND SHALL BE BENT IN ACCORDANCE WITH BS 4466.
6. COVER TO REINFORCEMENT TO BE 50 mm UNLESS OTHERWISE SPECIFIED.
7. REINFORCEMENT NOTATION :

No. OF SETS	3	x	3	R12	-	5	-	200	B	
No. OFF										SUFFIX
BAR CLASS										SPACING
DIAMETER										BAR MARK

BAR CLASS - R= GRADE 250 PLAIN ROUND STEEL BAR

SUFFIX --- T= TOP

B= BOTTOM

NF= NEAR FACE

FF= FAR FACE

EF= EACH FACE

8. MINIMUM LAP LENGTH : 40 DIAMETER OF BAR FOR MILD STEEL PLAIN BAR.
9. STRUCTURAL STEELWORK SHALL BE GRADE 43C COMPLY WITH BS 4360 UNLESS OTHERWISE SPECIFIED.
10. ALL FILLET WELDS TO BE 6 mm UNLESS OTHERWISE SPECIFIED.
11. STAINLESS STEEL ACCESS LADDER TO BE OF MINIMUM GRADE 304 S12 TO BS 970:PT1:1983.
12. FOR RSJ CONNECTIONS, SEE CEO STANDARD DRAWING CE 1020.
13. FOR DETAILS OF TOP TREATMENT TO PETROL INTERCEPTOR, SEE CEO STANDARD DRAWING CE 1021 FOR FLEXIBLE ROAD SURFACE AND HIGHWAY STANDARD DRAWING H 1006 FOR CONCRETE ROAD SLAB.
14. FOR DETAILS OF COVER TO PETROL INTERCEPTOR, SEE CEO STANDARD DRAWING CE 1022.
15. FOR DETAILS OF DESILTING OPENING COVER, SEE CEO STANDARD DRAWING CE 1023.

NEW ISSUE

NL 7/91

PETROL INTERCEPTOR
FOR OPEN PUBLIC
TRANSPORT INTERCHANGE

HIGHWAYS DEPARTMENT

REFERENCE

DRAWING No.

SCALE

H 3028/1

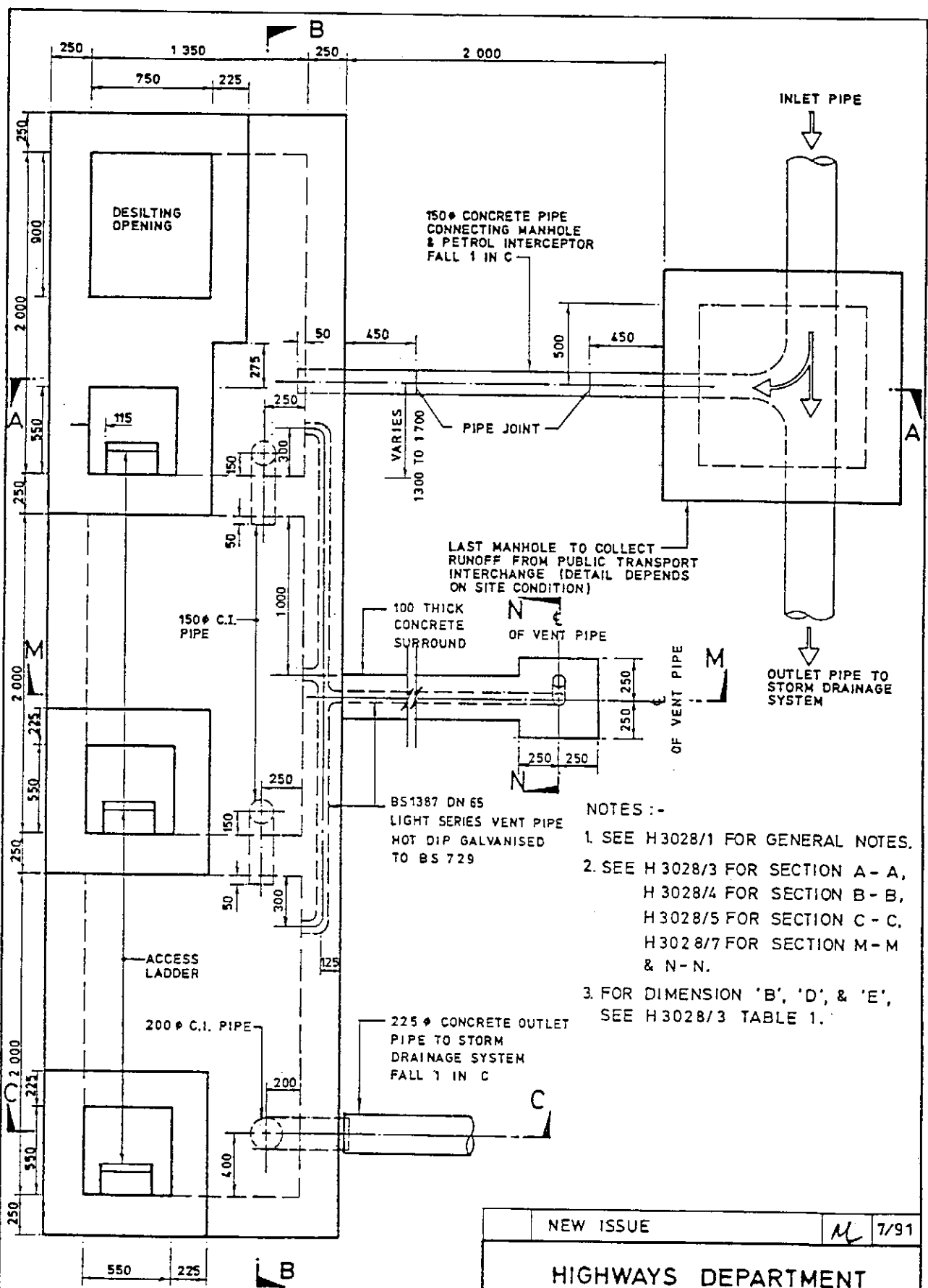

LAST MANHOLE TO COLLECT RUNOFF FROM PUBLIC TRANSPORT INTERCHANGE (DETAIL DEPENDS ON SITE CONDITION)

NOTES :-

1. SEE H 3028/1 FOR GENERAL NOTES.
2. SEE H 3028/3 FOR SECTION A - A, H 3028/4 FOR SECTION B - B, H 3028/5 FOR SECTION C - C, H 3028/7 FOR SECTION M - M & N - N.
3. FOR DIMENSION 'B', 'D', & 'E', SEE H 3028/3 TABLE 1.

PLAN

(3 COMPARTMENT PETROL INTERCEPTOR SHOWN, FOR REQUIRED No. OF COMPARTMENTS, SEE TABLE 1)

NEW ISSUE		M	7/91
HIGHWAYS DEPARTMENT			
REFERENCE		DRAWING No.	
SCALE		H 3028/2	
DIAGRAMMATIC			

NOTES :-
SEE H 3028/1 FOR GENERAL NOTES

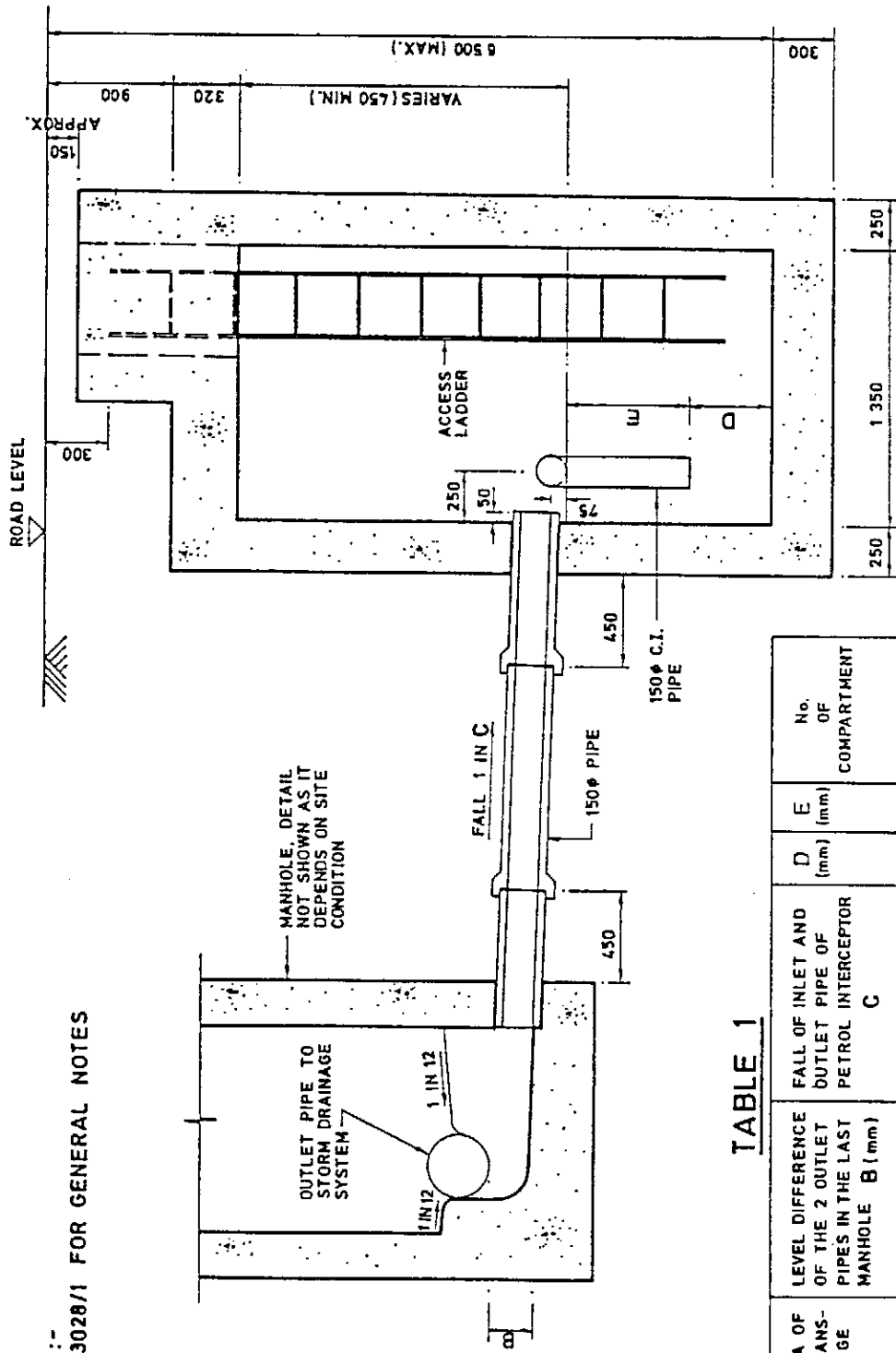

TABLE 1

CATCHMENT AREA OF THE PUBLIC TRANS-PORT INTERCHANGE A (m ²)	LEVEL DIFFERENCE OF THE 2 OUTLET PIPES IN THE LAST MANHOLE B (mm)	FALL OF INLET AND OUTLET PIPE OF PETROL INTERCEPTOR C	D (mm)	E (mm)	No. OF COMPARTMENT
A ≤ 1 000	60	2 00	500	400	2
1 000 < A ≤ 2 000	90	2 00	600	400	3
2 000 < A ≤ 3 000	150	2 00	550	600	4
3 000 < A ≤ 4 000	150	1 00	725	600	4

SECTION A-A

NEW ISSUE M 7/91

HIGHWAYS DEPARTMENT

REFERENCE DRAWING No.

SCALE H 3028/3

DIAGRAMMATIC

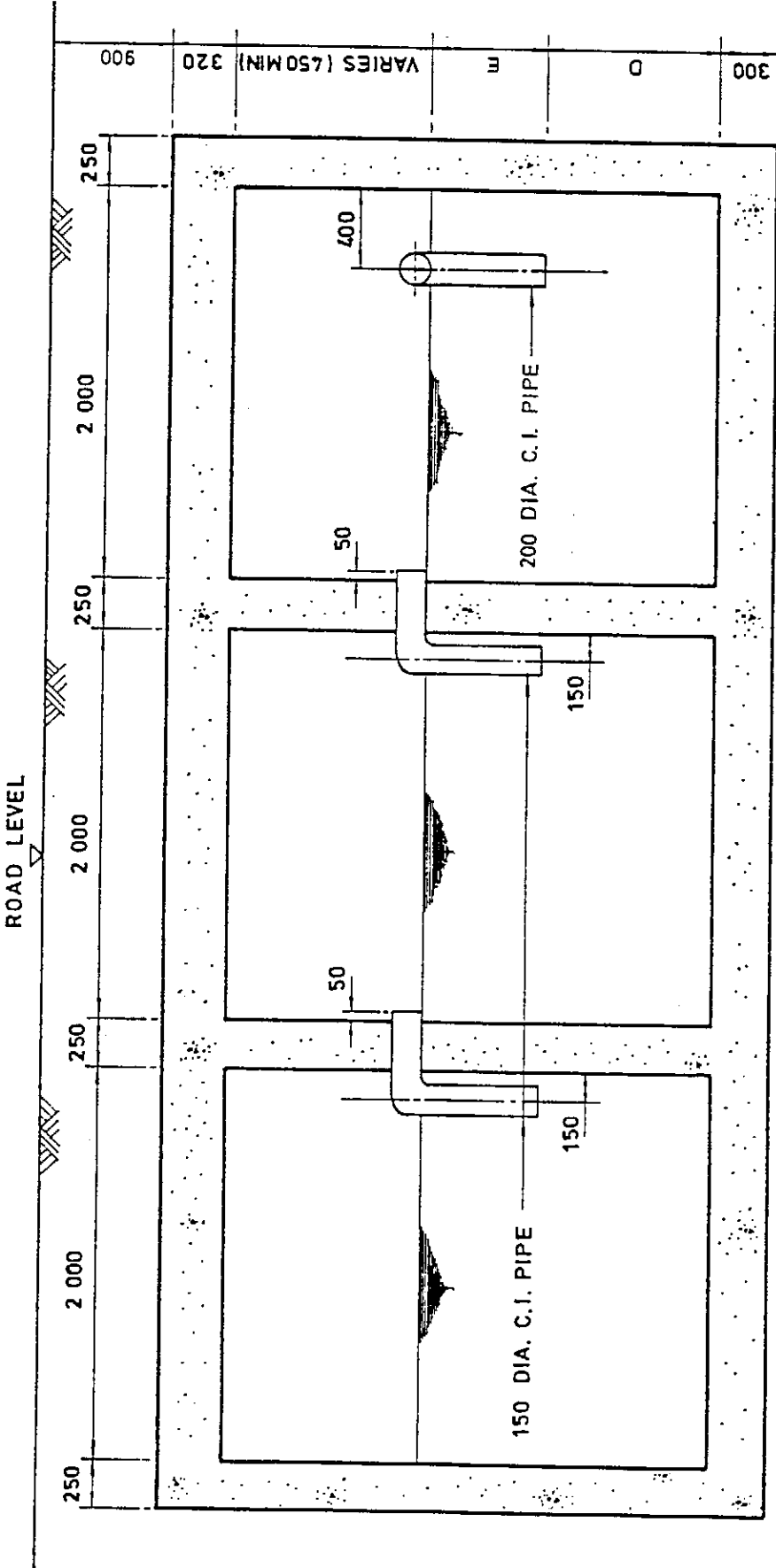

SECTION B-B
 (3 COMPARTMENT PETROL
 INTERCEPTOR SHOWN)

NOTES :-
 SEE H3028/1 FOR GENERAL NOTES

NEW ISSUE	N/L	7/91
HIGHWAYS DEPARTMENT		
REFERENCE	DRAWING No.	
SCALE	H 3028/4	
DIAGRAMMATIC		

NOTES :-
SEE H 3028/1 FOR GENERAL NOTES

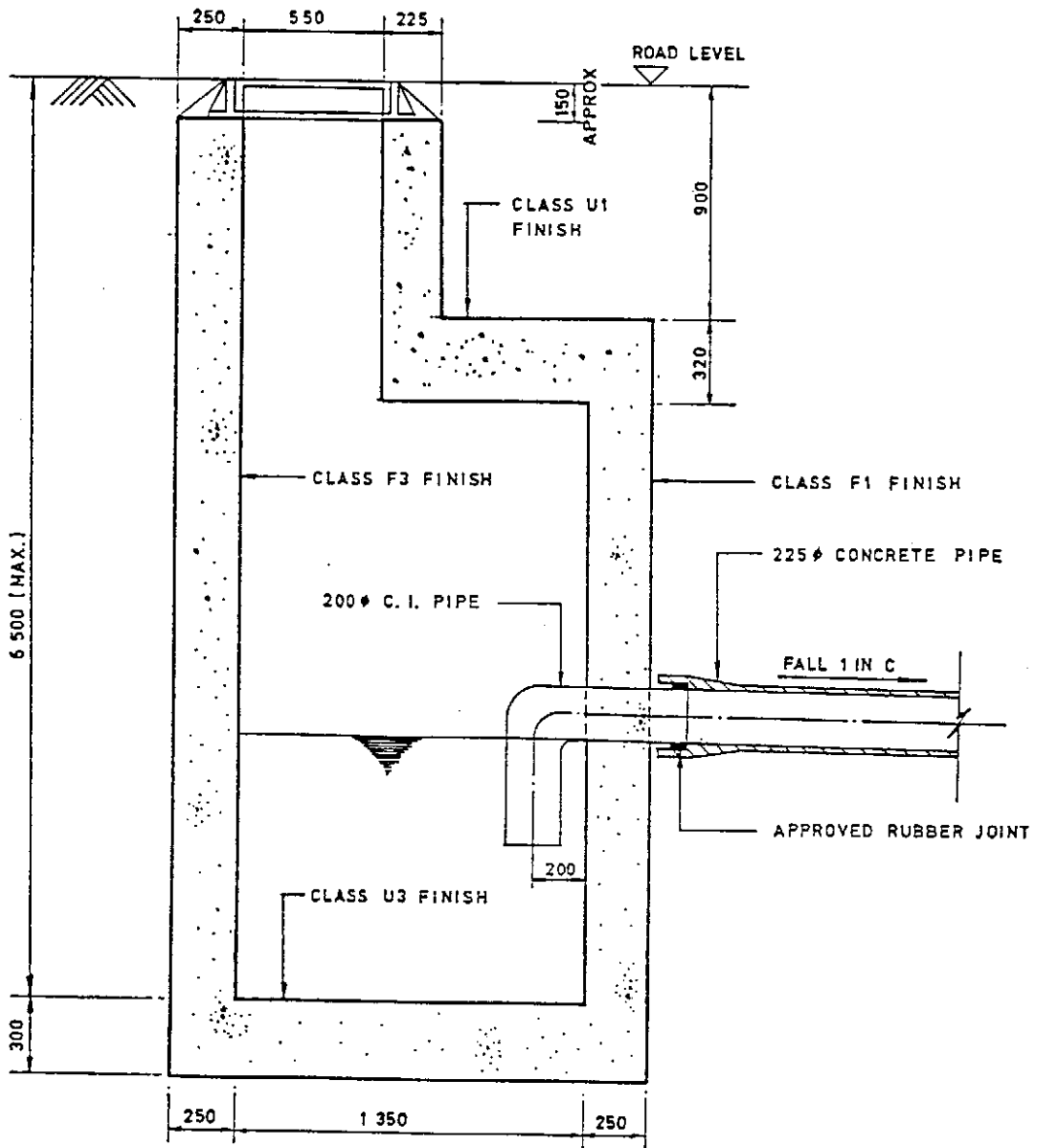

SECTION C-C

NEW ISSUE		NL	7/91
HIGHWAYS DEPARTMENT			
REFERENCE		DRAWING No.	
SCALE		H 3028/5	
1: 25			

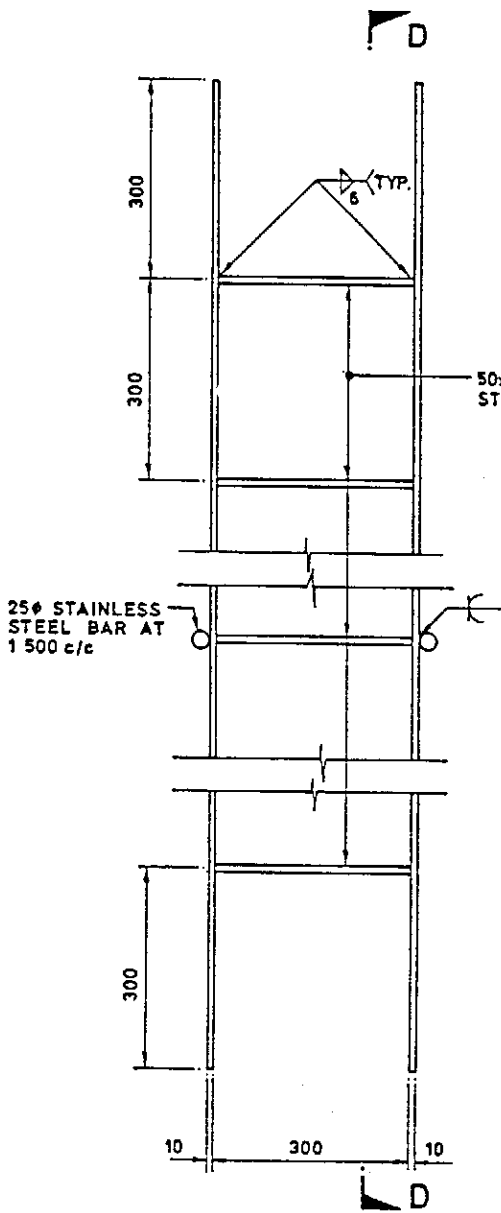

ELEVATION

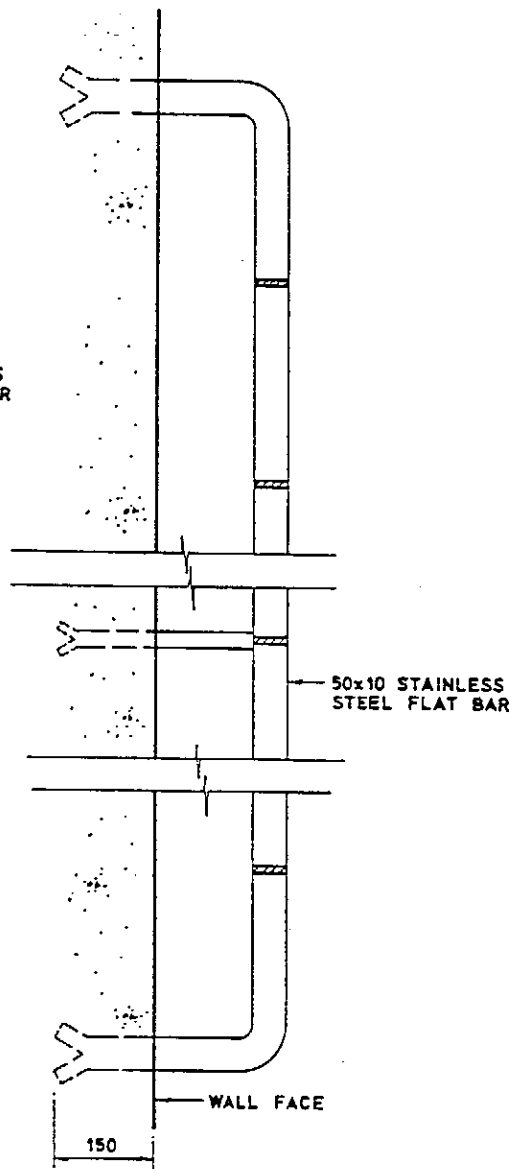

SECTION D-D

NOTES:-
SEE H 3028/1 FOR GENERAL NOTES

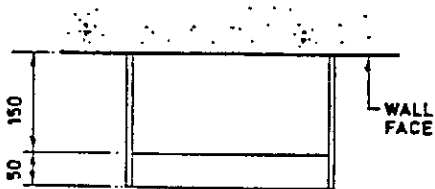

PLAN

ACCESS LADDER

NEW ISSUE		NL	7/91
HIGHWAYS DEPARTMENT			
REFERENCE		DRAWING No.	
SCALE		H 3028/6	
1 : 10			

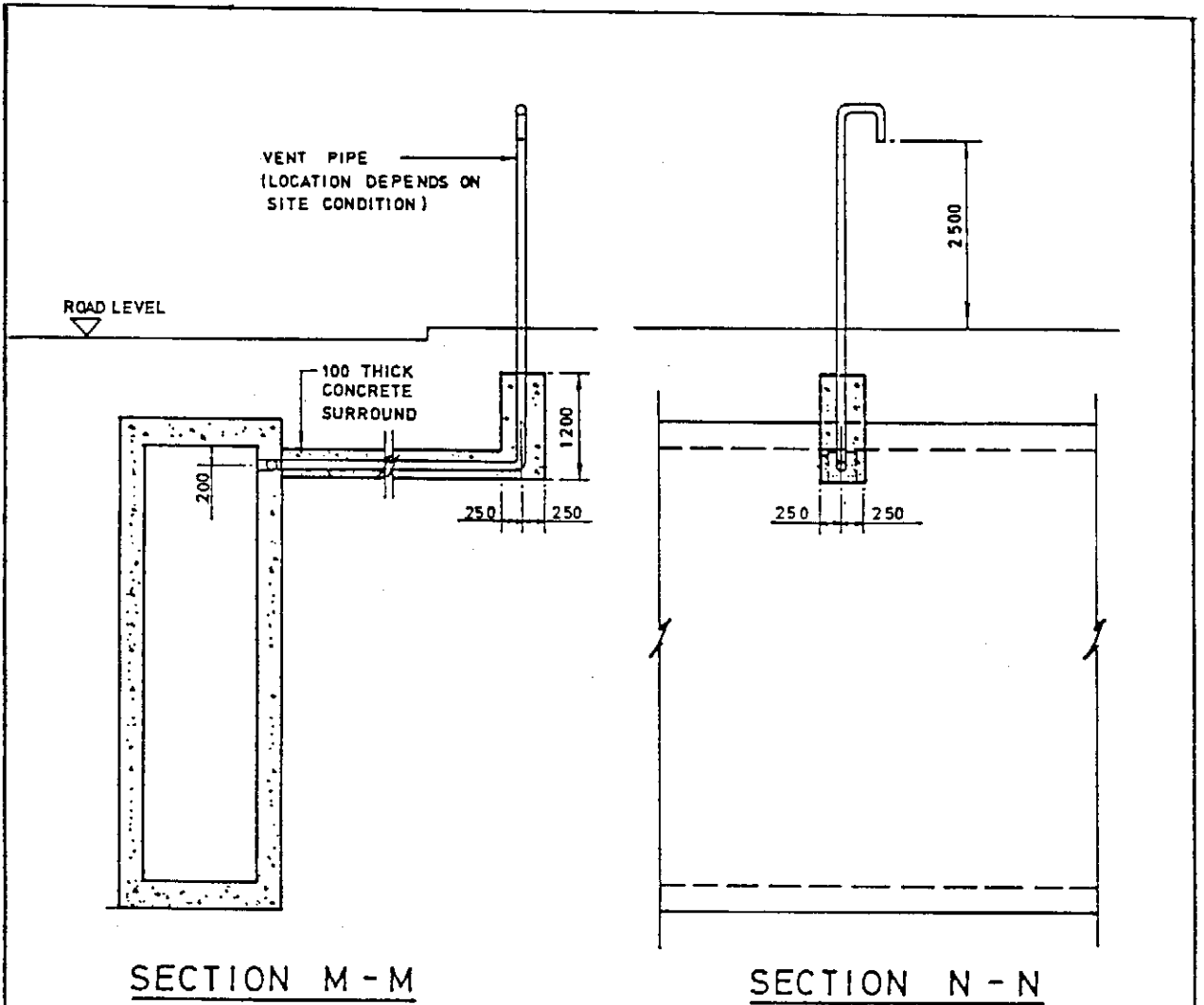

NOTES:-

SEE H3028/1 FOR GENERAL NOTES

NEW ISSUE		NL	7/91
HIGHWAYS DEPARTMENT			
REFERENCE		DRAWING No.	
SCALE		H 3028/7	
DIAGRAMMATIC			

NOTES :-
SEE H 3028/1 FOR GENERAL NOTES

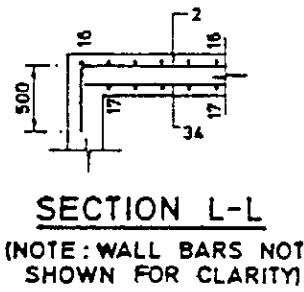
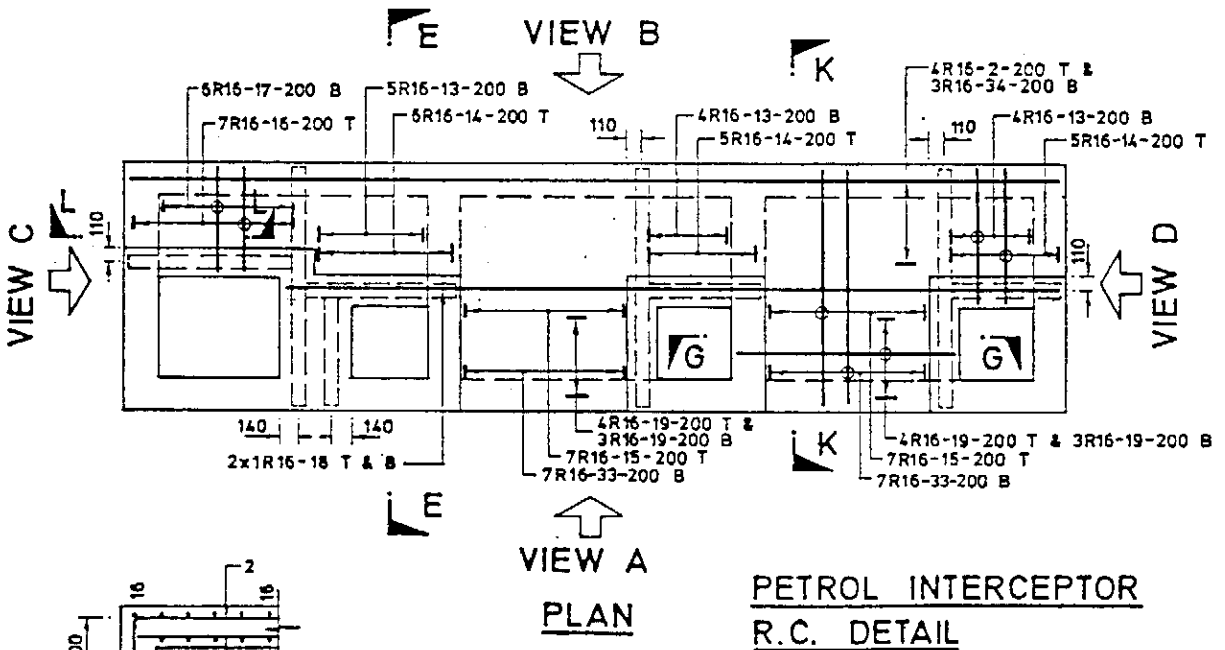
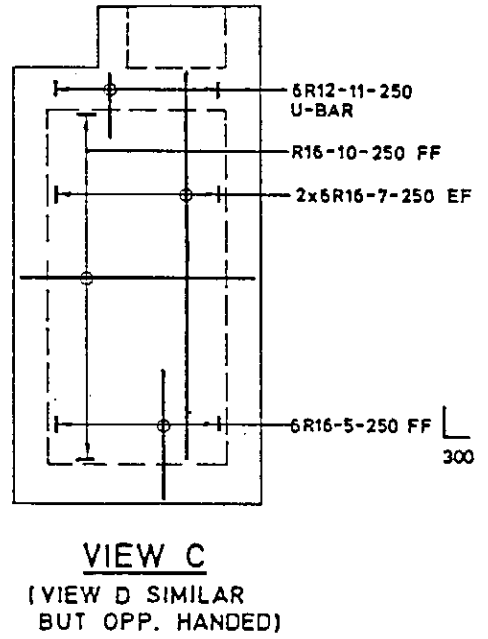
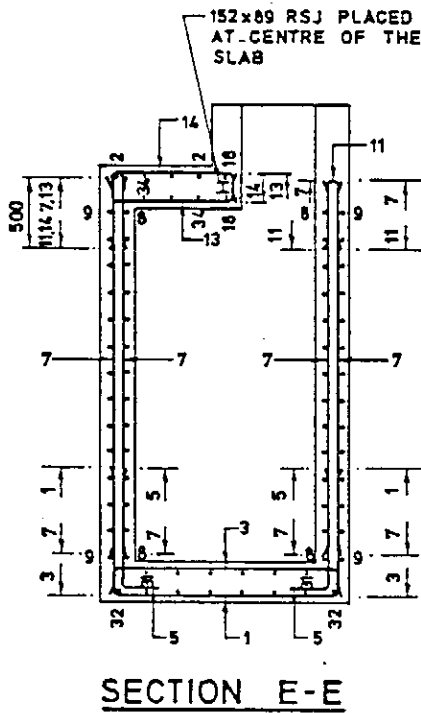

NEW ISSUE		NL	7/91
HIGHWAYS DEPARTMENT			
REFERENCE		DRAWING No.	
SCALE		H 3028/ 8	
1: 50			

NOTES :-
SEE H 3028/1 FOR GENERAL NOTES

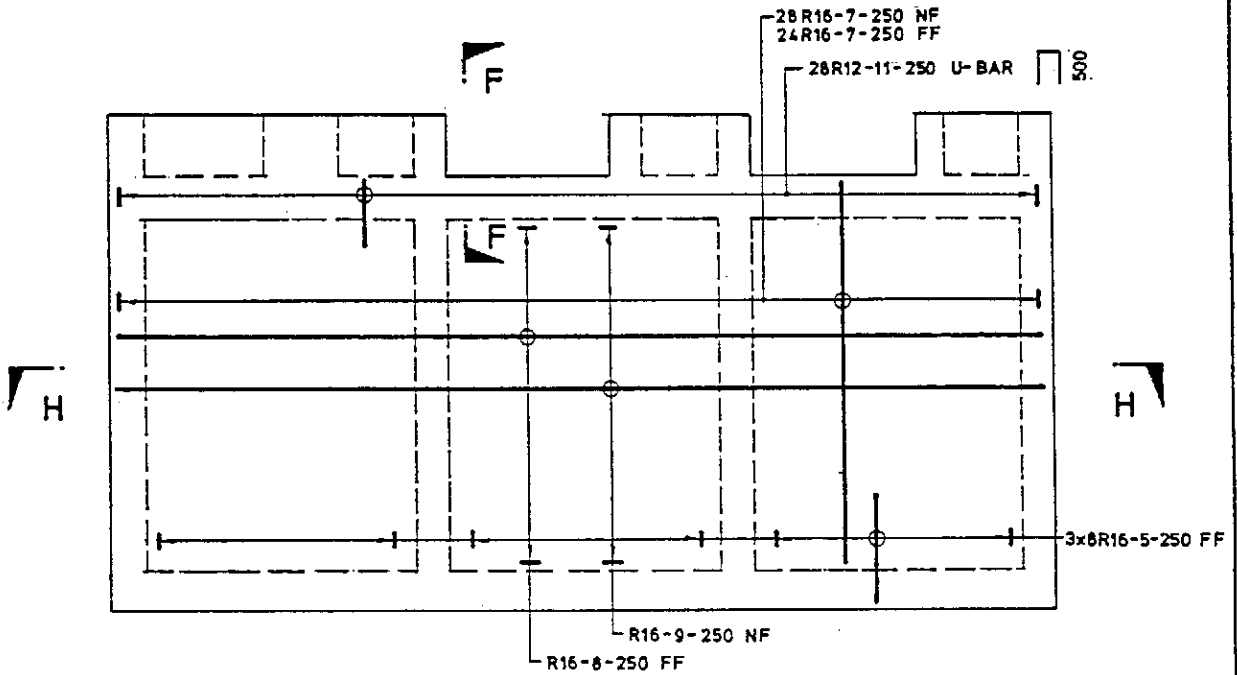

VIEW A

(VIEW B SIMILAR
BUT OPP. HANDED)

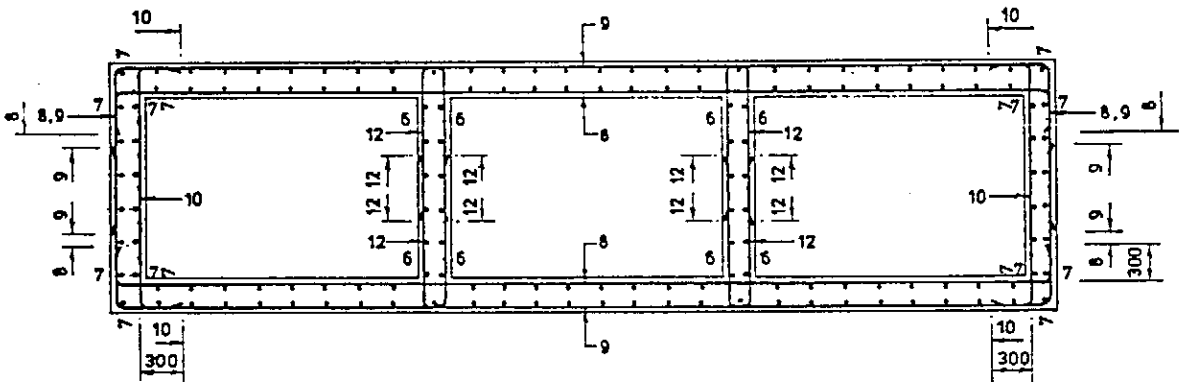

SECTION H-H

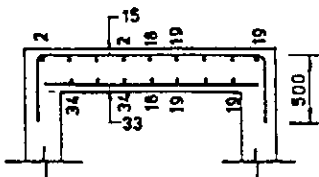

SECTION K-K

(NOTE : WALL BARS NOT
SHOWN FOR CLARITY)

NEW ISSUE		NL	7/91
HIGHWAYS DEPARTMENT			
REFERENCE		DRAWING No.	
SCALE		H 3028/9	
1 : 50			

NOTES :-
SEE H 3028 /1 FOR GENERAL NOTES

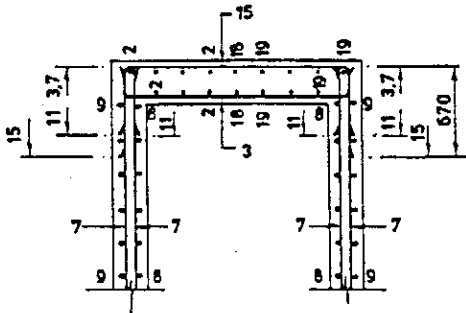

SECTION F-F

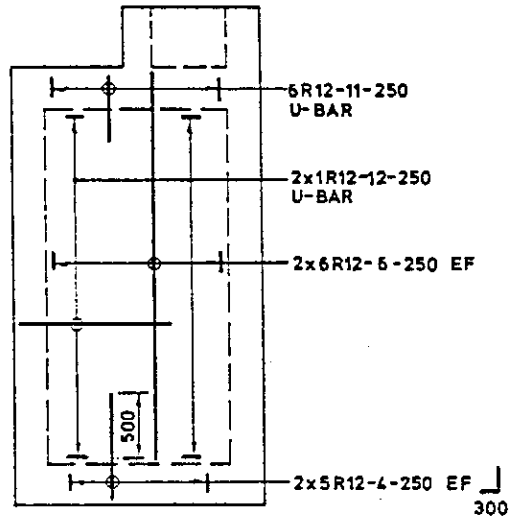

INTERNAL WALL

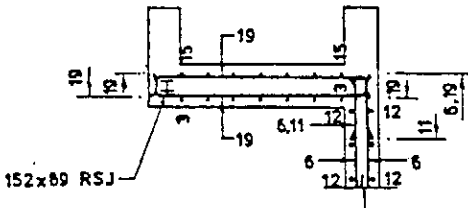

SECTION G-G

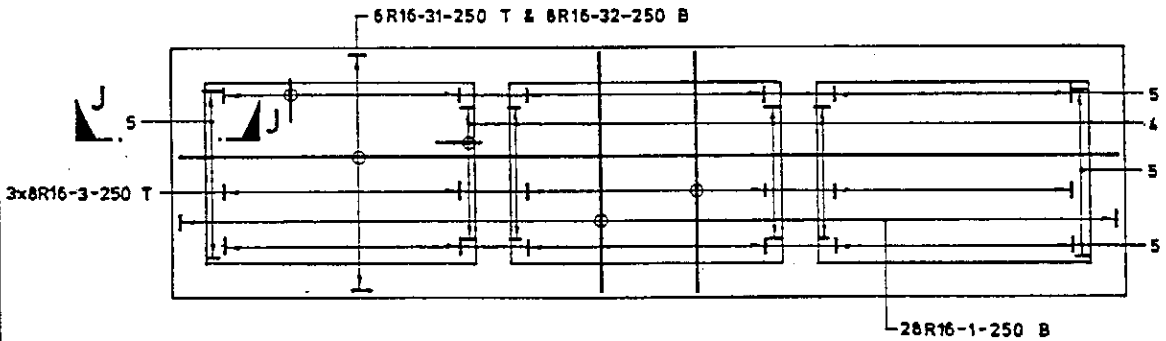

BASE SLAB

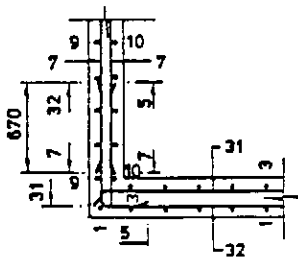

SECTION J-J

NEW ISSUE		NL	7/91
HIGHWAYS DEPARTMENT			
REFERENCE		DRAWING No.	
SCALE		H 3028/10	
1:50			

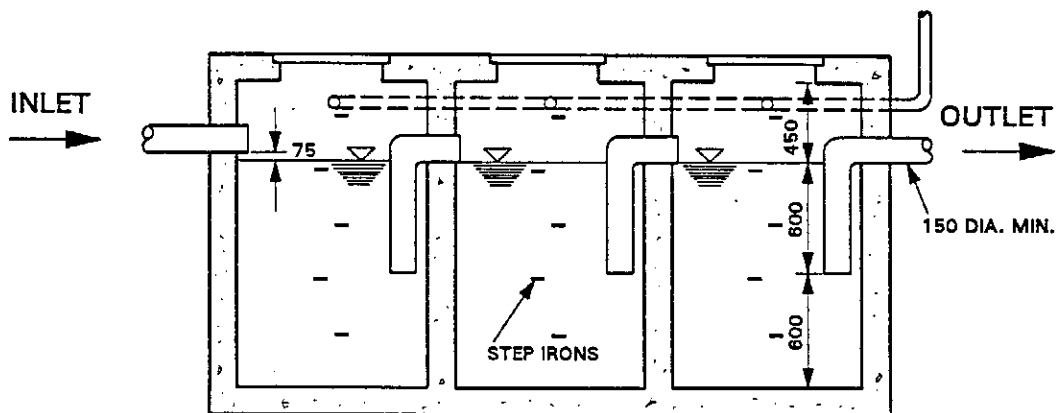

SECTION A - A

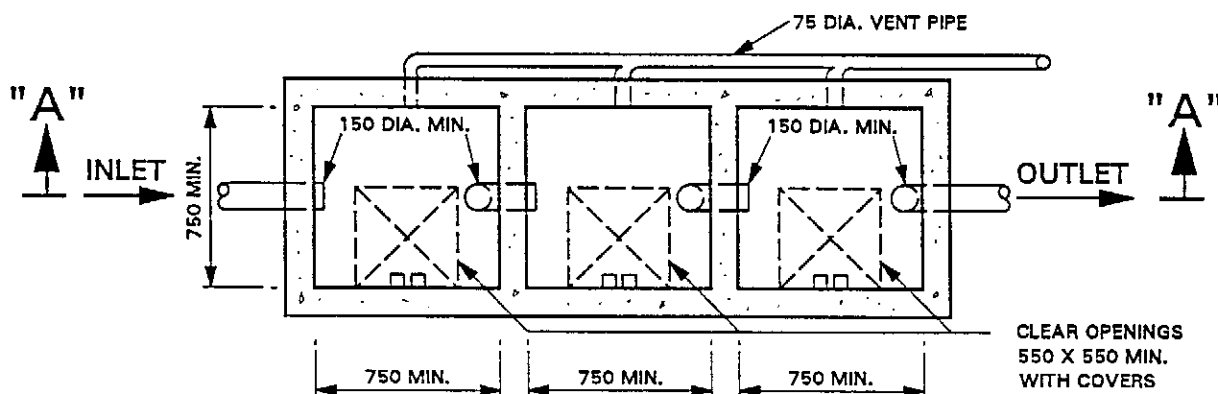

PLAN

NOTES :

1. ALL DIMENSIONS ARE IN MILLIMETRES

TYPICAL DETAILS OF
A PETROL INTERCEPTOR

drawing no.
EP 50/D1/1/01

group
Liquid Waste Projects

date
5/93

scale
NTS

ENVIRONMENTAL
PROTECTION
DEPARTMENT
HONG KONG



